

LM3668 Evaluation Board

[查询LM3668供应商](#)

National Semiconductor
Application Note 1623
Anne Lu
March 24, 2009



Introduction

The LM3668 evaluation board is a working demonstration of a synchronous buck-boost DC-DC converter. This application note contains information about the evaluation board. For more details and electrical characteristics about the converter operation, please refer to the datasheet.

Operating Range

- V_{IN} range: 2.5V to 5.5V
- For 2.8V/3.3V and 3.0V/3.4V versions:
 - 1A maximum load current for $V_{IN} = 2.8V$ to 5.5V
 - 800mA maximum load current for $V_{IN} = 2.7V$
 - 600mA maximum load current for $V_{IN} = 2.5V$
- For 4.5V/5V version:
 - 1A maximum load current for $V_{IN} = 3.9V$ to 5.5V
 - 800mA maximum load current for $V_{IN} = 3.4V$ to 3.8V
 - 700mA maximum load current for $V_{IN} = 3.0V$ to 3.3V
 - 600mA maximum load current for $V_{IN} = 2.7V$ to 2.9V

Package

LLP-12 no-pullback (3mm x 3mm x 0.8mm)

Typical Application

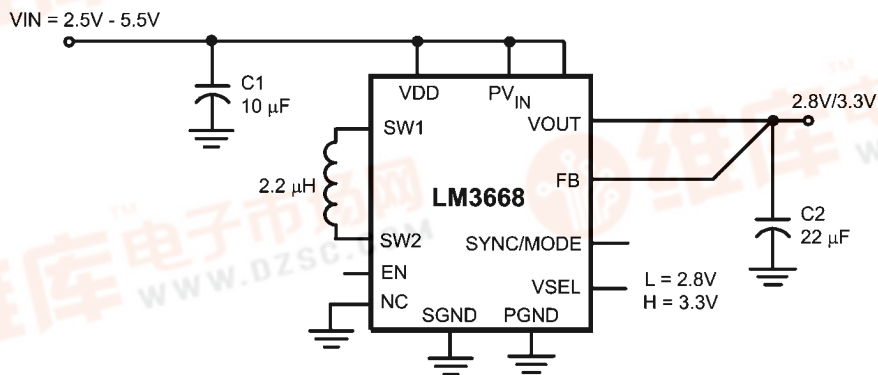
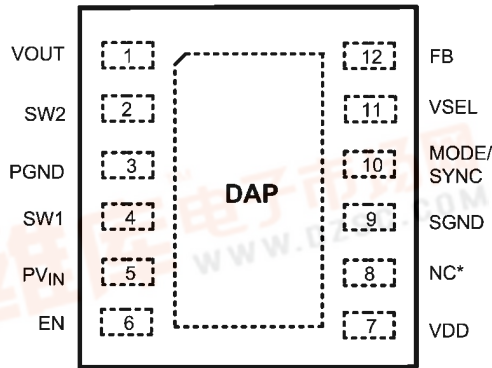

FIGURE 1. Typical Application Circuit

30018501

Connection Diagrams

查询LM3668应用商



30018502

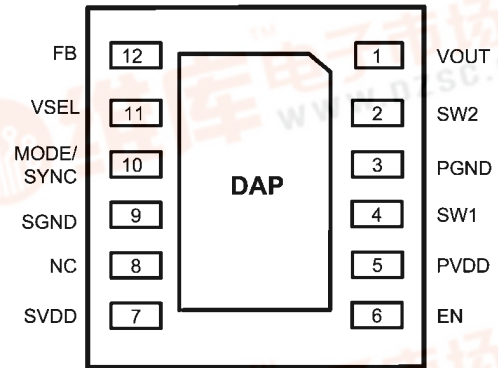

30018503

Note: the above figures are not to any actual scale

Pin Descriptions

Pin #	Pin Name	Description
1	VOUT	Connect to output capacitor.
2	SW2	Switching Node connection to the internal PFET switch (P2) and NFET synchronous rectifier (N2).
3	PGND	Power Ground.
4	SW1	Switching Node connection to the internal PFET switch (P1) and NFET synchronous rectifier (N1).
5	PV _{IN}	Supply to the power switch, connect to the input capacitor.
6	EN	Enable Input. Set this digital input high for normal operation. For shutdown, set low.
7	VDD	Signal Supply input. If board layout is not optimum an optional 1µF ceramic capacitor is suggested as close to this pin as possible.
8	NC	No connect. Connect this pin to SGND on PCB layout.
9	SGND	Analog and Control Ground.
10	MODE/SYNC	Mode = LOW, Automatic Mode. Mode= HI, Forced PWM Mode SYNC = external clock synchronization from 1.6MHz to 2.7MHz (When SYNC function is used, device is forced in PWM mode).
11	VSEL	Voltage selection pin; (i.e., 2.8V/3.3V option) Logic input low = 2.8V and logic high = 3.3V to set output Voltage.
12	FB	Feedback Analog Input. Connect to the output at the output filter.
DAP	DAP	Die Attach Pad, connect the DAP to SGND on PCB layout to enhance thermal performance. It should not be used as a primary ground connection.

Ordering Information

Order Number	Package	NSC Package Marking	Supplied As
LM3668SD - 2822	LLP-12	S016B	1000 units, Tape and Reel
LM3668SDX - 2833			4500 units, Tape and Reel
LM3668SD - 3034	LLP-12	S018B	1000 units, Tape and Reel
LM3668SDX - 3034			4500 units, Tape and Reel
LM3668SD - 4550	LLP-12	S019B	1000 units, Tape and Reel
LM3668SDX - 4550			4500 units, Tape and Reel

Note: As an example, if V_{OUT} option is 3.0V/3.4V, when V_{SEL} = Low, set V_{OUT} to 3V; when V_{SEL} = high, set V_{OUT} = 3.4V. This configuration applies to all voltage options.



Bill Of Materials

[查询LM3668供应商](#)

Component Name	Manufacturer	Specification	Case Size
LM3668SD	NSC	LLP-12	3mm x 3 mm x 0.8mm
$C_{IN} = 10\mu F$	Taiyo-Yuden	JMK212BJ106K	0805(2012)
$C_{OUT} = 22\mu F$ (2.8/3.3V, 3.0/3.4V)		JK212BJ226MG	0805(2012)
$C_{OUT} = 22\mu F$ (4.5/5.0V)		LMK212BJ226MMG	0805(2012)
$C_{IN-V_{DD}} = 4.7\mu F$		JMK212BJ475M	0805(2012)
Inductor	Coilcraft	LPS4018-222L	4mm x 4mm x 1.8mm

Operating Information

查询LM3668供应商

The LM3668 evaluation board is set for the following default positions:

- $V_{OUT} = 3.3V$, for $V_{OUT} = 2.8V$ move VSEL pin to Low via jumper
- SYNC Mode = H (PWM Mode), for Auto Mode, set SYNC = Low (move jumper to inner position). Do not leave this pin floating.
- EN pin is tied to V_{IN} via a jumper
- It is not recommended to start up the device with full load at minimum input voltage

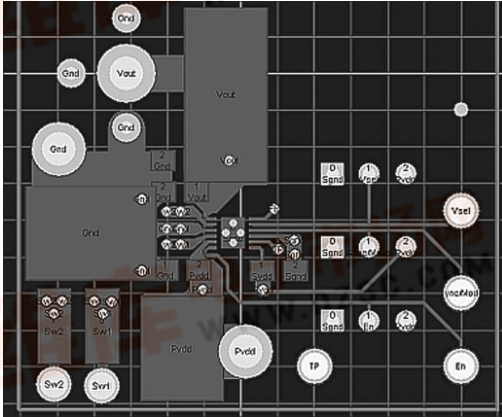

Top Layer

30018505

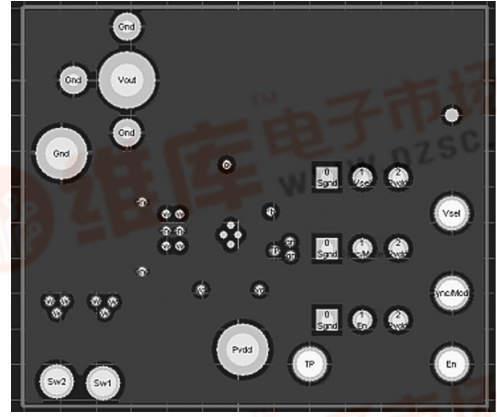

GND Inner Layer 1

30018517

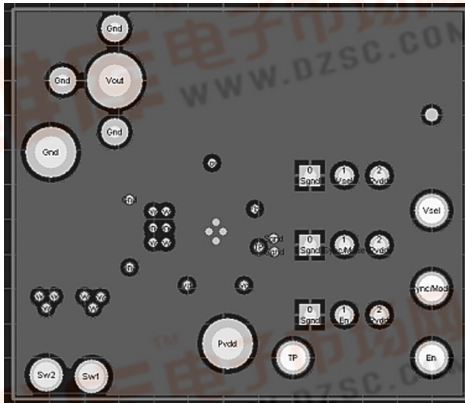

SGND Inner Layer 2

30018518

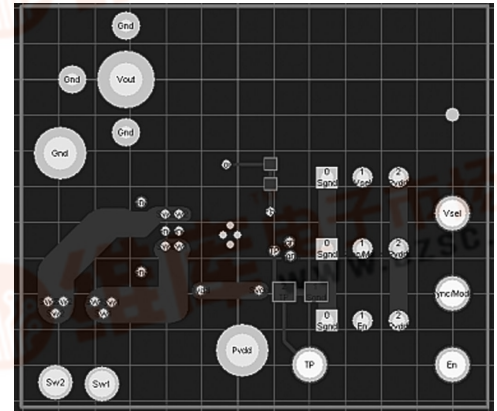

Bottom Layer

30018519

Evaluation Board Layout

LM3668EVB is a four-layer board designed to maximize the performance. Top layer consists of high current path; bottom layer is for low current and logic signals path. Inner layer 1 and layer 2 are dedicated for PGND (power GND) and SGND (analog and logic GND). For optimum performance, it is recommended to separate the PGND & SGND pins and join them together at the "star GND" on the PCB. The star GND traces on the PCB board should be close to the device power GND pin.

[查询LM3668供应商](#)

Notes

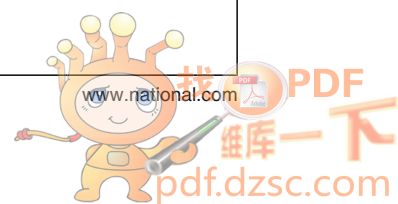

[查询LM3668供应商](#)

Notes

For more National Semiconductor product information and proven design tools, visit the following Web sites at:

Products		Design Support	
Amplifiers	www.national.com/amplifiers	WEBENCH® Tools	www.national.com/webench
Audio	www.national.com/audio	App Notes	www.national.com/appnotes
Clock and Timing	www.national.com/timing	Reference Designs	www.national.com/refdesigns
Data Converters	www.national.com/adc	Samples	www.national.com/samples
Interface	www.national.com/interface	Eval Boards	www.national.com/evalboards
LVDS	www.national.com/lvds	Packaging	www.national.com/packaging
Power Management	www.national.com/power	Green Compliance	www.national.com/quality/green
Switching Regulators	www.national.com/switchers	Distributors	www.national.com/contacts
LDOs	www.national.com/ldo	Quality and Reliability	www.national.com/quality
LED Lighting	www.national.com/led	Feedback/Support	www.national.com/feedback
Voltage Reference	www.national.com/vref	Design Made Easy	www.national.com/easy
PowerWise® Solutions	www.national.com/powerwise	Solutions	www.national.com/solutions
Serial Digital Interface (SDI)	www.national.com/sdi	Mil/Aero	www.national.com/milaero
Temperature Sensors	www.national.com/tempsensors	SolarMagic™	www.national.com/solarmagic
Wireless (PLL/VCO)	www.national.com/wireless	Analog University®	www.national.com/AU

THE CONTENTS OF THIS DOCUMENT ARE PROVIDED IN CONNECTION WITH NATIONAL SEMICONDUCTOR CORPORATION ("NATIONAL") PRODUCTS. NATIONAL MAKES NO REPRESENTATIONS OR WARRANTIES WITH RESPECT TO THE ACCURACY OR COMPLETENESS OF THE CONTENTS OF THIS PUBLICATION AND RESERVES THE RIGHT TO MAKE CHANGES TO SPECIFICATIONS AND PRODUCT DESCRIPTIONS AT ANY TIME WITHOUT NOTICE. NO LICENSE, WHETHER EXPRESS, IMPLIED, ARISING BY ESTOPPEL OR OTHERWISE, TO ANY INTELLECTUAL PROPERTY RIGHTS IS GRANTED BY THIS DOCUMENT.

TESTING AND OTHER QUALITY CONTROLS ARE USED TO THE EXTENT NATIONAL DEEMS NECESSARY TO SUPPORT NATIONAL'S PRODUCT WARRANTY. EXCEPT WHERE MANDATED BY GOVERNMENT REQUIREMENTS, TESTING OF ALL PARAMETERS OF EACH PRODUCT IS NOT NECESSARILY PERFORMED. NATIONAL ASSUMES NO LIABILITY FOR APPLICATIONS ASSISTANCE OR BUYER PRODUCT DESIGN. BUYERS ARE RESPONSIBLE FOR THEIR PRODUCTS AND APPLICATIONS USING NATIONAL COMPONENTS. PRIOR TO USING OR DISTRIBUTING ANY PRODUCTS THAT INCLUDE NATIONAL COMPONENTS, BUYERS SHOULD PROVIDE ADEQUATE DESIGN, TESTING AND OPERATING SAFEGUARDS.

EXCEPT AS PROVIDED IN NATIONAL'S TERMS AND CONDITIONS OF SALE FOR SUCH PRODUCTS, NATIONAL ASSUMES NO LIABILITY WHATSOEVER, AND NATIONAL DISCLAIMS ANY EXPRESS OR IMPLIED WARRANTY RELATING TO THE SALE AND/OR USE OF NATIONAL PRODUCTS INCLUDING LIABILITY OR WARRANTIES RELATING TO FITNESS FOR A PARTICULAR PURPOSE, MERCHANTABILITY, OR INFRINGEMENT OF ANY PATENT, COPYRIGHT OR OTHER INTELLECTUAL PROPERTY RIGHT.

LIFE SUPPORT POLICY

NATIONAL'S PRODUCTS ARE NOT AUTHORIZED FOR USE AS CRITICAL COMPONENTS IN LIFE SUPPORT DEVICES OR SYSTEMS WITHOUT THE EXPRESS PRIOR WRITTEN APPROVAL OF THE CHIEF EXECUTIVE OFFICER AND GENERAL COUNSEL OF NATIONAL SEMICONDUCTOR CORPORATION. As used herein:

Life support devices or systems are devices which (a) are intended for surgical implant into the body, or (b) support or sustain life and whose failure to perform when properly used in accordance with instructions for use provided in the labeling can be reasonably expected to result in a significant injury to the user. A critical component is any component in a life support device or system whose failure to perform can be reasonably expected to cause the failure of the life support device or system or to affect its safety or effectiveness.

National Semiconductor and the National Semiconductor logo are registered trademarks of National Semiconductor Corporation. All other brand or product names may be trademarks or registered trademarks of their respective holders.

Copyright© 2009 National Semiconductor Corporation

For the most current product information visit us at www.national.com



National Semiconductor
Americas Technical
Support Center
Email: support@nsc.com
Tel: 1-800-272-9959

National Semiconductor Europe
Technical Support Center
Email: europe.support@nsc.com

National Semiconductor Asia
Pacific Technical Support Center
Email: ap.support@nsc.com

National Semiconductor Japan
Technical Support Center
Email: jpn.feedback@nsc.com