

STEP-UP, 1.2 MHz HIGH-FREQUENCY, PWM CONTROL SWITCHING REGULATOR CONTROLLER

www.sii-ic.com

© Seiko Instruments Inc., 2003-2010

Rev.4.0_00

The S-8337/8338 Series is a CMOS step-up switching regulator which mainly consists of a reference voltage circuit, an oscillator, an error amplifier, a PWM controller, an under voltage lockout circuit (UVLO), and a timer latch short-circuit protection circuit. Because its minimum operating voltage is as low as 1.8 V, this switching regulator is ideal for the power supply of an LCD or for portable systems that operate on a low voltage. The internal oscillation frequency can be set up to 1.133 MHz, via the resistor connected to the ROSC pin.

With the S-8337 Series, the maximum duty ratio of PWM control can be controlled by the resistor connected to the RDuty pin. With the S-8338 Series, the maximum duty ratio is fixed (to 88%). The phase compensation and gain value can be adjusted according to the values of the resistor and capacitor connected to the CC pin. Therefore, the operation stability and transient response can be correctly set for each application. The reference voltage accuracy is as high as $1.0 V \pm 1.5\%$, and any voltage can be output by using an external output voltage setting resistor.

In addition, the delay time of the short-circuit protection circuit can be set by using the capacitor connected to the CSP pin. If the maximum duty condition continues because of short-circuiting, the capacitor externally connected to the CSP pin is charged, and oscillation stops after a specific time. This condition is cleared by re-application of power or by setting the switching regulator (S-8338 Series) to the shutdown status. A ceramic capacitor or a tantalum capacitor is used as the output capacitor, depending on the setting. This controller IC allows various settings and selections and employs a small package, making it very easy to use.

■ Features

- Low voltage operation: 1.8 V to 6.0 V
- Oscillation frequency: 286 kHz to 1.133 MHz (selectable by external resistor)
- Maximum duty: 47 to 88.5% (selectable by external resistor) (S-8337 Series)
Fixed to 88% typ. (S-8338 Series)
- Reference voltage: $1.0 V \pm 1.5\%$
- UVLO (under-voltage lockout) function:
Detection voltage can be selected from between 1.5 V and 2.3 V in 0.1 V steps.
Hysteresis width can be selected from between 0.1 V and 0.3 V in 0.1 V steps.
- Timer latch short-circuit protection circuit:
Delay time can be set using an external capacitor.
- Soft-start function: Soft-start time can be selected in three steps, 10 ms, 15 ms, and 20 ms.
- Phase compensation external setting:
Adjustable by connecting resistor and capacitor in series to GND.
- Shutdown function: S-8338 Series, shutdown current consumption: 1.0 μ A max.
- Lead-free, Sn 100%, halogen-free^{*1}

*1. Refer to "■ Product Name Structure" for details.

■ Applications

- Power supplies for LCDs and CCDs
- Power supplies for portable equipment

■ Packages

- 8-Pin SON(A)
- 8-Pin TSSOP

■ Block Diagram

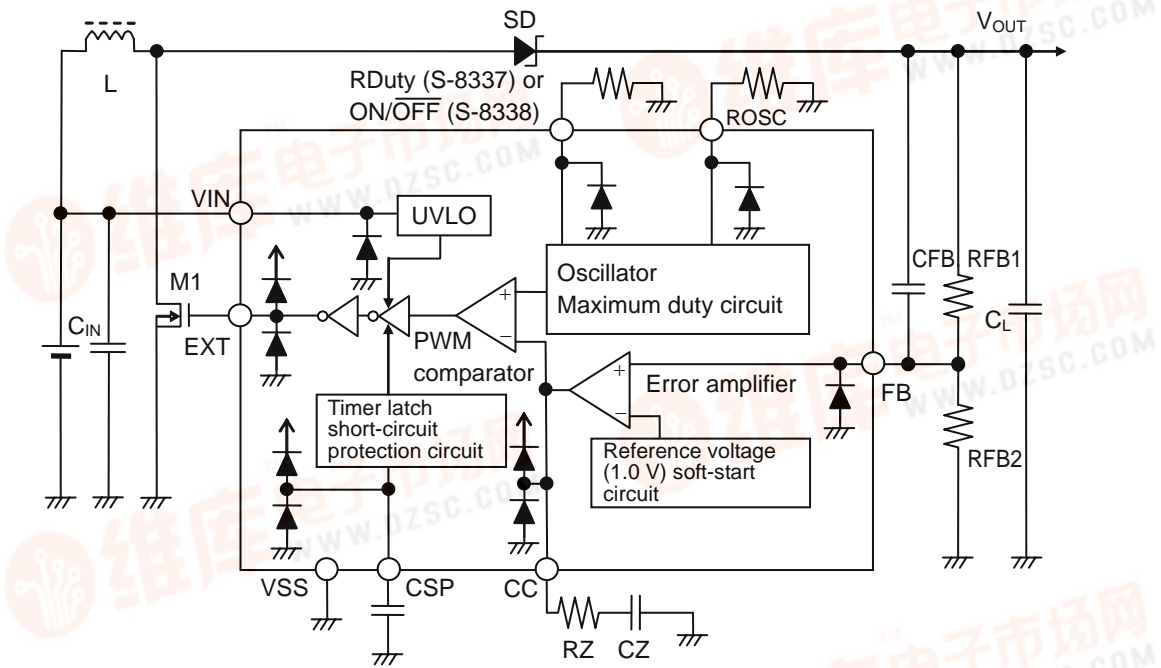

Figure 1 Block Diagram



■ Product Name Structure

1. Product name

(1) 8-Pin SON(A)

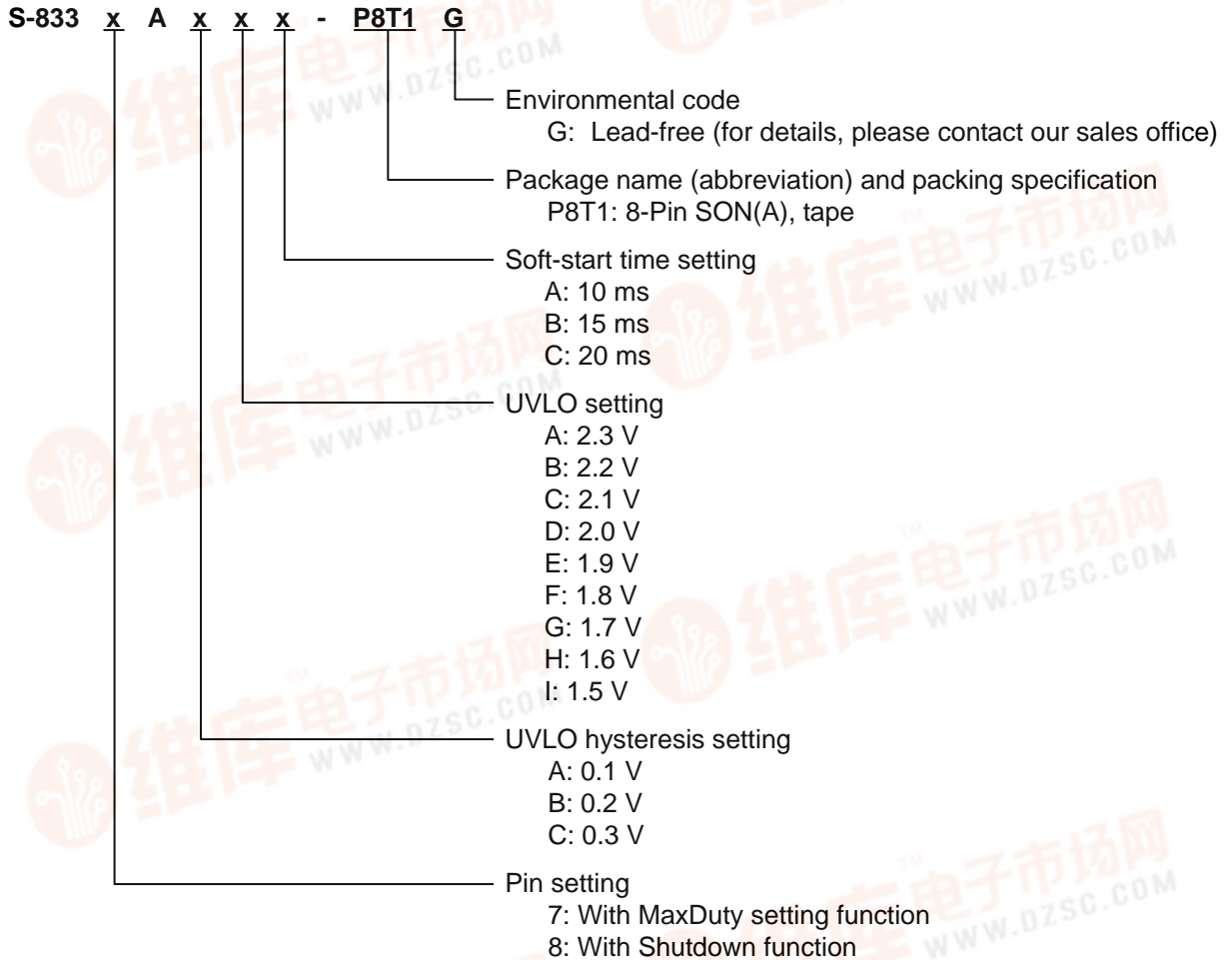

(2) 8-Pin TSSOP

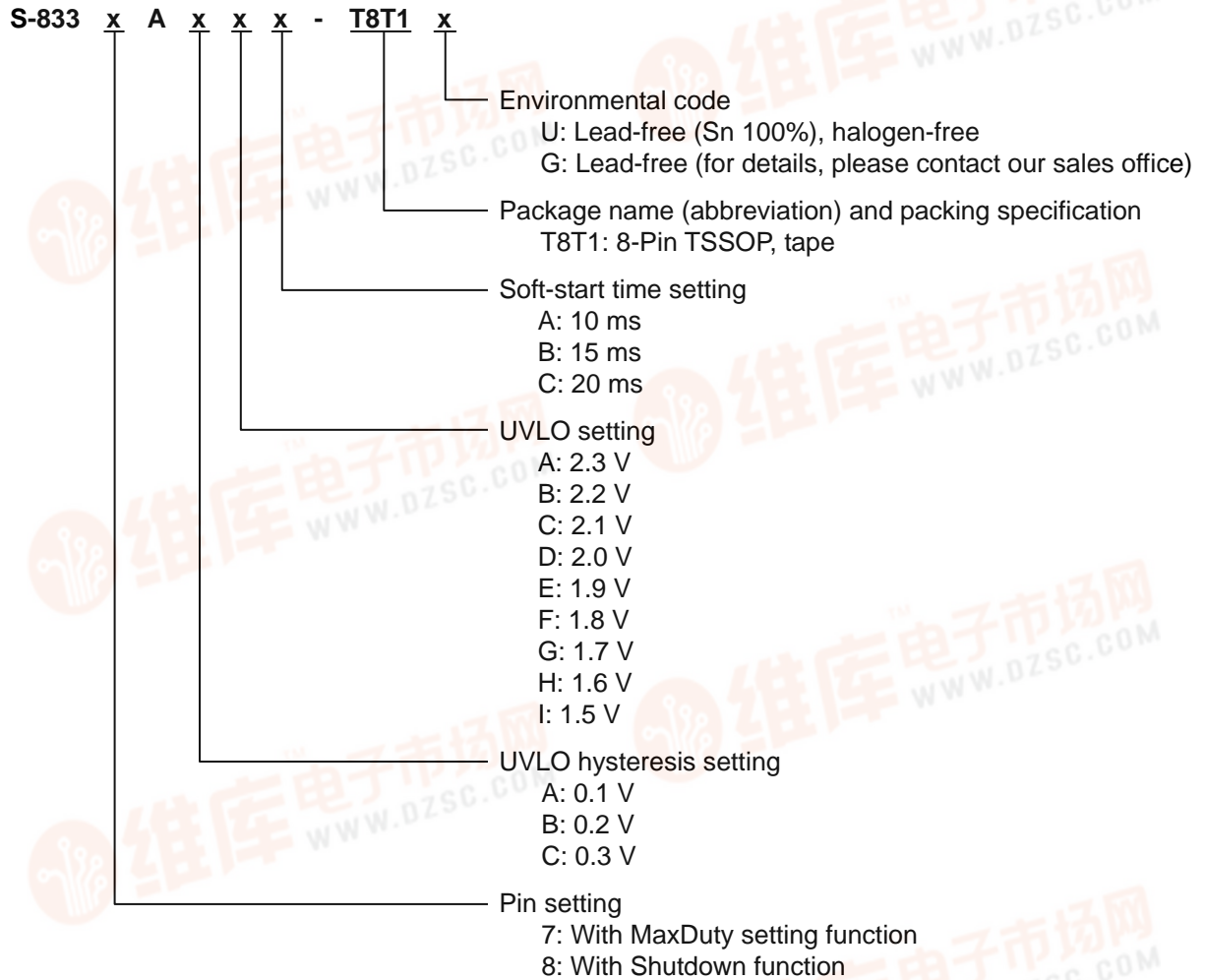

2. Packages

Package Name	Drawing Code			
	Package	Tape	Reel	
8-Pin SON(A)	PN008-A-P-SD	PN008-A-C-SD	PN008-A-R-SD	
8-Pin TSSOP	Environmental code = G	FT008-A-P-SD	FT008-E-C-SD	FT008-E-R-SD
	Environmental code = U	FT008-A-P-SD	FT008-E-C-SD	FT008-E-R-S1



■ Pin Configurations

Table 1

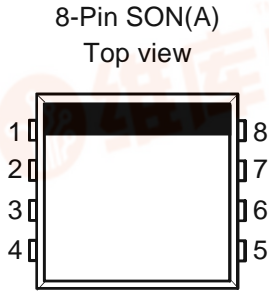

Figure 2

Pin No.	Symbol	Description
1	CC	Error amplifier circuit output phase compensation pin
2	FB	Output voltage feedback pin
3	CSP	Short-circuit protection delay time setting pin
4	VIN	Power supply input pin
5	EXT	External transistor connection pin
6	VSS	GND pin
7	ROSC	Oscillation frequency setting resistor connection pin
8	RDuty	Maximum duty setting resistor connection pin (S-8337 Series)
	ON/OFF	Shutdown pin (S-8338 Series)

Table 2

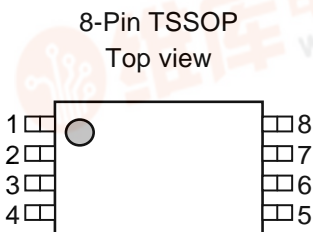

Figure 3

Pin No.	Symbol	Description
1	CC	Error amplifier circuit output phase compensation pin
2	FB	Output voltage feedback pin
3	CSP	Short-circuit protection delay time setting pin
4	VIN	Power supply input pin
5	EXT	External transistor connection pin
6	VSS	GND pin
7	ROSC	Oscillation frequency setting resistor connection pin
8	RDuty	Maximum duty setting resistor connection pin (S-8337 Series)
	ON/OFF	Shutdown pin (S-8338 Series)

■ Absolute Maximum Ratings

Table 3 Absolute Maximum Ratings

(Unless otherwise specified: Ta = 25°C, VSS = 0 V)

Parameter	Symbol	Absolute Maximum Rating	Unit	
VIN pin voltage	V _{IN}	V _{SS} - 0.3 to V _{SS} + 6.5	V	
FB pin voltage	V _{FB}	V _{SS} - 0.3 to V _{SS} + 6.5	V	
EXT pin voltage	V _{EXT}	V _{SS} - 0.3 to V _{IN} + 0.3	V	
CSP pin voltage	V _{CSP}	V _{SS} - 0.3 to V _{IN} + 0.3	V	
CC pin voltage	V _{CC}	V _{SS} - 0.3 to V _{IN} + 0.3	V	
CC pin current	I _{CC}	±10	mA	
ROSC pin voltage	V _{ROSC}	V _{SS} - 0.3 to V _{IN} + 0.3	V	
ROSC pin current	I _{ROSC}	±10	mA	
RDuty pin voltage	V _{RDuty}	V _{SS} - 0.3 to V _{IN} + 0.3	V	
RDuty pin current	I _{RDuty}	±10	mA	
ON/OFF pin voltage	V _{ON/OFF}	V _{SS} - 0.3 to V _{SS} + 6.5	V	
Power dissipation	8-Pin SON(A)	P _D	300 (When not mounted on board)	mW
			600*1	mW
	8-Pin TSSOP		300 (When not mounted on board)	mW
			700*1	mW
Operating ambient temperature	T _{opr}	-40 to +85	°C	
Storage temperature	T _{stg}	-40 to +125	°C	

*1. When mounted on board

[Mounted board]

- (1) Board size : 114.3 mm × 76.2 mm × t1.6 mm
- (2) Board name : JEDEC STANDARD51-7

Caution The absolute maximum ratings are rated values exceeding which the product could suffer physical damage. These values must therefore not be exceeded under any conditions.

(1) When mounted on board

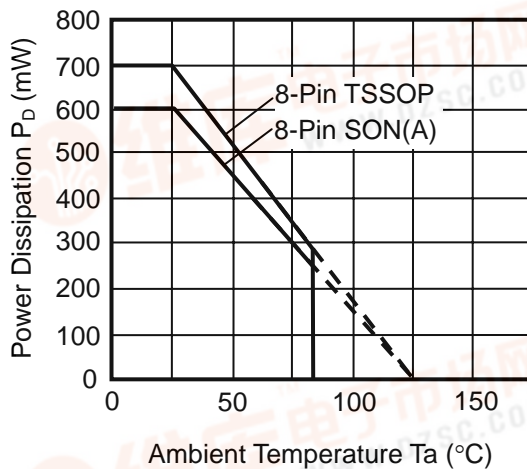

(2) When not mounted on board

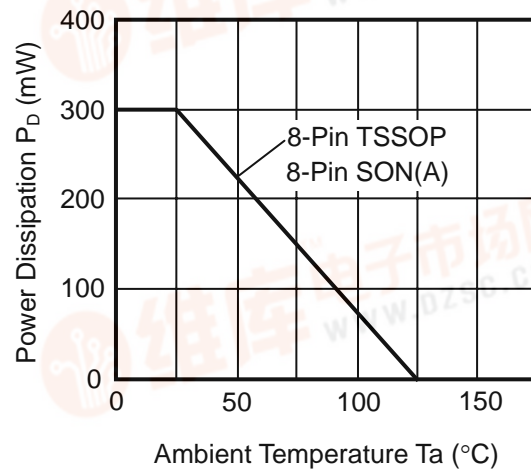

Figure 4 Power Dissipation of Package



Electrical Characteristics

1. S-8337 Series

Table 4 Electrical Characteristics

(Unless otherwise specified: $V_{IN} = 3.3\text{ V}$, $T_a = 25^\circ\text{C}$)

Parameter	Symbol	Conditions	Min.	Typ.	Max.	Unit	Test Circuit
Operating input voltage	V_{IN}	—	1.8	—	6.0	V	2
FB voltage	V_{FB}	—	0.985	1.000	1.015	V	2
Current consumption	I_{SS1}	$f_{osc} = 700\text{ kHz}$ $V_{FB} = 0.95\text{ V}$	—	400	700	μA	1
EXT pin output current	I_{EXTH}	$V_{EXT} = V_{IN} - 0.4\text{ V}$	—	-100	-60	mA	1
	I_{EXTL}	$V_{EXT} = 0.4\text{ V}$	100	160	—	mA	1
FB voltage temperature coefficient	$\frac{\Delta V_{FB}}{\Delta T_a}$	$T_a = -40^\circ\text{C}$ to $+85^\circ\text{C}$	—	± 100	—	ppm/ $^\circ\text{C}$	2
FB pin input current	I_{FB}	—	-0.1	—	+0.1	μA	1
Oscillation frequency*1	f_{osc}	$f_{osc} = 1133\text{ kHz}$ ($R_{OSC} = 120\text{ k}\Omega$) $f_{osc} = 700\text{ kHz}$ ($R_{OSC} = 200\text{ k}\Omega$) $f_{osc} = 286\text{ kHz}$ ($R_{OSC} = 510\text{ k}\Omega$) $V_{FB} = 0.9\text{ V}$ Waveform on EXT pin is measured.	$f_{osc} \times 0.9$	f_{osc}	$f_{osc} \times 1.1$	kHz	1
Oscillation frequency temperature coefficient	$\frac{\Delta f_{osc}}{\Delta T_a}$	$T_a = -40^\circ\text{C}$ to $+85^\circ\text{C}$ $f_{osc} = 700\text{ kHz}$	—	1000	—	ppm/ $^\circ\text{C}$	1
Max. duty*2	MaxDuty	$f_{osc} = 700\text{ kHz}$ ($R_{OSC} = 200\text{ k}\Omega$) MaxDuty = 88.5% ($R_{Duty} = 100\text{ k}\Omega$) MaxDuty = 77% ($R_{Duty} = 300\text{ k}\Omega$) MaxDuty = 47% ($R_{Duty} = 820\text{ k}\Omega$)	MaxDuty - 5	MaxDuty	MaxDuty + 5	%	1
Soft-start time	t_{SS}	$t_{SS} = 10\text{ ms}$, 15 ms , 20 ms Selected in three steps	$t_{SS} \times 0.75$	t_{SS}	$t_{SS} \times 1.5$	ms	1
Short-circuit protection delay time*3	t_{PRO}	$t_{PRO} = 50\text{ ms}$ (CSP = $0.1\text{ }\mu\text{F}$)	37.5	50	75	ms	1
UVLO detection voltage	V_{UVLO}	$V_{UVLO} = 1.5\text{ V}$ to 2.3 V Selected in 0.1 V steps	$V_{UVLO} \times 0.95$	V_{UVLO}	$V_{UVLO} \times 1.05$	V	1
UVLO hysteresis width	$V_{UVLOHYS}$	$V_{UVLOHYS} = 0.1\text{ V}$ to 0.3 V Selected in 0.1 V steps	$V_{UVLOHYS} \times 0.6$	$V_{UVLOHYS}$	$V_{UVLOHYS} \times 1.4$	mV	1
CC pin output current	I_{CCH}	$V_{FB} = 2\text{ V}$	-75	-50	-37.5	μA	1
	I_{CCL}	$V_{FB} = 0\text{ V}$	37.5	50	75	μA	1
Timer latch reset voltage	V_{RTLTL}	—	0.7	1.0	1.3	V	1

- *1. The recommended range of the resistance (R_{osc}) for setting the oscillation frequency is $R_{osc} = 120\text{ k}\Omega$ to $510\text{ k}\Omega$ ($f_{osc} = 286\text{ kHz}$ to 1.133 MHz). However, the oscillation frequency is in the range of typical values when an ideal resistor is externally connected, so actually the fluctuation of the IC ($\pm 10\%$) must be considered.
- *2. The recommended range of the resistance (R_{Duty}/R_{osc}) for setting the maximum duty is $R_{Duty}/R_{osc} = 0.5$ to 4.1 (MaxDuty = 47 to 88.5%). However, the maximum duty is in the range of typical values when an ideal resistor is externally connected, so actually the fluctuation of the IC ($\pm 5\%$) must be considered.
- *3. The short-circuit protection time can be set by the external capacitor, and the maximum set value by the external capacitor is unlimited when an ideal case is assumed. But, use $C_{SP} =$ approximately $0.47\text{ }\mu\text{F}$ as a target maximum value due to the need to consider the discharge time of the capacitor.

2. S-8338 Series

Table 5 Electrical Characteristics

(Unless otherwise specified: $V_{IN} = 3.3\text{ V}$, $T_a = 25^\circ\text{C}$)

Parameter	Symbol	Conditions	Min.	Typ.	Max.	Unit	Test Circuit
Operating input voltage	V_{IN}	—	1.8	—	6.0	V	2
FB voltage	V_{FB}	—	0.985	1.000	1.015	V	2
Current consumption	I_{SS1}	$f_{osc} = 700\text{ kHz}$ $V_{FB} = 0.95\text{ V}$	—	400	700	μA	1
Shutdown current consumption	I_{SSS}	$V_{IN} = 6.0\text{ V}$	—	—	1.0	μA	1
EXT pin output current	I_{EXTH}	$V_{EXT} = V_{IN} - 0.4\text{ V}$	—	-100	-60	mA	1
	I_{EXTL}	$V_{EXT} = 0.4\text{ V}$	100	160	—	mA	1
FB voltage temperature coefficient	$\frac{\Delta V_{FB}}{\Delta T_a}$	$T_a = -40^\circ\text{C}$ to $+85^\circ\text{C}$	—	± 100	—	ppm/ $^\circ\text{C}$	2
FB pin input current	I_{FB}	—	-0.1	—	+0.1	μA	1
Oscillation frequency ^{*1}	f_{osc}	$f_{osc} = 1133\text{ kHz}$ ($R_{OSC} = 120\text{ k}\Omega$) $f_{osc} = 700\text{ kHz}$ ($R_{OSC} = 200\text{ k}\Omega$) $f_{osc} = 286\text{ kHz}$ ($R_{OSC} = 510\text{ k}\Omega$) $V_{FB} = 0.9\text{ V}$ Waveform on EXT pin is measured	$f_{osc} \times 0.9$	f_{osc}	$f_{osc} \times 1.1$	kHz	1
Oscillation frequency temperature coefficient	$\frac{\Delta f_{osc}}{\Delta T_a}$	$T_a = -40^\circ\text{C}$ to $+85^\circ\text{C}$ $f_{osc} = 700\text{ kHz}$	—	1000	—	ppm/ $^\circ\text{C}$	1
Max. duty ratio	MaxDuty	$f_{osc} = 700\text{ kHz}$ ($R_{OSC} = 200\text{ k}\Omega$)	83	88	93	%	1
Soft-start time	t_{SS}	$t_{SS} = 10\text{ ms}$, 15 ms , 20 ms Selectable in three steps	$t_{SS} \times 0.75$	t_{SS}	$t_{SS} \times 1.5$	ms	1
Short-circuit protection delay time ^{*2}	t_{PRO}	$t_{PRO} = 50\text{ ms}$ ($C_{SP} = 0.1\text{ }\mu\text{F}$)	37.5	50	75	ms	1
UVLO detection voltage	V_{UVLO}	$V_{UVLO} = 1.5\text{ V}$ to 2.3 V Selected in 0.1 V steps	$V_{UVLO} \times 0.95$	V_{UVLO}	$V_{UVLO} \times 1.05$	V	1
UVLO hysteresis width	$V_{UVLOHYS}$	$V_{UVLOHYS} = 0.1\text{ V}$ to 0.3 V Selected in 0.1 V steps	$V_{UVLOHYS} \times 0.6$	$V_{UVLOHYS}$	$V_{UVLOHYS} \times 1.4$	mV	1
CC pin output current	I_{CCH}	$V_{FB} = 2\text{ V}$	-75	-50	-37.5	μA	1
	I_{CCL}	$V_{FB} = 0\text{ V}$	37.5	50	75	μA	1
Timer latch reset voltage	V_{RTLTL}	—	0.7	1.0	1.3	V	1
Shutdown pin input voltage (High level)	V_{SH}	—	1.8	—	—	V	1
Shutdown pin input voltage (Low level)	V_{SL}	—	—	—	0.3	V	1
Shutdown pin input current (High level)	I_{SH}	—	-0.1	—	+0.1	μA	1
Shutdown pin input current (Low level)	I_{SL}	—	-0.1	—	+0.1	μA	1

*1. The recommended range of the resistance (R_{osc}) for setting the oscillation frequency is $R_{osc} = 120\text{ k}\Omega$ to $510\text{ k}\Omega$ ($f_{osc} = 286\text{ kHz}$ to 1.133 MHz). However, the oscillation frequency is in the range of typical values when an ideal resistor is externally connected, so actually the fluctuation of the IC ($\pm 10\%$) must be considered.

*2. The short-circuit protection time can be set by the external capacitor, and the maximum set value by the external capacitor is unlimited when an ideal case is assumed. But, use $C_{SP} =$ approximately $0.47\text{ }\mu\text{F}$ as a target maximum value due to the need to consider the discharge time of the capacitor.



■ External Parts When Measuring Electrical Characteristics

Table 6 External Parts

Element Name	Symbol	Manufacturer	Part Number
Inductor	L	TDK Corporation	LDR655312T 4.7 μ H
Diode	SD	Rohm Co., Ltd.	RB491D
Output capacitor	CL	—	Ceramic 10 μ F
Transistor	M1	Sanyo Electric Co., Ltd.	MCH3406
Oscillation frequency setting resistor	ROSC	—	200 k Ω (when $f_{OSC} = 700$ kHz)
Maximum duty ratio setting resistor	RDuty	—	300 k Ω (when MaxDuty = 77%)
Short-circuit protection delay time setting capacitor	CSP	—	0.1 μ F (when $t_{PRO} = 50$ ms)
Output voltage setting resistor 1	RFB1	—	8.2 k Ω (when $V_{OUT} = 9.2$ V)
Output voltage setting resistor 2	RFB2	—	1.0 k Ω (when $V_{OUT} = 9.2$ V)
FB pin capacitor	CFB	—	180 pF
Phase compensation resistor	RZ	—	200 k Ω
Phase compensation capacitor	CZ	—	0.01 μ F

■ Measurement Circuits

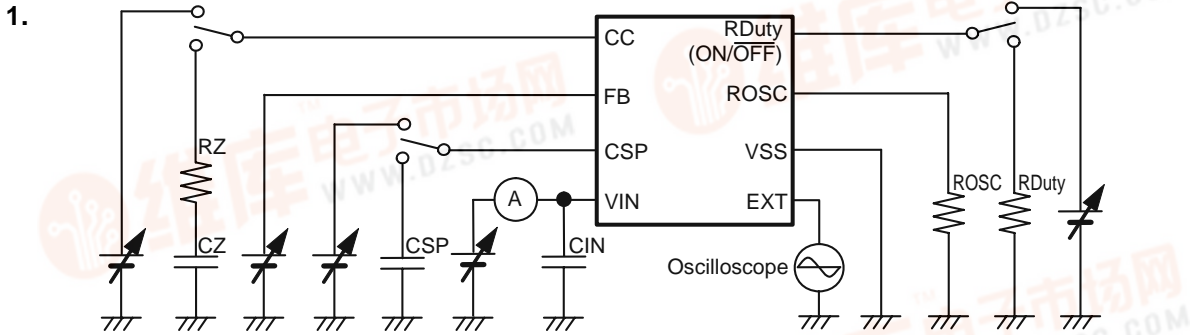

Figure 5

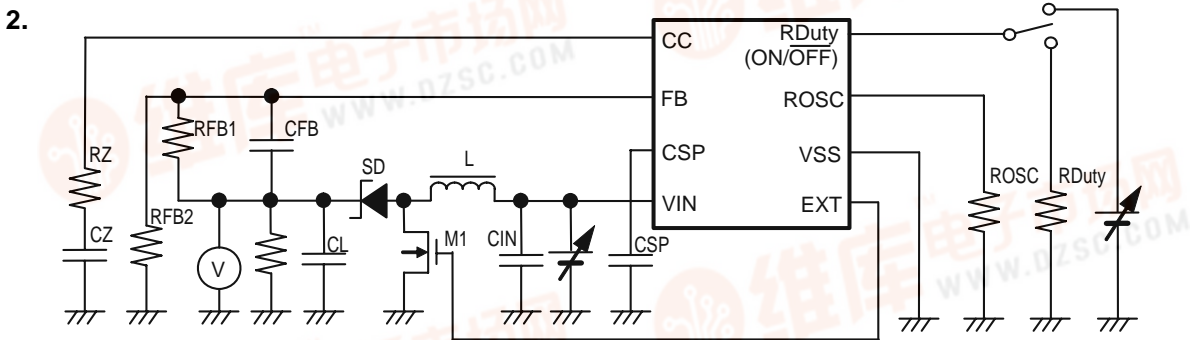
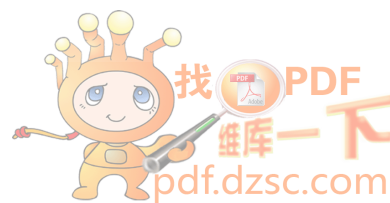

Figure 6



■ Operation

1. Switching control method

PWM control (S-8337/8338 Series)

The S-8337/8338 Series is a DC-DC converter using a pulse width modulation method (PWM).

The pulse width of the S-8337/8338 Series varies from 0% to the maximum duty set by RDuty depending on the load current (the pulse width of the S-8338 Series is fixed to 88%), but its switching frequency does not change. Consequently, the ripple voltage generated from switching can be removed easily via a filter.

2. Soft-start function

For this IC, the built-in soft-start circuit controls the rush current and overshoot of the output voltage when powering on or when the ON/OFF pin is switched to the "H" level. A reference voltage adjustment method is adopted as the soft-start method. The following describes the soft-start function.

The raising of the output voltage is controlled by slowly raising the reference voltage of the error amplifier input from 0 V at power on as shown in **Figure 7**. The soft-start function is realized by controlling the voltage of the FB pin so that it is the same potential as the reference voltage that is slowly raised. A Rail-to-Rail amplifier is adopted as the error amplifier, which means that the voltage is loop controlled so that it can be the same as the reference voltage.

The following explains the operation at power on (refer to **Figure 8**).

When V_{IN} is raised from 0 V to 3.3 V, the V_{OUT} voltage rises to a value close to V_{IN} via the inductor L and diode SD. This raises the voltage of the FB pin (V_{FB}) by approximately 0.35 V (when $R_{FB1} = 8.2 \text{ k}\Omega$, $R_{FB2} = 1.0 \text{ k}\Omega$). Because the reference voltage rises from 0 V, the V_{FB} voltage is higher than the reference voltage while the voltage rises from 0 V to 0.35 V. During this period, the EXT output is low. The EXT output is in the stepped-up status between high and low after the reference voltage reaches 0.35 V and V_{OUT} is slowly raised in accordance with the rising of the reference voltage.

Once the reference voltage rises, the voltage cannot be reset (the reference voltage is 0 V) unless the power supply voltage is the UVLO detection voltage or lower or the shutdown pin is the "L" level. Conversely, when the power supply voltage rises up to the reset voltage after it is lowered to the UVLO detection voltage or lower, the output voltage is stepped up by the soft-start function.

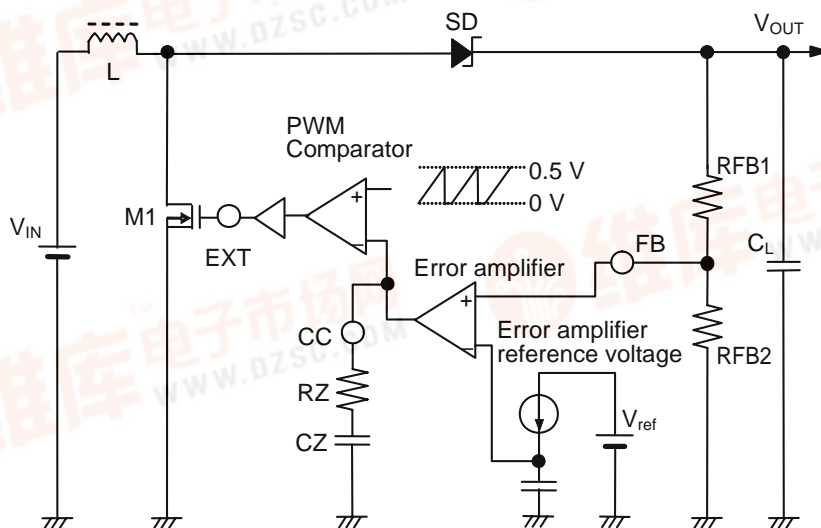

Figure 7

Seiko Instruments Inc.



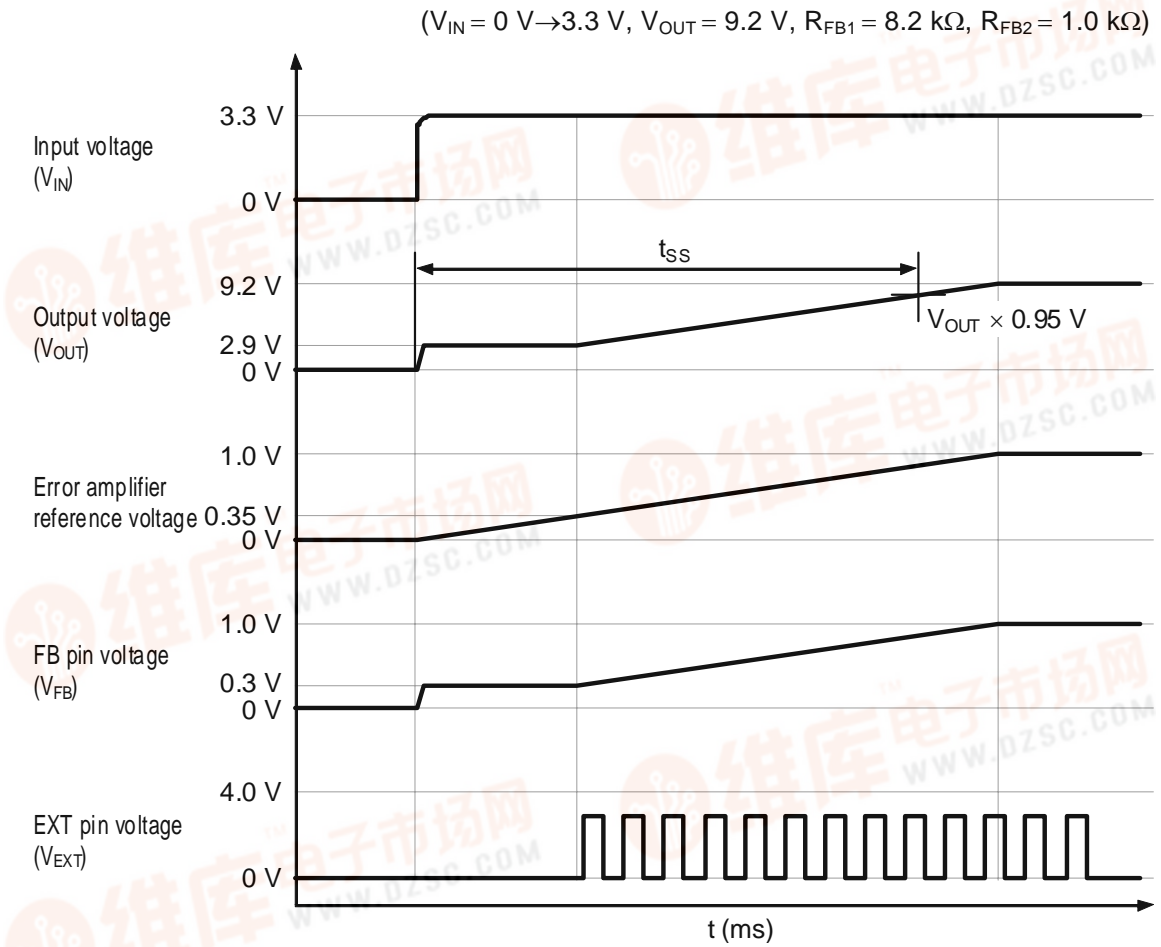

Figure 8



3. Shutdown pin (S-8338 Series only)

This pin stops or starts step-up operations.

Switching the shutdown pin to the “L” level stops operation of all the internal circuits and reduces the current consumption significantly.

DO NOT use the shutdown pin in a floating state because it is not pulled up or pulled down internally. DO NOT apply voltage of between 0.3 V and 1.8 V to the shutdown pin because applying such a voltage increases the current consumption. If the shutdown pin is not used, connect it to the VIN pin.

Table 7

Shutdown Pin	CR Oscillator	Output Voltage
“H”	Operates	Fixed
“L”	Stopped	$\cong V_{IN}^{*1}$

*1. Voltage of V_{IN} from which the voltage drop from the DC resistance of the inductor and the forward voltage of the diode are subtracted

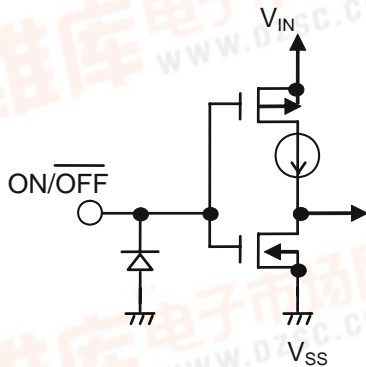

Figure 9

4. Timer latch short-circuit protection function

This IC has a timer latch short-circuit protection circuit that stops the switching operation when the output voltage drops for a specific time due to output short-circuiting. A capacitor (CSP) that is used to set the delay time of this short-circuit protection circuit is connected to the CSP pin.

This IC operates at the maximum duty ratio if the output voltage drops due to output short-circuiting. At the maximum duty ratio, constant-current charging of CSP starts. If this status lasts for a specific time and the CSP pin voltage rises above the reference voltage (1 V), the latch mode is set. Note that the latch mode is different from the shutdown status in that the switching operation is stopped but the internal circuitry operates normally.

To reset the latch operation to protect the IC from short-circuiting, either lower V_{IN} to the timer latch reset voltage or lower or lower the level of the shutdown pin to “L”. Note that the latch operation is not reset even if V_{IN} falls below the UVLO voltage.

5. UVLO function

This IC includes a UVLO (under-voltage lockout) circuit to prevent the IC from malfunctioning due to a transient status when power is applied or a momentary drop of the supply voltage. When UVLO is in the detection state, switching is stopped and the external FET is held in the off status. Once UVLO enters the detection state, the soft-start function is reset.

Note that the other internal circuits operate normally and that the status is different from the power-off status.

6. Error amplifier

The error amplifier outputs the PWM control signal so that the voltage of the FB pin is held at a specific value (1 V). By connecting a resistor (RZ) and capacitor (CZ) to the output pin (CC pin) of the error amplifier in series, an optional loop gain can be set, enabling stabilized phase compensation.

7. Operation

The following are basic equations [(1) through (7)] of the step-up switching regulator (refer to Figure 10).

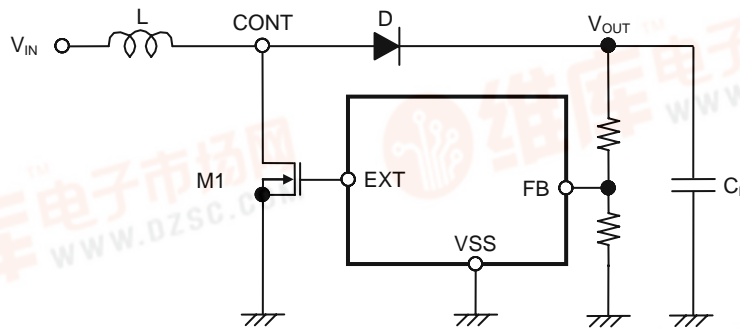

Figure 10 Step-up Switching Regulator Circuit for Basic Equations

Voltage at the CONT pin at the moment M1 is turned ON (current I_L flowing through L is zero), V_A :
 $V_A = V_S^{*1}$ (1)

*1. V_S : Non-saturated voltage of M1

Change in I_L over time:

$$\frac{dI_L}{dt} = \frac{V_L}{L} = \frac{V_{IN} - V_S}{L} \dots\dots\dots(2)$$

Integration of the above equation:

$$I_L = \left(\frac{V_{IN} - V_S}{L} \right) \cdot t \dots\dots\dots(3)$$

I_L flows while M1 is ON (t_{ON}). This time is determined by the oscillation frequency of OSC.

Peak current (I_{PK}) after t_{ON} :

$$I_{PK} = \left(\frac{V_{IN} - V_S}{L} \right) \cdot t_{ON} \dots\dots\dots(4)$$

The energy stored in L is represented by $\frac{1}{2} \cdot L(I_{PK})^2$.

When M1 is turned OFF (t_{OFF}), the energy stored in L is released via a diode, generating a reverse voltage (V_L).

V_L :

$$V_L = (V_{OUT} + V_D^{*2}) - V_{IN} \dots\dots\dots(5)$$

*2. V_D : Diode forward voltage

The voltage on the CONT pin rises only by $V_{OUT} + V_D$.



Change in current (I_L) flowing through the diode into V_{OUT} during t_{OFF} :

$$\frac{dI_L}{dt} = \frac{V_L}{L} = \frac{V_{OUT} + V_D - V_{IN}}{L} \dots\dots\dots(6)$$

Integration of the above equation is as follows:

$$I_L = I_{PK} - \left(\frac{V_{OUT} + V_D - V_{IN}}{L} \right) \cdot t \dots\dots\dots(7)$$

During t_{ON} , energy is stored in L and is not transmitted to V_{OUT} . When receiving output current (I_{OUT}) from V_{OUT} , the energy of the capacitor (C_L) is used. As a result, the pin voltage of C_L is reduced, and goes to the lowest level after $M1$ is turned ON (t_{ON}). When $M1$ is turned OFF, the energy stored in L is transmitted via the diode to C_L , and the pin voltage of C_L rises drastically. Because V_{OUT} is a time function indicating the maximum value (ripple voltage: V_{p-p}) when the current flowing through the diode into V_{OUT} and the load current I_{OUT} match.

Next, this ripple voltage is determined as follows.

I_{OUT} vs t_1 (time) from when $M1$ is turned OFF (after t_{ON}) to when V_{OUT} reaches the maximum level:

$$I_{OUT} = I_{PK} - \left(\frac{V_{OUT} + V_D - V_{IN}}{L} \right) \cdot t_1 \dots\dots\dots(8)$$

$$\therefore t_1 = (I_{PK} - I_{OUT}) \cdot \left(\frac{L}{V_{OUT} + V_D - V_{IN}} \right) \dots\dots\dots(9)$$

When $M1$ is turned ON (after t_{OFF}), $I_L = 0$ (when the energy of the inductor is completely transmitted):
 Based on equation (7),

$$\left(\frac{L}{V_{OUT} + V_D - V_{IN}} \right) = \frac{t_{OFF}}{I_{PK}} \dots\dots\dots(10)$$

When substituting equation (10) for equation (9):

$$t_1 = t_{OFF} - \left(\frac{I_{OUT}}{I_{PK}} \right) \cdot t_{OFF} \dots\dots\dots(11)$$

Electrical charge ΔQ_1 which is charged in C_L during t_1 :

$$\Delta Q_1 = \int_0^{t_1} I_L dt = I_{PK} \cdot \int_0^{t_1} dt - \frac{V_{OUT} + V_D - V_{IN}}{L} \cdot \int_0^{t_1} t dt = I_{PK} \cdot t_1 - \frac{V_{OUT} + V_D - V_{IN}}{L} \cdot \frac{1}{2} t_1^2 \dots\dots\dots(12)$$

When substituting equation (12) for equation (9):

$$\Delta Q_1 = I_{PK} - \frac{1}{2} (I_{PK} - I_{OUT}) \cdot t_1 = \frac{I_{PK} + I_{OUT}}{2} \cdot t_1 \dots\dots\dots(13)$$

A rise voltage (V_{p-p}) due to ΔQ_1 :

$$V_{p-p} = \frac{\Delta Q_1}{C_L} = \frac{1}{C_L} \cdot \left(\frac{I_{PK} + I_{OUT}}{2} \right) \cdot t_1 \dots\dots\dots(14)$$

When taking into consideration I_{OUT} consumed during t_1 and ESR^{*1} (R_{ESR}) of C_L :

$$V_{p-p} = \frac{\Delta Q_1}{C_L} = \frac{1}{C_L} \cdot \left(\frac{I_{PK} + I_{OUT}}{2} \right) \cdot t_1 + \left(\frac{I_{PK} + I_{OUT}}{2} \right) \cdot R_{ESR} - \frac{I_{OUT} \cdot t_1}{C_L} \dots\dots\dots(15)$$

*1. Equivalent Series Resistance



When substituting equation (11) for equation (15):

$$V_{p-p} = \frac{(I_{PK} - I_{OUT})^2}{2I_{PK}} \cdot \frac{t_{OFF}}{C_L} + \left(\frac{I_{PK} + I_{OUT}}{2} \right) \cdot R_{ESR} \dots\dots\dots(16)$$

Therefore to reduce the ripple voltage, it is important that the capacitor connected to the output pin has a large capacity and a small ESR.



External Parts Selection

1. Inductor

The inductance has a strong influence on the maximum output current (I_{OUT}) and efficiency (η). The peak current (I_{PK}) increases by decreasing L and the stability of the circuit improves and I_{OUT} increases. If L is decreased further, the efficiency falls, and I_{OUT} decreases if the current drive capability of the external transistor is insufficient.

The loss of I_{PK} by the switching transistor decreases by increasing L and the efficiency becomes maximum at a certain L value. Further increasing L decrease the efficiency due to the loss of the DC resistance of the inductor. I_{OUT} also decreases.

If the oscillation frequency is higher, a smaller L value can be chosen, making the inductor smaller. In the S-8337/8338 Series, the oscillation frequency can be varied within the range of 286 kHz to 1.133 MHz by the external resistor, so select an L value best suited to the frequency. The recommended value is between 2.2 μ H and 22 μ H.

When selecting an inductor, note the allowable current of the inductor. If a current exceeding this allowable current flows through the inductor, magnetic saturation occurs, substantially lowering the efficiency and increasing the current, which results in damage to the IC.

Therefore, select an inductor so that I_{PK} does not exceed the allowable current. I_{PK} is expressed by the following equations in the discontinuous mode and continuous mode.

$$I_{PK} = \sqrt{\frac{2 I_{OUT}(V_{OUT} + V_D - V_{IN})}{f_{OSC} \cdot L}} \quad (\text{discontinuous mode}) \quad \dots\dots\dots(17)$$

$$I_{PK} = \frac{V_{OUT} + V_D}{V_{IN}} \cdot I_{OUT} + \frac{(V_{OUT} + V_D - V_{IN}) \cdot V_{IN}}{2 \cdot (V_{OUT} + V_D) \cdot f_{OSC} \cdot L} \quad (\text{continuous mode}) \quad \dots\dots\dots(18)$$

f_{OSC} = Oscillation frequency, $V_D \cong 0.4$ V.

2. Diode

Use an external diode that meets the following requirements.

- Low forward voltage
- High switching speed
- Reverse breakdown voltage: $V_{OUT} + [\text{Spike voltage}]$ or more
- Rated current: I_{PK} or more

3. Capacitors (C_{IN} , C_L)

The capacitor on the input side (C_{IN}) can lower the supply impedance and level the input current for better efficiency. Select C_{IN} according to the impedance of the power supply to be used.

The capacitor on the output side (C_L) is used to smooth the output voltage. Select an appropriate capacitance value based on the I/O conditions and load conditions. A capacitance of 10 μ F or more is recommended.

By adjusting the phase compensation of the feedback loop using the external resistor (RZ) and capacitor (CZ), a ceramic capacitor can be used as the capacitor on the output side. If a capacitor whose equivalent series resistance is between 30 m Ω and 500 m Ω is used as the output capacitor, the adjustable range of the phase compensation is wider; however, note that other characteristics may be affected by ripple voltage or other conditions at this time. The optimal capacitor differs depending on the L value, capacitance value, wiring, and application (output load), so select the capacitor after performing sufficient evaluation under the actual usage conditions.



4. External transistor

A bipolar (NPN) or enhancement (N-channel) MOS FET transistor can be used as the external capacitor.

4.1 Bipolar (NPN) type

The driving capability when the output current is increased by using a bipolar transistor is determined by h_{FE} and R_b of the bipolar transistor. **Figure 11** shows a peripheral circuit.

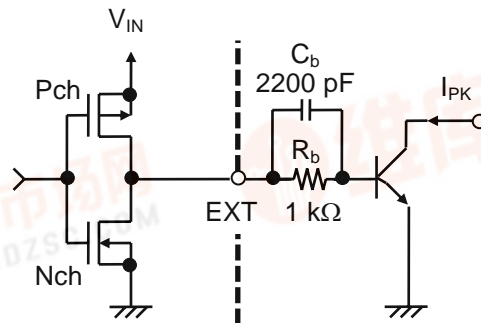

Figure 11 External Transistor Periphery

1 kΩ is recommended for R_b . Actually, calculate the necessary base current (I_b) from h_{FE} of the bipolar transistor as follows and select an R_b value lower than this.

$$I_b = \frac{I_{PK}}{h_{FE}}$$

$$R_b = \frac{V_{IN} - 0.7}{I_b} - \frac{0.4}{|I_{EXT}|}$$

A small R_b increases the output current, but the efficiency decreases. Actually, a pulsating current flows and a voltage drop occurs due to the wiring capacitance. Determine the optimum value by experiment.

A speed-up capacitor (C_b) connected in parallel with R_b resistance as shown in **Figure 11** decreases the switching loss and improves the efficiency.

Select C_b by observing the following equation.

$$C_b \leq \frac{1}{2\pi \cdot R_b \cdot f_{OSC} \cdot 0.7}$$

However, in practice, the optimum C_b value also varies depending on the characteristics of the bipolar transistor employed. Therefore, determine the optimum value of C_b by experiment.

4. 2 Enhancement MOS FET type

Use an Nch power MOS FET. For high efficiency, using a MOS FET with a low ON resistance (R_{ON}) and small input capacitance (C_{ISS}) is ideal, however, ON resistance and input capacitance generally share a trade-off relationship. The ON resistance is efficient in a range in which the output current is relatively great during low-frequency switching, and the input capacitance is efficient in a range in which the output current is middling during high-frequency switching. Select a MOS FET whose ON resistance and input capacitance are optimal depending on the usage conditions.

The input voltage (V_{IN}) is supplied for the gate voltage of the MOS FET, so select a MOS FET with a gate withstanding voltage that is equal to the maximum usage value of the input voltage or higher and a drain withstanding voltage that is equal to the amount of the output voltage (V_{OUT}) and diode voltage (V_D) or higher.

If a MOS FET with a threshold that is near the UVLO detection voltage is used, a large current may flow, stopping the output voltage from rising and possibly generating heat in the worst case. Select a MOS FET with a threshold that is sufficiently lower than the UVLO detection voltage value.

5. Oscillation frequency and maximum duty ratio setting resistors (ROSC, RDuty)

With the S-8337/8338 Series, the oscillation frequency can be set in a range of 286 kHz to 1.133 MHz using external resistance. Connect a resistor across the ROSC and VSS pins. Select the resistor by using the following equation and referring to **Figure 12**. However, the following equation and figure assume that the resistance value is the desired value and show the theoretical values when the IC is in the typical conditions. Note that fluctuations of resistance and IC are not considered.

$$R_{osc} [k\Omega] \cong \frac{140 \cdot 10^3}{f_{osc} [kHz]}$$

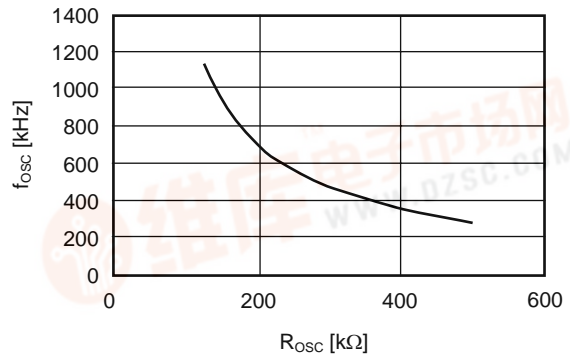

Figure 12 R_{osc} vs. f_{osc}

With the S-8337 Series, the maximum duty ratio can be set in a range of 47% to 88.5% by an external resistor. Connect the resistor across the RDuty and VSS pins. Select the resistance by using the following equation and referring to **Figure 13**. The maximum duty ratio fluctuates according to the oscillation frequency. If the value of ROSC is changed, therefore, be sure to change the value of RDuty so that it is always in proportion to ROSC. However, the following equation and figure assume that the resistance value is the desired value and show the theoretical values when the IC is in the typical conditions. Note that fluctuations of resistance and IC are not considered.

$$\frac{R_{Duty}}{R_{osc}} \cong \frac{(94.5 - \text{MaxDuty})}{11.5}$$

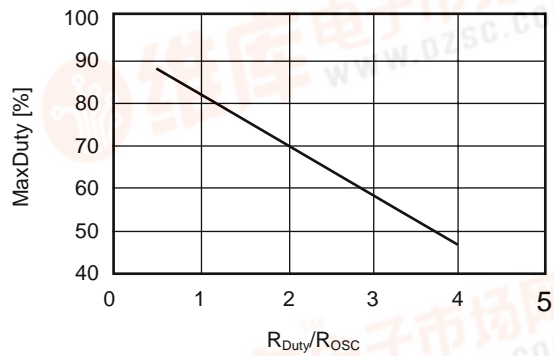

Figure 13 R_{Duty}/R_{osc} vs. MaxDuty

Connect resistors ROSC and RDuty as close to the IC as possible.



6. Short-circuit protection delay time setting capacitor (CSP)

With the S-8337/8338 Series, the short-circuit protection delay time can be set to any value by an external capacitor. Connect the capacitor across the CSP and VSS pins. Select the capacitance by using the following equation and referring to **Figure 14**. However, the following equation and figure assume that the capacitor value is the desired value and show the theoretical values when the IC is in the typical conditions. Note that fluctuations of capacitor and IC are not considered.

$$C_{SP} [\mu\text{F}] \cong \frac{t_{PRO} [\text{ms}] \cdot 2 \cdot 10^{-3}}{1.0}$$

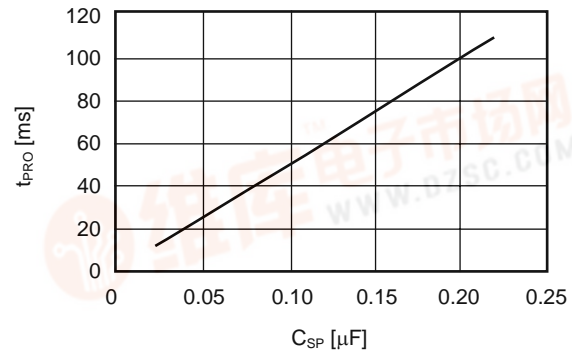

Figure 14 C_{SP} vs. t_{PRO}

7. Output voltage setting resistors (RFB1, RFB2)

With the S-8337/8338 Series, the output voltage can be set to any value by external divider resistors. Connect the divider resistors across the V_{OUT} and VSS pins. Because V_{FB} = 1 V, the output voltage can be calculated by this equation.

$$V_{OUT} = \frac{(R_{FB1} + R_{FB2})}{R_{FB2}}$$

Connect divider resistors RFB1 and RFB2 as close to the IC to minimize effects from of noise. If noise does have an effect, adjust the values of RFB1 and RFB2 so that R_{FB1} + R_{FB2} < 100 kΩ.

CFB connected in parallel with RFB1 is a capacitor for phase compensation. Select the optimum value of this capacitor at which the stable operation can be ensured from the values of the inductor and output capacitor.

8. Phase compensation setting resistor and capacitor (RZ, CZ)

The S-8337/8338 Series needs appropriate compensation for the voltage feedback loop to prevent excessive output ripple and unstable operation from deteriorating the efficiency. This compensation is implemented by connecting RZ and CZ in series across the CC and VSS pins. RZ sets the high-frequency gain for a high-speed transient response. CZ sets the pole and zero of the error amplifier and keeps the loop stable. Adjust RZ and CZ, taking into consideration conditions such as the inductor, output capacitor, and load current, so that the optimum transient characteristics can be obtained.

■ Standard Circuits

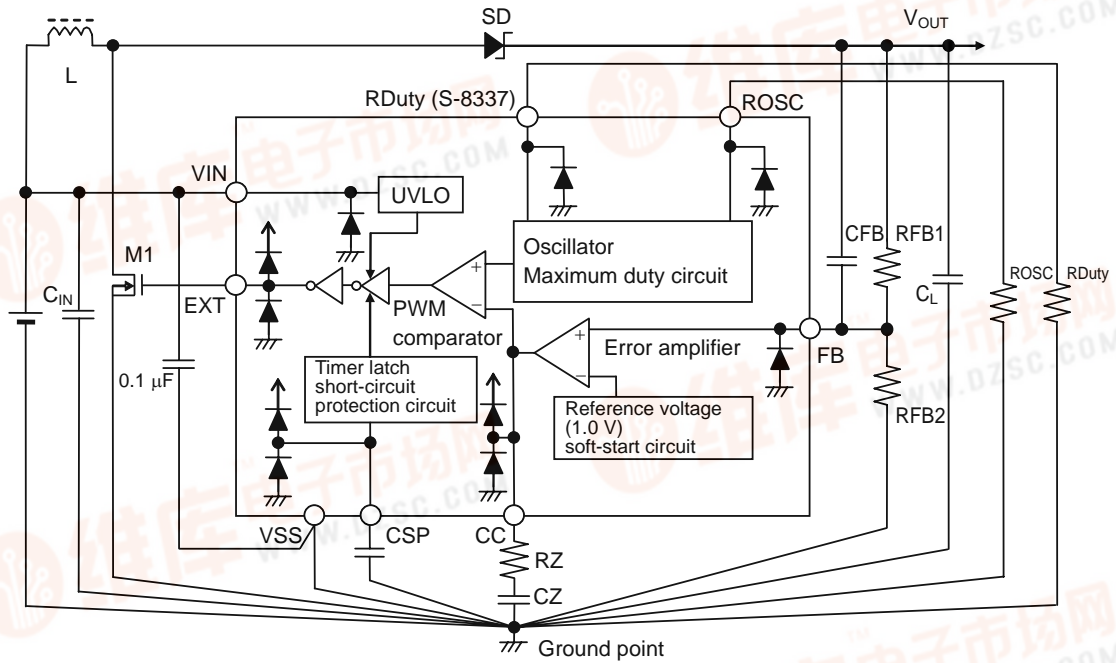

Figure 15 Standard Circuit (S-8337 Series)

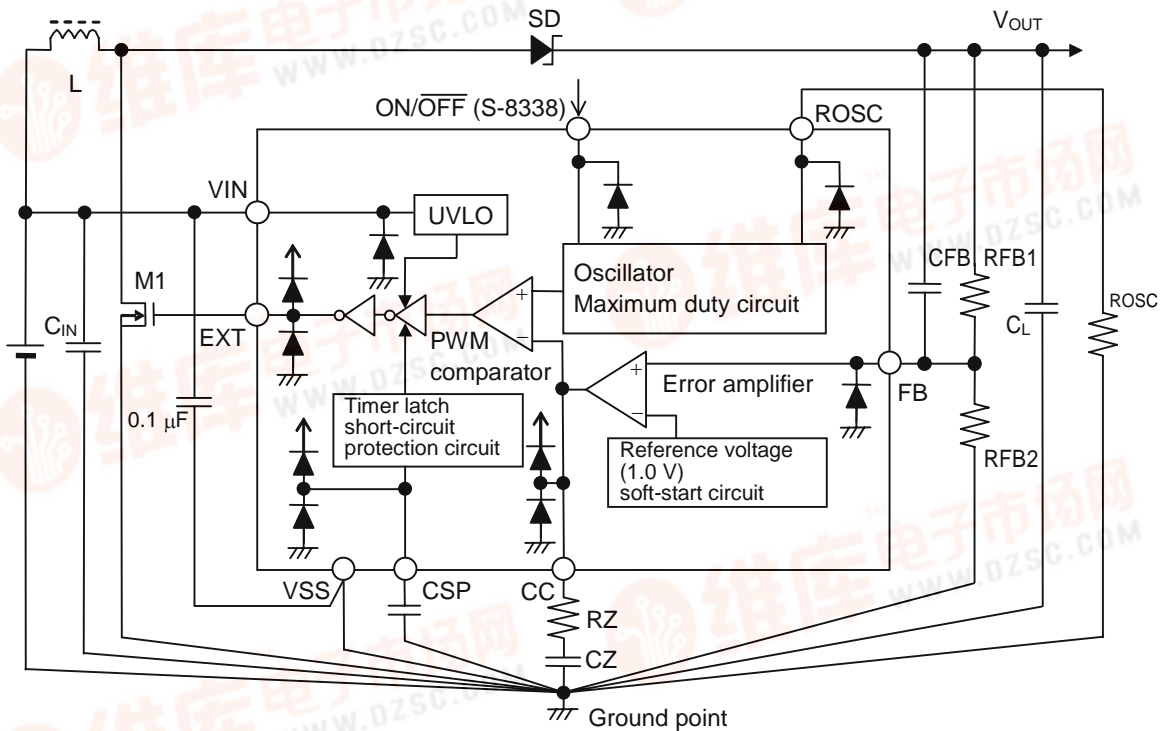

Figure 16 Standard Circuit (S-8338 Series)

Caution The above connection diagram and constant will not guarantee successful operation. Perform thorough evaluation using the actual application to set the constant.



■ Precaution

- Mount external capacitors, diodes, and inductor as close as possible to the IC.
- Characteristics ripple voltage and spike noise occur in IC containing switching regulators. Moreover rush current flows at the time of a power supply injection. Because these largely depend on the inductor, the capacitor and impedance of power supply used, fully check them using an actually mounted model.
- Make sure the dissipation of the switching transistor (especially at a high temperature) does not exceed the allowable power dissipation of the package.
- The performance of a switching regulator varies depending on the design of the PCB patterns, peripheral circuits, and external parts. Thoroughly test all settings with your device.
- This IC builds in soft start function, starts reference voltage gradually, and it is controlled so that FB pin voltage and reference voltage become this potential. Therefore, keep in mind that it will be in a maximum duty state according to the factor of IC exterior if FB pin voltage is held less than reference voltage.
- Although the IC contains a static electricity protection circuit, static electricity or voltage that exceeds the limit of the protection circuit should not be applied.
- Seiko Instruments Inc. assumes no responsibility for the way in which this IC is used on products created using this IC or for the specifications of that product, nor does Seiko Instruments Inc. assume any responsibility for any infringement of patents or copyrights by products that include this IC either in Japan or in other countries.

■ Characteristics (Typical Data)

1. Example of Major Temperature Characteristics (Ta = -40 to 85°C)

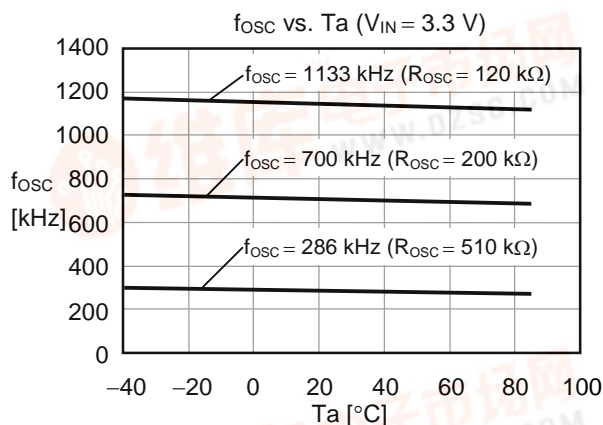
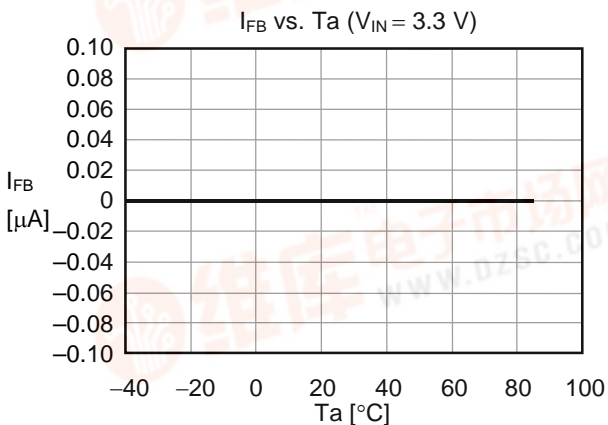
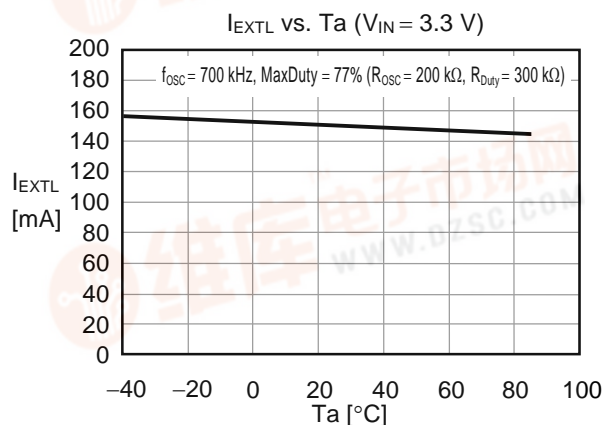
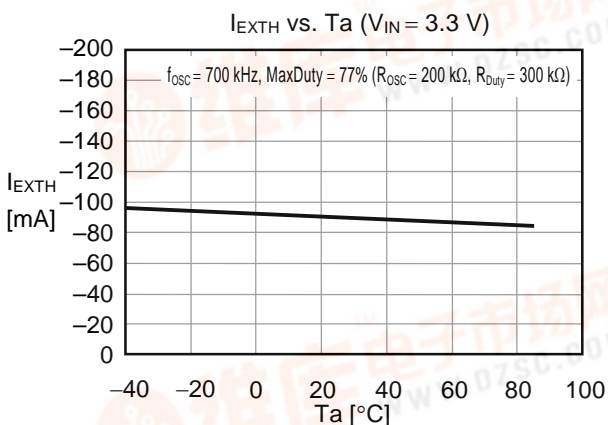
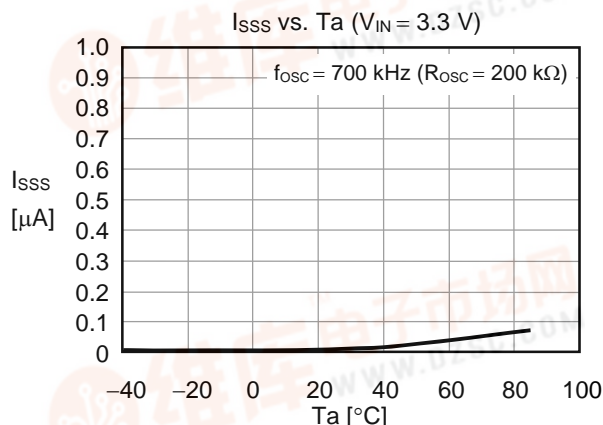
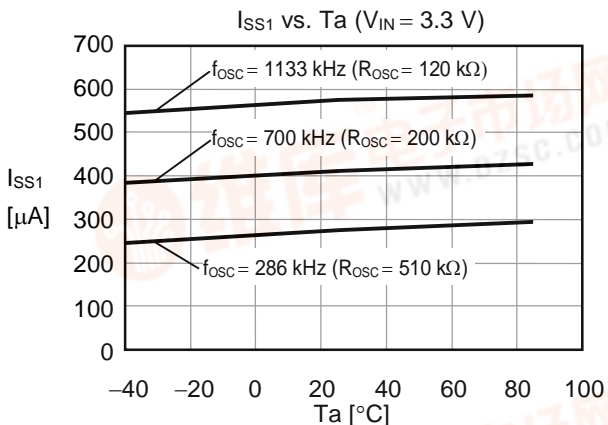

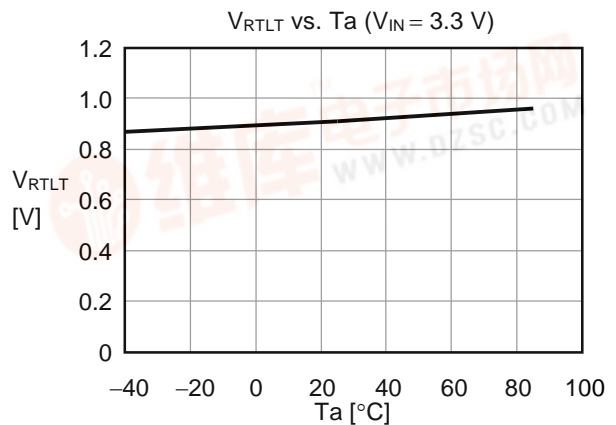
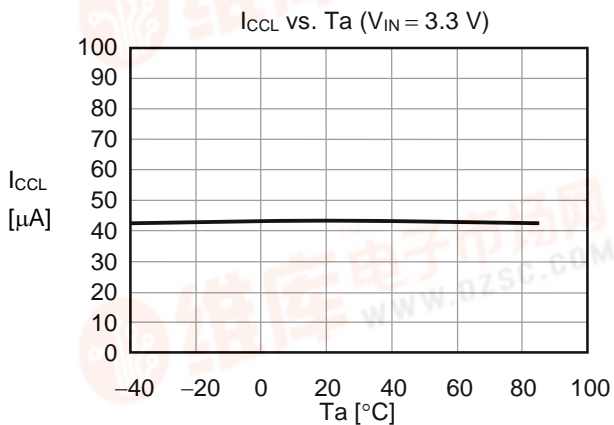
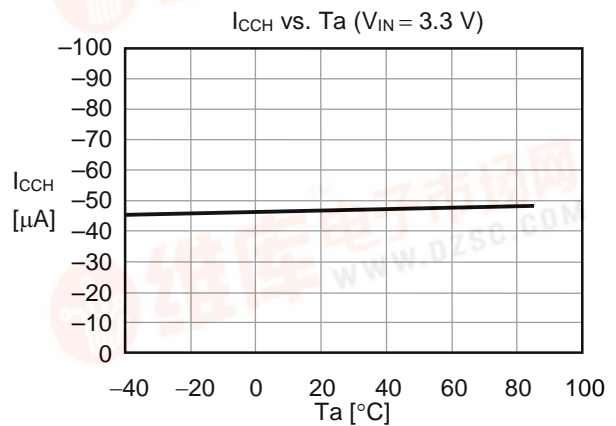
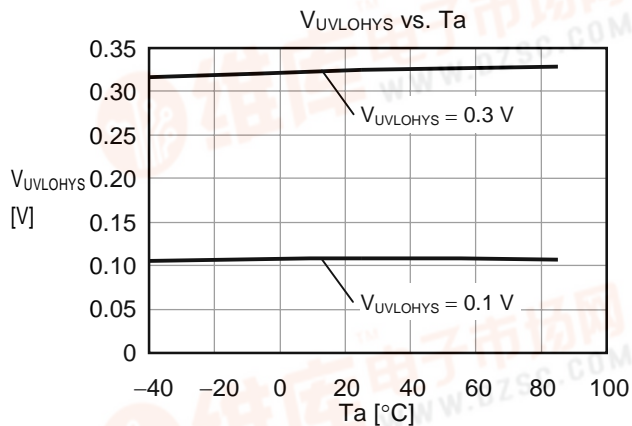
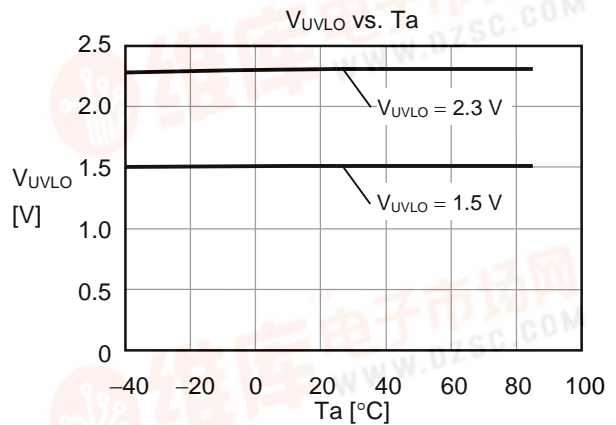
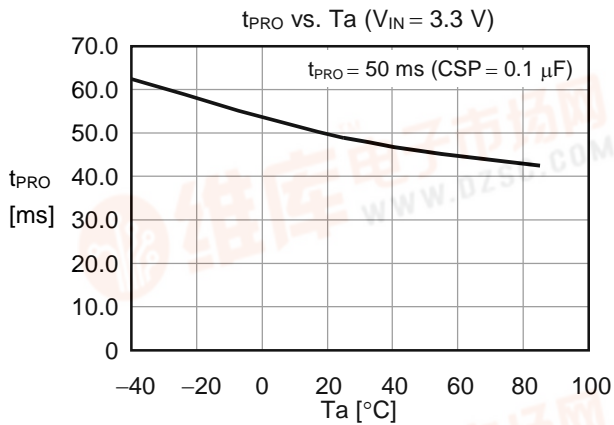
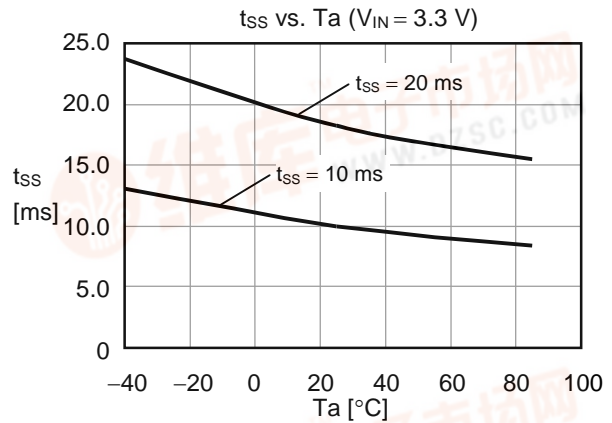
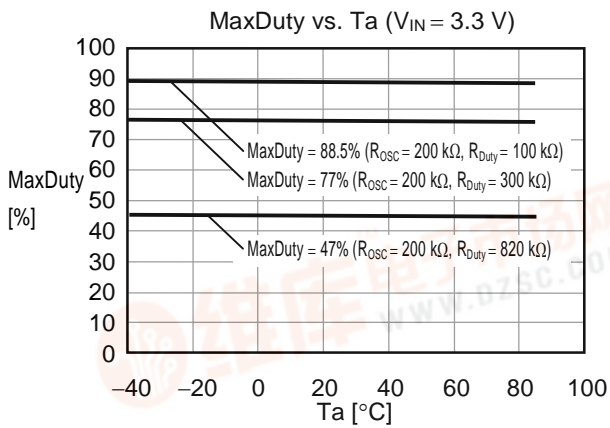

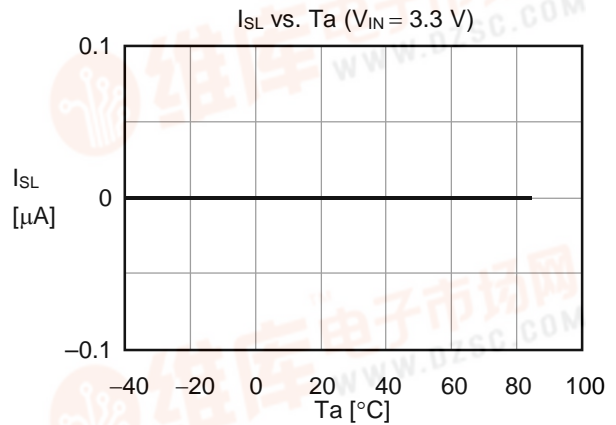
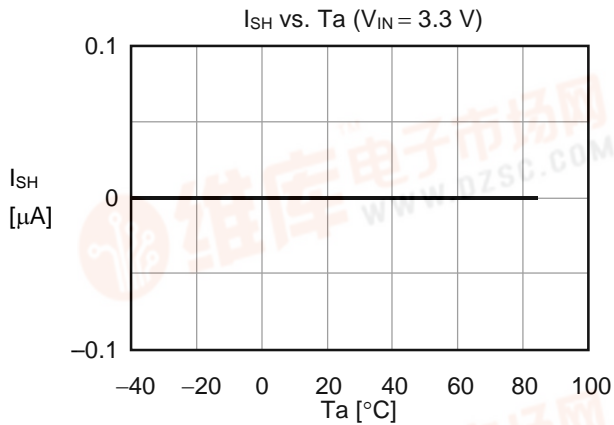
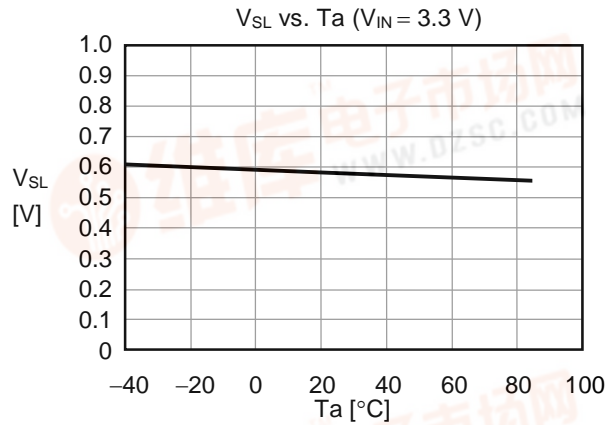
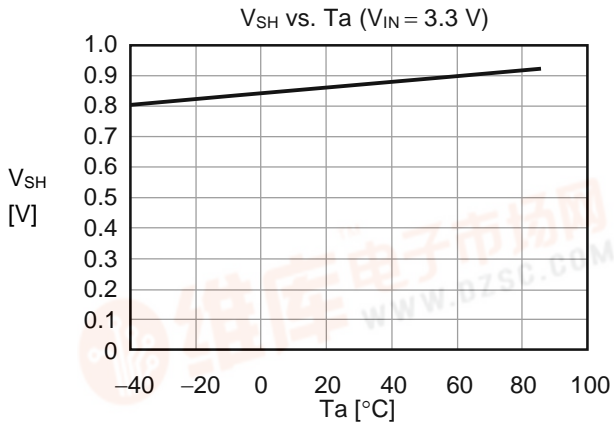

2. Example of Major Power Supply Dependence Characteristics (Ta = 25°C)

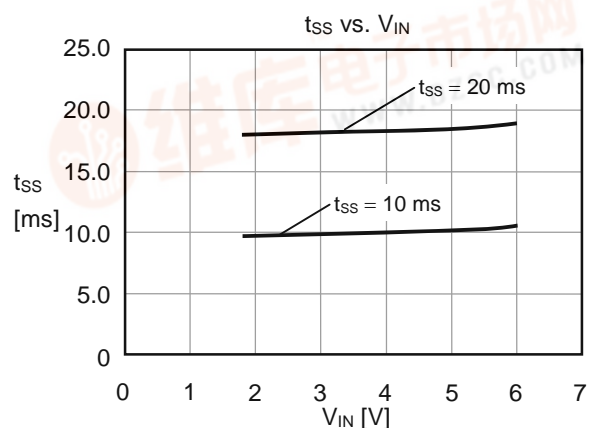
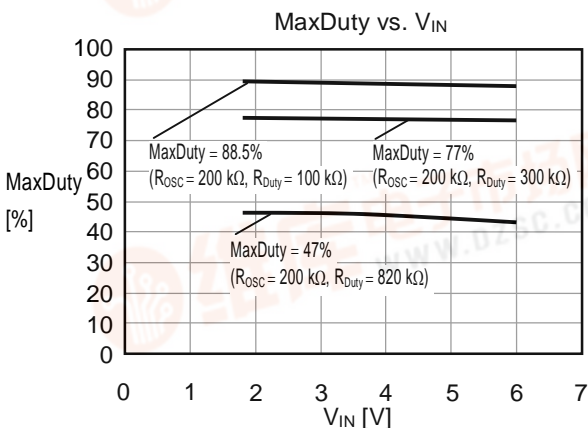
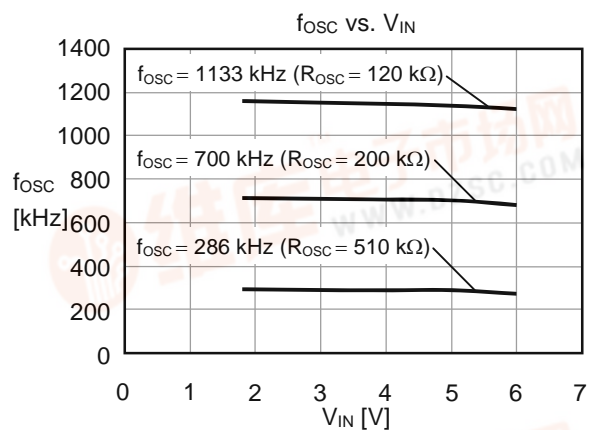
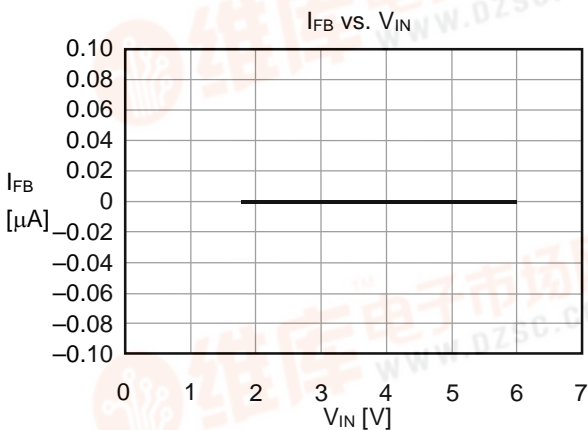
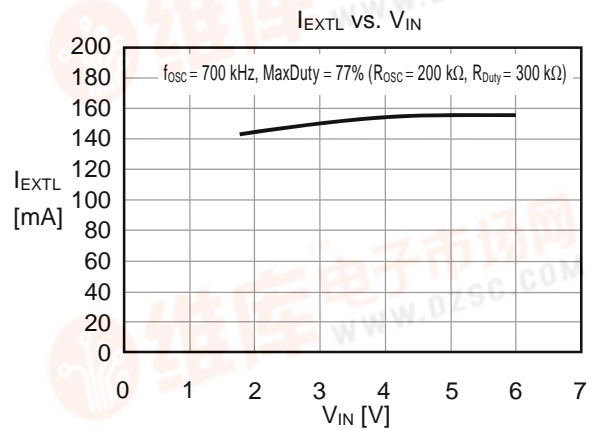
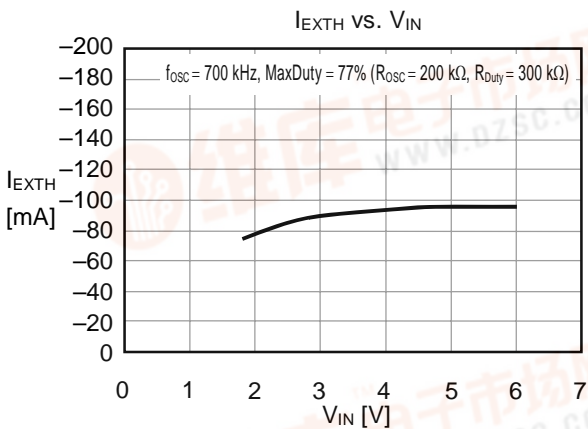
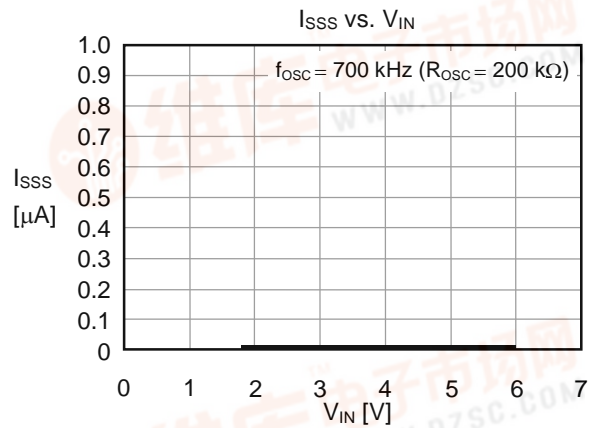
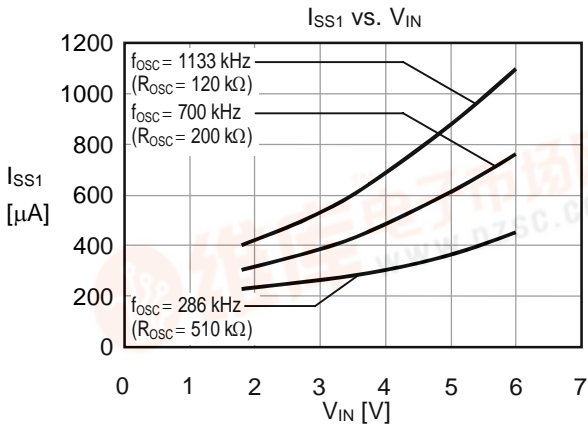

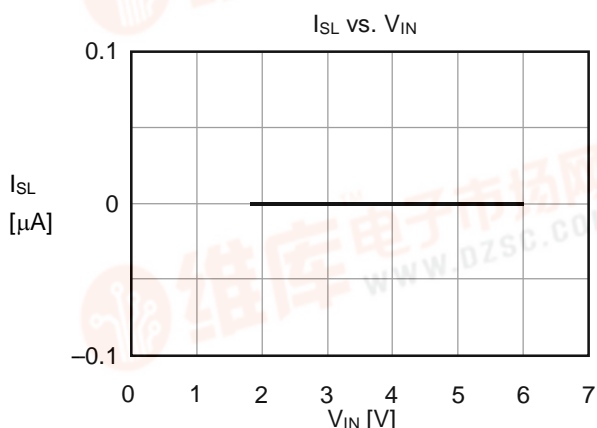
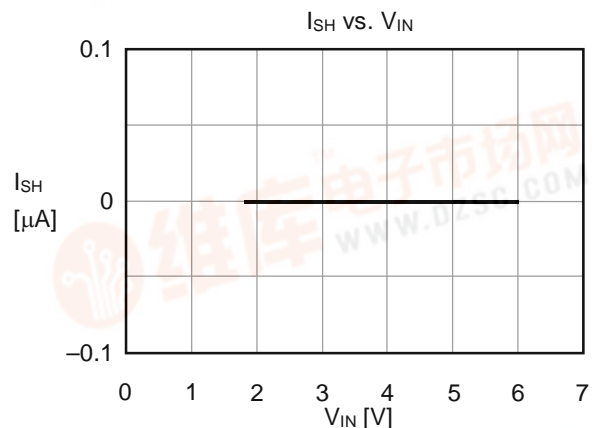
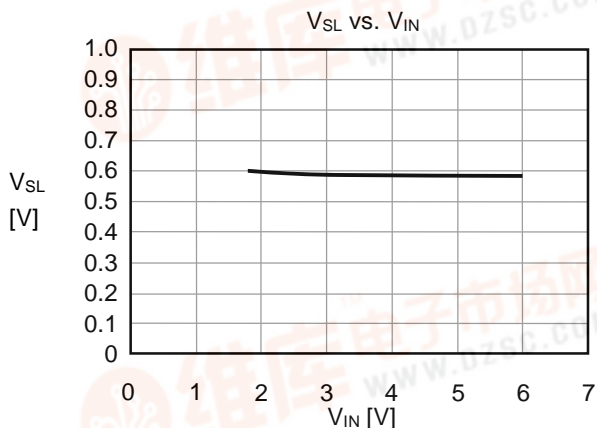
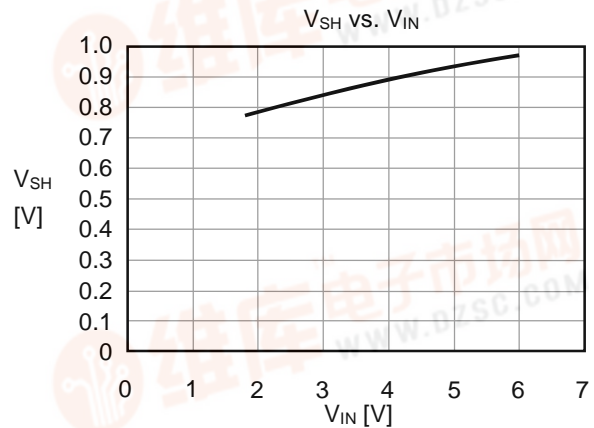
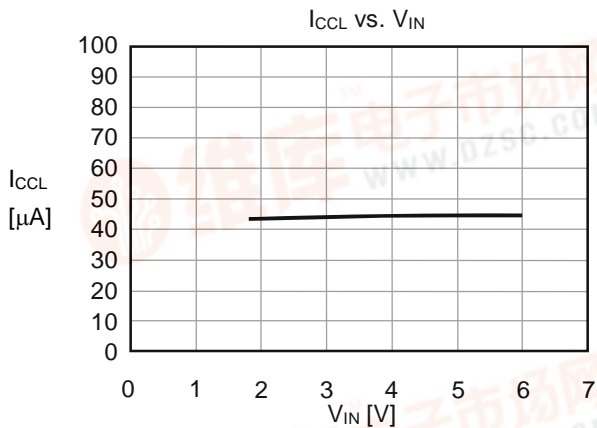
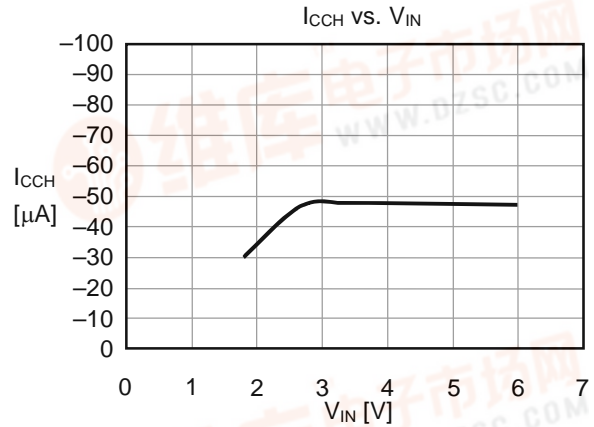
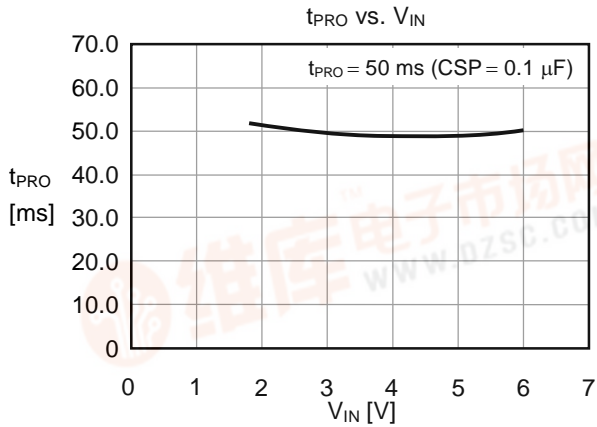

3. Example of External Parts Dependence Characteristics

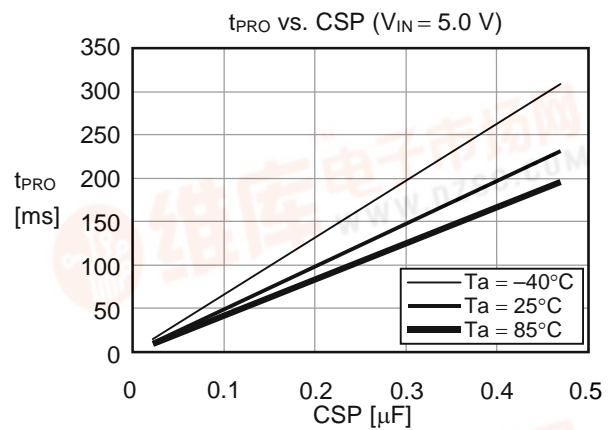
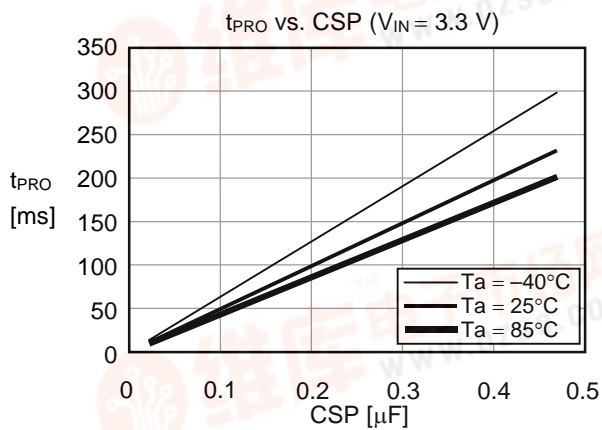
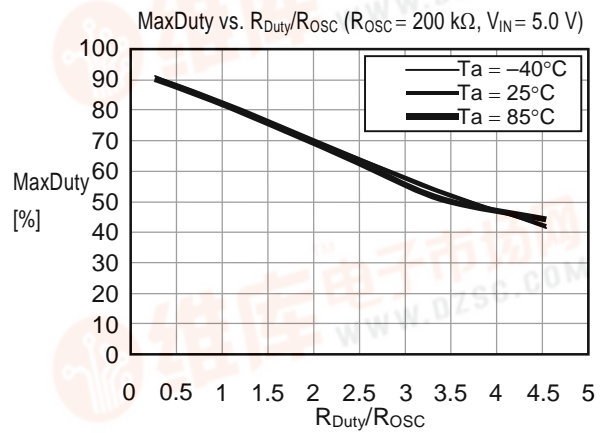
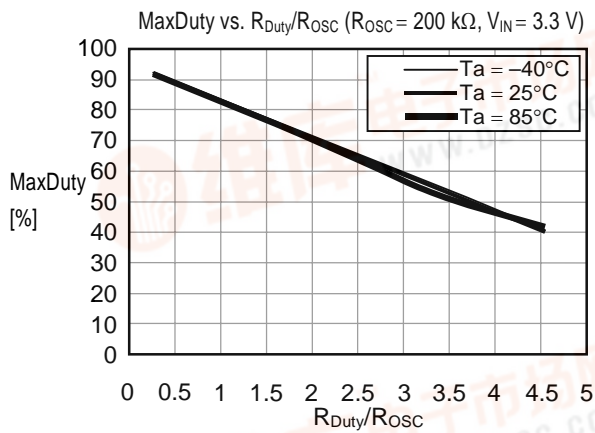
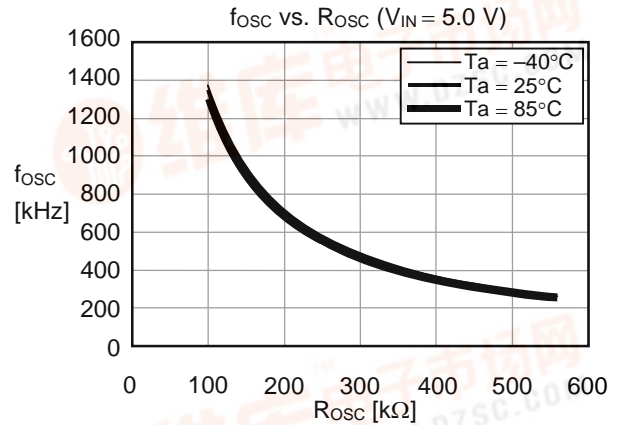
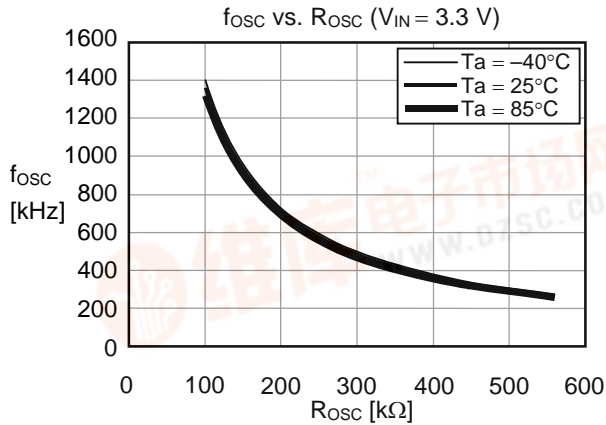

4. Examples of Transient Response Characteristics

4.1 Powering ON ($V_{OUT} = 9.2\text{ V}$, $V_{IN} = 0\text{ V} \rightarrow 3.3\text{ V}$, $T_a = 25^\circ\text{C}$)

(1) $f_{osc} = 1133\text{ kHz}$, $I_{OUT} = 0\text{ mA}$, $t_{SS} = 10\text{ ms}$

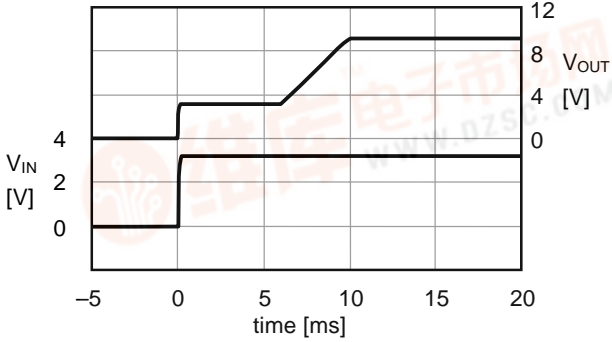

(2) $f_{osc} = 1133\text{ kHz}$, $I_{OUT} = 100\text{ mA}$, $t_{SS} = 10\text{ ms}$

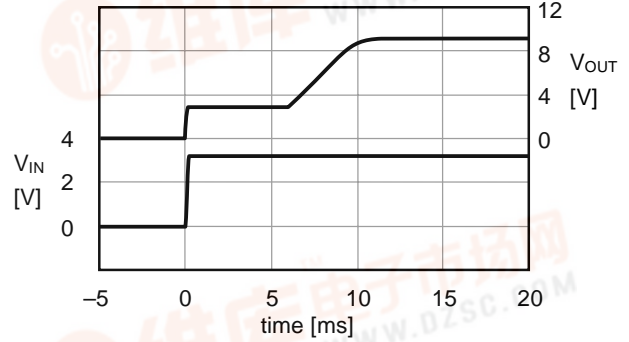

(3) $f_{osc} = 700\text{ kHz}$, $I_{OUT} = 0\text{ mA}$, $t_{SS} = 10\text{ ms}$

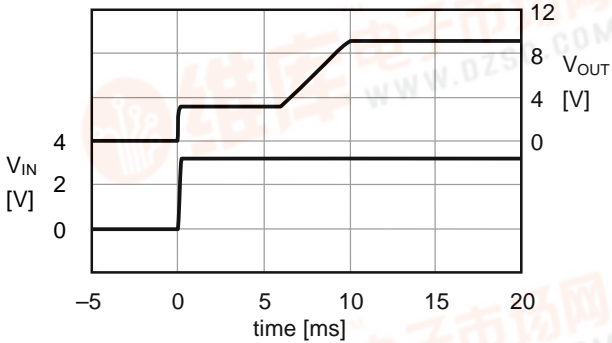

(4) $f_{osc} = 700\text{ kHz}$, $I_{OUT} = 100\text{ mA}$, $t_{SS} = 10\text{ ms}$

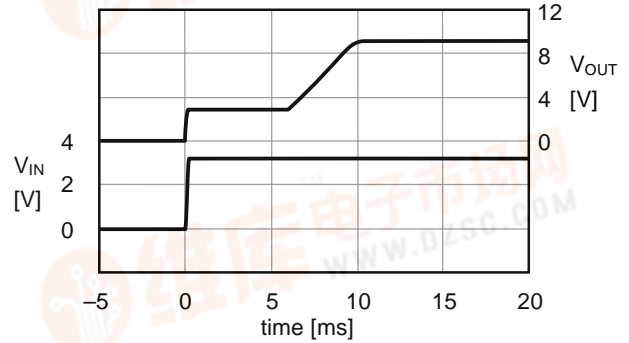

(5) $f_{osc} = 286\text{ kHz}$, $I_{OUT} = 0\text{ mA}$, $t_{SS} = 10\text{ ms}$

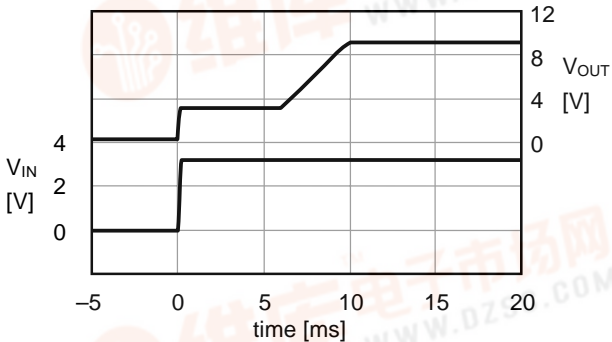

(6) $f_{osc} = 286\text{ kHz}$, $I_{OUT} = 100\text{ mA}$, $t_{SS} = 10\text{ ms}$

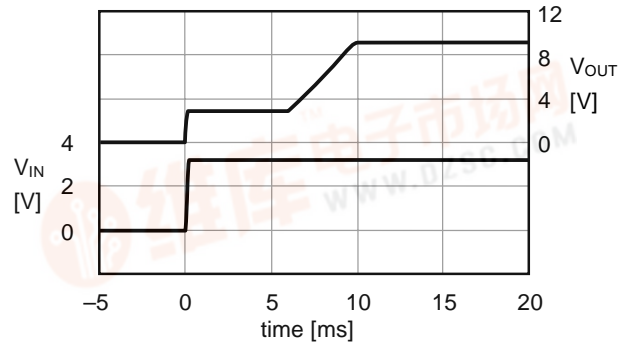

4.2 Responses of shutdown pin ($V_{OUT} = 9.2\text{ V}$, $V_{ON/OFF} = 0\text{ V} \rightarrow 3.3\text{ V}$)

(1) $f_{OSC} = 1133\text{ kHz}$, $I_{OUT} = 0\text{ mA}$, $t_{SS} = 10\text{ ms}$

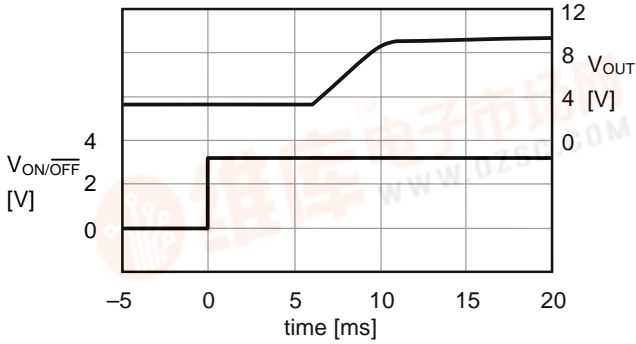

(2) $f_{OSC} = 1133\text{ kHz}$, $I_{OUT} = 100\text{ mA}$, $t_{SS} = 10\text{ ms}$

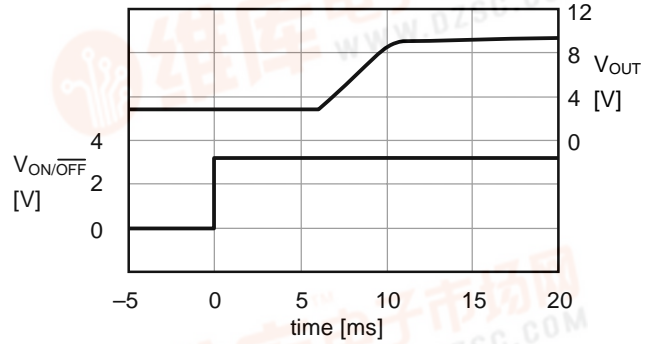

(3) $f_{OSC} = 700\text{ kHz}$, $I_{OUT} = 0\text{ mA}$, $t_{SS} = 10\text{ ms}$

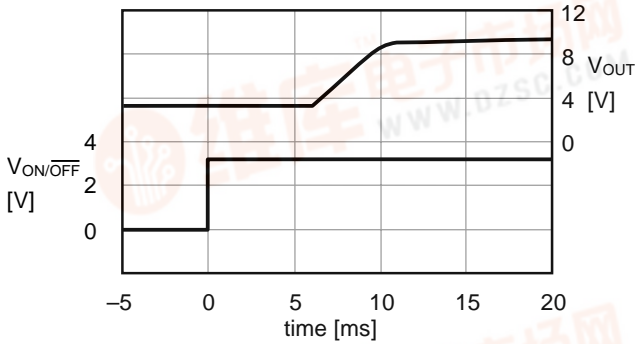

(4) $f_{OSC} = 700\text{ kHz}$, $I_{OUT} = 100\text{ mA}$, $t_{SS} = 10\text{ ms}$

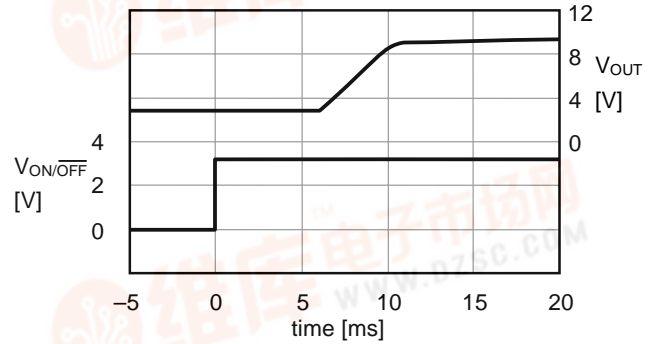

(5) $f_{OSC} = 286\text{ kHz}$, $I_{OUT} = 0\text{ mA}$, $t_{SS} = 10\text{ ms}$

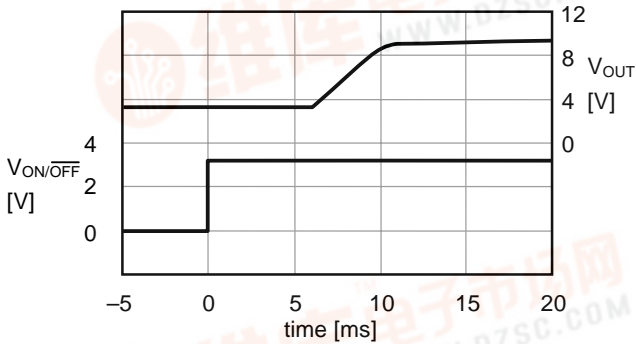

(6) $f_{OSC} = 286\text{ kHz}$, $I_{OUT} = 100\text{ mA}$, $t_{SS} = 10\text{ ms}$

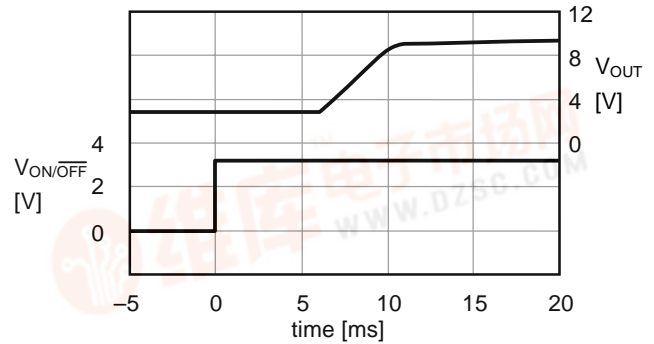

4.3 Load fluctuations ($V_{OUT} = 9.2\text{ V}$, $V_{IN} = 3.3\text{ V}$, $T_a = 25^\circ\text{C}$, $R_Z = 200\text{ k}\Omega$, $C_Z = 0.01\text{ }\mu\text{F}$)

(1) $f_{OSC} = 1133\text{ kHz}$, $I_{OUT} = 0.1\text{ mA} \rightarrow 100\text{ mA}$

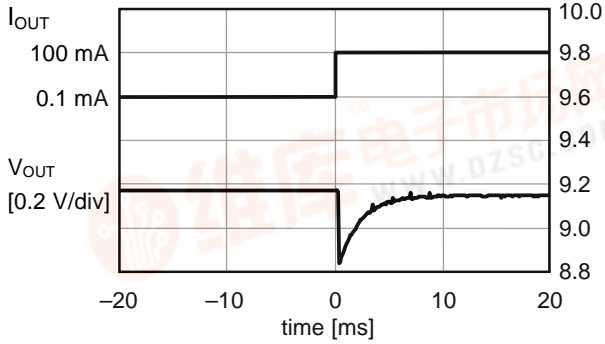

(2) $f_{OSC} = 1133\text{ kHz}$, $I_{OUT} = 100\text{ mA} \rightarrow 0.1\text{ mA}$

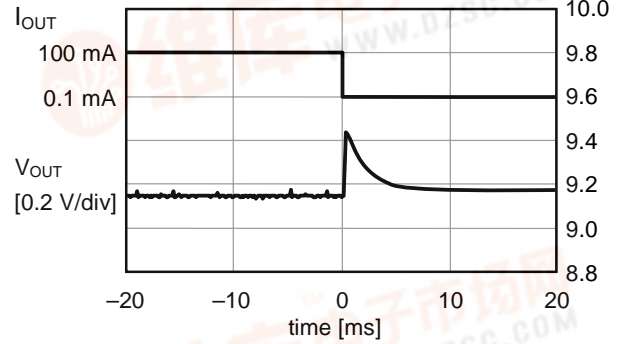

(3) $f_{OSC} = 700\text{ kHz}$, $I_{OUT} = 0.1\text{ mA} \rightarrow 100\text{ mA}$

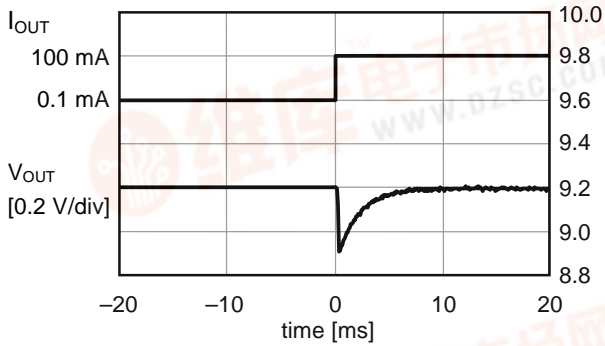

(4) $f_{OSC} = 700\text{ kHz}$, $I_{OUT} = 100\text{ mA} \rightarrow 0.1\text{ mA}$

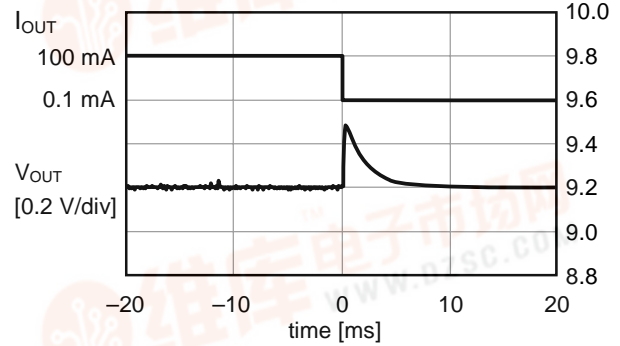

(5) $f_{OSC} = 286\text{ kHz}$, $I_{OUT} = 0.1\text{ mA} \rightarrow 100\text{ mA}$

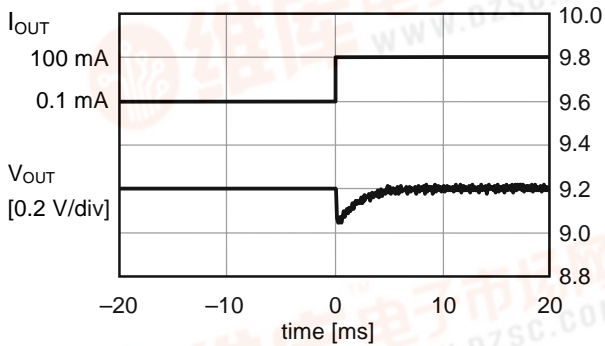

(6) $f_{OSC} = 286\text{ kHz}$, $I_{OUT} = 100\text{ mA} \rightarrow 0.1\text{ mA}$

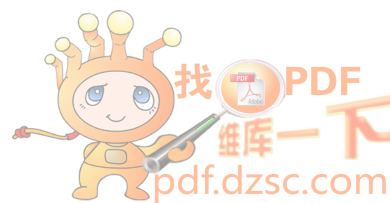
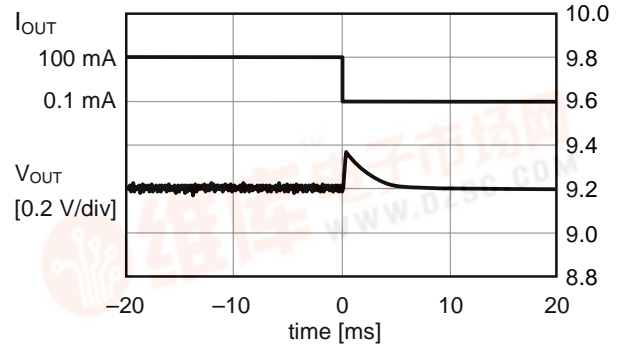

4. 4 Input voltage fluctuations ($V_{OUT} = 9.2\text{ V}$, $I_{OUT} = 100\text{ mA}$, $R_Z = 200\text{ k}\Omega$, $C_Z = 0.01\text{ }\mu\text{F}$)

(1) $f_{OSC} = 1133\text{ kHz}$, $V_{IN} = 2.7\text{ V} \rightarrow 3.7\text{ V}$

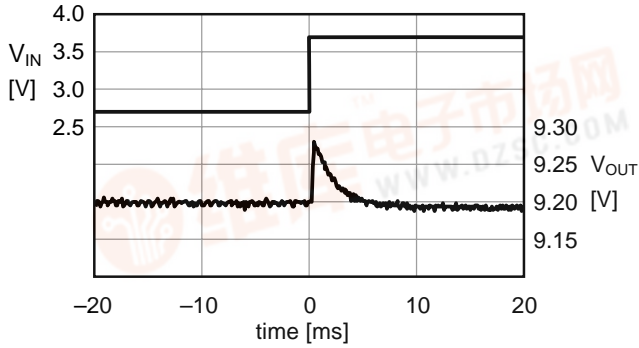

(2) $f_{OSC} = 1133\text{ kHz}$, $V_{IN} = 3.7\text{ V} \rightarrow 2.7\text{ V}$

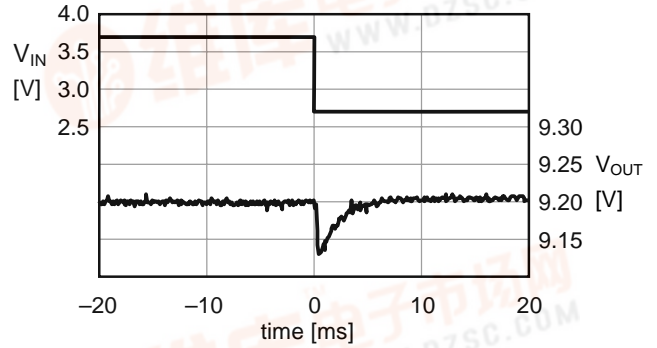

(3) $f_{OSC} = 700\text{ kHz}$, $V_{IN} = 2.7\text{ V} \rightarrow 3.7\text{ V}$

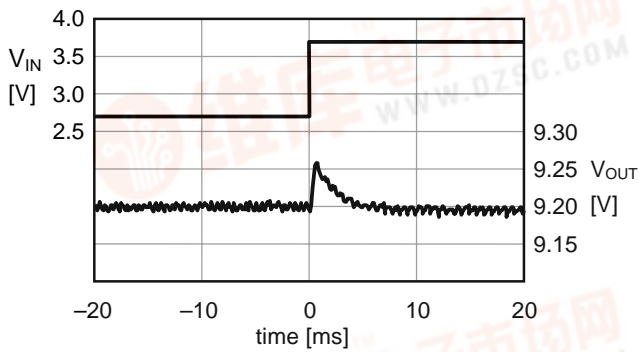

(4) $f_{OSC} = 700\text{ kHz}$, $V_{IN} = 3.7\text{ V} \rightarrow 2.7\text{ V}$

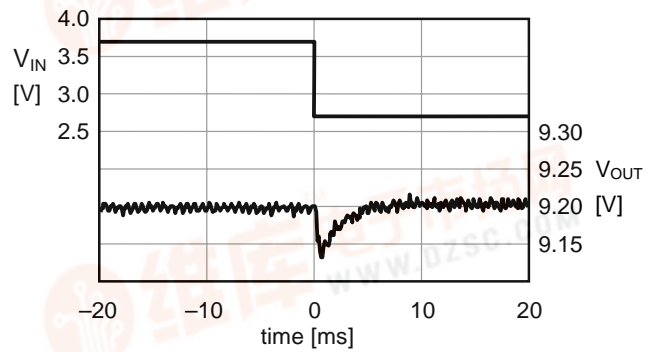

(5) $f_{OSC} = 286\text{ kHz}$, $V_{IN} = 2.7\text{ V} \rightarrow 3.7\text{ V}$

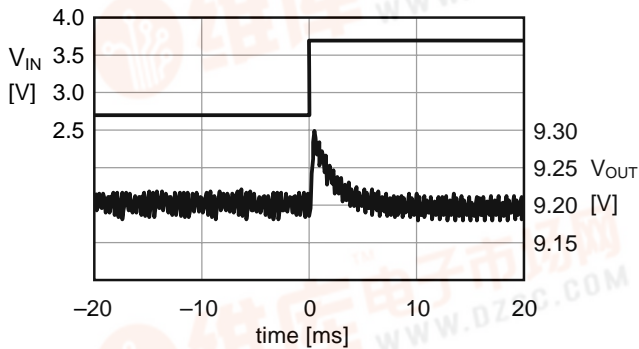

(6) $f_{OSC} = 286\text{ kHz}$, $V_{IN} = 3.7\text{ V} \rightarrow 2.7\text{ V}$

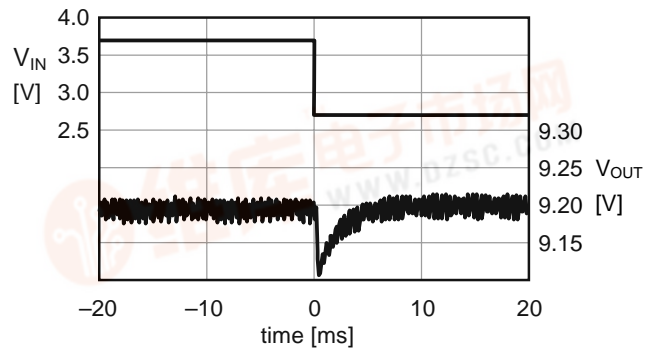

■ Reference Data

1. Reference data for external parts

Table 8 Properties of External Parts

Element Name	Product Name	Manufacture	Characteristics
Inductor	LDR655312T	TDK Corporation	4.7 μ H, DCR ^{*1} = 206 m Ω , I _{MAX} ^{*2} = 0.9 A, Height = 1.2 mm
Diode	RB491D	Rohm Co., Ltd.	V _F ^{*3} = 0.45 V, I _F ^{*4} = 1.0 A
Output capacitor	—	—	16 V, 10 μ F
Transistor	MCH3406	Sanyo Electric Co., Ltd.	V _{DSS} ^{*5} = 20 V, V _{GSS} ^{*6} = \pm 10 V, C _{ISS} ^{*7} = 280 pF, R _{DS(ON)} ^{*8} = 82 m Ω max. (V _{GS} ^{*9} = 2.5 V, I _D ^{*10} = 1 A)

*1. DCR : DC resistance

*2. I_{MAX} : Maximum allowable current

*3. V_F : Forward voltage

*4. I_F : Forward current

*5. V_{DSS} : Drain to source voltage (When between gate and source short circuits)

*6. V_{GSS} : Gate to source voltage (When between drain and source short circuits)

*7. C_{ISS} : Input capacitance

*8. R_{DS(ON)} : Drain to source on resistance

*9. V_{GS} : Gate to source voltage

*10. I_D : Drain current

Caution The values shown in the characteristics column of Table 8 above are based on the materials provided by each manufacturer. However, consider the characteristics of the original materials when using the above products.



2. Reference data (1)

The data of (a) output current (I_{OUT}) vs. efficiency (η) characteristics and (b) output current (I_{OUT}) vs. output voltage (V_{OUT}) characteristics is shown below.

2.1 $V_{OUT} = 13.1\text{ V}$ ($R_{FB1} = 7.5\text{ k}\Omega$, $R_{FB2} = 620\text{ }\Omega$)

(1) $f_{OSC} = 1133\text{ kHz}$, $MaxDuty = 77\%$ ($R_{OSC} = 120\text{ k}\Omega$, $R_{Duty} = 180\text{ k}\Omega$)

(a) I_{OUT} vs. η

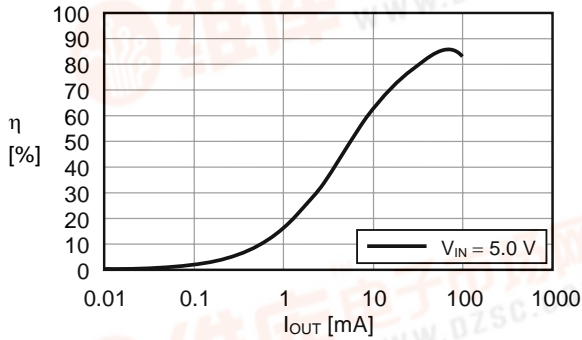

(b) I_{OUT} vs. V_{OUT}

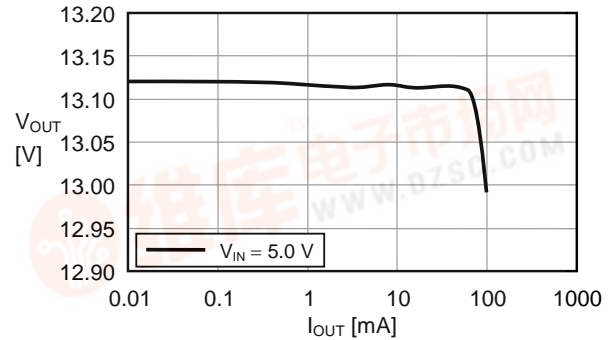

(2) $f_{OSC} = 700\text{ kHz}$, $MaxDuty = 77\%$ ($R_{OSC} = 200\text{ k}\Omega$, $R_{Duty} = 300\text{ k}\Omega$)

(a) I_{OUT} vs. η

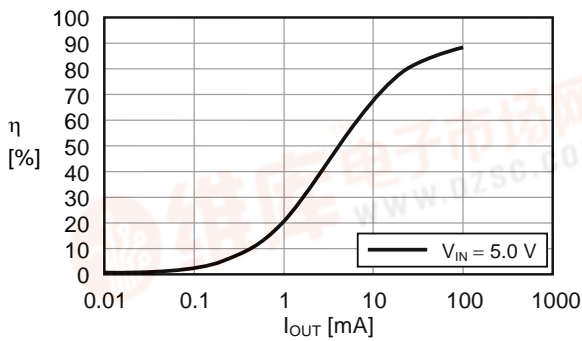

(b) I_{OUT} vs. V_{OUT}

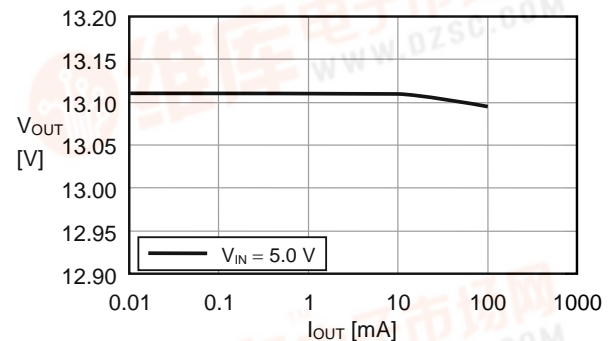

(3) $f_{OSC} = 286\text{ kHz}$, $MaxDuty = 77\%$ ($R_{OSC} = 510\text{ k}\Omega$, $R_{Duty} = 750\text{ k}\Omega$)

(a) I_{OUT} vs. η

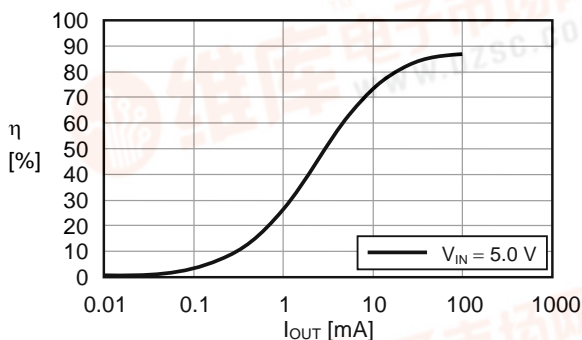

(b) I_{OUT} vs. V_{OUT}

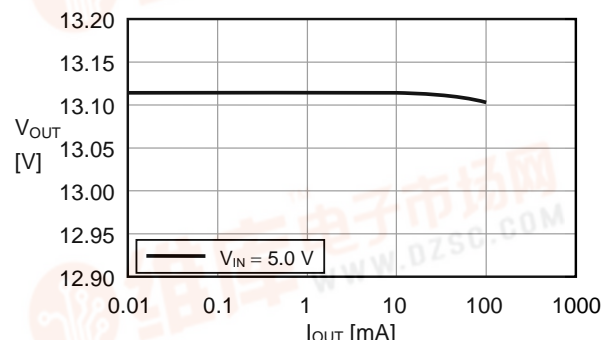

2.2 $V_{OUT} = 9.2\text{ V}$ ($R_{FB1} = 8.2\text{ k}\Omega$, $R_{FB2} = 1.0\text{ k}\Omega$)

(1) $f_{OSC} = 1133\text{ kHz}$, $MaxDuty = 77\%$ ($R_{OSC} = 120\text{ k}\Omega$, $R_{Duty} = 180\text{ k}\Omega$)

(a) I_{OUT} vs. η

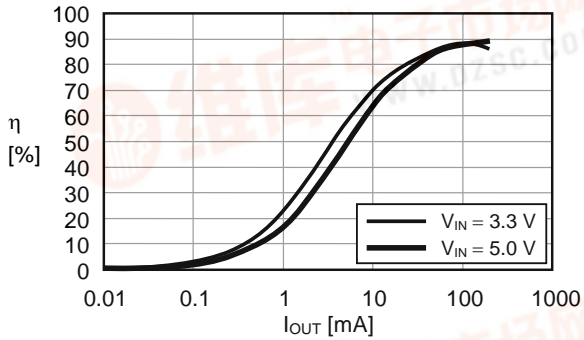

(b) I_{OUT} vs. V_{OUT}

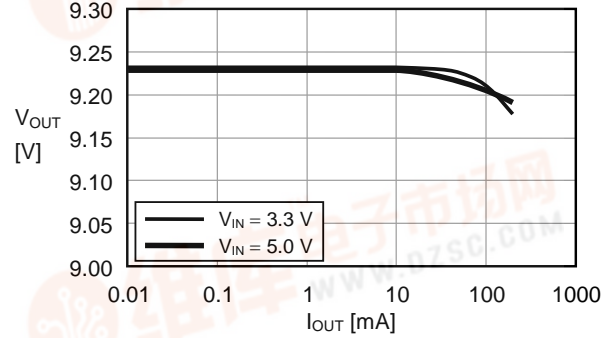

(2) $f_{OSC} = 700\text{ kHz}$, $MaxDuty = 77\%$ ($R_{OSC} = 200\text{ k}\Omega$, $R_{Duty} = 300\text{ k}\Omega$)

(a) I_{OUT} vs. η

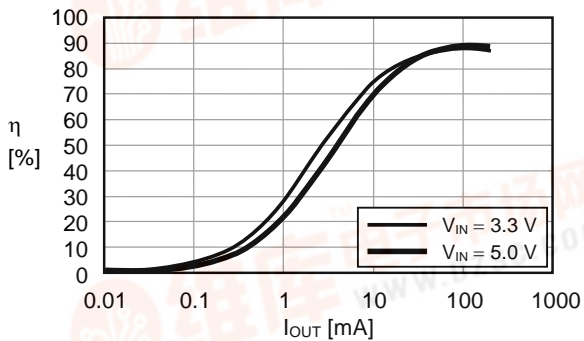

(b) I_{OUT} vs. V_{OUT}

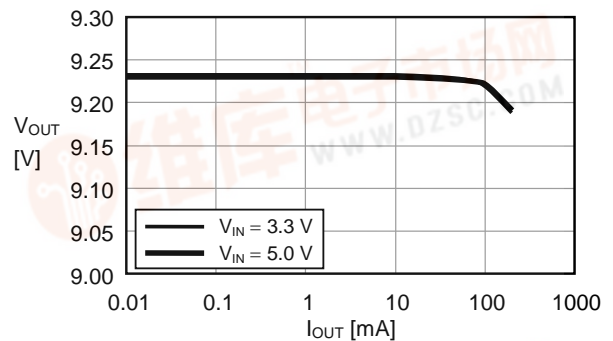

(3) $f_{OSC} = 286\text{ kHz}$, $MaxDuty = 77\%$ ($R_{OSC} = 510\text{ k}\Omega$, $R_{Duty} = 750\text{ k}\Omega$)

(a) I_{OUT} vs. η

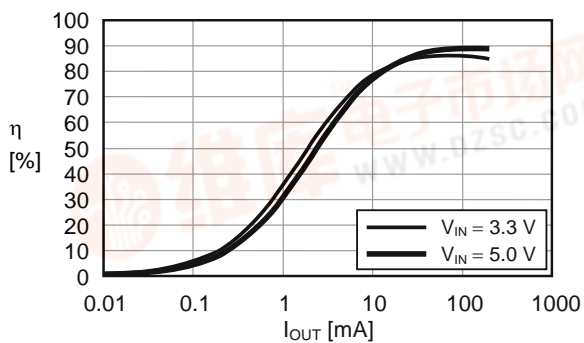

(b) I_{OUT} vs. V_{OUT}

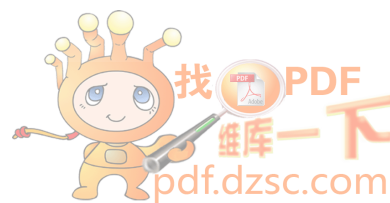
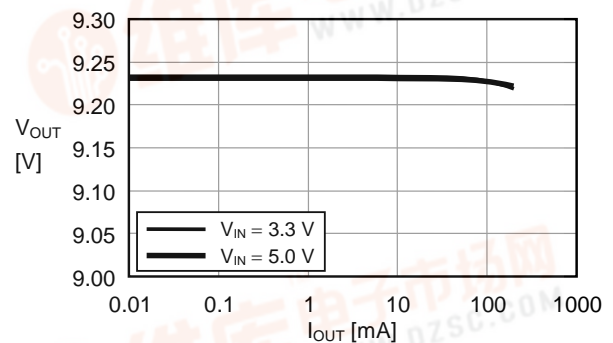

2.3 $V_{OUT} = 6.1\text{ V}$ ($R_{FB1} = 5.1\text{ k}\Omega$, $R_{FB2} = 1.0\text{ k}\Omega$)

(1) $f_{OSC} = 1133\text{ kHz}$, $MaxDuty = 77\%$ ($R_{OSC} = 120\text{ k}\Omega$, $R_{Duty} = 180\text{ k}\Omega$)

(a) I_{OUT} vs. η

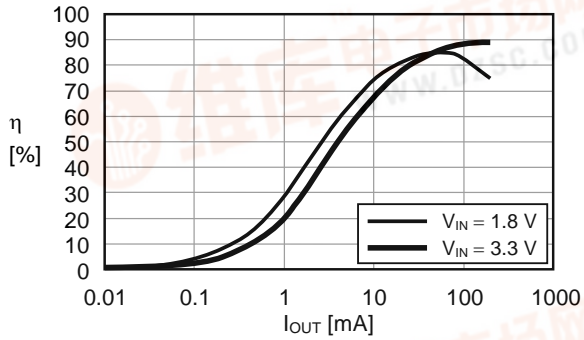

(b) I_{OUT} vs. V_{OUT}

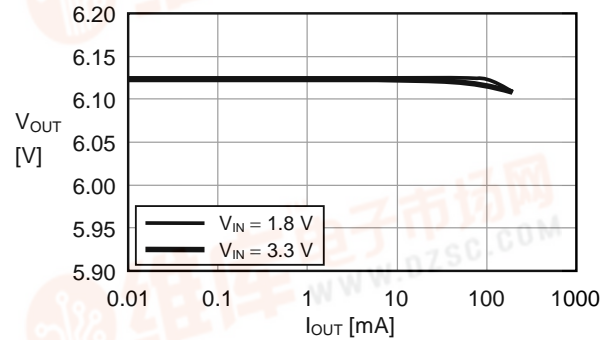

(2) $f_{OSC} = 700\text{ kHz}$, $MaxDuty = 77\%$ ($R_{OSC} = 200\text{ k}\Omega$, $R_{Duty} = 300\text{ k}\Omega$)

(a) I_{OUT} vs. η

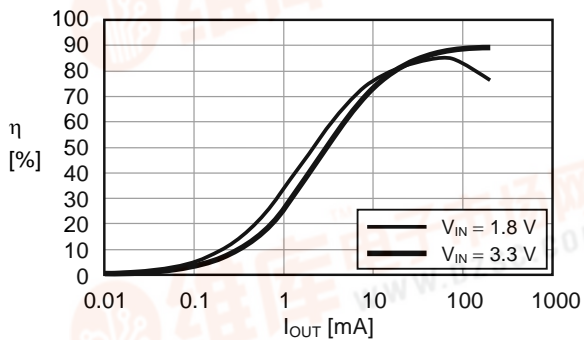

(b) I_{OUT} vs. V_{OUT}

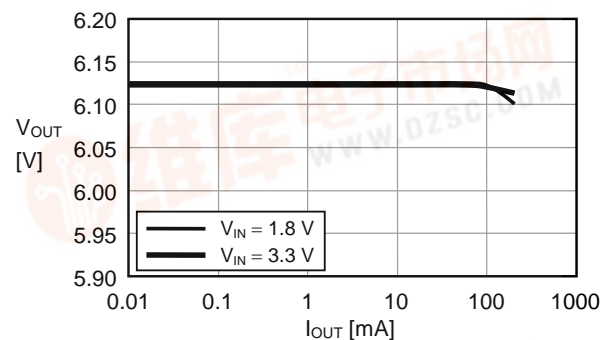

(3) $f_{OSC} = 286\text{ kHz}$, $MaxDuty = 77\%$ ($R_{OSC} = 510\text{ k}\Omega$, $R_{Duty} = 750\text{ k}\Omega$)

(a) I_{OUT} vs. η

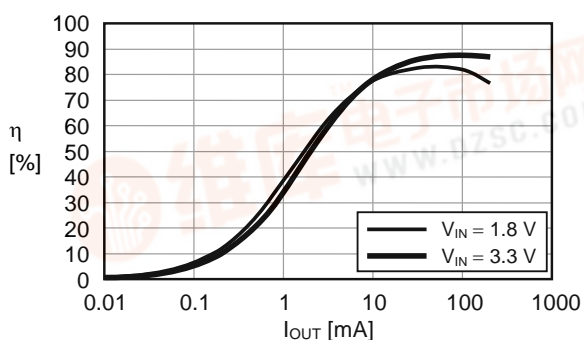

(b) I_{OUT} vs. V_{OUT}

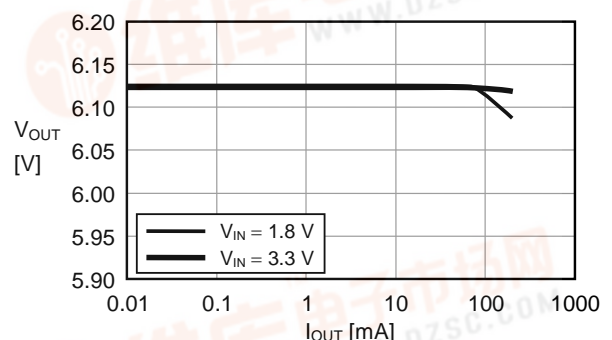

3. Reference data (2)

The data of output current (I_{OUT}) vs. ripple voltage (V_r) characteristics is shown below.

3.1 $V_{OUT} = 13.1 V$ ($R_{FB1} = 7.5 k\Omega$, $R_{FB2} = 620 \Omega$)

(1) $f_{OSC} = 1133 kHz$, MaxDuty = 77 % ($R_{OSC} = 120 k\Omega$, $R_{Duty} = 180 k\Omega$)

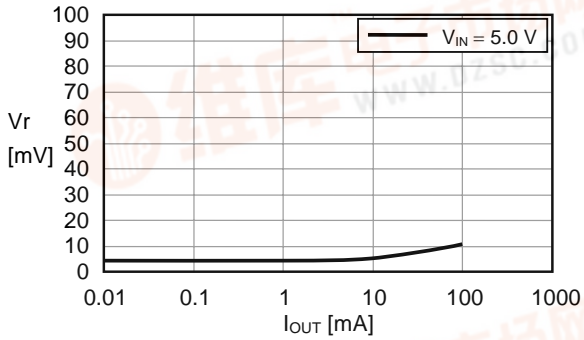

(2) $f_{OSC} = 700 kHz$, MaxDuty = 77 % ($R_{OSC} = 200 k\Omega$, $R_{Duty} = 300 k\Omega$)

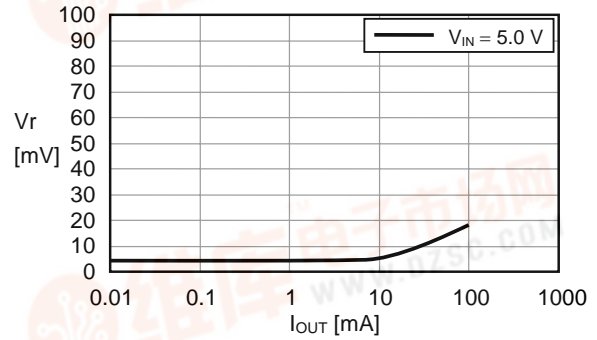

(3) $f_{OSC} = 286 kHz$, MaxDuty = 77 % ($R_{OSC} = 510 k\Omega$, $R_{Duty} = 750 k\Omega$)

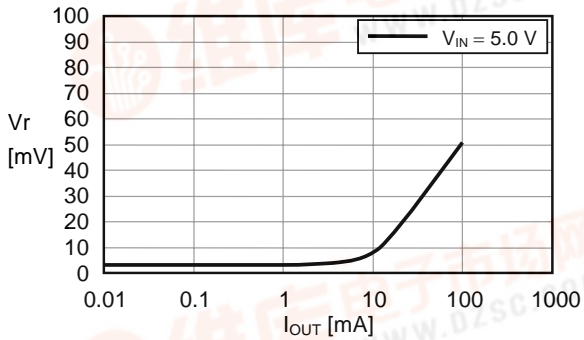

3.2 $V_{OUT} = 9.2 V$ ($R_{FB1} = 8.2 k\Omega$, $R_{FB2} = 1.0 k\Omega$)

(1) $f_{OSC} = 1133 kHz$, MaxDuty = 77 % ($R_{OSC} = 120 k\Omega$, $R_{Duty} = 180 k\Omega$)

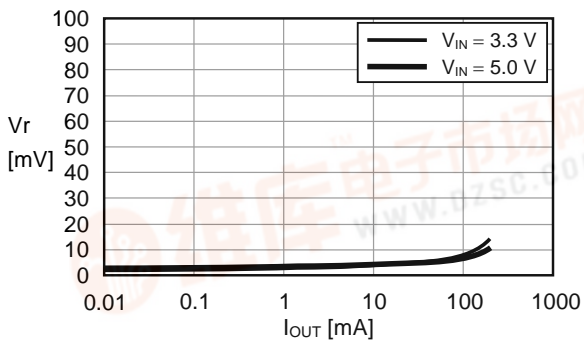

(2) $f_{OSC} = 700 kHz$, MaxDuty = 77 % ($R_{OSC} = 200 k\Omega$, $R_{Duty} = 300 k\Omega$)

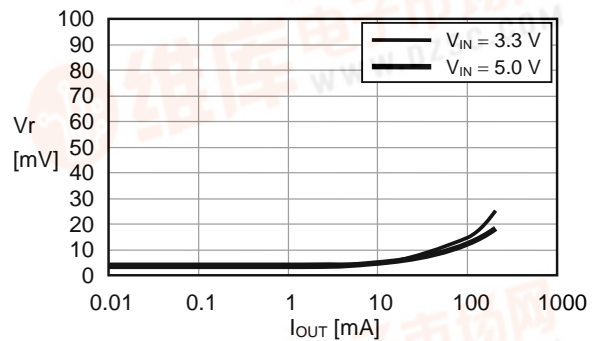

(3) $f_{OSC} = 286 kHz$, MaxDuty = 77 % ($R_{OSC} = 510 k\Omega$, $R_{Duty} = 750 k\Omega$)

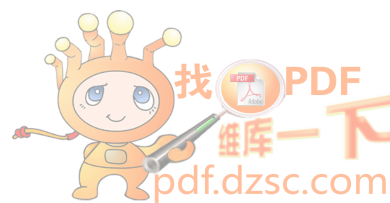
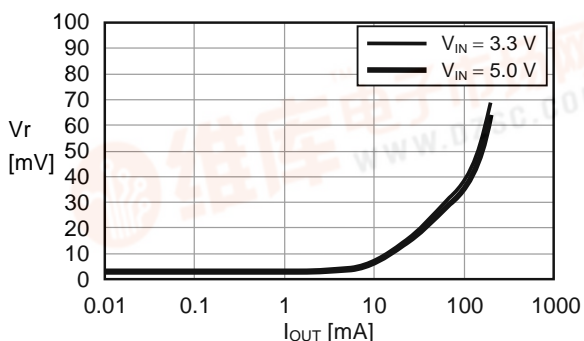

3.3 $V_{OUT} = 6.1 V$ ($R_{FB1} = 5.1 k\Omega$, $R_{FB2} = 1.0 k\Omega$)

(1) $f_{OSC} = 1133 kHz$, MaxDuty = 77 % ($R_{OSC} = 120 k\Omega$, $R_{Duty} = 180 k\Omega$)

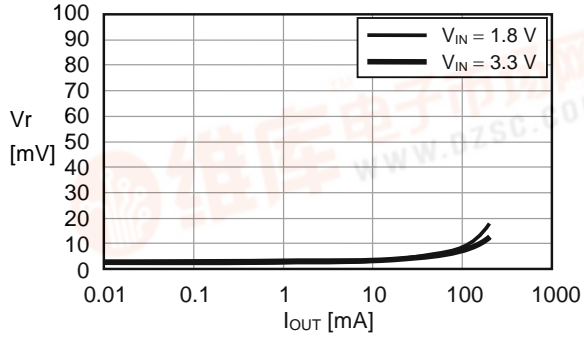

(2) $f_{OSC} = 700 kHz$, MaxDuty = 77 % ($R_{OSC} = 200 k\Omega$, $R_{Duty} = 300 k\Omega$)

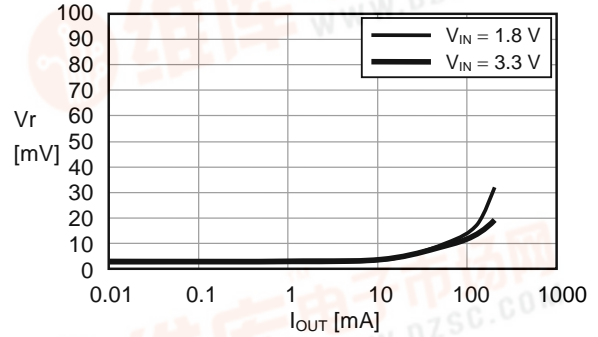

(3) $f_{OSC} = 286 kHz$, MaxDuty = 77 % ($R_{OSC} = 510 k\Omega$, $R_{Duty} = 750 k\Omega$)

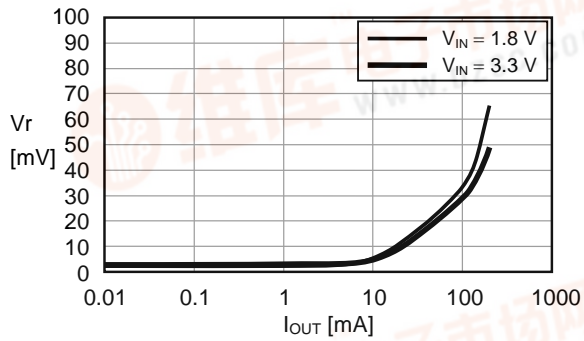

■ Marking Specification

(1) 8-Pin SON(A)

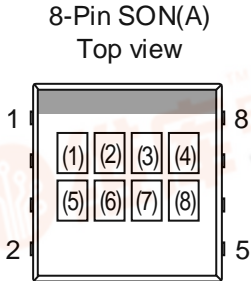

(1) ~ (3) Product code (Refer to **Product name vs. Product code**)
(4) ~ (8) Lot number

Product name vs. Product code

(a) S-8337Series

Product name	Product code		
	(1)	(2)	(3)
S-8337AAAA-P8T1G	O	B	A
S-8337AAAB-P8T1G	O	B	B
S-8337AAAC-P8T1G	O	B	2
S-8337AABA-P8T1G	O	B	C
S-8337AABB-P8T1G	O	B	D
S-8337AABC-P8T1G	O	B	E
S-8337AACA-P8T1G	O	B	F
S-8337AACB-P8T1G	O	B	G
S-8337AACC-P8T1G	O	B	H
S-8337AADA-P8T1G	O	B	I
S-8337AADB-P8T1G	O	B	J
S-8337AADC-P8T1G	O	B	K
S-8337AAEA-P8T1G	O	B	L
S-8337AAEB-P8T1G	O	B	M
S-8337AAEC-P8T1G	O	B	N
S-8337AAFA-P8T1G	O	B	O
S-8337AAFB-P8T1G	O	B	P
S-8337AAFC-P8T1G	O	B	Q
S-8337AAGA-P8T1G	O	B	R
S-8337AAGB-P8T1G	O	B	S
S-8337AAGC-P8T1G	O	B	T
S-8337AAHA-P8T1G	O	B	U
S-8337AAHB-P8T1G	O	B	V
S-8337AAHC-P8T1G	O	B	W
S-8337AAIA-P8T1G	O	B	X
S-8337AAIB-P8T1G	O	B	Y
S-8337AAIC-P8T1G	O	B	Z
S-8337ABAA-P8T1G	O	D	A
S-8337ABAB-P8T1G	O	D	B
S-8337ABAC-P8T1G	O	D	2
S-8337ABBA-P8T1G	O	D	C
S-8337ABBB-P8T1G	O	D	D
S-8337ABBC-P8T1G	O	D	E
S-8337ABCA-P8T1G	O	D	F
S-8337ABCB-P8T1G	O	D	G
S-8337ABCC-P8T1G	O	D	H
S-8337ABDA-P8T1G	O	D	I
S-8337ABDB-P8T1G	O	D	J
S-8337ABDC-P8T1G	O	D	K
S-8337ABEA-P8T1G	O	D	L
S-8337ABEB-P8T1G	O	D	M

Product name	Product code		
	(1)	(2)	(3)
S-8337ABEC-P8T1G	O	D	N
S-8337ABFA-P8T1G	O	D	O
S-8337ABFB-P8T1G	O	D	P
S-8337ABFC-P8T1G	O	D	Q
S-8337ABGA-P8T1G	O	D	R
S-8337ABGB-P8T1G	O	D	S
S-8337ABGC-P8T1G	O	D	T
S-8337ABHA-P8T1G	O	D	U
S-8337ABHB-P8T1G	O	D	V
S-8337ABHC-P8T1G	O	D	W
S-8337ABIA-P8T1G	O	D	X
S-8337ABIB-P8T1G	O	D	Y
S-8337ABIC-P8T1G	O	D	Z
S-8337ACAA-P8T1G	O	J	A
S-8337ACAB-P8T1G	O	J	B
S-8337ACAC-P8T1G	O	J	2
S-8337ACBA-P8T1G	O	J	C
S-8337ACBB-P8T1G	O	J	D
S-8337ACBC-P8T1G	O	J	E
S-8337ACCA-P8T1G	O	J	F
S-8337ACCB-P8T1G	O	J	G
S-8337ACCC-P8T1G	O	J	H
S-8337ACDA-P8T1G	O	J	I
S-8337ACDB-P8T1G	O	J	J
S-8337ACDC-P8T1G	O	J	K
S-8337ACEA-P8T1G	O	J	L
S-8337ACEB-P8T1G	O	J	M
S-8337ACEC-P8T1G	O	J	N
S-8337ACFA-P8T1G	O	J	O
S-8337ACFB-P8T1G	O	J	P
S-8337ACFC-P8T1G	O	J	Q
S-8337ACGA-P8T1G	O	J	R
S-8337ACGB-P8T1G	O	J	S
S-8337ACGC-P8T1G	O	J	T
S-8337ACHA-P8T1G	O	J	U
S-8337ACHB-P8T1G	O	J	V
S-8337ACHC-P8T1G	O	J	W
S-8337ACIA-P8T1G	O	J	X
S-8337ACIB-P8T1G	O	J	Y
S-8337ACIC-P8T1G	O	J	Z



(b) S-8338 Series

Product name	Product code		
	(1)	(2)	(3)
S-8338AAAA-P8T1G	O	C	A
S-8338AAAB-P8T1G	O	C	B
S-8338AAAC-P8T1G	O	C	2
S-8338AABA-P8T1G	O	C	C
S-8338AABB-P8T1G	O	C	D
S-8338AABC-P8T1G	O	C	E
S-8338AACA-P8T1G	O	C	F
S-8338AACB-P8T1G	O	C	G
S-8338AACC-P8T1G	O	C	H
S-8338AADA-P8T1G	O	C	I
S-8338AADB-P8T1G	O	C	J
S-8338AADC-P8T1G	O	C	K
S-8338AAEA-P8T1G	O	C	L
S-8338AAEB-P8T1G	O	C	M
S-8338AAEC-P8T1G	O	C	N
S-8338AAFA-P8T1G	O	C	O
S-8338AAFB-P8T1G	O	C	P
S-8338AAFC-P8T1G	O	C	Q
S-8338AAGA-P8T1G	O	C	R
S-8338AAGB-P8T1G	O	C	S
S-8338AAGC-P8T1G	O	C	T
S-8338AAHA-P8T1G	O	C	U
S-8338AAHB-P8T1G	O	C	V
S-8338AAHC-P8T1G	O	C	W
S-8338AAIA-P8T1G	O	C	X
S-8338AAIB-P8T1G	O	C	Y
S-8338AAIC-P8T1G	O	C	Z
S-8338ABAA-P8T1G	O	I	A
S-8338ABAB-P8T1G	O	I	B
S-8338ABAC-P8T1G	O	I	2
S-8338ABBA-P8T1G	O	I	C
S-8338ABBB-P8T1G	O	I	D
S-8338ABBC-P8T1G	O	I	E
S-8338ABCA-P8T1G	O	I	F
S-8338ABCB-P8T1G	O	I	G
S-8338ABCC-P8T1G	O	I	H
S-8338ABDA-P8T1G	O	I	I
S-8338ABDB-P8T1G	O	I	J
S-8338ABDC-P8T1G	O	I	K
S-8338ABEA-P8T1G	O	I	L
S-8338ABEB-P8T1G	O	I	M

Product name	Product code		
	(1)	(2)	(3)
S-8338ABEC-P8T1G	O	I	N
S-8338ABFA-P8T1G	O	I	O
S-8338ABFB-P8T1G	O	I	P
S-8338ABFC-P8T1G	O	I	Q
S-8338ABGA-P8T1G	O	I	R
S-8338ABGB-P8T1G	O	I	S
S-8338ABGC-P8T1G	O	I	T
S-8338ABHA-P8T1G	O	I	U
S-8338ABHB-P8T1G	O	I	V
S-8338ABHC-P8T1G	O	I	W
S-8338ABIA-P8T1G	O	I	X
S-8338ABIB-P8T1G	O	I	Y
S-8338ABIC-P8T1G	O	I	Z
S-8338ACAA-P8T1G	O	K	A
S-8338ACAB-P8T1G	O	K	B
S-8338ACAC-P8T1G	O	K	2
S-8338ACBA-P8T1G	O	K	C
S-8338ACBB-P8T1G	O	K	D
S-8338ACBC-P8T1G	O	K	E
S-8338ACCA-P8T1G	O	K	F
S-8338ACCB-P8T1G	O	K	G
S-8338ACCC-P8T1G	O	K	H
S-8338ACDA-P8T1G	O	K	I
S-8338ACDB-P8T1G	O	K	J
S-8338ACDC-P8T1G	O	K	K
S-8338ACEA-P8T1G	O	K	L
S-8338ACEB-P8T1G	O	K	M
S-8338ACEC-P8T1G	O	K	N
S-8338ACFA-P8T1G	O	K	O
S-8338ACFB-P8T1G	O	K	P
S-8338ACFC-P8T1G	O	K	Q
S-8338ACGA-P8T1G	O	K	R
S-8338ACGB-P8T1G	O	K	S
S-8338ACGC-P8T1G	O	K	T
S-8338ACHA-P8T1G	O	K	U
S-8338ACHB-P8T1G	O	K	V
S-8338ACHC-P8T1G	O	K	W
S-8338ACIA-P8T1G	O	K	X
S-8338ACIB-P8T1G	O	K	Y
S-8338ACIC-P8T1G	O	K	Z

(2) 8-Pin TSSOP

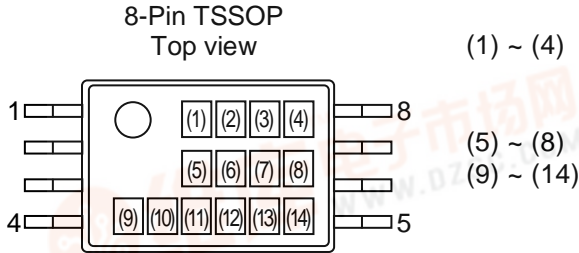

Product name: 8337 or 8338 (Fixed)
 8337 indicates S-8337 series.
 8338 indicates S-8338 series.
 Function code (Refer to **Product name vs. Function code**)
 Lot number

Product name vs. Function code

(a) S-8337 Series

Product name	Function code			
	(5)	(6)	(7)	(8)
S-8337AAAA-T8T1x	A	A	A	A
S-8337AAAB-T8T1x	A	A	A	B
S-8337AAAC-T8T1x	A	A	A	C
S-8337AABA-T8T1x	A	A	B	A
S-8337AABB-T8T1x	A	A	B	B
S-8337AABC-T8T1x	A	A	B	C
S-8337AACA-T8T1x	A	A	C	A
S-8337AACB-T8T1x	A	A	C	B
S-8337AACC-T8T1x	A	A	C	C
S-8337AADA-T8T1x	A	A	D	A
S-8337AADB-T8T1x	A	A	D	B
S-8337AADC-T8T1x	A	A	D	C
S-8337AAEA-T8T1x	A	A	E	A
S-8337AAEB-T8T1x	A	A	E	B
S-8337AAEC-T8T1x	A	A	E	C
S-8337AAFA-T8T1x	A	A	F	A
S-8337AAFB-T8T1x	A	A	F	B
S-8337AAFC-T8T1x	A	A	F	C
S-8337AAGA-T8T1x	A	A	G	A
S-8337AAGB-T8T1x	A	A	G	B
S-8337AAGC-T8T1x	A	A	G	C
S-8337AAHA-T8T1x	A	A	H	A
S-8337AAHB-T8T1x	A	A	H	B
S-8337AAHC-T8T1x	A	A	H	C
S-8337AAIA-T8T1x	A	A	I	A
S-8337AAIB-T8T1x	A	A	I	B
S-8337AAIC-T8T1x	A	A	I	C
S-8337ABAA-T8T1x	A	B	A	A
S-8337ABAB-T8T1x	A	B	A	B
S-8337ABAC-T8T1x	A	B	A	C
S-8337ABBA-T8T1x	A	B	B	A
S-8337ABBB-T8T1x	A	B	B	B
S-8337ABBC-T8T1x	A	B	B	C
S-8337ABCA-T8T1x	A	B	C	A
S-8337ABCB-T8T1x	A	B	C	B
S-8337ABCC-T8T1x	A	B	C	C
S-8337ABDA-T8T1x	A	B	D	A
S-8337ABDB-T8T1x	A	B	D	B
S-8337ABDC-T8T1x	A	B	D	C
S-8337ABEA-T8T1x	A	B	E	A
S-8337ABEB-T8T1x	A	B	E	B

Product name	Function code			
	(5)	(6)	(7)	(8)
S-8337ABEC-T8T1x	A	B	E	C
S-8337ABFA-T8T1x	A	B	F	A
S-8337ABFB-T8T1x	A	B	F	B
S-8337ABFC-T8T1x	A	B	F	C
S-8337ABGA-T8T1x	A	B	G	A
S-8337ABGB-T8T1x	A	B	G	B
S-8337ABGC-T8T1x	A	B	G	C
S-8337ABHA-T8T1x	A	B	H	A
S-8337ABHB-T8T1x	A	B	H	B
S-8337ABHC-T8T1x	A	B	H	C
S-8337ABIA-T8T1x	A	B	I	A
S-8337ABIB-T8T1x	A	B	I	B
S-8337ABIC-T8T1x	A	B	I	C
S-8337ACAA-T8T1x	A	C	A	A
S-8337ACAB-T8T1x	A	C	A	B
S-8337ACAC-T8T1x	A	C	A	C
S-8337ACBA-T8T1x	A	C	B	A
S-8337ACBB-T8T1x	A	C	B	B
S-8337ACBC-T8T1x	A	C	B	C
S-8337ACCA-T8T1x	A	C	C	A
S-8337ACCB-T8T1x	A	C	C	B
S-8337ACCC-T8T1x	A	C	C	C
S-8337ACDA-T8T1x	A	C	D	A
S-8337ACDB-T8T1x	A	C	D	B
S-8337ACDC-T8T1x	A	C	D	C
S-8337ACEA-T8T1x	A	C	E	A
S-8337ACEB-T8T1x	A	C	E	B
S-8337ACEC-T8T1x	A	C	E	C
S-8337ACFA-T8T1x	A	C	F	A
S-8337ACFB-T8T1x	A	C	F	B
S-8337ACFC-T8T1x	A	C	F	C
S-8337ACGA-T8T1x	A	C	G	A
S-8337ACGB-T8T1x	A	C	G	B
S-8337ACGC-T8T1x	A	C	G	C
S-8337ACHA-T8T1x	A	C	H	A
S-8337ACHB-T8T1x	A	C	H	B
S-8337ACHC-T8T1x	A	C	H	C
S-8337ACIA-T8T1x	A	C	I	A
S-8337ACIB-T8T1x	A	C	I	B
S-8337ACIC-T8T1x	A	C	I	C

Remark 1. x: G or U

2. Please select products of environmental code = U for Sn 100%, halogen-free products.



(b) S-8338 Series

Product name	Function code			
	(5)	(6)	(7)	(8)
S-8338AAAA-T8T1x	A	A	A	A
S-8338AAAB-T8T1x	A	A	A	B
S-8338AAAC-T8T1x	A	A	A	C
S-8338AABA-T8T1x	A	A	B	A
S-8338AABB-T8T1x	A	A	B	B
S-8338AABC-T8T1x	A	A	B	C
S-8338AACA-T8T1x	A	A	C	A
S-8338AACB-T8T1x	A	A	C	B
S-8338AACC-T8T1x	A	A	C	C
S-8338AADA-T8T1x	A	A	D	A
S-8338AADB-T8T1x	A	A	D	B
S-8338AADC-T8T1x	A	A	D	C
S-8338AAEA-T8T1x	A	A	E	A
S-8338AAEB-T8T1x	A	A	E	B
S-8338AAEC-T8T1x	A	A	E	C
S-8338AAFA-T8T1x	A	A	F	A
S-8338AAFB-T8T1x	A	A	F	B
S-8338AAFC-T8T1x	A	A	F	C
S-8338AAGA-T8T1x	A	A	G	A
S-8338AAGB-T8T1x	A	A	G	B
S-8338AAGC-T8T1x	A	A	G	C
S-8338AAHA-T8T1x	A	A	H	A
S-8338AAHB-T8T1x	A	A	H	B
S-8338AAHC-T8T1x	A	A	H	C
S-8338AAIA-T8T1x	A	A	I	A
S-8338AAIB-T8T1x	A	A	I	B
S-8338AAIC-T8T1x	A	A	I	C
S-8338ABAA-T8T1x	A	B	A	A
S-8338ABAB-T8T1x	A	B	A	B
S-8338ABAC-T8T1x	A	B	A	C
S-8338ABBA-T8T1x	A	B	B	A
S-8338ABBB-T8T1x	A	B	B	B
S-8338ABBC-T8T1x	A	B	B	C
S-8338ABCA-T8T1x	A	B	C	A
S-8338ABCB-T8T1x	A	B	C	B
S-8338ABCC-T8T1x	A	B	C	C
S-8338ABDA-T8T1x	A	B	D	A
S-8338ABDB-T8T1x	A	B	D	B
S-8338ABDC-T8T1x	A	B	D	C
S-8338ABEA-T8T1x	A	B	E	A
S-8338ABEB-T8T1x	A	B	E	B

Product name	Function code			
	(5)	(6)	(7)	(8)
S-8338ABEC-T8T1x	A	B	E	C
S-8338ABFA-T8T1x	A	B	F	A
S-8338ABFB-T8T1x	A	B	F	B
S-8338ABFC-T8T1x	A	B	F	C
S-8338ABGA-T8T1x	A	B	G	A
S-8338ABGB-T8T1x	A	B	G	B
S-8338ABGC-T8T1x	A	B	G	C
S-8338ABHA-T8T1x	A	B	H	A
S-8338ABHB-T8T1x	A	B	H	B
S-8338ABHC-T8T1x	A	B	H	C
S-8338ABIA-T8T1x	A	B	I	A
S-8338ABIB-T8T1x	A	B	I	B
S-8338ABIC-T8T1x	A	B	I	C
S-8338ACAA-T8T1x	A	C	A	A
S-8338ACAB-T8T1x	A	C	A	B
S-8338ACAC-T8T1x	A	C	A	C
S-8338ACBA-T8T1x	A	C	B	A
S-8338ACBB-T8T1x	A	C	B	B
S-8338ACBC-T8T1x	A	C	B	C
S-8338ACCA-T8T1x	A	C	C	A
S-8338ACCB-T8T1x	A	C	C	B
S-8338ACCC-T8T1x	A	C	C	C
S-8338ACDA-T8T1x	A	C	D	A
S-8338ACDB-T8T1x	A	C	D	B
S-8338ACDC-T8T1x	A	C	D	C
S-8338ACEA-T8T1x	A	C	E	A
S-8338ACEB-T8T1x	A	C	E	B
S-8338ACEC-T8T1x	A	C	E	C
S-8338ACFA-T8T1x	A	C	F	A
S-8338ACFB-T8T1x	A	C	F	B
S-8338ACFC-T8T1x	A	C	F	C
S-8338ACGA-T8T1x	A	C	G	A
S-8338ACGB-T8T1x	A	C	G	B
S-8338ACGC-T8T1x	A	C	G	C
S-8338ACHA-T8T1x	A	C	H	A
S-8338ACHB-T8T1x	A	C	H	B
S-8338ACHC-T8T1x	A	C	H	C
S-8338ACIA-T8T1x	A	C	I	A
S-8338ACIB-T8T1x	A	C	I	B
S-8338ACIC-T8T1x	A	C	I	C

Remark 1. x: G or U

2. Please select products of environmental code = U for Sn 100%, halogen-free products.



查询S-8338供应商

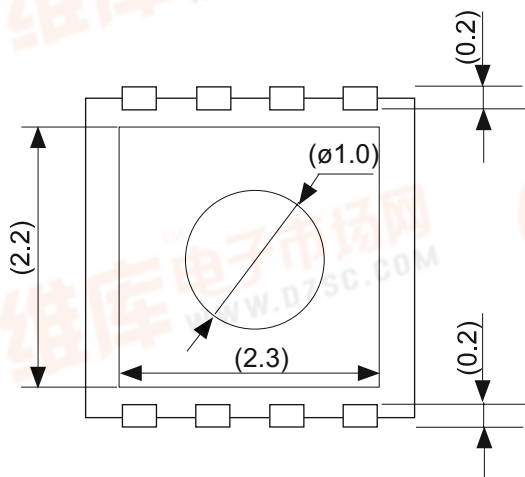
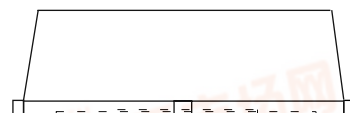
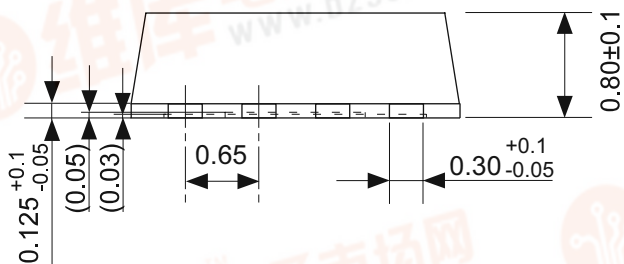
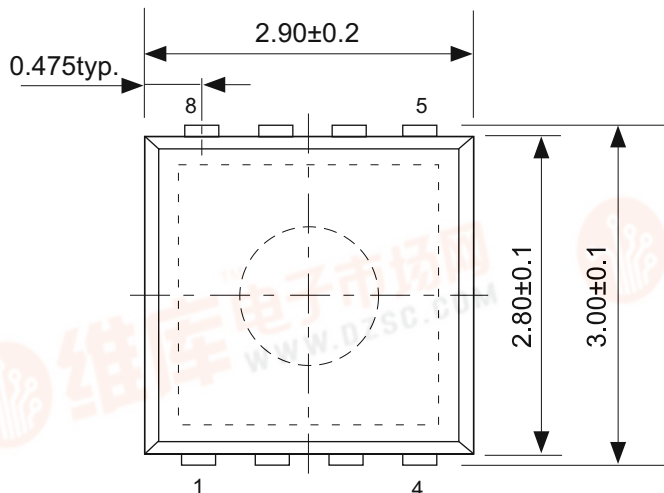

No. PN008-A-P-SD-1.1

TITLE	SON8A-A-PKG Dimensions
No.	PN008-A-P-SD-1.1
SCALE	
UNIT	mm
Seiko Instruments Inc.	

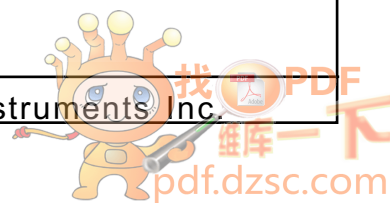

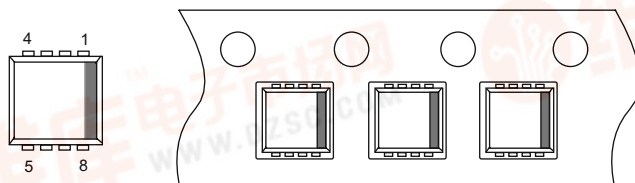
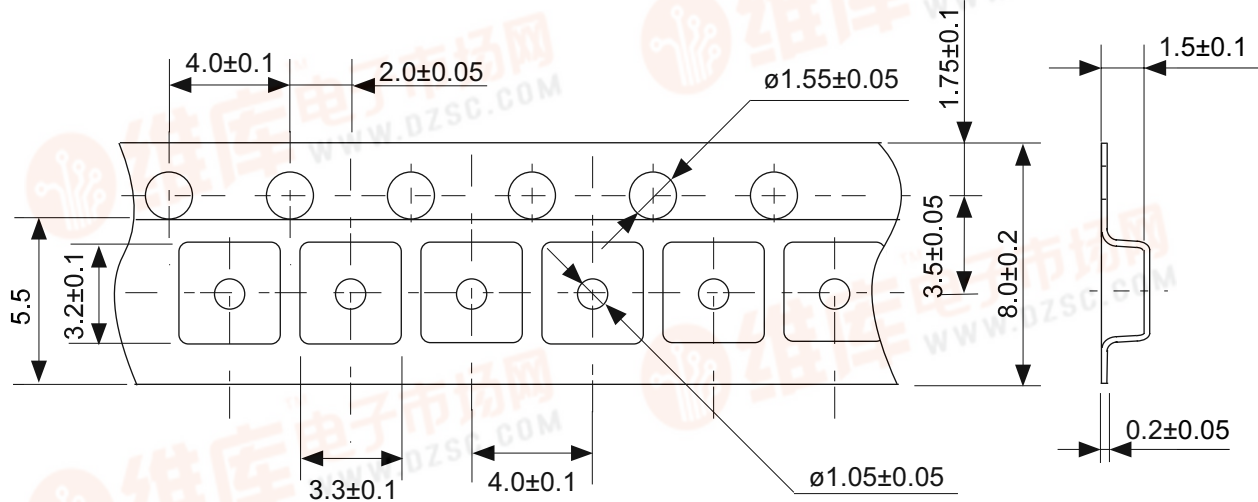

Feed direction

No. PN008-A-C-SD-1.1

TITLE	SON8A-A-Carrier Tape
No.	PN008-A-C-SD-1.1
SCALE	
UNIT	mm
Seiko Instruments Inc.	

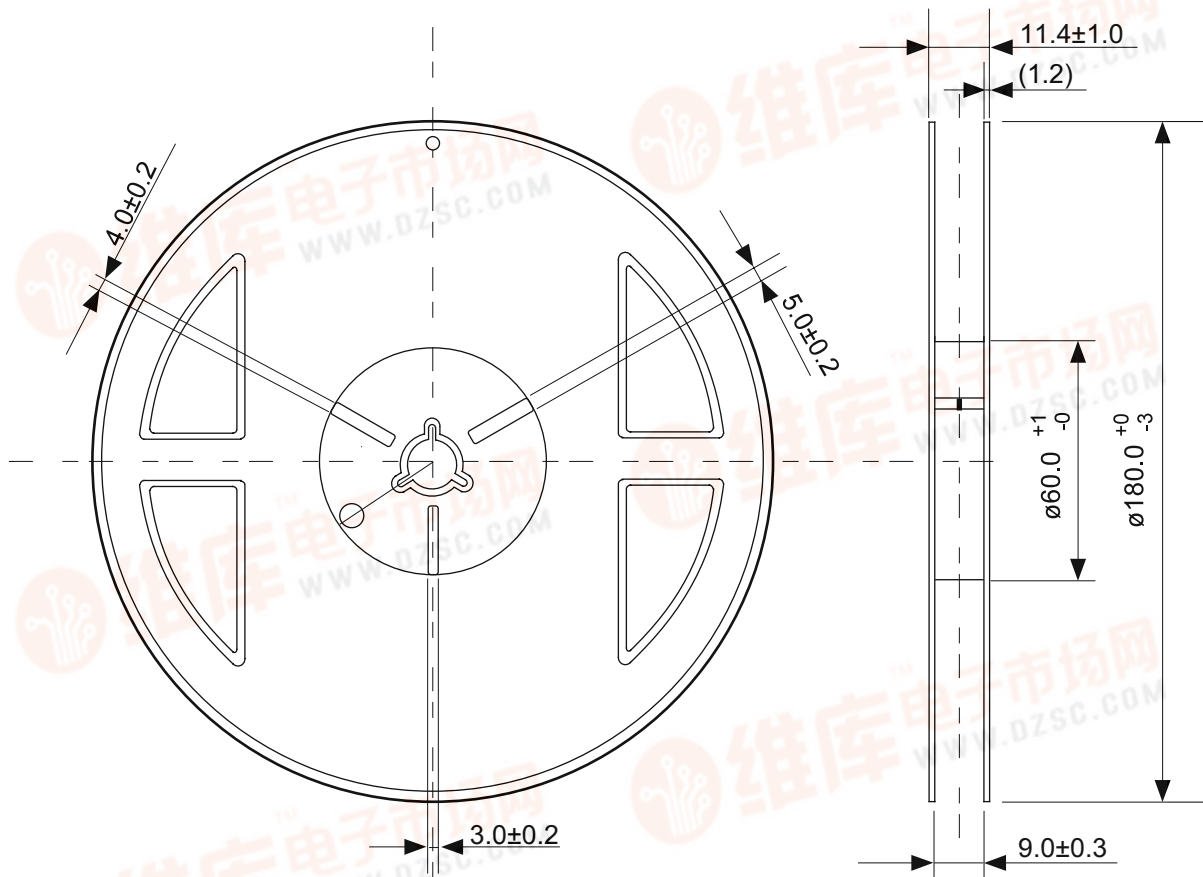

Enlarged drawing in the central part

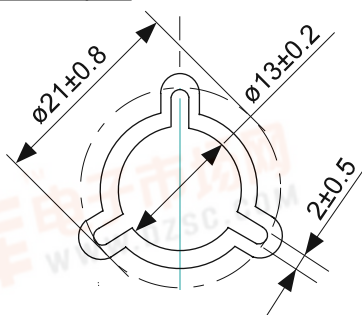

No. PN008-A-R-SD-1.1

TITLE	SON8A-A-Reel		
No.	PN008-A-R-SD-1.1		
SCALE		QTY.	3000
UNIT	mm		
Seiko Instruments Inc.			

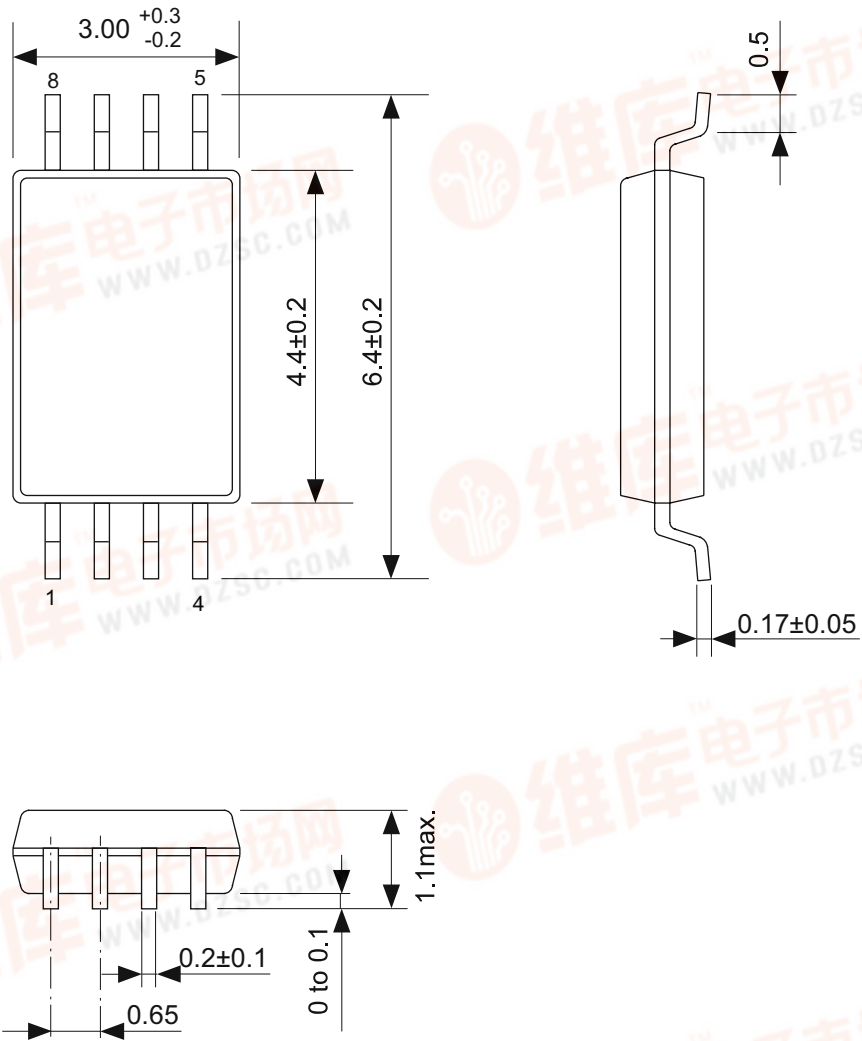

No. FT008-A-P-SD-1.1

TITLE	TSSOP8-E-PKG Dimensions
No.	FT008-A-P-SD-1.1
SCALE	
UNIT	mm
Seiko Instruments Inc.	

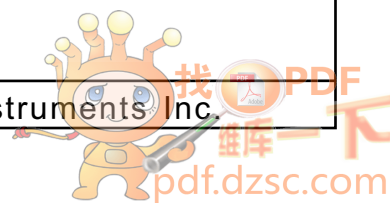

查询S-8338供应商

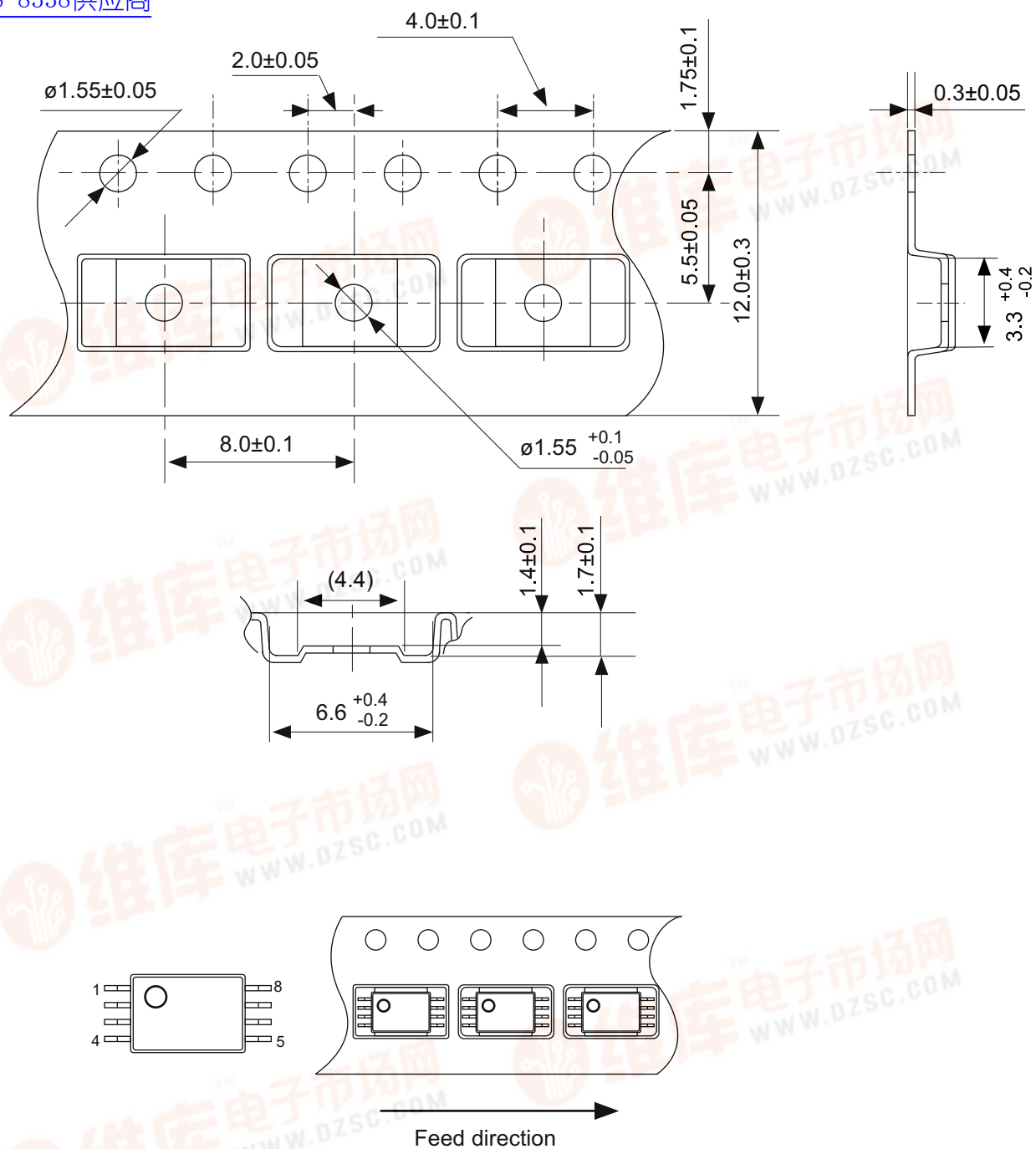

No. FT008-E-C-SD-1.0

TITLE	TSSOP8-E-Carrier Tape
No.	FT008-E-C-SD-1.0
SCALE	
UNIT	mm
Seiko Instruments Inc.	

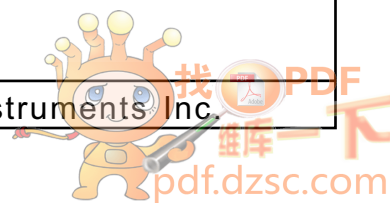

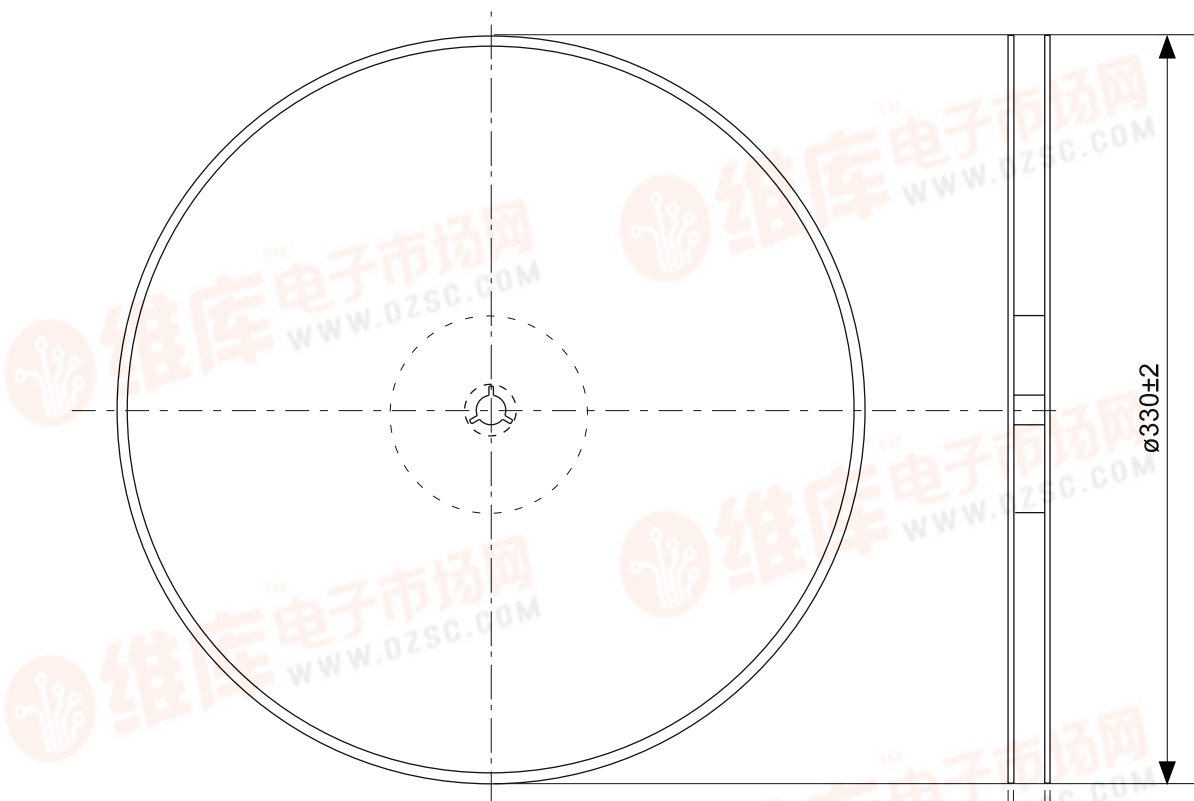

Enlarged drawing in the central part

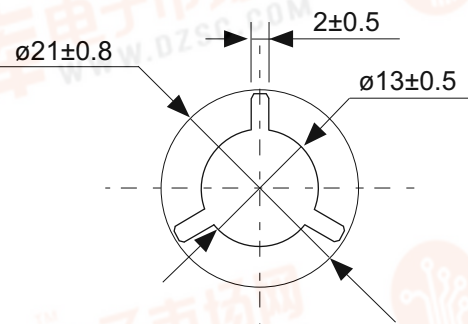

No. FT008-E-R-SD-1.0

TITLE	TSSOP8-E-Reel		
No.	FT008-E-R-SD-1.0		
SCALE		QTY.	3,000
UNIT	mm		
Seiko Instruments Inc.			

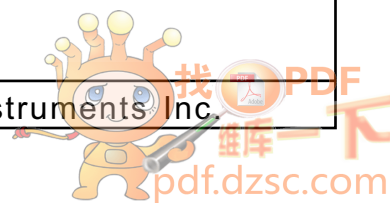

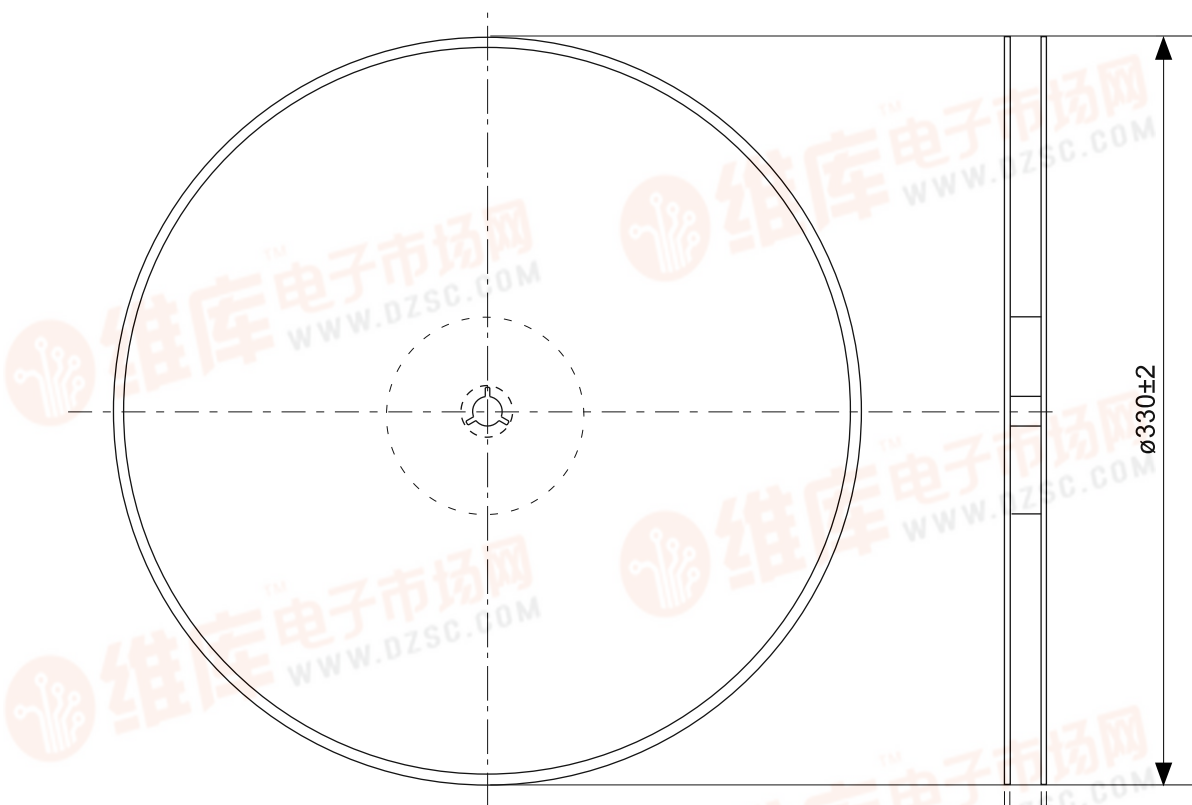

Enlarged drawing in the central part

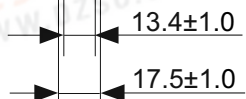
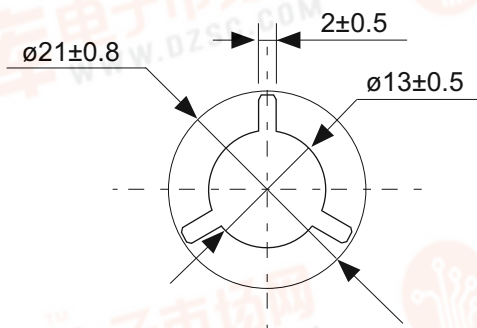

No. FT008-E-R-S1-1.0

TITLE	TSSOP8-E-Reel		
No.	FT008-E-R-S1-1.0		
SCALE		QTY.	4,000
UNIT	mm		

Seiko Instruments Inc.

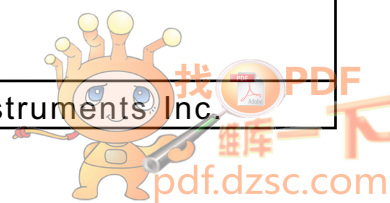



Seiko Instruments Inc.
www.sii-ic.com

- The information described herein is subject to change without notice.
- Seiko Instruments Inc. is not responsible for any problems caused by circuits or diagrams described herein whose related industrial properties, patents, or other rights belong to third parties. The application circuit examples explain typical applications of the products, and do not guarantee the success of any specific mass-production design.
- When the products described herein are regulated products subject to the Wassenaar Arrangement or other agreements, they may not be exported without authorization from the appropriate governmental authority.
- Use of the information described herein for other purposes and/or reproduction or copying without the express permission of Seiko Instruments Inc. is strictly prohibited.
- The products described herein cannot be used as part of any device or equipment affecting the human body, such as exercise equipment, medical equipment, security systems, gas equipment, or any apparatus installed in airplanes and other vehicles, without prior written permission of Seiko Instruments Inc.
- Although Seiko Instruments Inc. exerts the greatest possible effort to ensure high quality and reliability, the failure or malfunction of semiconductor products may occur. The user of these products should therefore give thorough consideration to safety design, including redundancy, fire-prevention measures, and malfunction prevention, to prevent any accidents, fires, or community damage that may ensue.

