

High Speed "Green Operation" LDO Voltage Regulators

GENERAL DESCRIPTION

GreenOperation-Compatible

The XC6207 series are precise, low noise, high speed, and low dropout regulators with green operation (GO) function. They are fabricated using Torex's CMOS process. Performance features of the series include high ripple rejection and low dropout voltage, and the series include a reference voltage source, an error amplifier, a current limiter, and a phase compensation circuit. Output voltage is selectable in 0.05V increments within a range of 1.2V~5.0V, using laser trimming technologies. The series' output stabilization capacitor (CL) is also compatible with low ESR ceramic capacitors. GO provides high speed operation, low power consumption and high efficiencies by automatically switching between a high speed mode (HS) and a power save mode (PS) depending upon the load current level. The switching point of the GO to the output current is being fixed inside the IC. The IC operates when the GO pin is low-level. When only high-speed operation is required, it can be fixed by inputting a high level signal to the GO pin, thus providing operating conditions with the most suitable level of supply current for the application. The CE function enables the output to be turned off resulting in greatly reduced power consumption. In this state, with the XC6207B series, the IC turns on the internal switch located between the VOUT and VSS pins. This short enables the electric charge at the output capacitor (CL) to be discharged via the internal auto-discharge resistance, and as a result the VOUT pin quickly returns to the VSS level. The constant current limit circuit and the current limiter's foldback circuit also operate as a short circuit protection for the output current limiter and the output pin.

APPLICATIONS

- Cellular phones
- Cordless phones,
- Wireless communication equipment
- Portable games
- Cameras, VCRs
- Portable AV equipment
- PDA's

FEATURES

- Maximum Output Current** : 300mA (Up to 380mA (TYP.))
- Dropout Voltage** : 40mV@ I_{OUT}=30mA
: 120mV@ I_{OUT}=100mA
- Operating Voltage Range** : 2.0V ~ 6.0V
- Output Voltage Setting Range** : 1.2V ~ 5.0V (0.05V increments)
- Accuracy** : ±2% (HS Mode: V_{OUT} >1.5V)
+ 2%, - 3% (PS Mode: V_{OUT} >1.5V)
±30mV (HS Mode: V_{OUT} 1.5V)
+30mV, - 45mV (HS Mode: V_{OUT} 1.5V)
- Low Power Consumption** : 5.5 μA (TYP.) (PS Mode)
50 μA (TYP.) (HS Mode)
- Stand-by Current** : Less than 0.1 μA
- High Ripple Rejection** : 70dB @ 1kHz
- Operating Temperature Range** : - 40 ~ 85
- Low ESR Capacitor** : Ceramic capacitor compatible
- CMOS**
- Low Output Noise**
- Green Operation (GO) Function**
- CL High-Speed Auto-Discharge (XC6207B)**
- Packages** : SOT-89-5, SOT-25, USP-6C
- Environmentally Friendly** : EU RoHS Compliant, Pb Free

TYPICAL APPLICATION CIRCUIT

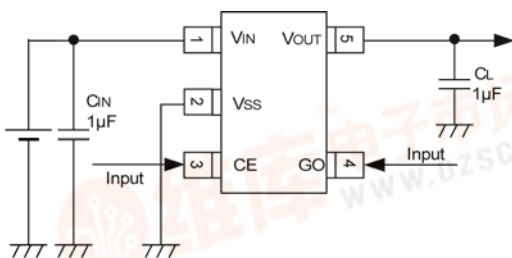

TYPICAL PERFORMANCE CHARACTERISTICS

Supply Current vs. Output Current

XC6207A182xx

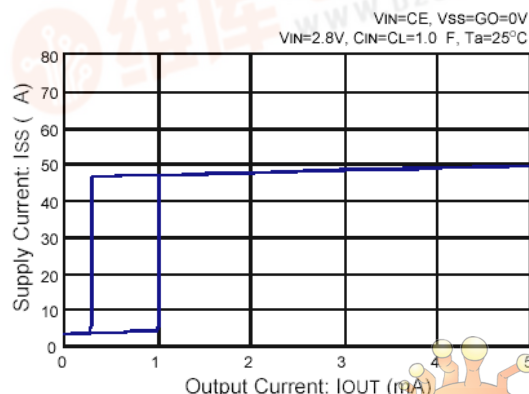

PIN CONFIGURATION

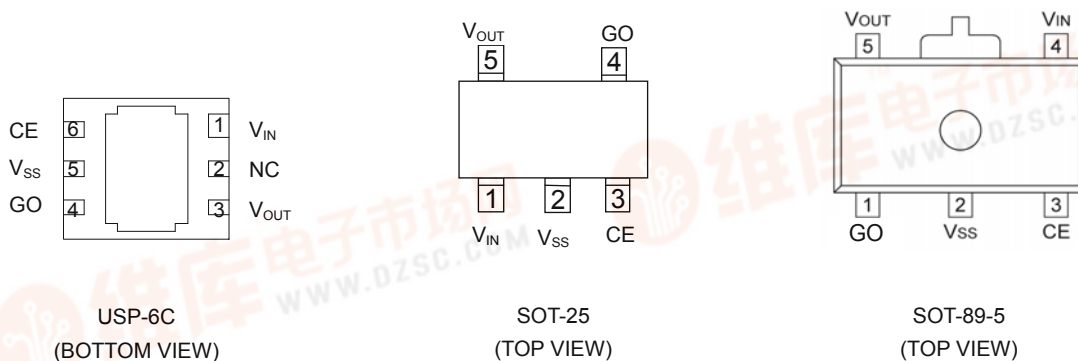

*The dissipation pad for the USP-6C package should be solder-plated in recommended mount pattern and metal masking so as to enhance mounting strength and heat release. If the pad needs to be connected to other pins, it should be connected to the V_{SS} (No. 5) pin.

PIN ASSIGNMENT

PIN NUMBER			PIN NAME	FUNCTIONS
USP-6C	SOT-25	SOT-89-5		
1	1	4	V_{IN}	Power Input
2	-	-	NC	No Connection
3	5	5	V_{OUT}	Output
4	4	1	GO	Green Operation Mode Switch
5	2	2	V_{SS}	Ground
6	3	3	CE	ON/OFF Control

FUNCTIONS CHART

CE pin

CE	FUNCTION
H	Operation
L	Stand-by

*For the XC6207B series, the output capacitor (C_L) is discharged via the internal auto-discharge resistance when the CE is at low level.

GO pin

GO	FUNCTION
H	High Speed Mode
L	Green Operation (HS/PS Mode Automatic Switching) $I_{GO} \leq I_{OUT}$: High Speed Mode $I_{GO} \geq I_{OUT}$: Power Save Mode

[查询XC6207供应商](#)

PRODUCT CLASSIFICATION

Ordering Information

XC6207 - (*)

DESIGNATOR	DESCRIPTION	SYMBOL	DESCRIPTION
	Type of Regulator	A	CE High Active, no resistor for fixing pin's electrical potential, no C _L discharge resistor
		B	CE High Active, no resistor for fixing pin's electrical potential, with C _L discharge resistor
	Output Voltage	12 ~ 50	ex.) V _{OUT(T)} = 3.0V = 3, = 0
	Output Accuracy	2	Output voltage 0.1V increments When HS mode, 1.2V < V _{OUT(T)} < 1.5V : Accuracy ± 30mV 1.5V < V _{OUT(T)} < 5.0V : Accuracy ± 2% When PS mode, 1.2V < V _{OUT(T)} < 1.5V : Accuracy ± 30mV or - 45mV 1.5V < V _{OUT(T)} < 5.0V : Accuracy ± 2% or - 3%
		A	Output voltage 0.05V increments When HS mode, 1.2V < V _{OUT(T)} < 1.5V : Accuracy ± 30mV 1.5V < V _{OUT(T)} < 5.0V : Accuracy ± 2% When PS mode, 1.2V < V _{OUT(T)} < 1.5V : Accuracy ± 30mV or - 45mV 1.5V < V _{OUT(T)} < 5.0V : Accuracy ± 2% or - 3%
	Packages Taping Type (*)	ER	USP-6C
		ER-G	USP-6C (Halogen & Antimony free)
		MR	SOT-25
		MR-G	SOT-25 (Halogen & Antimony free)
		PR	SOT-89-5

(*) The "-G" suffix indicates that the products are Halogen and Antimony free as well as being fully RoHS compliant.

(*) The device orientation is fixed in its embossed tape pocket. For reverse orientation, please contact your local Torex sales office or representative. (Standard orientation: R- , Reverse orientation: L-)

BLOCK DIAGRAMS

XC6207A Series

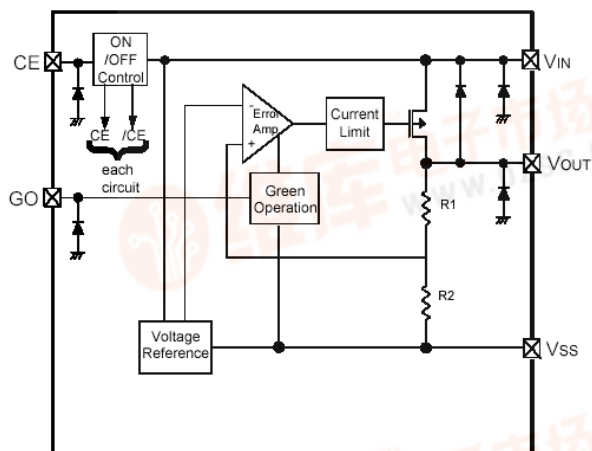

XC6207B Series

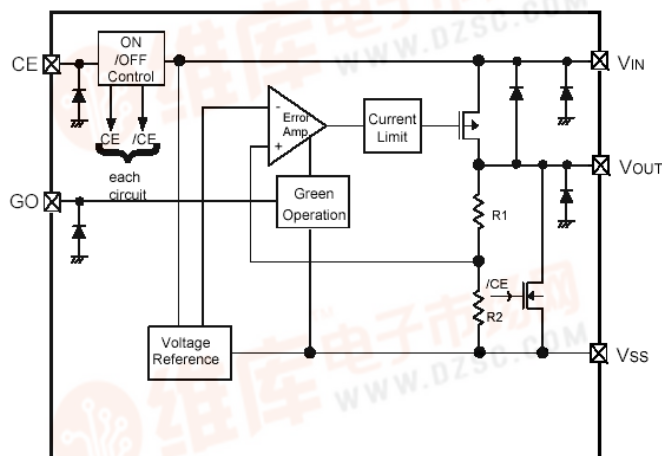

*Diodes inside the circuit are ESD protection diodes and parasitic diodes.

ABSOLUTE MAXIMUM RATINGS

Ta=25

PARAMETER	SYMBOL	RATINGS	UNITS
Input Voltage	V _{IN}	- 0.3 ~ 7.0	V
Output Current	I _{OUT}	500*	mA
Output Voltage	V _{OUT}	V _{SS} - 0.3 ~ V _{IN} + 0.3	V
CE Input Voltage	V _{CE}	V _{SS} - 0.3 ~ 7.0	V
GO Input Voltage	V _{GO}	V _{SS} - 0.3 ~ 7.0	V
Power Dissipation	SOT-89-5	500	mW
	SOT-25	250	
	USP-6C	100	
Operational Temperature Range	T _{opr}	- 40 ~ + 85	
Storage Temperature Range	T _{stg}	- 55 ~ +125	

* I_{OUT}=Pd / (V_{IN}-V_{OUT})

ELECTRICAL CHARACTERISTICS

XC6207A/B series

Ta=25

PARAMETER	SYMBOL	CONDITIONS	MIN.	TYP.	MAX.	UNITS	CIRCUIT
Output Voltage	V _{OUT(E)} (*3)	V _{GO} =V _{IN} , V _C E=V _{IN} , I _{OUT} =10mA: High Speed (HS) mode	(*)	E-0	(*)	V	
		V _{GO} =V _{SS} , V _C E=V _{IN} , I _{OUT} =0.1mA: Power Save (PS) mode	(*)	E-1	(*)		
Maximum Output Current	I _{OUTMAX}	V _C E=V _{IN}	300	-	-	mA	
Load Regulation	ΔV _{OUT}	V _{GO} =V _{IN} (HS mode), V _C E=V _{IN} , 1mA I _{OUT} 100mA	-	15	60	mV	
Dropout Voltage (*4)	V _{dif1}	V _{GO} =V _{IN} , (HS mode), V _C E=V _{IN} , I _{OUT} =30mA	E-2			mV	
	V _{dif2}	V _{GO} =V _{IN} (HS mode), V _C E=V _{IN} , I _{OUT} =100mA	E-3				
Supply Current 1	I _{SS1}	V _{GO} =V _{IN} (HS mode), V _{IN} =V _C E=6.0V, No load	35	50	80	μA	
Supply Current 2	I _{SS2}	V _{GO} =V _{SS} (PS mode), V _{IN} =V _C E=6.0V, No load	-	5.5	8.0	μA	
Stand-by Current	I _{STBY}	V _{IN} =6.0V, V _C E=V _{SS}	-	0	0.1	μA	
Line Regulation 1.2V V _{OUT(T)} < 4.5V	ΔV _{OUT} ΔV _{IN} · V _{OUT}	V _{GO} =V _{IN} (HS mode), V _{OUT(T)} +1.0V ≤ V _{IN} ≤ 6.0V, V _C E=V _{IN} , I _{OUT} =30mA	-	0.01	0.20	%V	
Line Regulation 4.5V V _{OUT(T)} 5.0V		V _{GO} =V _{IN} (HS mode), 5.5V ≤ V _{IN} ≤ 6.0V, V _C E=V _{IN} , I _{OUT} =30mA					
Input Voltage	V _{IN}	-	2.0	-	6.0	V	
Output Voltage Temperature Characteristics	ΔV _{OUT} ΔTa · V _{OUT}	V _{GO} =V _{IN} (HS mode), -40 ≤ Ta ≤ 85, V _C E=V _{IN} , I _{OUT} =30mA	-	± 100	-	ppm/	
Ripple Rejection Rate 1.2V V _{OUT(T)} 1.25V	PSRR	V _{GO} =V _{IN} (HS mode), V _C E=V _{IN} , I _{OUT} =30mA, V _{IN} =2.25V _{DC} +0.5V _{p-pAC} , f=1kHz	-	70	-	dB	
Ripple Rejection Rate 1.25V < V _{OUT(T)} < 4.75V		V _{GO} =V _{IN} (HS mode), V _C E=V _{IN} , I _{OUT} =30mA, V _{IN} ={V _{OUT(T)} +1.0V}V _{DC} +0.5V _{p-pAC} , f=1kHz					
Ripple Rejection Rate 4.75V V _{OUT(T)} 5.0V		V _{GO} =V _{IN} (HS mode), V _C E=V _{IN} , I _{OUT} =30mA, V _{IN} =5.75V _{DC} +0.5V _{p-pAC} , f=1kHz					
Limit Current	I _{lim}	V _{GO} =V _{IN} (HS mode), V _C E=V _{IN}	300	380	-	mA	
Short Current	I _{short}	V _{GO} =V _{IN} (HS mode), V _C E=V _{IN} V _{OUT} is short-circuited at the V _{SS} level.	-	50	-	mA	
PS Switching Current	I _{GOR}	V _C E=V _{IN} , V _{GO} =V _{SS} , (HS/PS automatic switching) I _{OUT} : heavy to light load	0.3	-	-	mA	
HS Switching Current	I _{GO}	V _C E=V _{IN} , V _{GO} =V _{SS} , (HS/PS automatic switching) I _{OUT} : light to heavy load	-	-	2.0	mA	

ELECTRICAL CHARACTERISTICS (Continued)

XC6207A/B series (Continued)

Ta=25

PARAMETER	SYMBOL	CONDITIONS	MIN.	TYP.	MAX.	UNITS	CIRCUIT
Switching Current Hysteresis Range	IGOhys	IGOhys=IGO- IGOR	-	1.0	-	mA	
PS Switching Delay Time	T _{DPS}	VCE=VIN, VGO=VSS, (HS/PS automatic switching) Time until HS mode switches to PS mode by IGOR.	-	-	900	μs	
CE High Level Voltage	VCEH	VGO=VIN, no load Voltage to start operation by applying voltage to the CE.	1.6	-	-	V	
CE Low Level Voltage	VCEL	VGO=VIN, no load Voltage to become the stand-by mode by applying voltage to the CE.	-	-	0.25	V	
GO High Level Voltage ^(*7)	VGOH	VCE=VIN, no load Voltage to become HS mode by applying voltage to the GO.	1.6	-	-	V	
GO Low Level Voltage ^(*7)	VGOL	VCE=VIN, no load Voltage to become HS/PS automatic switching mode by applying voltage to the GO.	-	-	0.25	V	
CE High Level Current	ICEH	VCE=VIN, VGO=VIN	- 0.1	-	0.1	μA	
CE Low Level Current	ICEL	VCE=VSS, VGO=VIN	- 0.1	-	0.1	μA	
GO High Level Current	IGOH	VGO =VIN, VCE=VIN	- 0.1	-	0.1	μA	
GO Low Level Current	IGOL	VGO=VSS, VCE=VIN	- 0.1	-	0.1	μA	
CL Auto-Discharge Resistance ^(*8)	R _{dischg}	VIN=6.0V, VOUT=6.0V, VCE=VGO=VSS	-	470	-		

NOTE:

- * 1: Unless otherwise stated, VIN=VOUT(T) + 1.0V.
- * 2: VOUT(T) = Specified output voltage
- * 3: VOUT(E) = Effective output voltage
(I.e. the output voltage when an amply stabilized "VOUT(T) + 1.0V" is provided at the VIN pin while maintaining a certain IOUT value.)
High Speed (HS) mode: The voltage of VGOH or more is input to the GO pin, or the voltage of VGOL or less is input to the GO pin when the output current is IGO or more.
Power Save (PS) mode: The voltage of VGOL or less is input to the GO pin when the output current is IGOR or less.
- * 4: $V_{dif} = \{V_{IN1}^{(6)} - V_{OUT1}^{(5)}\}$
- * 5: VOUT1=A voltage equal to 98% of the output voltage whenever an amply stabilized IOUT {VOUT(T)+1.0V} is input in the HS mode.
- * 6: VIN1=The input voltage when VOUT1 appears as Input Voltage is gradually decreased.
- * 7: With the GO pin input voltage, the fixed HS mode or Green Operation (GO) is selectable.
- * 8: For the XC6207B series only. The XC6207A series discharges by resistors R1 and R2 only as shown in the block diagrams.
- * 9: The rated value of the output voltage when VOUT(T) = 1.5V is shown below.
HS mode : VOUT(T) -30mV VOUT(E) VOUT(T) +30mV
PS mode : VOUT(T) -45mV VOUT(E) VOUT(T) +30mV
- *10: Recommended conditions for CIN and CL
1.2V VOUT(T) < 1.8V: CIN=1.0 μ F, CL=4.7 μ F (ceramic cap.)
1.8V VOUT(T) < 2.5V: CIN=1.0 μ F, CL=1.0 μ F (ceramic cap.)
2.5V VOUT(T) 5.0V: CIN=2.2 μ F, CL=1.0 μ F (ceramic cap.)

ELECTRICAL CHARACTERISTICS (Continued)

DROPOUT VOLTAGE CHART

SETTING OUTPUT VOLTAGE (V)	E-0			E-1			E-2		E-3	
	OUTPUT VOLTAGE (HS MODE) (V)			OUTPUT VOLTAGE (PS MODE) (V)			DROPOUT VOLTAGE 1 I _{OUT} =30mA (mV)		DROPOUT VOLTAGE 2 I _{OUT} =100mA (mV)	
	V _{OUT(E)}			V _{OUT(E)}			V _{dif1}		V _{dif2}	
V _{OUT(T)}	MIN.	TYP.	MAX.	MIN.	TYP.	MAX.	TYP.	MAX.	TYP.	MAX.
1.20	1.170	1.20	1.230	1.1550	1.20	1.230	800	850	810	860
1.25	1.220	1.25	1.280	1.2050	1.25	1.280				
1.30	1.270	1.30	1.330	1.2550	1.30	1.330	700	750	710	760
1.35	1.320	1.35	1.380	1.3050	1.35	1.380				
1.40	1.370	1.40	1.430	1.3550	1.40	1.430	600	650	610	660
1.45	1.420	1.45	1.480	1.4050	1.45	1.480				
1.50	1.470	1.50	1.530	1.4550	1.50	1.530	500	550	510	560
1.55	1.519	1.55	1.581	1.5035	1.55	1.581				
1.60	1.568	1.60	1.632	1.5520	1.60	1.632	400	450	410	460
1.65	1.617	1.65	1.683	1.6005	1.65	1.683				
1.70	1.666	1.70	1.734	1.6490	1.70	1.734	300	350	310	360
1.75	1.715	1.75	1.785	1.6975	1.75	1.785				
1.80	1.764	1.80	1.836	1.7460	1.80	1.836	200	250	210	260
1.85	1.813	1.85	1.887	1.7945	1.85	1.887				
1.90	1.862	1.90	1.938	1.8430	1.90	1.938	100	150	200	250
1.95	1.911	1.95	1.989	1.8915	1.95	1.989				
2.00	1.960	2.00	2.040	1.9400	2.00	2.040	60	90	180	245
2.05	2.009	2.05	2.091	1.9885	2.05	2.091				
2.10	2.058	2.10	2.142	2.0370	2.10	2.142				
2.15	2.107	2.15	2.193	2.0855	2.15	2.193				
2.20	2.156	2.20	2.244	2.1340	2.20	2.244				
2.25	2.205	2.25	2.295	2.1825	2.25	2.295				
2.30	2.254	2.30	2.346	2.2310	2.30	2.346				
2.35	2.303	2.35	2.397	2.2795	2.35	2.397				
2.40	2.352	2.40	2.448	2.3280	2.40	2.448				
2.45	2.401	2.45	2.499	2.3765	2.45	2.499				
2.50	2.450	2.50	2.550	2.4250	2.50	2.550	50	70	150	220
2.55	2.499	2.55	2.601	2.4735	2.55	2.601				
2.60	2.548	2.60	2.652	2.5220	2.60	2.652				
2.65	2.597	2.65	2.703	2.5705	2.65	2.703				
2.70	2.646	2.70	2.754	2.6190	2.70	2.754				
2.75	2.695	2.75	2.805	2.6675	2.75	2.805				
2.80	2.744	2.80	2.856	2.7160	2.80	2.856				
2.85	2.793	2.85	2.907	2.7645	2.85	2.907				
2.90	2.842	2.90	2.958	2.8130	2.90	2.958				
2.95	2.891	2.95	3.009	2.8615	2.95	3.009				
3.00	2.940	3.00	3.060	2.9100	3.00	3.060	40	65	120	190
3.05	2.989	3.05	3.111	2.9585	3.05	3.111				
3.10	3.038	3.10	3.162	3.0070	3.10	3.162				
3.15	3.087	3.15	3.213	3.0555	3.15	3.213				
3.20	3.136	3.20	3.264	3.1040	3.20	3.264				
3.25	3.185	3.25	3.315	3.1525	3.25	3.315				
3.30	3.234	3.30	3.366	3.2010	3.30	3.366				
3.35	3.283	3.35	3.417	3.2495	3.35	3.417				
3.40	3.332	3.40	3.468	3.2980	3.40	3.468				

ELECTRICAL CHARACTERISTICS (Continued)

DROPOUT VOLTAGE CHART (Continued)

SETTING OUTPUT VOLTAGE (V)	E-0			E-1			E-2		E-3	
	OUTPUT VOLTAGE (HS MODE) (V)			OUTPUT VOLTAGE (PS MODE) (V)			DROPOUT VOLTAGE 1 I _{OUT} =30mA (mV)		DROPOUT VOLTAGE 2 I _{OUT} =100mA (mV)	
V _{OUT(T)}	V _{OUT(E)}			V _{OUT(E)}			V _{dif1}		V _{dif2}	
	MIN.	TYP.	MAX.	MIN.	TYP.	MAX.	TYP.	MAX.	TYP.	MAX.
3.45	3.381	3.45	3.519	3.3465	3.45	3.519	40	65	120	190
3.50	3.430	3.50	3.570	3.3950	3.50	3.570				
3.55	3.479	3.55	3.621	3.4435	3.55	3.621				
3.60	3.528	3.60	3.672	3.4920	3.60	3.672				
3.65	3.577	3.65	3.723	3.5405	3.65	3.723				
3.70	3.626	3.70	3.774	3.5890	3.70	3.774				
3.75	3.675	3.75	3.825	3.6375	3.75	3.825				
3.80	3.724	3.80	3.876	3.6860	3.80	3.876				
3.85	3.773	3.85	3.927	3.7345	3.85	3.927				
3.90	3.822	3.90	3.978	3.7830	3.90	3.978				
3.95	3.871	3.95	4.029	3.8315	3.95	4.029				
4.00	3.920	4.00	4.080	3.8800	4.00	4.080				
4.05	3.969	4.05	4.131	3.9285	4.05	4.131				
4.10	4.018	4.10	4.182	3.9770	4.10	4.182				
4.15	4.067	4.15	4.233	4.0255	4.15	4.233				
4.20	4.116	4.20	4.284	4.0740	4.20	4.284				
4.25	4.165	4.25	4.335	4.1225	4.25	4.335				
4.30	4.214	4.30	4.386	4.1710	4.30	4.386				
4.35	4.263	4.35	4.437	4.2195	4.35	4.437				
4.40	4.312	4.40	4.488	4.2680	4.40	4.488				
4.45	4.361	4.45	4.539	4.3165	4.45	4.539				
4.50	4.410	4.50	4.590	4.3650	4.50	4.590				
4.55	4.459	4.55	4.641	4.4135	4.55	4.641				
4.60	4.508	4.60	4.692	4.4620	4.60	4.692				
4.65	4.557	4.65	4.743	4.5105	4.65	4.743				
4.70	4.606	4.70	4.794	4.5590	4.70	4.794				
4.75	4.655	4.75	4.845	4.6075	4.75	4.845				
4.80	4.704	4.80	4.896	4.6560	4.80	4.896				
4.85	4.753	4.85	4.947	4.7045	4.85	4.947				
4.90	4.802	4.90	4.998	4.7530	4.90	4.998				
4.95	4.851	4.95	5.049	4.8015	4.95	5.049				
5.00	4.900	5.00	5.100	4.8500	5.00	5.100				

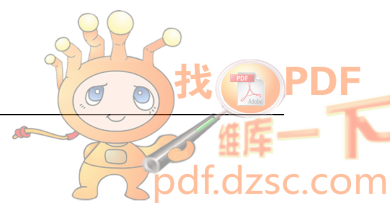

OPERATIONAL EXPLANATION

<Output Voltage Control>

The voltage divided by resistors R1 & R2 is compared with the internal reference voltage by the error amplifier. The P-channel MOSFET, which is connected to the V_{OUT} pin, is then driven by the subsequent output signal. The output voltage at the V_{OUT} pin is controlled & stabilized by a system of negative feedback. The current limit circuit and short protect circuit operate in relation to the level of output current. The GO function monitors the output current and switches a supply current to two values according to the level of output current. Further, the IC's internal circuitry can be shutdown via the CE pin's signal.

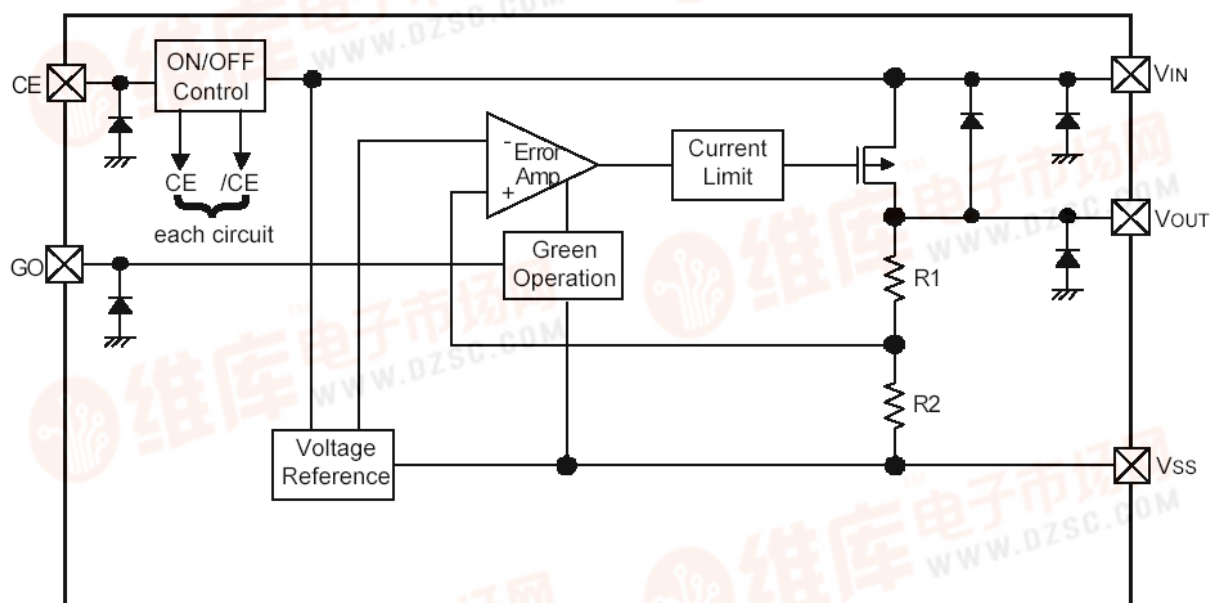

<Green Operation>

XC6207 series can be set as a fixed high-speed mode or a green operation (GO) mode via a signal to the green operation (GO) pin. Under the condition that the output current becomes I_{GOR} or less, the IC operates in the high speed mode (HS) when the GO pin is at high level and the IC operates in the power save (PS) mode when the GO pin is at low level. The GO mode enables the IC to switch automatically the supply current to the high speed (HS) mode or the power save (PS) mode according to the level of output current. While having both high-speed operation and low supply current state, the XC6207 series can acquire high efficiency. At the HS/PS automatic switching mode (GO mode), the switching point of the HS mode and the PS mode is being fixed inside the IC. When the output current becomes I_{GOR} 0.3mA (TYP.) or below, the mode changes automatically to the PS mode after the delay time of hundreds μ s, and it can reduce supply current in light load. For applications, most of portable equipment control the system current, which is the output current to the IC, according to the system condition. Furthermore, the high-speed operation might be required. In such a case, the mode will automatically switch to the HS mode at the automatic switching mode (GO mode), when the output current becomes I_{GO} or more. In the HS mode, the response of the output voltage during the output current fluctuation is better than the PS mode. Automatic switching PS mode to HS mode causes the switching delay time of tens of μ s, the output voltage drops more than in the fixed HS mode. If the GO pin voltage is at high level (tens of μ s (τ) before the output current fluctuation occurs) and the IC is used in the HS mode, the output current fluctuation will be suppressed to as low as the fixed HS mode. (cf. the following item: Load Transient Response by Switching Mode with GO pin.)

The output current at the HS/PS mode should be adjusted to 2.0mA or more / 0.3mA or less respectively when the IC is used in the HS/PS automatic switching mode (GO mode).

It is suggested that you use this IC with either a V_{IN} voltage or a V_{SS} voltage input at the GO pin. If this IC is used with the correct specifications for the GO pin, the IC will operate normally. However, supply current may increase as a result of through current in the IC's internal circuitry when medium voltage is input.

OPERATIONAL EXPLANATION (Continued)

<Green Operation> (Continued)

Load Transient Response by GO mode

GO mode (GO pin voltage: Low)

Output Current: I_{OUT}=0.1mA 100mA

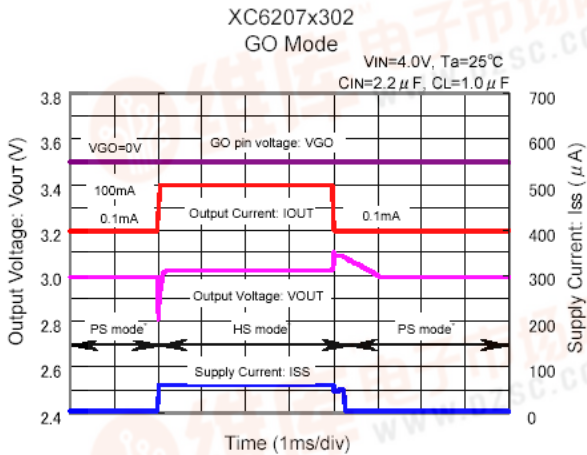

Fixed high speed mode via GO pin signal (GO pin voltage: Low to High)

Output Current: I_{OUT}=0.1mA 100mA

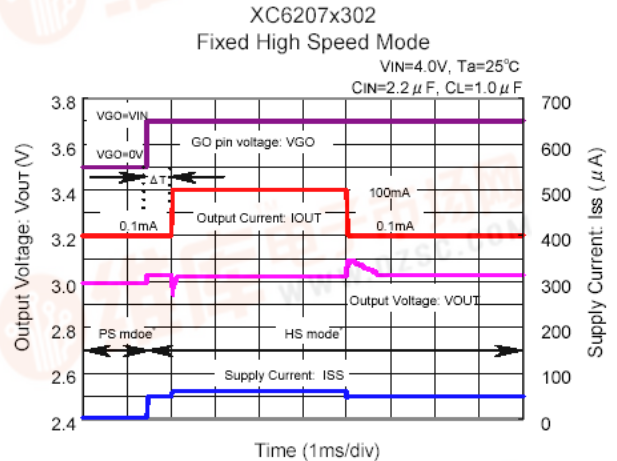

*Note: Input a "H" level signal to the GO pin before the output current fluctuation (ΔT) occurs.

GO mode (GO pin voltage: Low)

Output Current: I_{OUT}=0.1mA 5mA

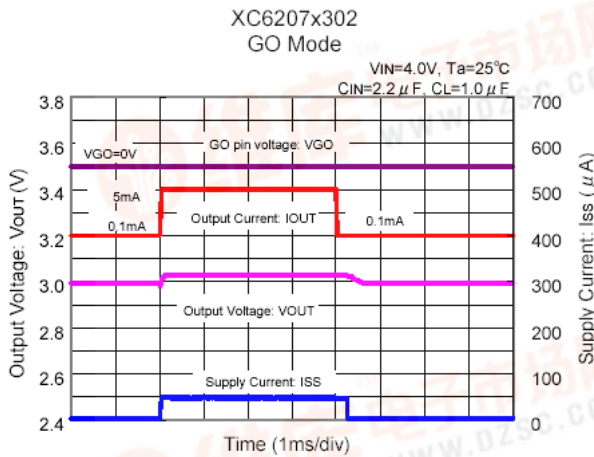

Fixed high speed mode via GO pin signal (GO pin voltage: Low to High)

Output Current: I_{OUT}=0.1mA 5mA

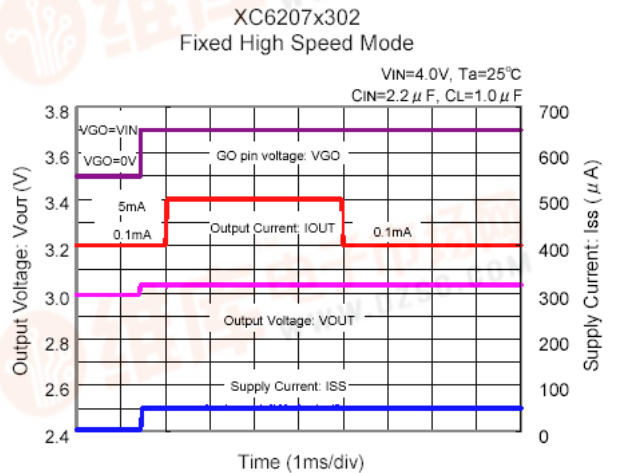

<Low ESR capacitor>

With the XC6207 series, a stable output voltage is achievable even if used with low ESR capacitors, as a phase compensation circuit is built-in. In order to ensure the effectiveness of the phase compensation, we suggest that an output capacitor (CL) is connected as close as possible to the output pin (V_{OUT}) and the V_{SS} pin. Please use an output capacitor with a capacitance value of at least 1 μ F when the setting output voltage (V_{OUT(T)}) is less than or equal to 1.8V. Also, when the setting output voltage (V_{OUT(T)}) is less than or equal to 2.5V, please connect an input capacitor (C_{IN}) of 2.2 μ F between the V_{IN} pin and the V_{SS} pin in order to ensure a stable power input. The capacitor is possible to decrease depends on bias and temperature. Therefore the phase compensation cannot be ensured effectiveness. Stable phase compensation may not be ensured if the capacitor runs out capacitance when depending on bias and temperature. In case the capacitor depends on the bias and temperature, please make sure the capacitor can ensure the actual capacitance.

<Recommended conditions of C_{IN} and C_L>

SETTING VOLTAGE	C _{IN} (μ F)	C _L (μ F)
More than 1.2V ~ Under 1.8V	1.0	4.7
More than 1.8V ~ Under 2.5V	1.0	1.0
More than 2.5V ~ Less than 5.0V	2.2	1.0

OPERATIONAL EXPLANATION (Continued)

<CL Auto-Discharge Function>

XC6207B series can quickly discharge the electric charge at the output capacitor (CL), when a low signal to the CE pin, which enables a whole IC circuit put into OFF state, is inputted via the N-channel transistor located between the VOUT pin and the Vss pin (cf. BLOCK DIAGRAM). In this state, the application is protected from a glitch operation caused by the electric charge at the output capacitor (CL). The CL auto-discharge resistance at this time depends on the input voltage. Moreover, discharge time of the output capacitor (CL) is set by the CL auto-discharge resistance (R) and the output capacitor (CL). By setting time constant of a CL auto-discharge resistance value [R] and an output capacitor value (CL) as $\tau = C \times R$, the output voltage after discharge via the N channel transistor is calculated by the following formulas.

$$V = V_{OUT} \times e^{-t/R}, \text{ or } t = R \times \ln(V_{OUT} / V)$$

(V : Output voltage after discharge, $V_{OUT(E)}$: Output voltage, t: Discharge time,
 : CL auto-discharge resistance R × Output capacitor (CL) value C)

Ta=25°C

INPUT VOLTAGE	CL AUTO-DISCHARGE RESISTANCE
2.0V	750 (TYP.)
3.0V	550 (TYP.)
4.0V	500 (TYP.)
5.0V	480 (TYP.)
6.0V	470 (TYP.)

(ex.) When input voltage: 4.0V, CL auto-discharge resistance: 500 (TYP.); output capacitor (CL): 10 μF, V_{OUT} :3.0V, CE voltage=Changing from 4.0V to 0V (The CE pin L level signal)

- 1 (500 μs) after CE OFF signal is inputted, $V_{OUT(E)}$ becomes: $3.0V \times 0.368 = \text{approx. } 1.104V$
- 2 (1000 μs) after CE OFF signal is inputted, $V_{OUT(E)}$ becomes: $3.0V \times 0.135 = \text{approx. } 0.405V$
- 3 (1500 μs) after CE OFF signal is inputted, $V_{OUT(E)}$ becomes: $3.0V \times 0.050 = \text{approx. } 0.150V$
- 4 (2000 μs) after CE OFF signal is inputted, $V_{OUT(E)}$ becomes: $3.0V \times 0.018 = \text{approx. } 0.055V$

OUTPUT VOLTAGE DISCHARGE CHARACTERISTICS

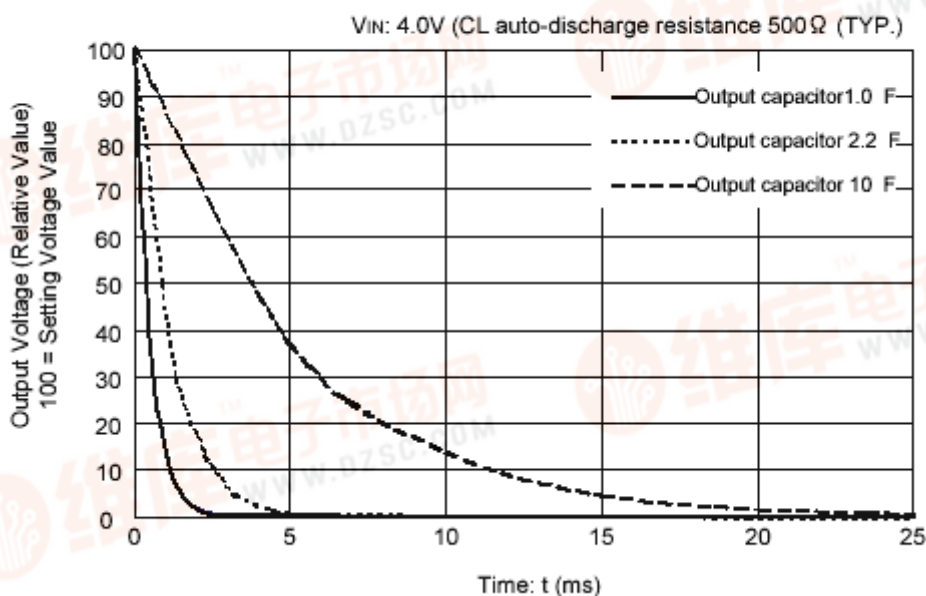

OPERATIONAL EXPLANATION (Continued)

<Current Limiter, Short-Circuit Protection>

The XC6207 series includes a combination of a fixed current limiter circuit & a foldback circuit, which aid the operations of the current limiter and circuit protection. When the load current reaches the current limit level, the fixed current limiter circuit operates and output voltage drops. As a result of this drop in output voltage, the foldback circuit operates and output voltage drops further and output current decreases. When the output pin is shorted, a current of about 50mA flows.

<The CE Pin>

The IC's internal circuitry can be shutdown via the signal from the CE pin with the XC6207 series. In shutdown mode, output at the V_{OUT} pin will be pulled down to the V_{SS} level via R₁ & R₂. However, as for the XC6207B series, the CL auto-discharge resistor is connected in parallel to R₁ and R₂ while the power supply is applied to the V_{IN} pin. Therefore, time until the V_{OUT} pin reaches the V_{SS} level becomes short. We suggest that you use this IC with either a V_{IN} voltage or a V_{SS} voltage input at the CE pin. If this IC is used with the correct specifications for the CE pin, the IC will operate normally. However, supply current may increase as a result of through current in the IC's internal circuitry when medium voltage is input.

NOTES ON USE

1. Please use this IC within the stated absolute maximum ratings. The IC is liable to malfunction should the ratings be exceeded.
2. Where wiring impedance is high, operations may become unstable due to noise and/or phase lag depending on output current. Please strengthen V_{IN} and V_{SS} wiring in particular.
3. Please wire the input capacitor (C_{IN}) and the output capacitor (C_L) as close to the IC as possible.

TEST CIRCUITS

Circuit 1 Output Voltage, Input Operating Voltage, Dropout Voltage, Line Regulation, Load Regulation, Limit Current, Short Current

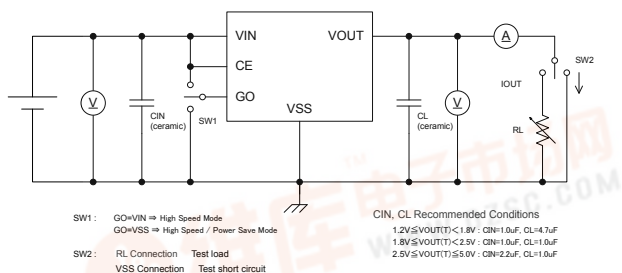

Circuit 2 Supply Current, Standby Current

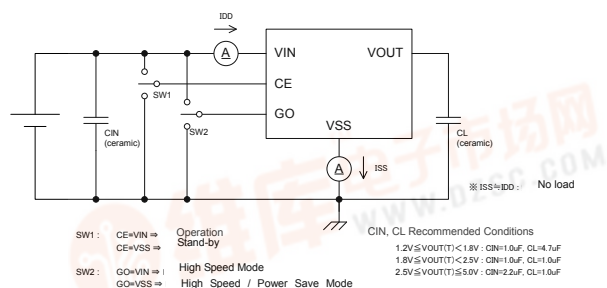

Circuit 3 Ripple Rejection Rate

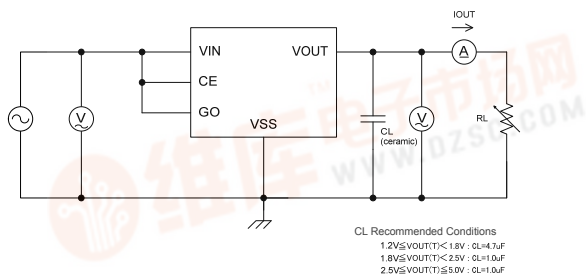

Circuit 4 CE/GO, High & Low Level Voltage

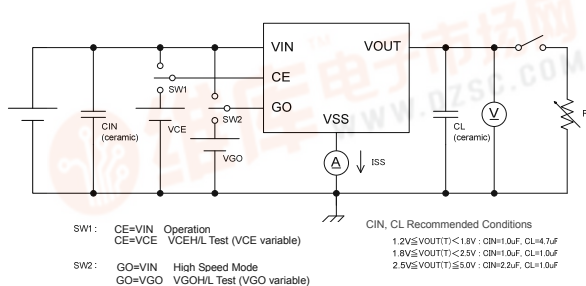

Circuit 5 CE/GO, High & Low Level Current

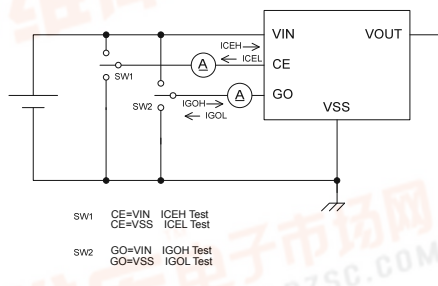

Circuit 6 HS/PS Switching Current, PS Switching Delay Time

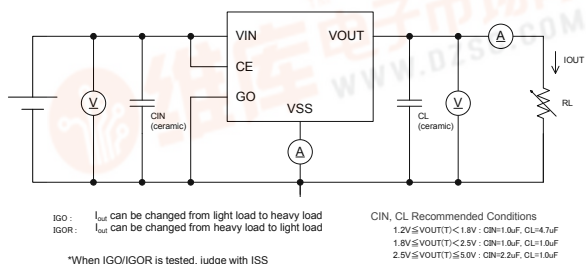

Circuit 7 CL Auto-Discharge Resistance Current

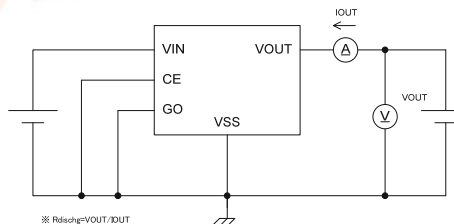

Note: For the capacity of the CIN and the CL, the recommended capacity depending on the setting voltage should be used.

TYPICAL PERFORMANCE CHARACTERISTICS

(1) Output Voltage vs. Input Voltage

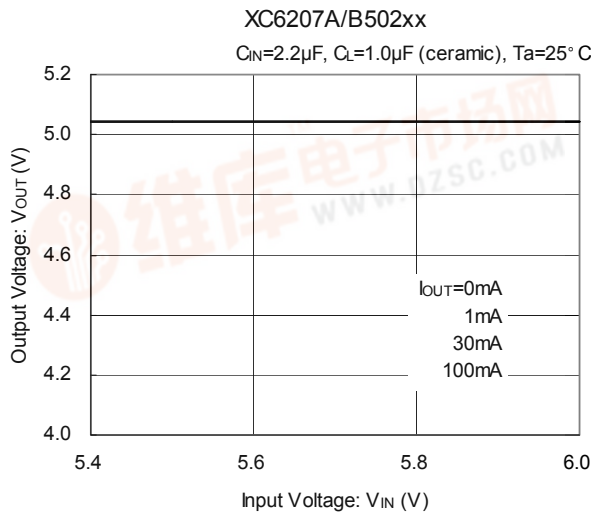
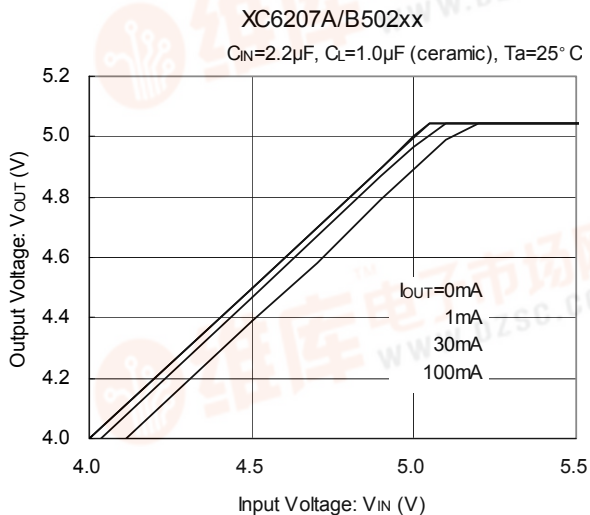
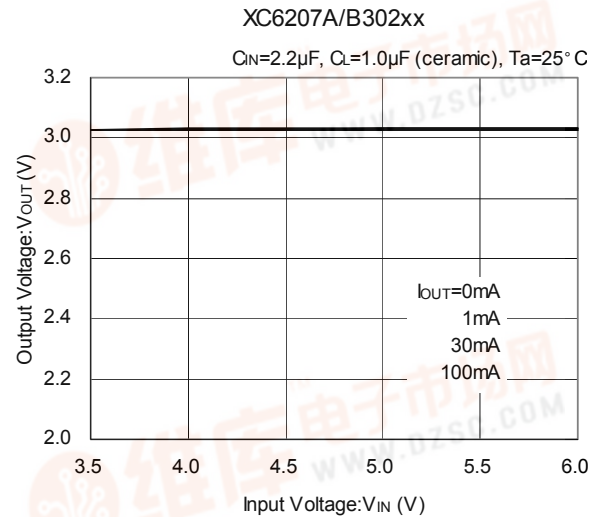
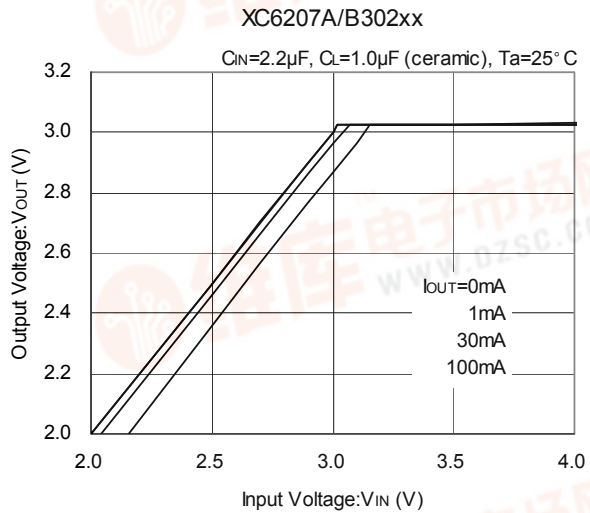
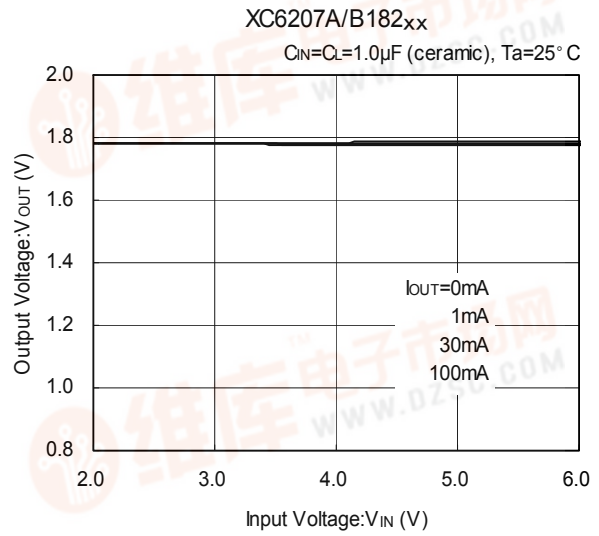
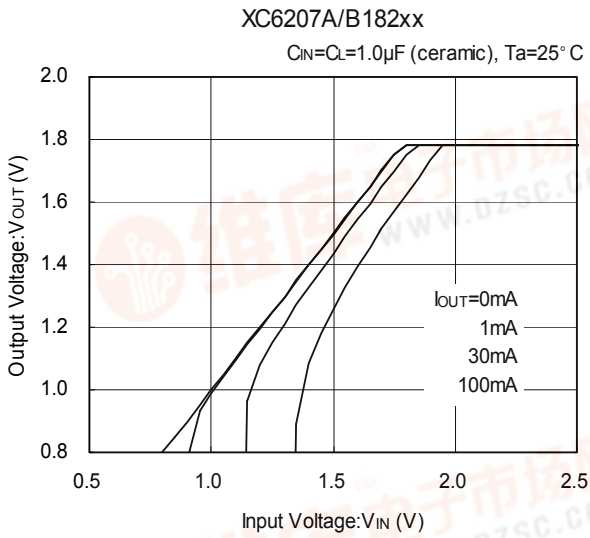

TYPICAL PERFORMANCE CHARACTERISTICS (Continued)

(2) Dropout Voltage vs. Output Current

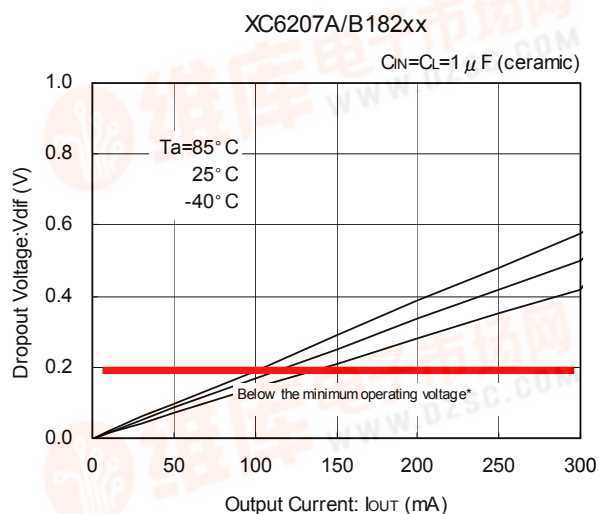
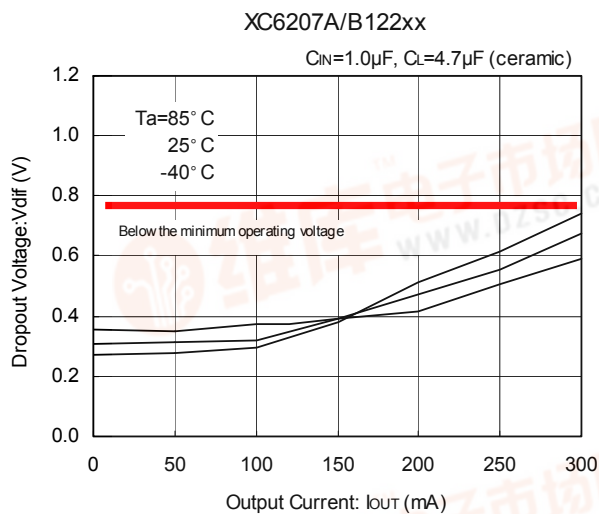

*The characteristic when V_{dif} is lower than 0.2V is the reference characteristic below the minimum operating voltage.

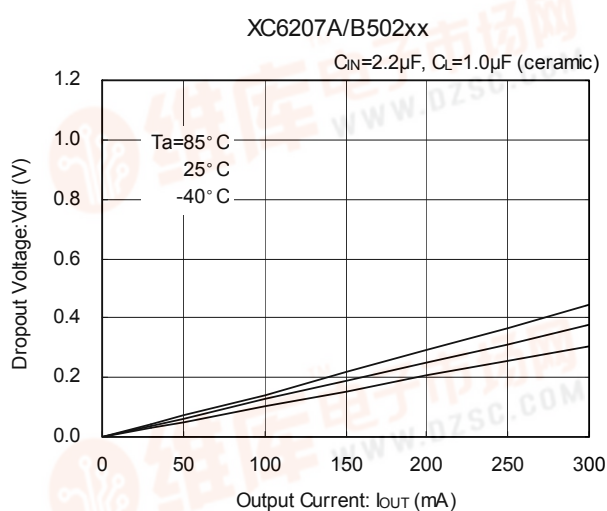
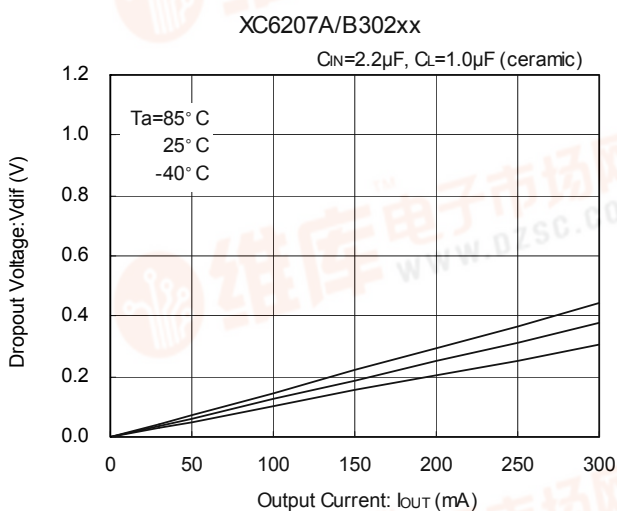

(3) Supply Current vs. Input Voltage

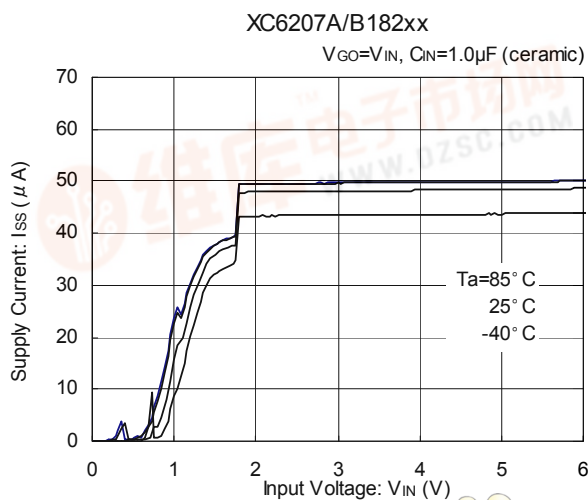
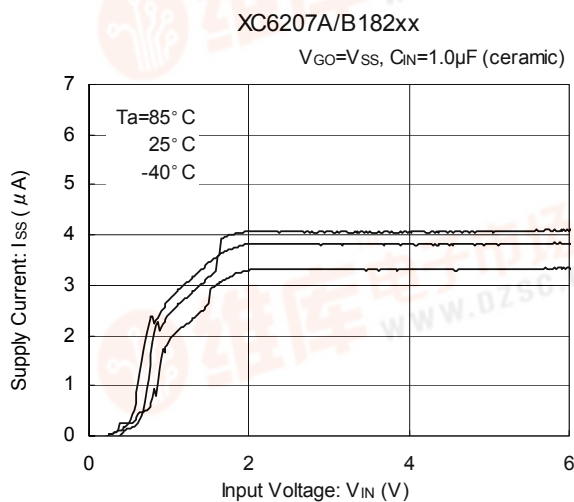

TYPICAL PERFORMANCE CHARACTERISTICS (Continued)

(3) Supply Current vs. Input Voltage (Continued)

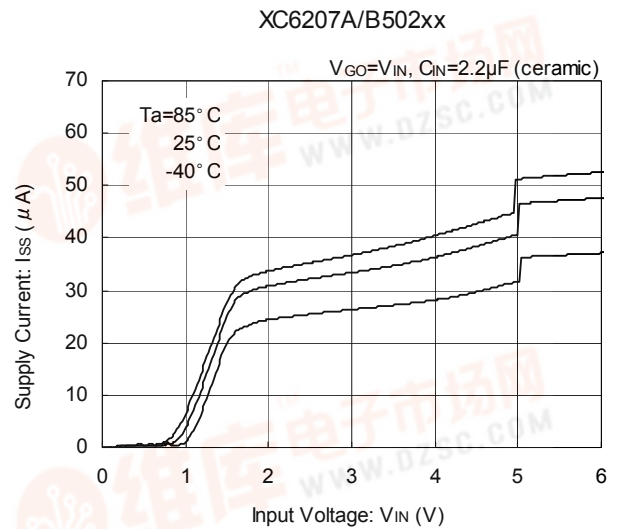
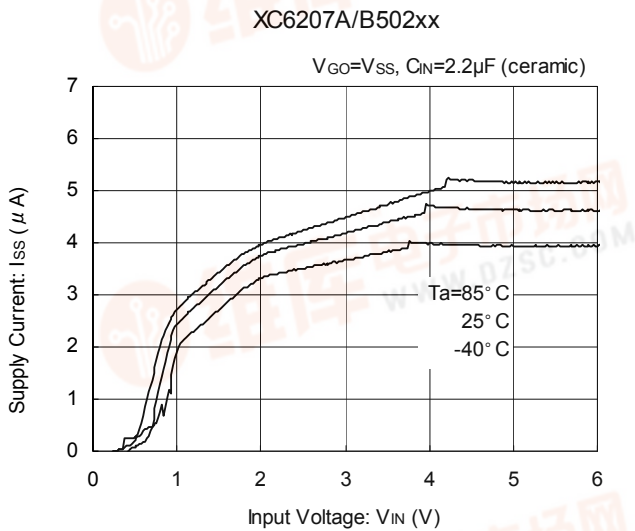
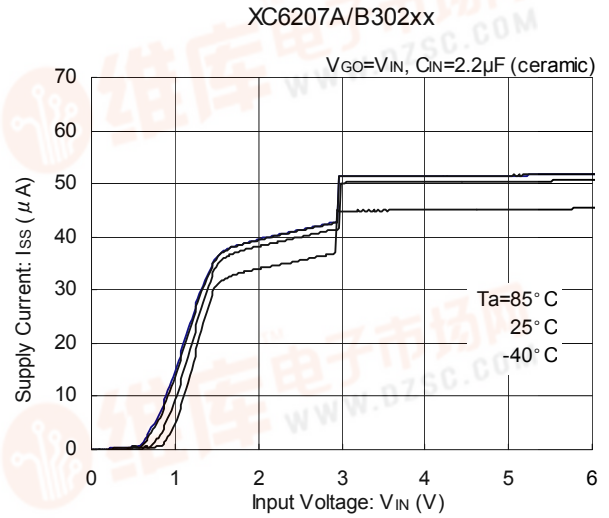
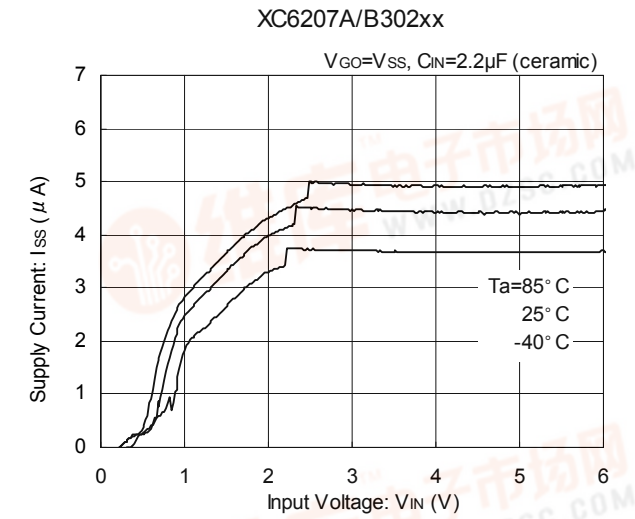

(4) Current Limit

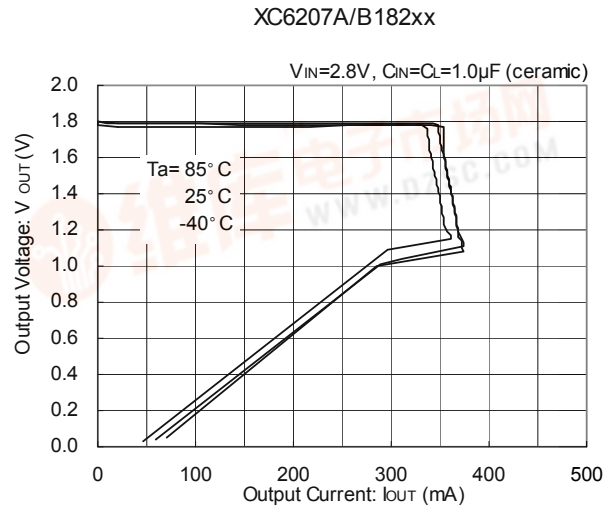
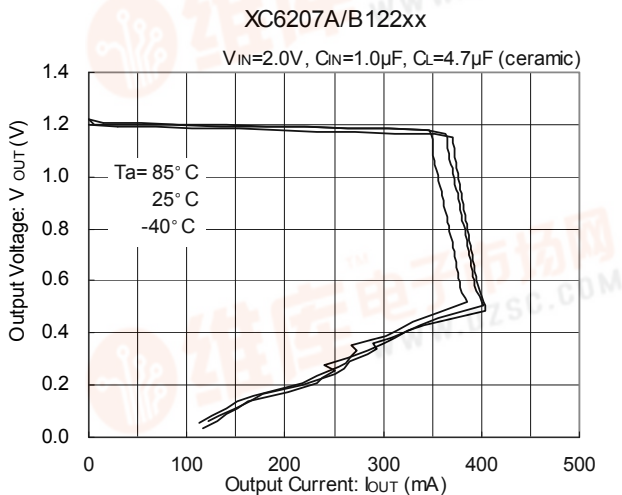

TYPICAL PERFORMANCE CHARACTERISTICS (Continued)

(4) Current Limit (Continued)

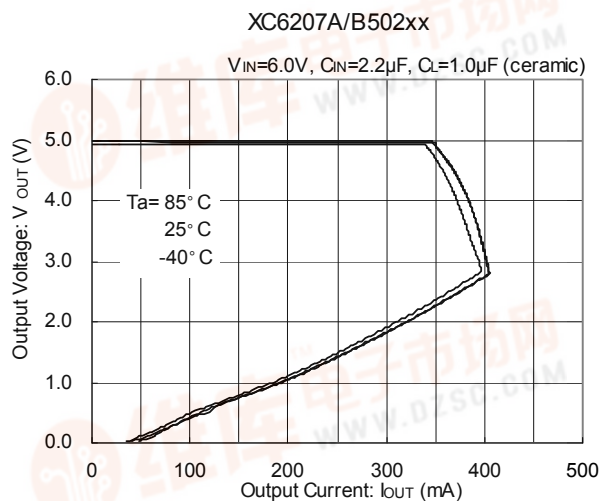
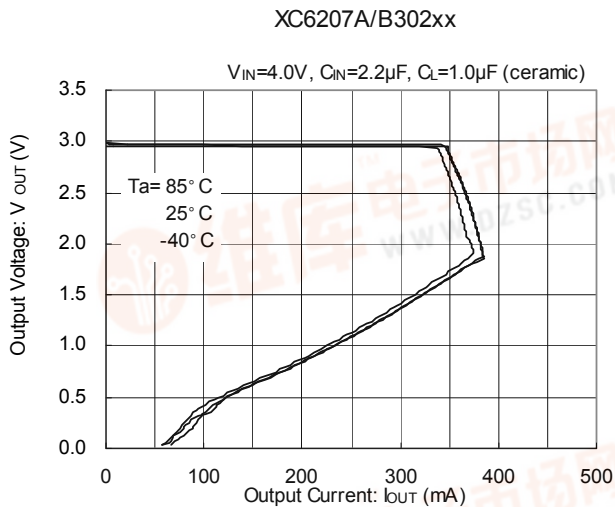

(5) High speed / Power Save Switching Current

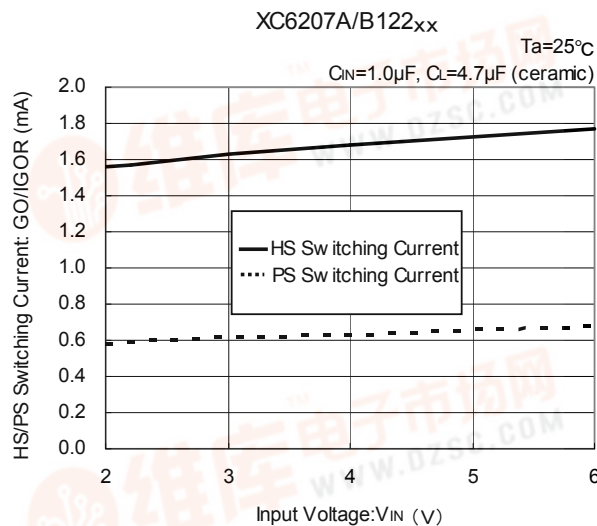
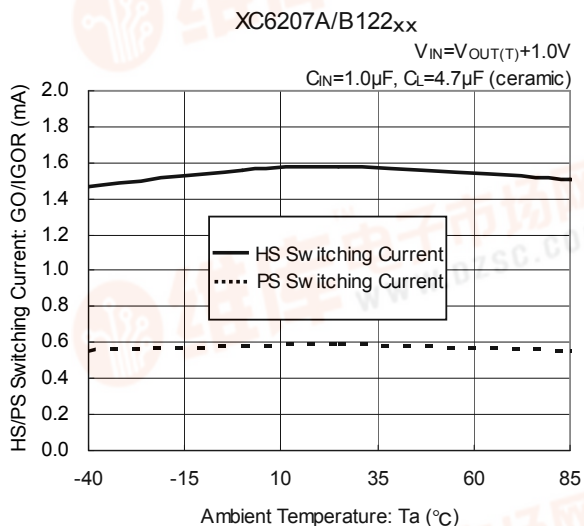

(6) Power Save Switching Delay Time

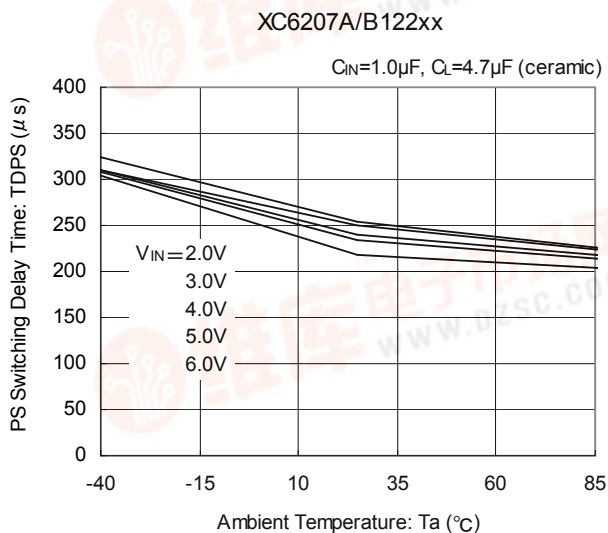

(7) CL Discharge Resistance

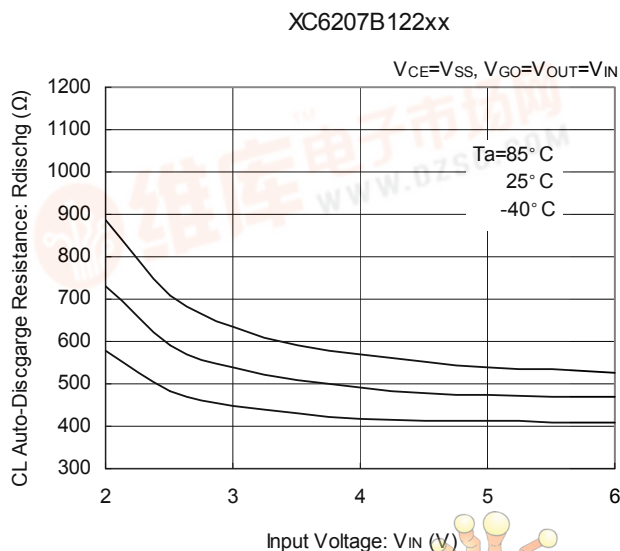

TYPICAL PERFORMANCE CHARACTERISTICS (Continued)

(8) Load Transient Response

XC6207A/B122xx

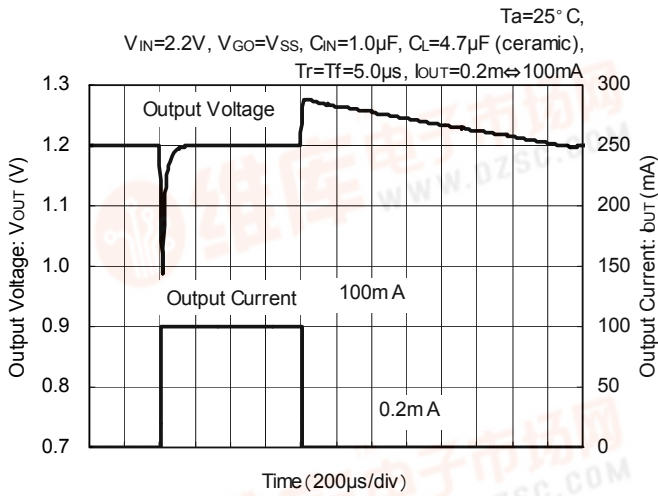

XC6207A/B122xx

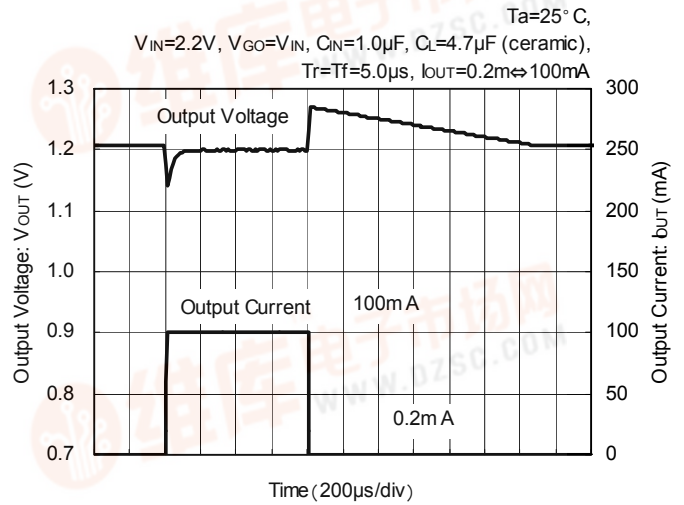

XC6207A/B122xx

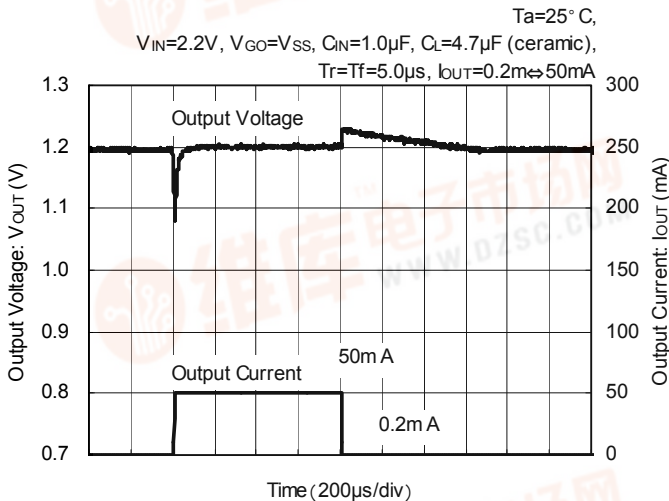

XC6207A/B122xx

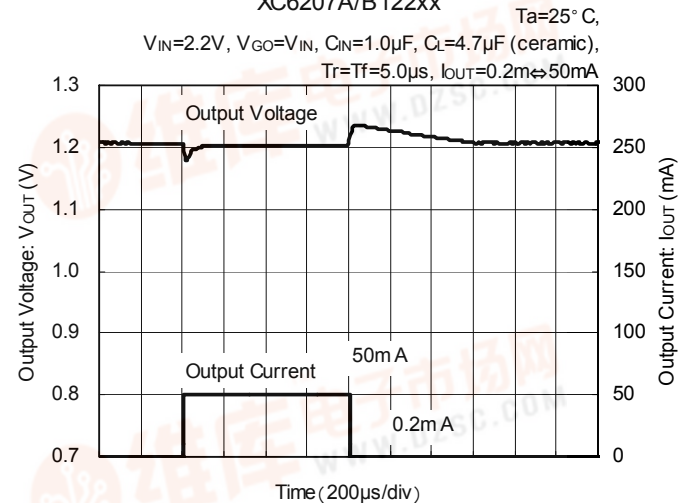

XC6207A/B122xx

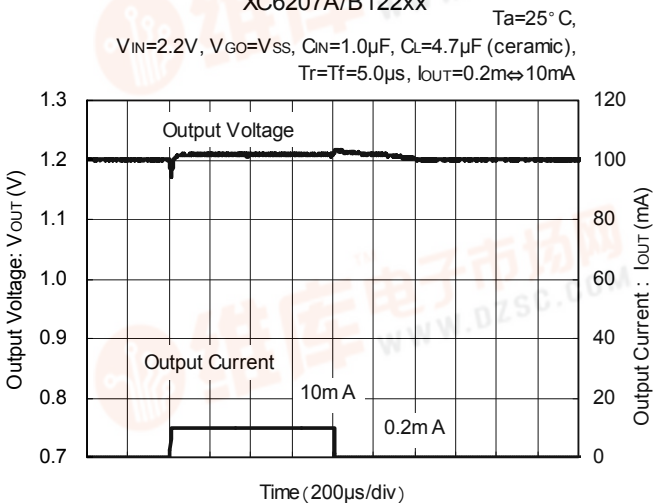

XC6207A/B122xx

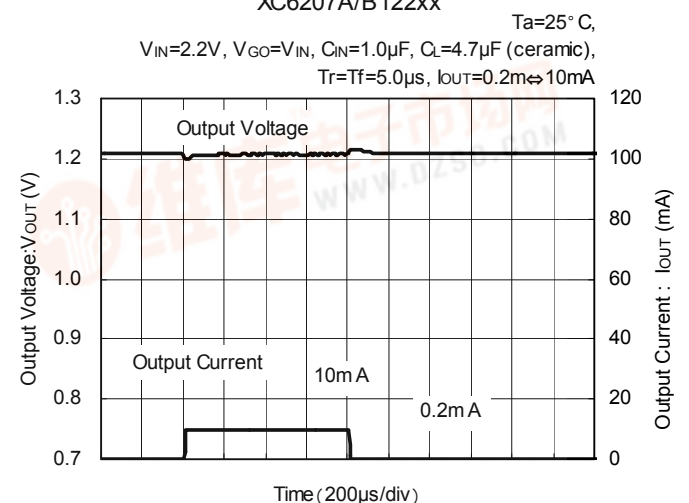

TYPICAL PERFORMANCE CHARACTERISTICS (Continued)

(8) Load Transient Response (Continued)

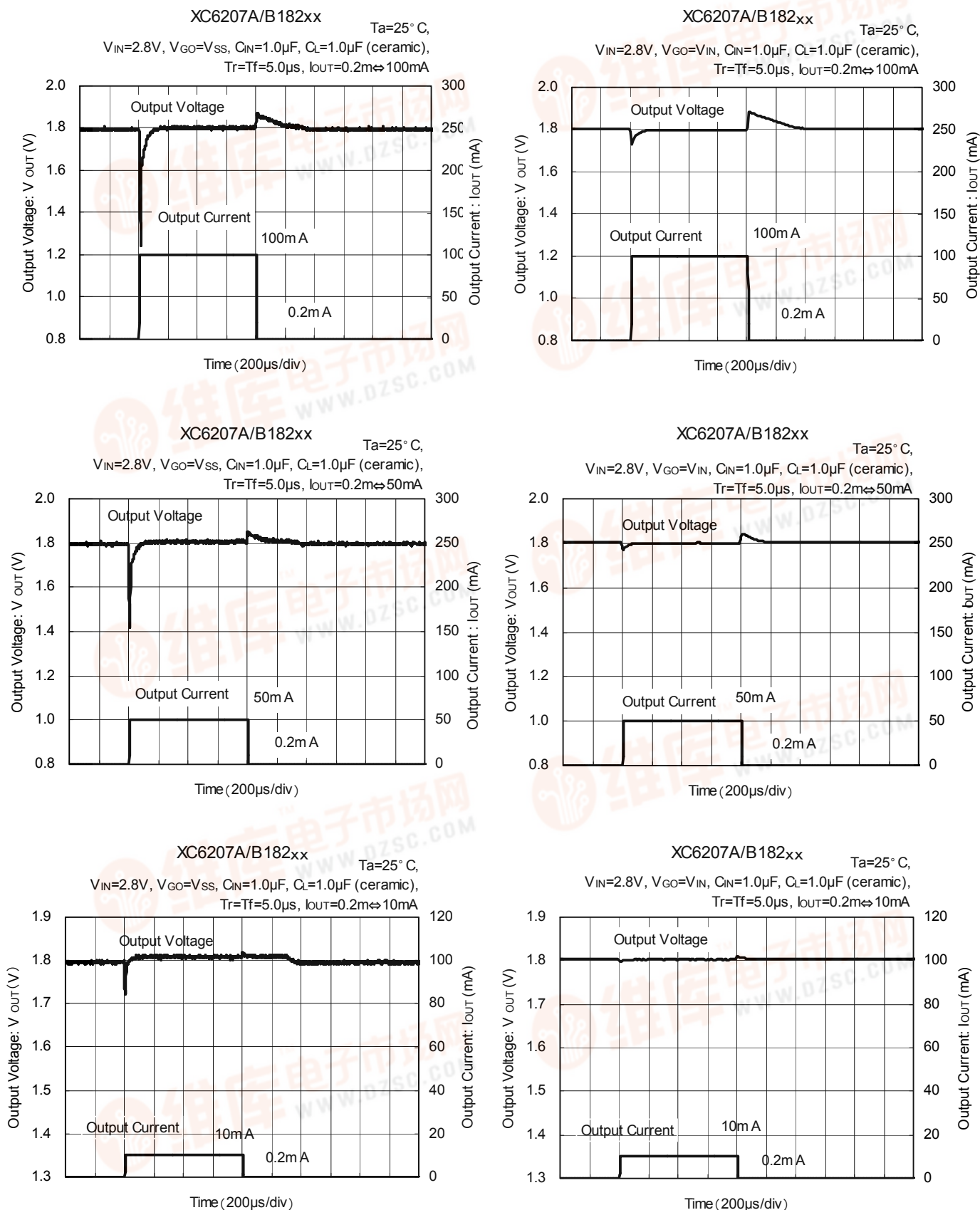

TYPICAL PERFORMANCE CHARACTERISTICS (Continued)

(8) Load Transient Response (Continued)

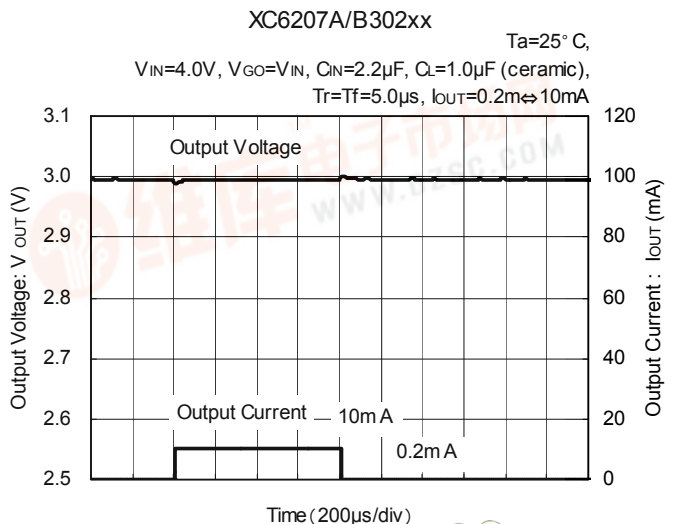
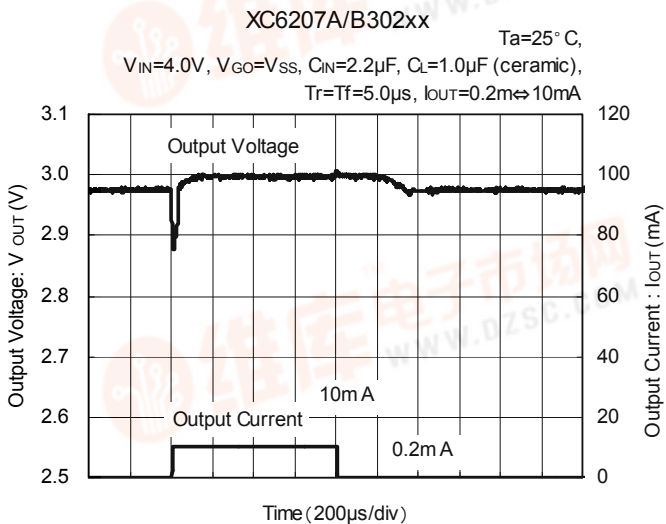
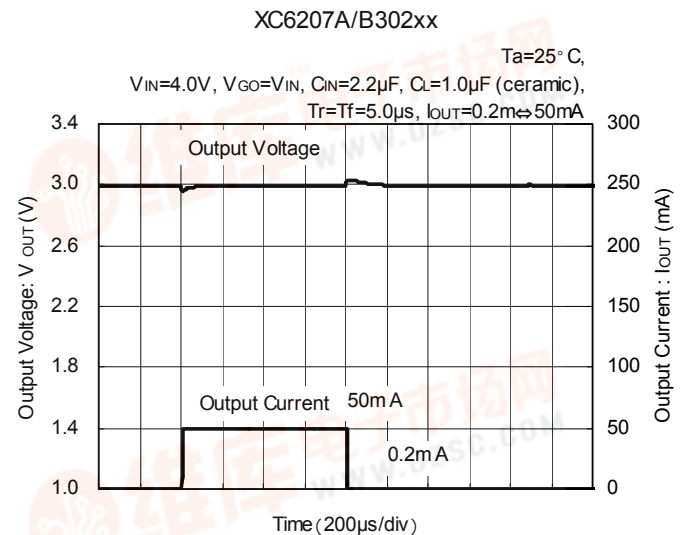
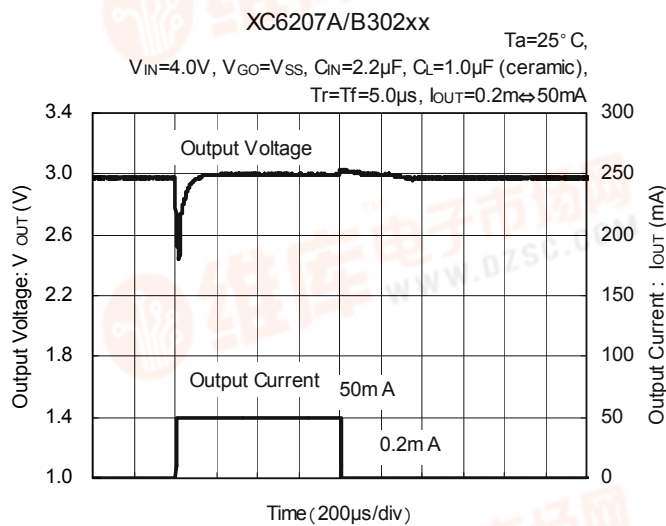
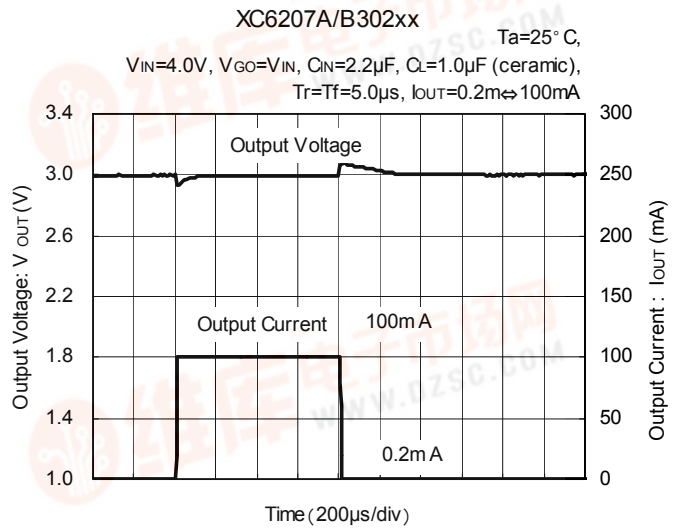
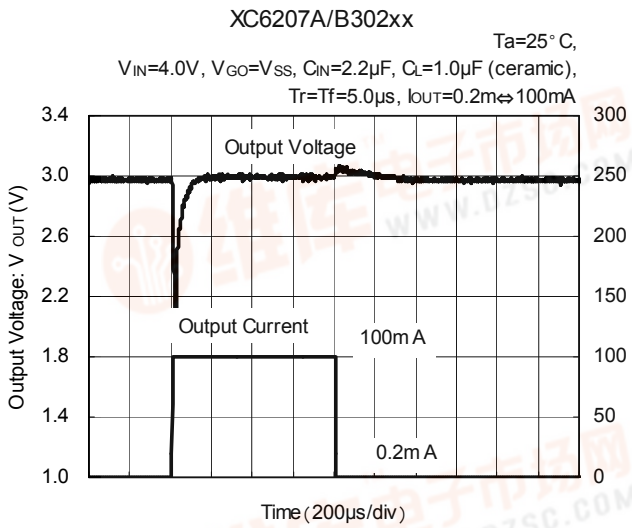

TYPICAL PERFORMANCE CHARACTERISTICS (Continued)

(8) Load Transient Response (Continued)

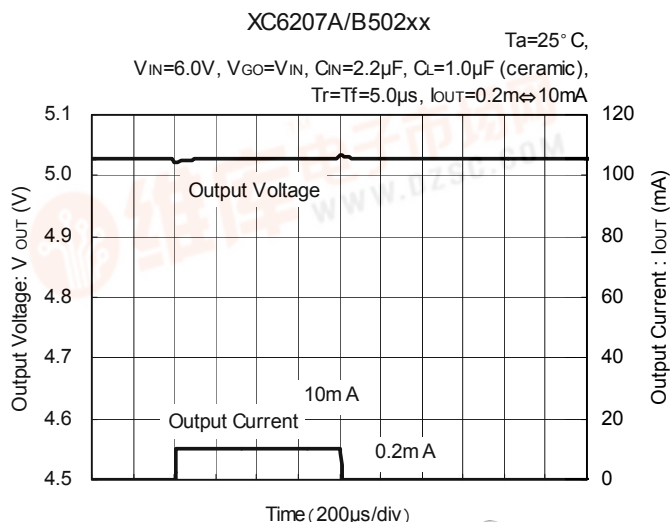
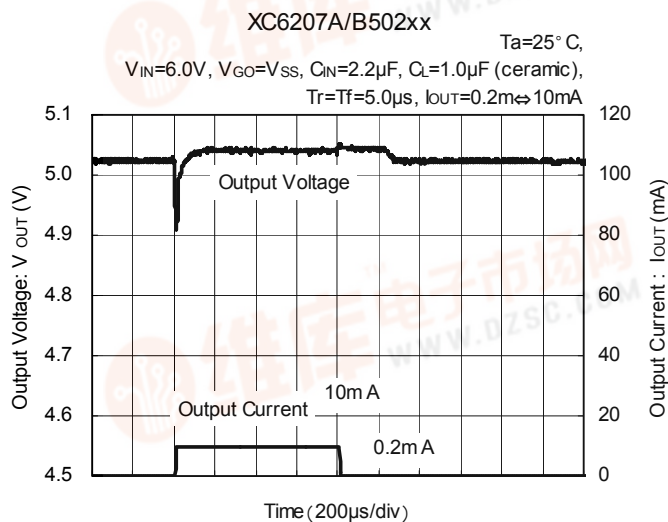
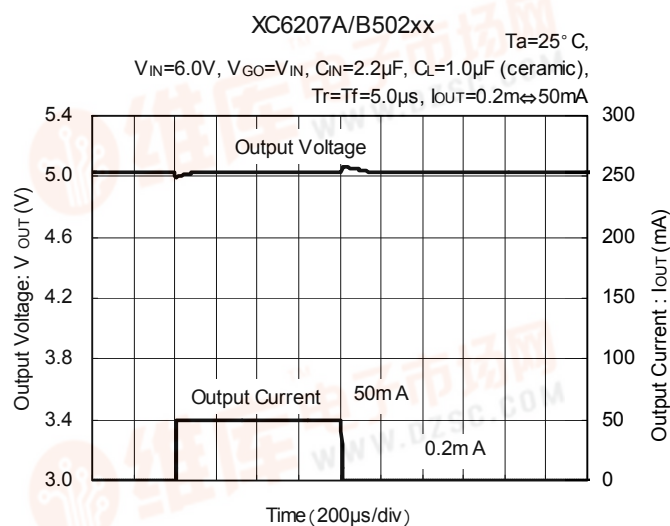
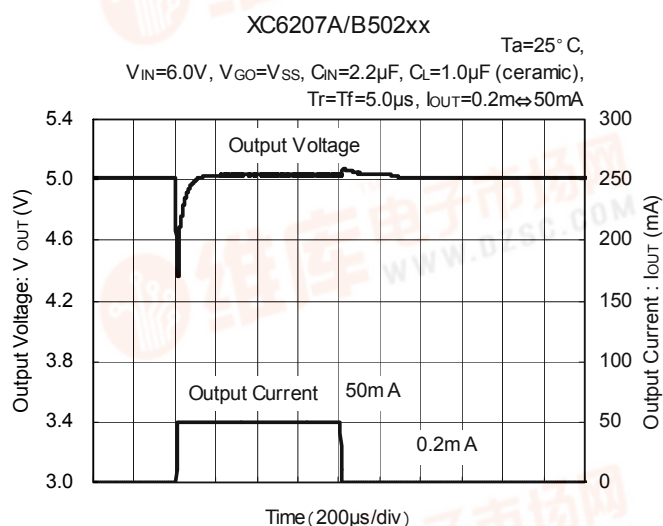
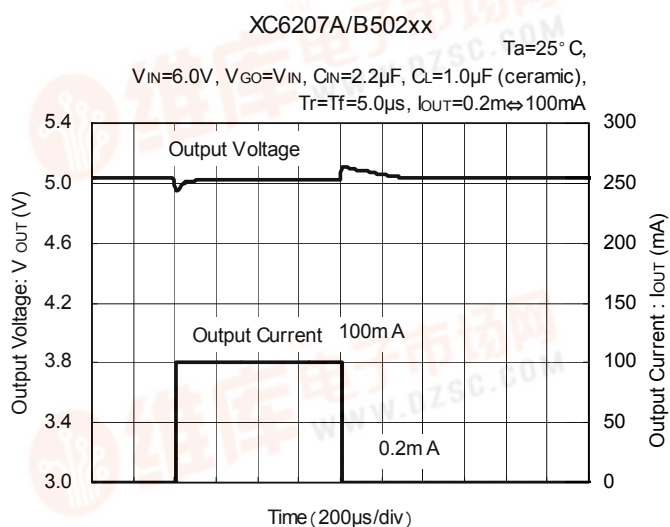
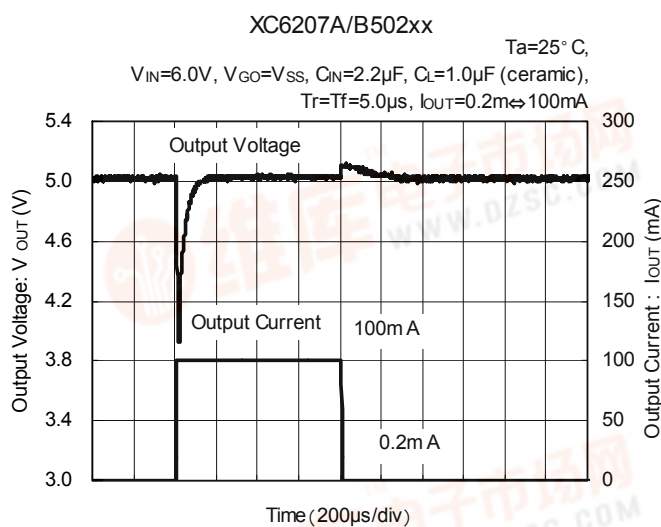

TYPICAL PERFORMANCE CHARACTERISTICS (Continued)

(8) Load Transient Response (Continued)

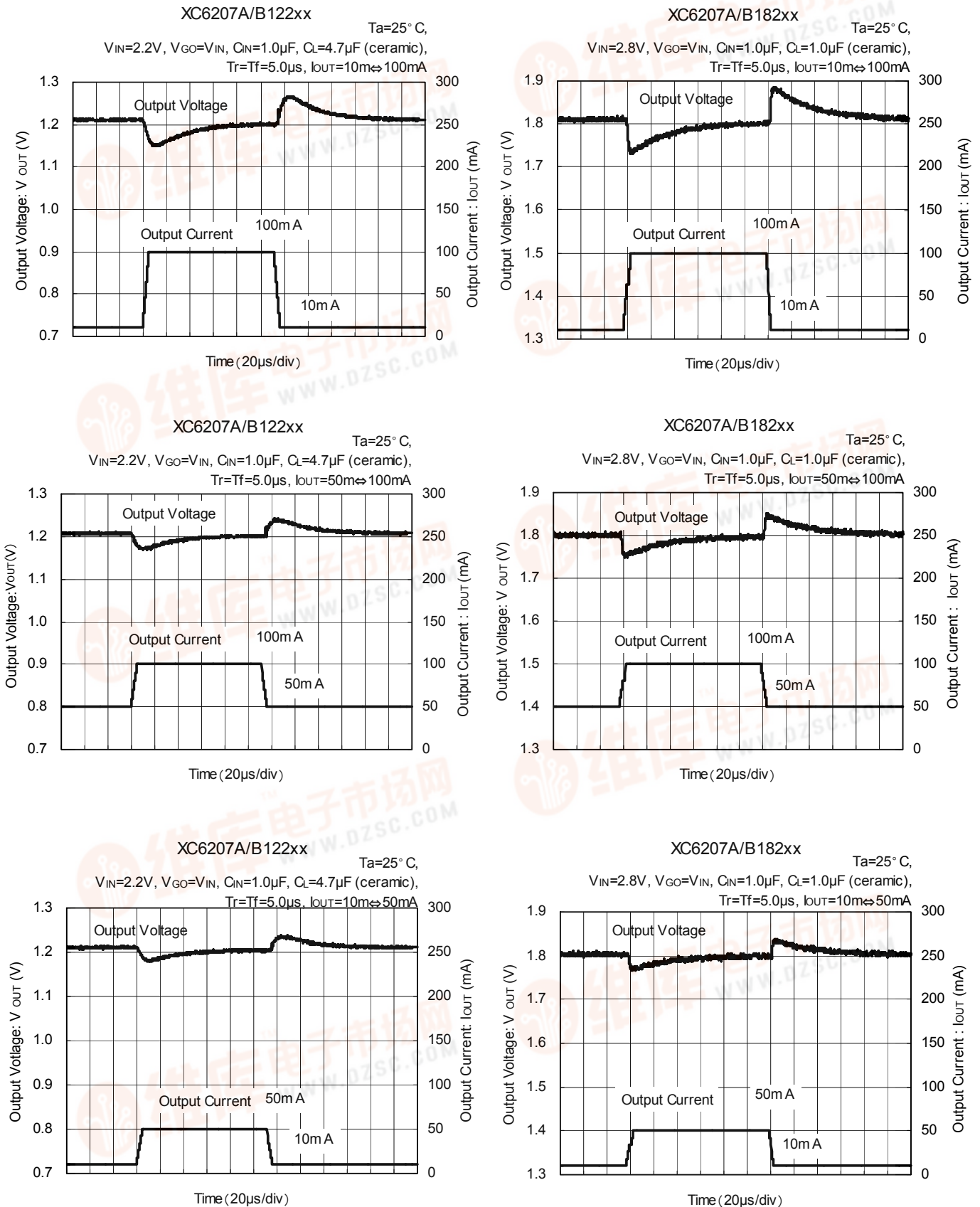

TYPICAL PERFORMANCE CHARACTERISTICS (Continued)

(8) Load Transient Response (Continued)

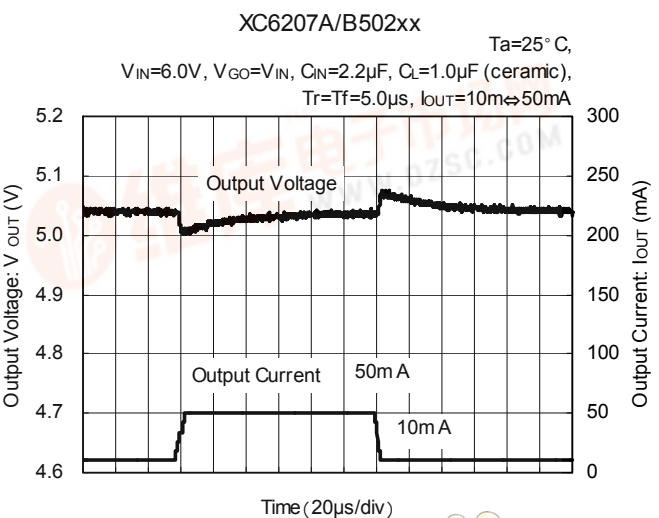
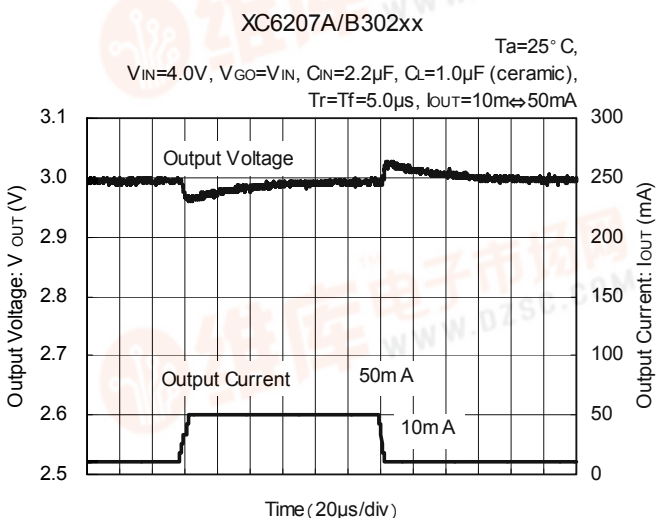
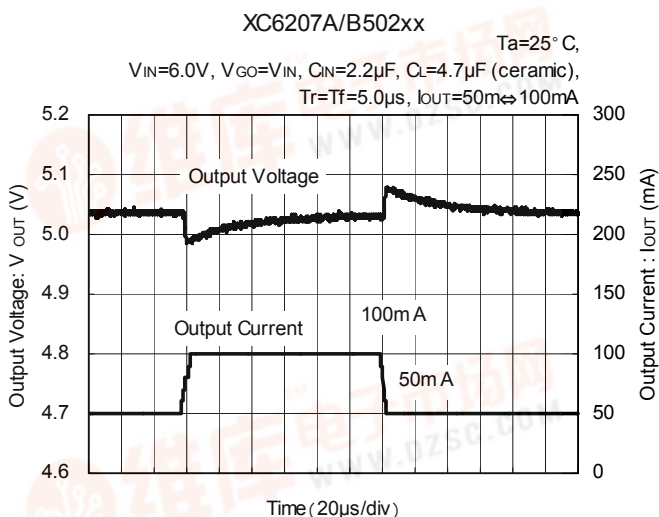
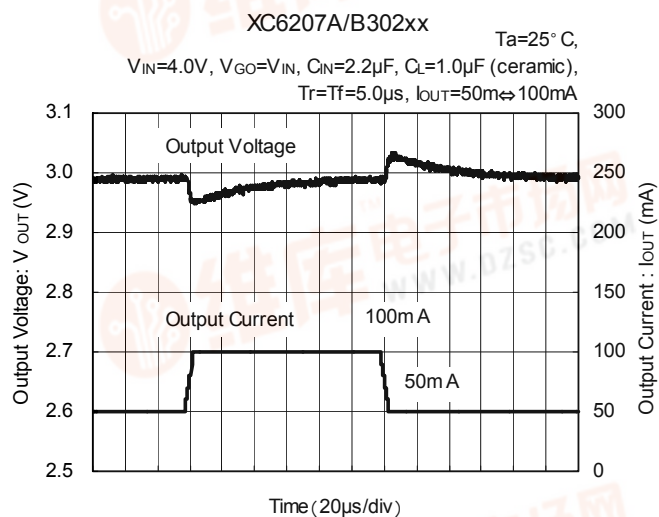
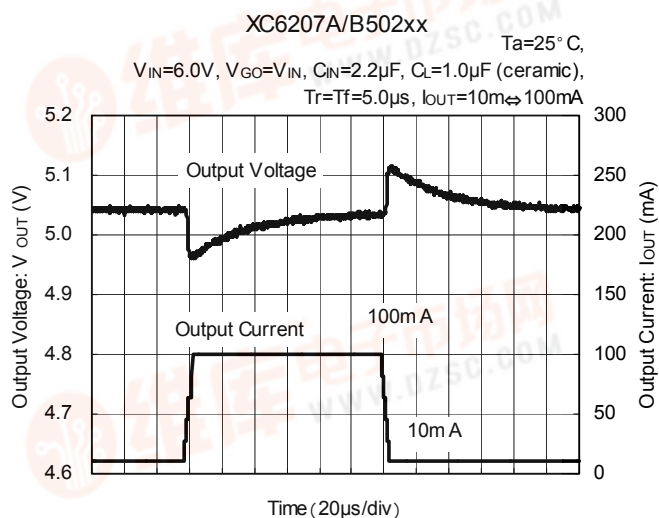
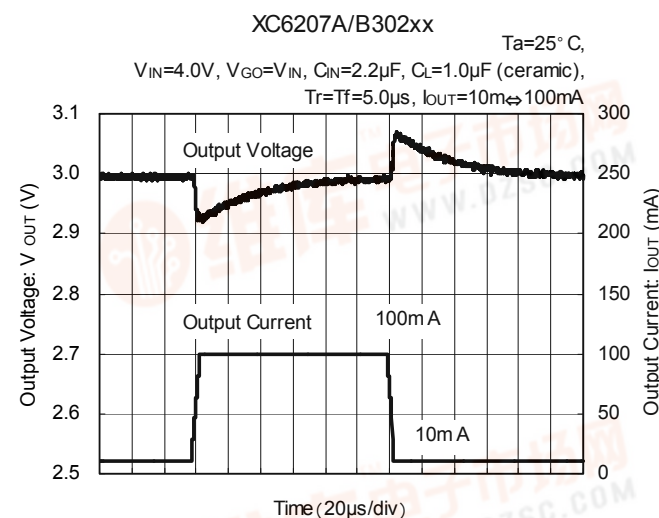

TYPICAL PERFORMANCE CHARACTERISTICS (Continued)

(9) Input Transient Response

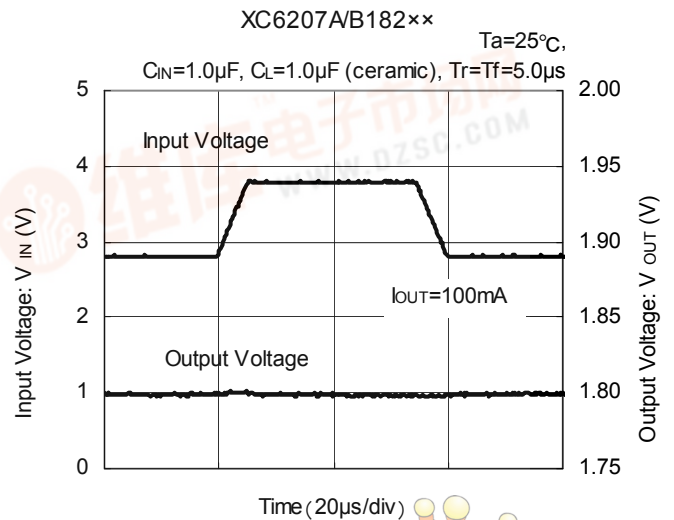
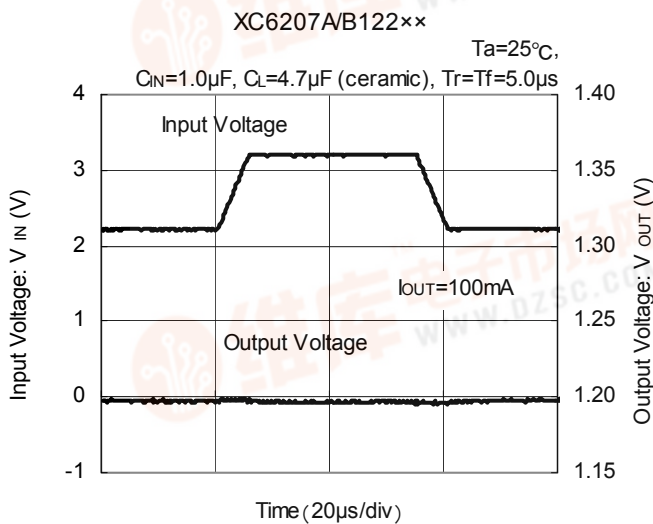
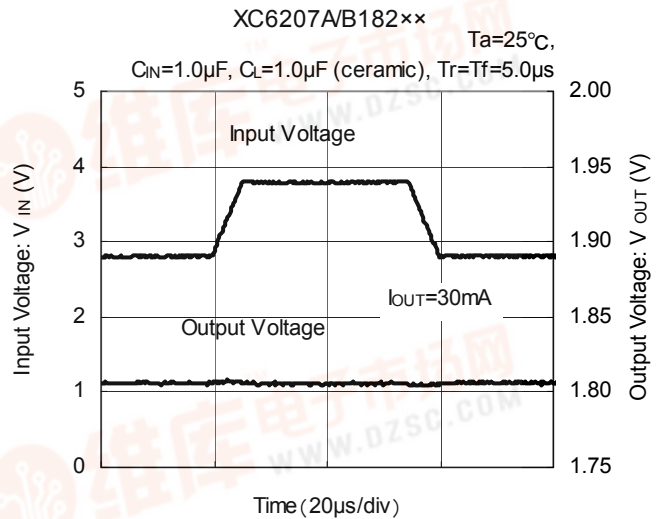
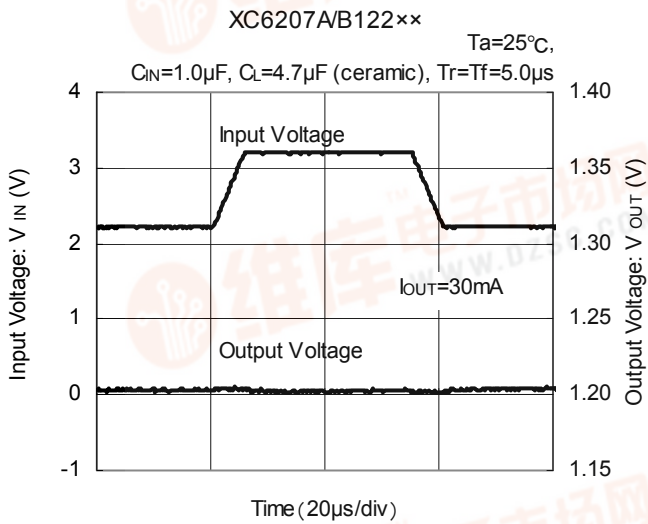
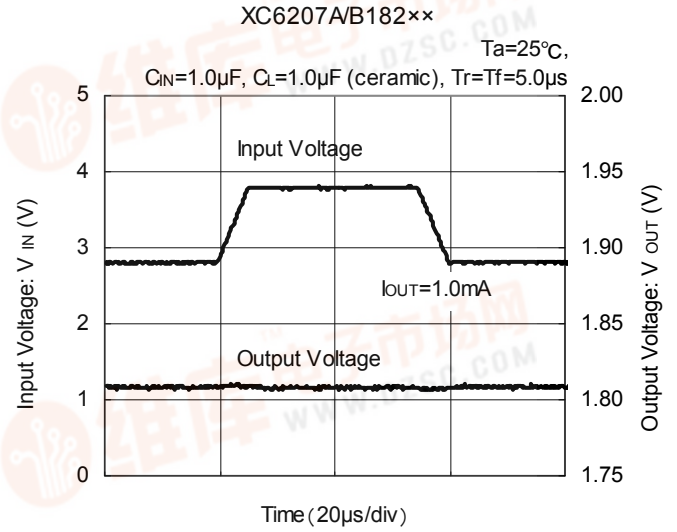
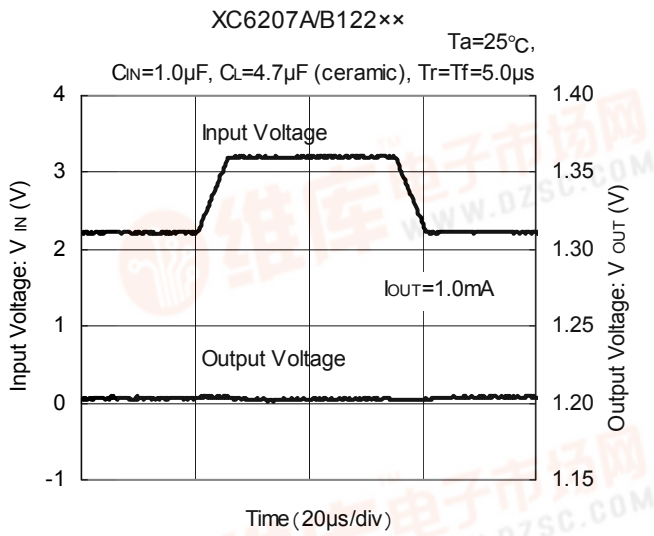

TYPICAL PERFORMANCE CHARACTERISTICS (Continued)

(9) Input Transient Response (Continued)

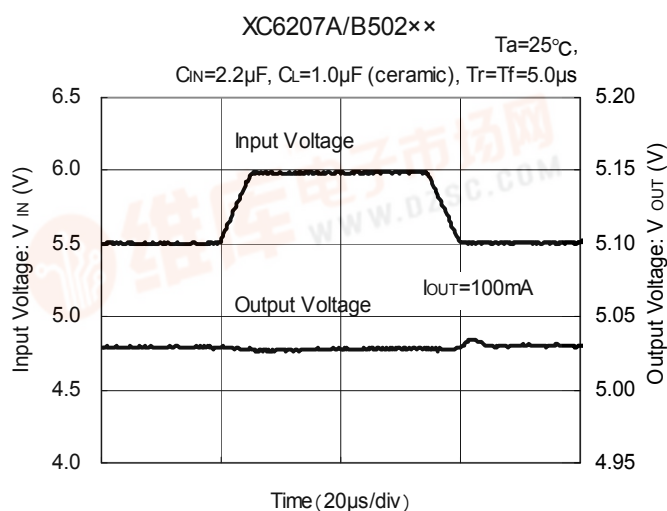
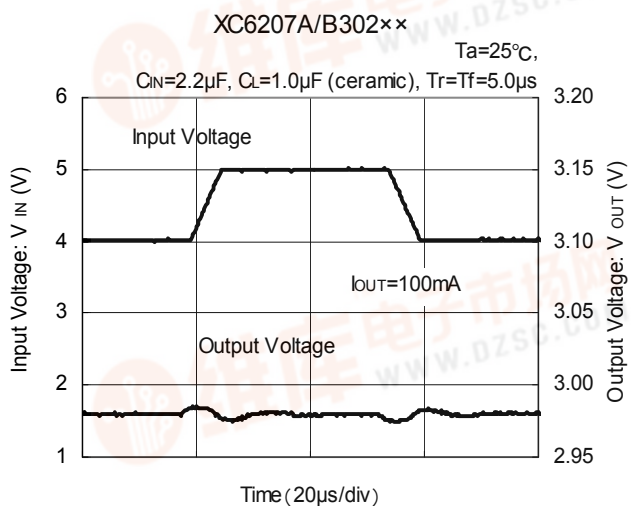
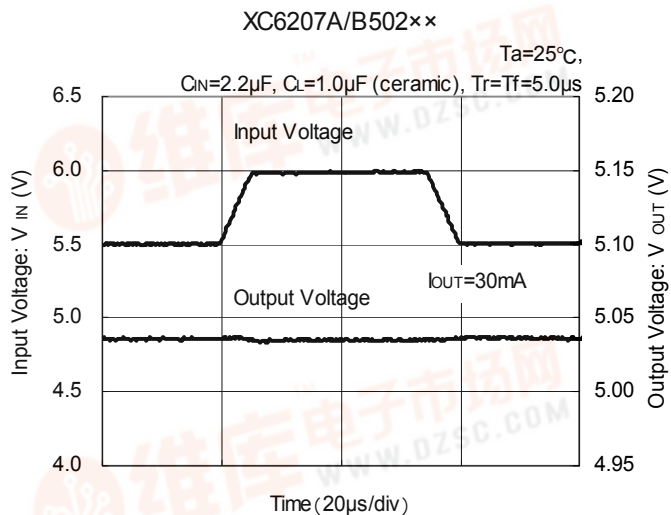
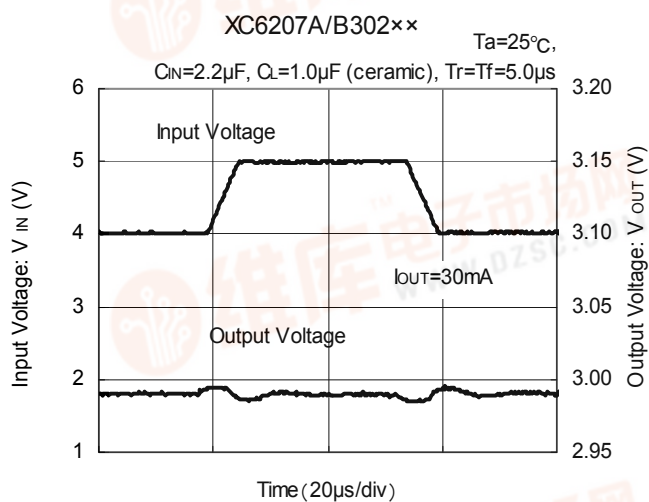
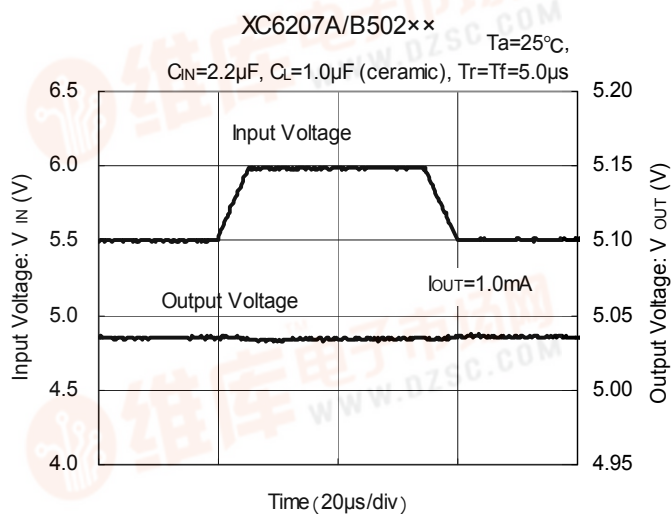
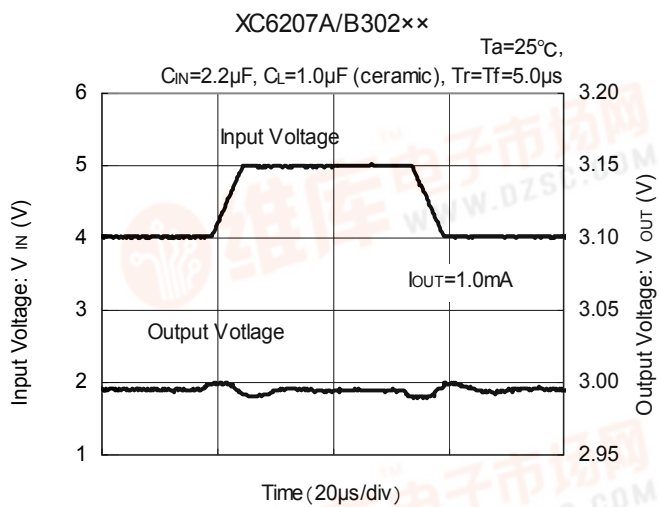

TYPICAL PERFORMANCE CHARACTERISTICS (Continued)

(10) Enable Response Time

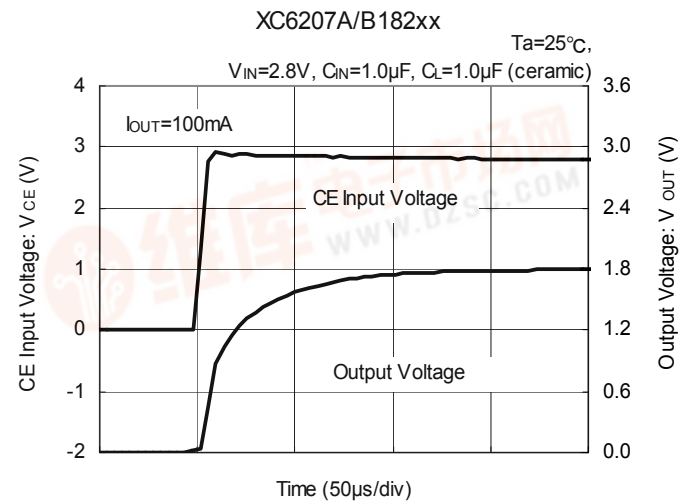
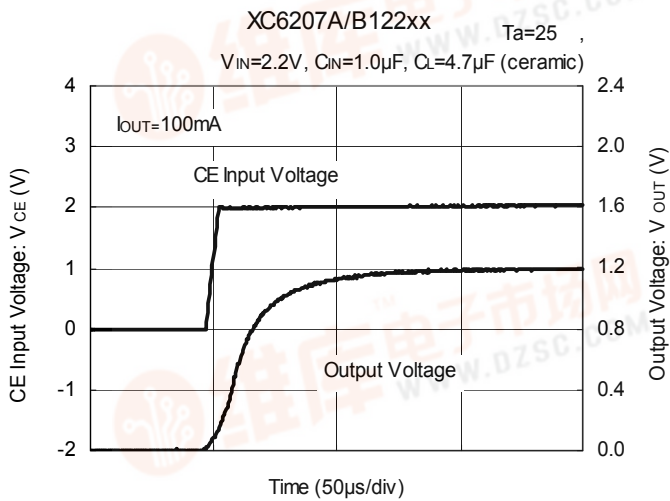
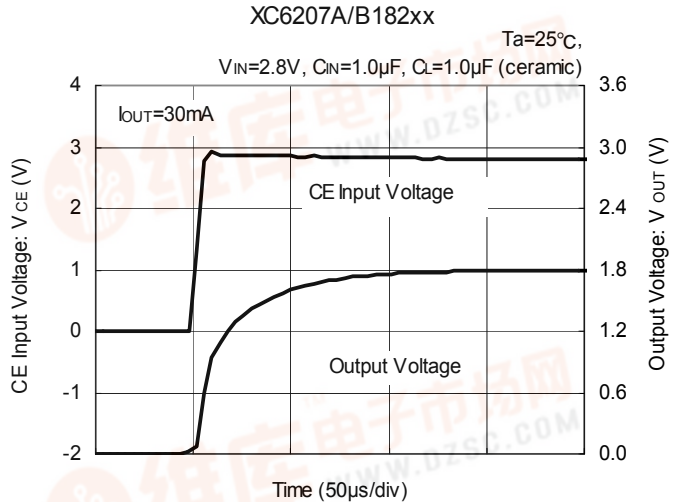
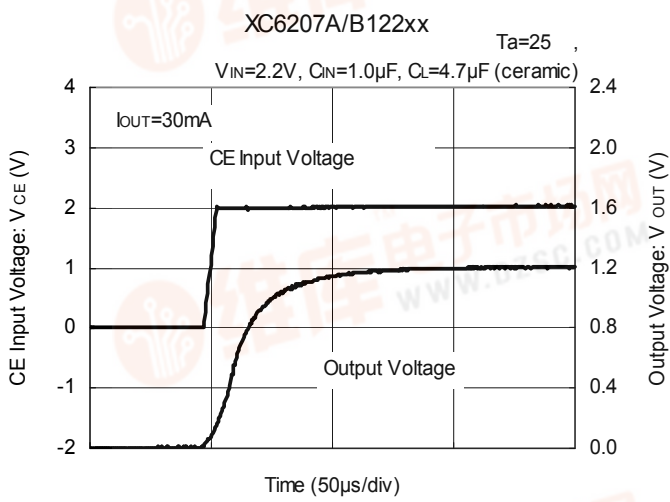
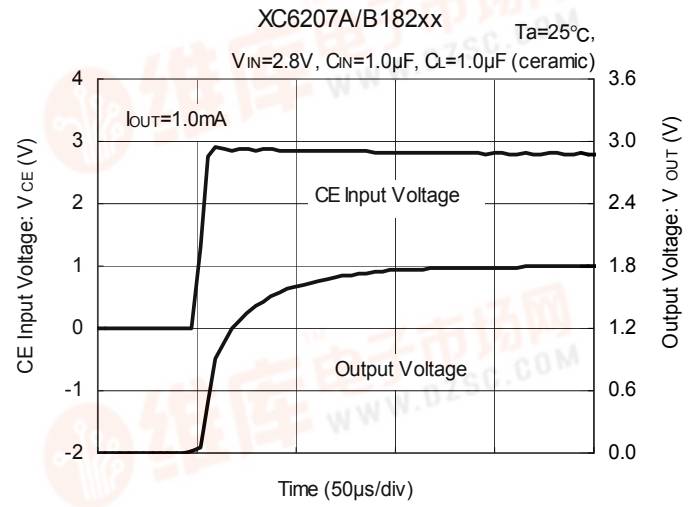
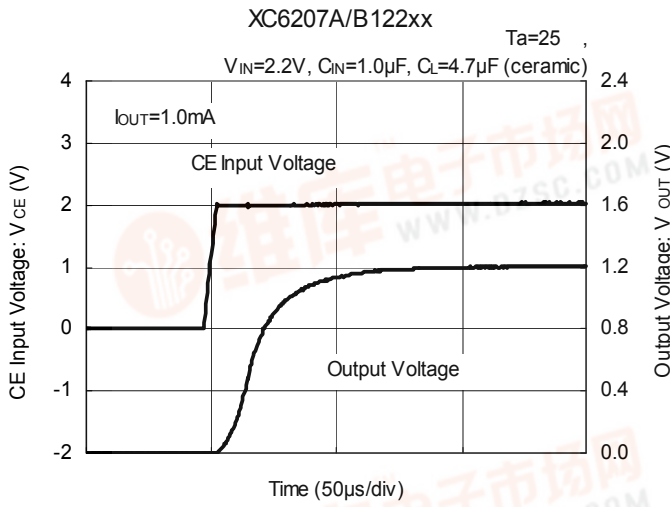

TYPICAL PERFORMANCE CHARACTERISTICS (Continued)

(10) Enable Response Time (Continued)

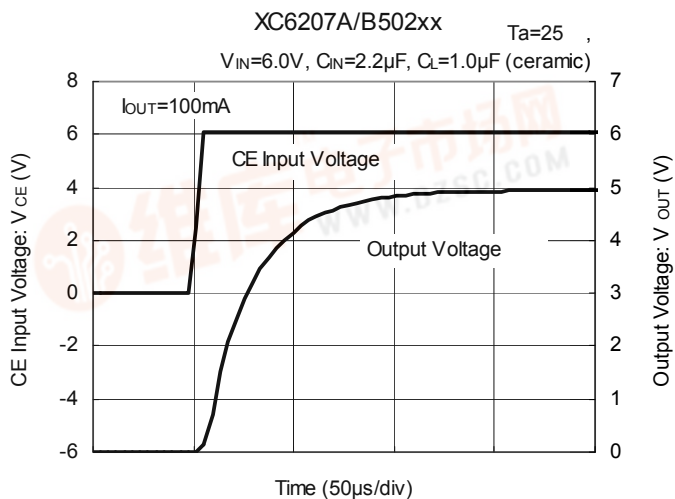
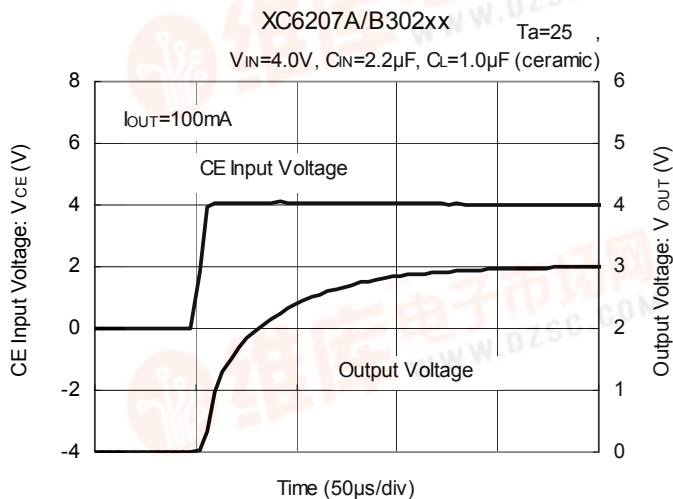
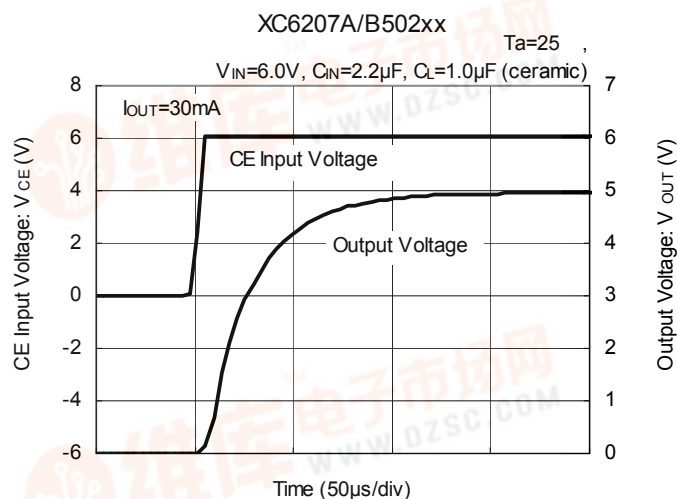
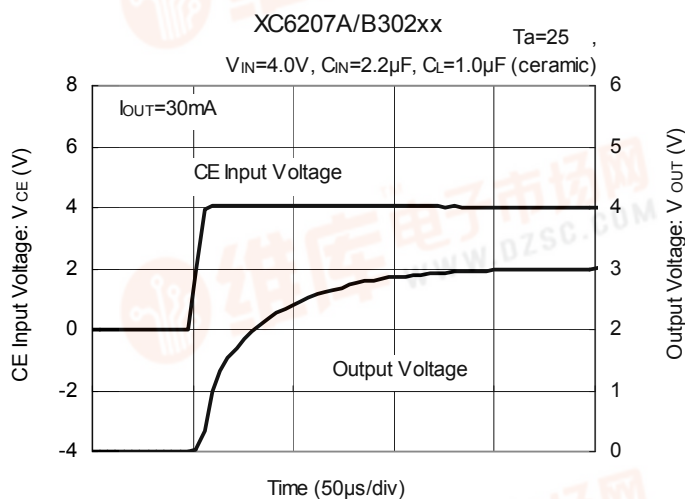
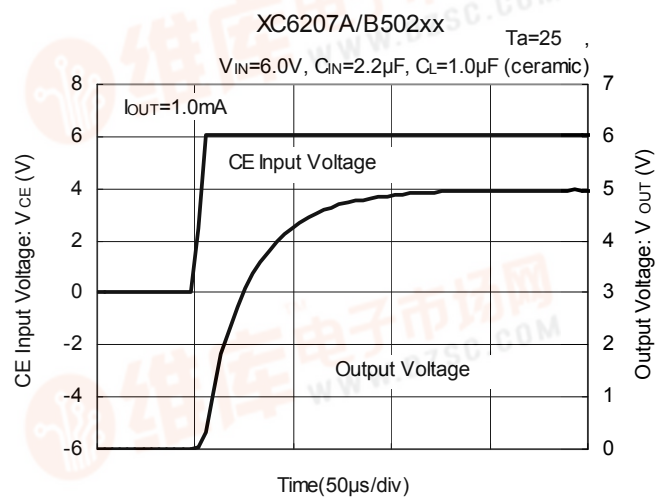
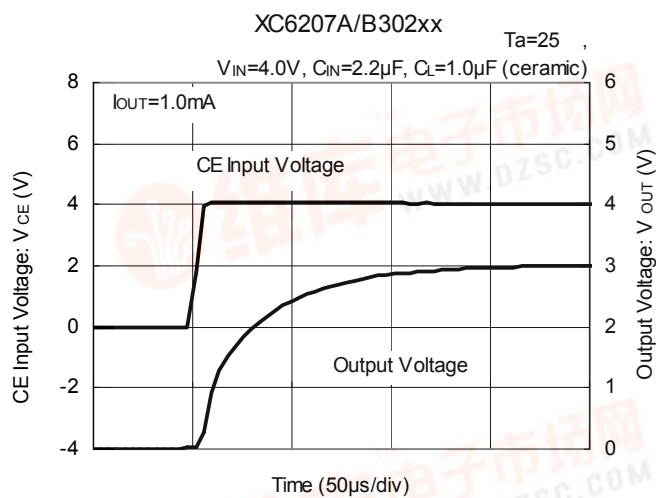

TYPICAL PERFORMANCE CHARACTERISTICS (Continued)

(11) Ripple Rejection Rate

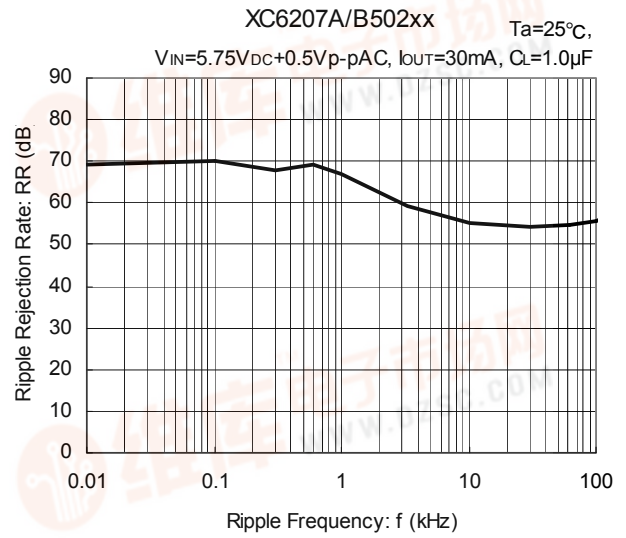
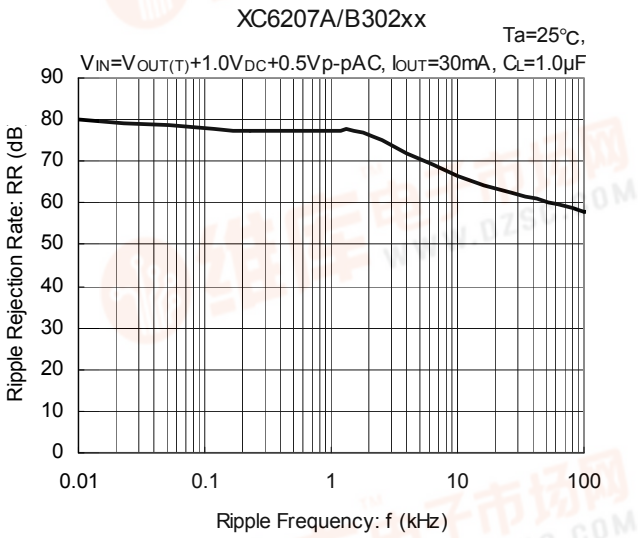
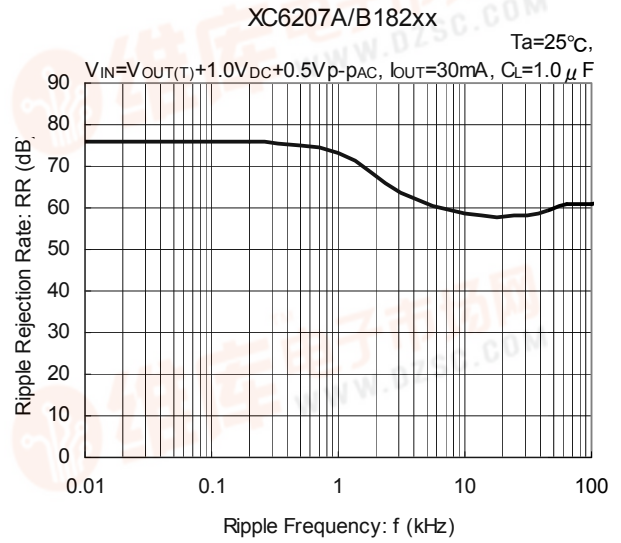
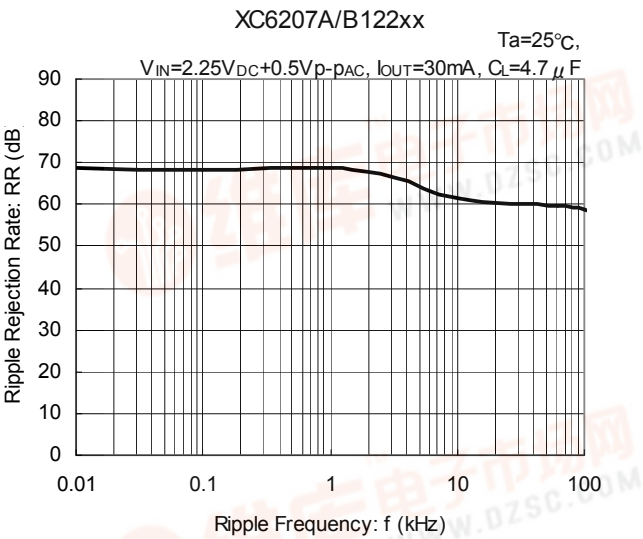

[查询XC6207供应商](#)

PACKAGING INFORMATION

SOT-25

(unit : mm)

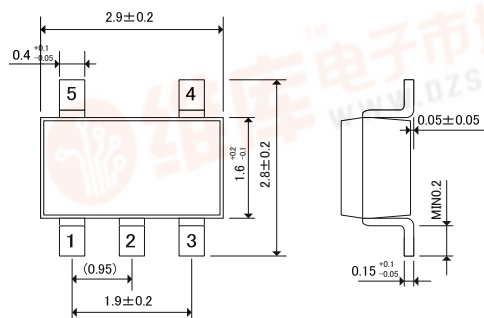

SOT-89-5

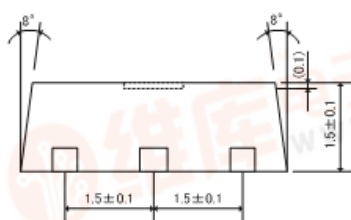
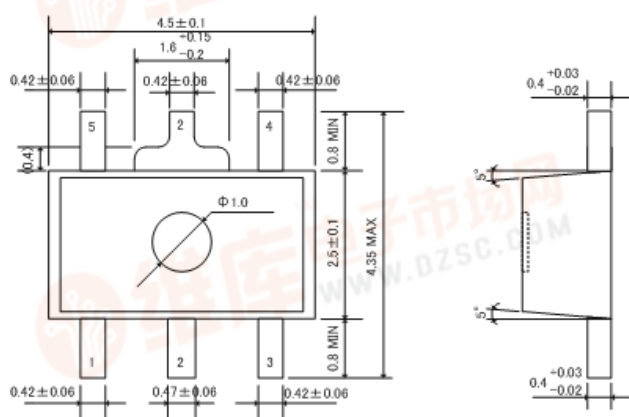

PACKAGING INFORMATION (Continued)

USP-6C

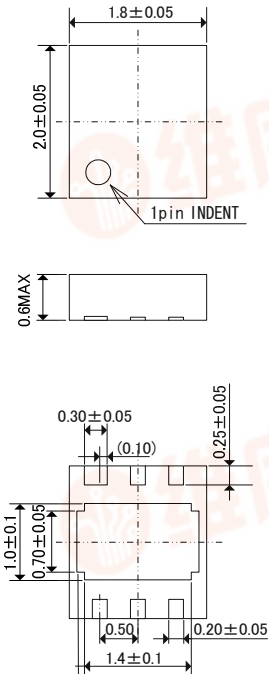

USP-6C Package

USP-6C Reference Pattern Layout

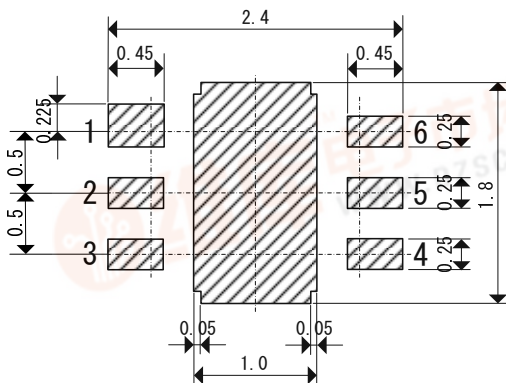

USP-6C Reference Metal Mask Design

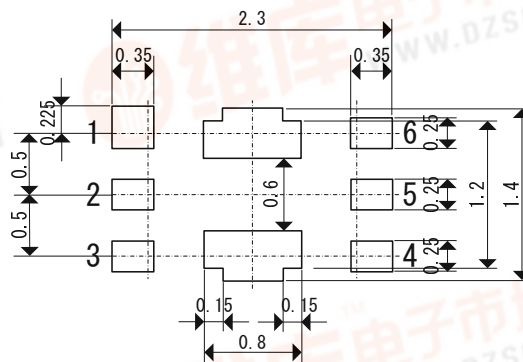

MARKING RULE

SOT-25, SOT-89-5

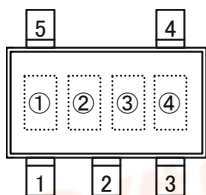

SOT-25
(TOP VIEW)

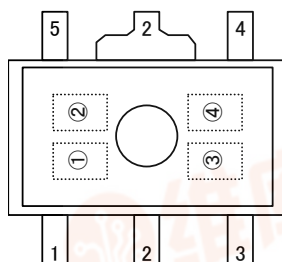

SOT-89-5
(TOP VIEW)

represents product series

MARK	PRODUCT SERIES
7	XC6207*****

represents type of regulator

MARK		PRODUCT SERIES
OUTPUT VOLTAGE 0.1V INCREMENTS	OUTPUT VOLTAGE 0.05V INCREMENTS	
A	N	XC6207A*****
B	P	XC6207B*****

represents output voltage

MARK	OUTPUT VOLTAGE (V)				MARK	OUTPUT VOLTAGE (V)			
0	-	3.1	-	3.15	F	1.6	4.6	1.65	4.65
1	-	3.2	-	3.25	H	1.7	4.7	1.75	4.75
2	-	3.3	-	3.35	K	1.8	4.8	1.85	4.85
3	-	3.4	-	3.45	L	1.9	4.9	1.95	4.95
4	-	3.5	-	3.55	M	2.0	5.0	2.05	-
5	-	3.6	-	3.65	N	2.1	-	2.15	-
6	-	3.7	-	3.75	P	2.2	-	2.25	-
7	0.8	3.8	0.85	3.85	R	2.3	-	2.35	-
8	0.9	3.9	0.95	3.95	S	2.4	-	2.45	-
9	1.0	4.0	1.05	4.05	T	2.5	-	2.55	-
A	1.1	4.1	1.15	4.15	U	2.6	-	2.65	-
B	1.2	4.2	1.25	4.25	V	2.7	-	2.75	-
C	1.3	4.3	1.35	4.35	X	2.8	-	2.85	-
D	1.4	4.4	1.45	4.45	Y	2.9	-	2.95	-
E	1.5	4.5	1.55	4.55	Z	3.0	-	3.05	-

represents production lot number

0 to 9, A to Z reverse character 0 to 9, A to Z repeated
(G, I, J, O, Q, W excluded)

MARKING RULE (Continued)

USP-6C

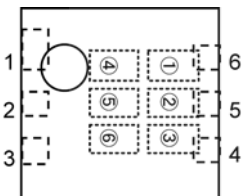

USP-6C
(TOP VIEW)

represents product series

MARK		PRODUCT SERIES
①	②	
0	7	XC6207*****

represents type of regulator

MARK	TYPE	PRODUCT SERIES
A	High Active with No Pull-Down Resistor, No C _L Discharge Resistor	XC6207A***D*
B	High Active with No Pull-Down Resistor, with C _L Discharge Resistor	XC6207B***D*

represents integer of the output voltage (ex.)

MARK	VOLTAGE (V)	PRODUCT SERIES
3	3.X	XC6207*3**D*
5	5.X	XC6207*5**D*

represents decimal number of the output voltage

MARK	VOLTAGE (V)	PRODUCT SERIES	MARK	VOLTAGE (V)	PRODUCT SERIES
0	X.0	XC6207**02/1D*	A	X.05	XC6207**0A/BD*
1	X.1	XC6207**12/1D*	B	X.15	XC6207**1A/BD*
2	X.2	XC6207**22/1D*	C	X.25	XC6207**2A/BD*
3	X.3	XC6207**32/1D*	D	X.35	XC6207**3A/BD*
4	X.4	XC6207**42/1D*	E	X.45	XC6207**4A/BD*
5	X.5	XC6207**52/1D*	F	X.55	XC6207**5A/BD*
6	X.6	XC6207**62/1D*	H	X.65	XC6207**6A/BD*
7	X.7	XC6207**72/1D*	K	X.75	XC6207**7A/BD*
8	X.8	XC6207**82/1D*	L	X.85	XC6207**8A/BD*
9	X.9	XC6207**92/1Dx	M	X.95	XC6207**9A/BD*

represents production lot number

0 to 9, A to Z repeated (G, I, J, O, Q, W excluded)

*No character inversion used.

1. The products and product specifications contained herein are subject to change without notice to improve performance characteristics. Consult us, or our representatives before use, to confirm that the information in this datasheet is up to date.
2. We assume no responsibility for any infringement of patents, patent rights, or other rights arising from the use of any information and circuitry in this datasheet.
3. Please ensure suitable shipping controls (including fail-safe designs and aging protection) are in force for equipment employing products listed in this datasheet.
4. The products in this datasheet are not developed, designed, or approved for use with such equipment whose failure or malfunction can be reasonably expected to directly endanger the life of, or cause significant injury to, the user.
(e.g. Atomic energy; aerospace; transport; combustion and associated safety equipment thereof.)
5. Please use the products listed in this datasheet within the specified ranges.
Should you wish to use the products under conditions exceeding the specifications, please consult us or our representatives.
6. We assume no responsibility for damage or loss due to abnormal use.
7. All rights reserved. No part of this datasheet may be copied or reproduced without the prior permission of TOREX SEMICONDUCTOR LTD.

TOREX SEMICONDUCTOR LTD.