

FEATURES

- RF frequency range of 500 MHz to 1700 MHz
- IF frequency range of 30 MHz to 450 MHz
- Power conversion loss: 7.7 dB
- SSB noise figure of 8.3 dB
- SSB noise figure with 5 dBm blocker of 21 dB
- Input IP3 of 34 dBm
- Typical LO drive of 0 dBm
- Single-ended, 50 Ω RF and LO input ports
- High isolation SPDT LO input switch
- Single-supply operation: 3.3 V to 5 V
- Exposed paddle 5 mm × 5 mm, 20-lead LFCSP
- 1500 V HBM/500 V FICDM ESD performance

APPLICATIONS

- Cellular base station receivers
- Transmit observation receivers
- Radio link downconverters

GENERAL DESCRIPTION

The ADL5367 uses a highly linear, doubly balanced passive mixer core along with integrated RF and LO balancing circuitry to allow for single-ended operation. The ADL5367 incorporates an RF balun, allowing optimal performance over a 500 MHz to 1700 MHz RF input frequency range. Performance is optimized for RF frequencies from 500 MHz to 1200 MHz using a high-side LO and for RF frequencies from 900 MHz to 1700 MHz using a low-side LO. The balanced passive mixer arrangement provides good LO-to-RF leakage, typically better than -35 dBm, and excellent intermodulation performance. The balanced mixer core also provides extremely high input linearity, allowing the device to be used in demanding cellular applications where in-band blocking signals may otherwise result in the degradation of dynamic performance. A high linearity IF buffer amplifier follows the passive mixer core to yield a typical power conversion loss of 7.7 dB and can be used with a wide range of output impedances.

FUNCTIONAL BLOCK DIAGRAM

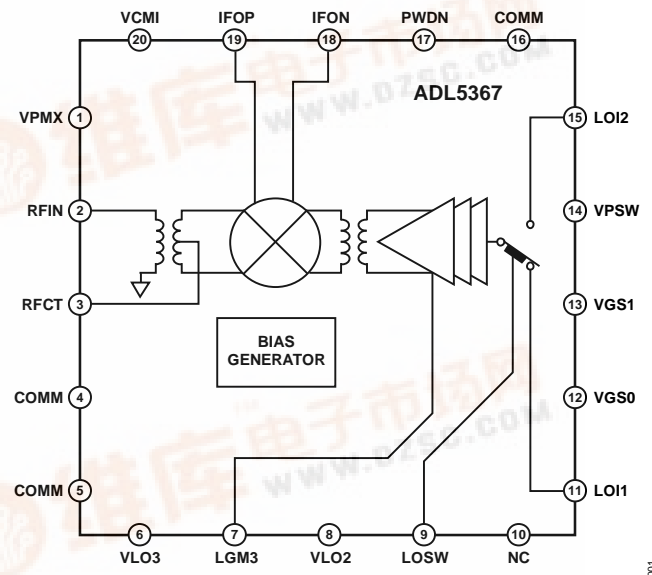

NC = NO CONNECT

Figure 1.

The ADL5367 provides two switched LO paths that can be used in TDD applications where it is desirable to rapidly switch between two local oscillators. LO current can be externally set using a resistor to minimize dc current commensurate with the desired level of performance. For low voltage applications, the ADL5367 is capable of operation at voltages down to 3.3 V with substantially reduced current. Under low voltage operation, an additional logic pin is provided to power down (<200 μA) the circuit when desired.

The ADL5367 is fabricated using a BiCMOS high performance IC process. The device is available in a 5 mm × 5 mm, 20-lead LFCSP and operates over a -40°C to +85°C temperature range. An evaluation board is also available.

Table 1. Passive Mixers

RF Frequency (MHz)	Single Mixer	Single Mixer + IF Amp	Dual Mixer + IF Amp
500 to 1700	ADL5367	ADL5357	ADL5358
1200 to 2500	ADL5365	ADL5355	ADL5356

Rev. 0

Information furnished by Analog Devices is believed to be accurate and reliable. However, no responsibility is assumed by Analog Devices for its use, nor for any infringements of patents or other rights of third parties that may result from its use. Specifications subject to change without notice. No license is granted by implication or otherwise under any patent or patent rights of Analog Devices. Trademarks and registered trademarks are the property of their respective owners.



TABLE OF CONTENTS

Features	1	Upconversion	15
Applications	1	Spur Tables	16
General Description	1	Circuit Description	17
Functional Block Diagram	1	RF Subsystem	17
Revision History	2	LO Subsystem	17
Specifications	3	Applications Information	19
5 V Performance	4	Basic Connections	19
3.3 V Performance	4	IF Port	19
Absolute Maximum Ratings	5	Bias Resistor Selection	19
ESD Caution	5	Mixer VGS Control DAC	19
Pin Configuration and Function Descriptions	6	Evaluation Board	20
Typical Performance Characteristics	7	Outline Dimensions	23
5 V Performance	7	Ordering Guide	23
3.3 V Performance	14		

REVISION HISTORY

10/09—Revision 0: Initial Version

SPECIFICATIONS

$V_S = 5\text{ V}$, $I_S = 97\text{ mA}$, $T_A = 25^\circ\text{C}$, $f_{RF} = 900\text{ MHz}$, $f_{LO} = 1103\text{ MHz}$, LO power = 0 dBm, $Z_O = 50\ \Omega$, unless otherwise noted.

Table 2.

Parameter	Conditions	Min	Typ	Max	Unit
RF INPUT INTERFACE					
Return Loss	Tunable to >20 dB over a limited bandwidth		14		dB
Input Impedance			50		Ω
RF Frequency Range		500		1700	MHz
OUTPUT INTERFACE					
Output Impedance	Differential impedance, $f = 200\text{ MHz}$		34 1.9		Ω pF
IF Frequency Range		30		450	MHz
DC Bias Voltage ¹	Externally generated	3.3	5.0	5.5	V
LO INTERFACE					
LO Power		-6	0	+10	dBm
Return Loss			12.6		dB
Input Impedance			50		Ω
LO Frequency Range		730		1670	MHz
POWER-DOWN (PWDN) INTERFACE ²					
PWDN Threshold	Device enabled, IF output to 90% of its final level Device disabled, supply current < 5 mA		1.0		V
Logic 0 Level				0.4	V
Logic 1 Level		1.4			V
PWDN Response Time			160		ns
			220		ns
PWDN Input Bias Current	Device enabled		0.0		μA
	Device disabled		70		μA

¹ Apply the supply voltage from the external circuit through the choke inductors.

² PWDN function is intended for use with $V_S \leq 3.6\text{ V}$ only.

5 V PERFORMANCE

$V_S = 5\text{ V}$, $I_S = 97\text{ mA}$, $T_A = 25^\circ\text{C}$, $f_{RF} = 900\text{ MHz}$, $f_{LO} = 1103\text{ MHz}$, LO power = 0 dBm, VGS0 = VGS1 = 0 V, and $Z_O = 50\ \Omega$, unless otherwise noted.

Table 3.

Parameter	Conditions	Min	Typ	Max	Unit
DYNAMIC PERFORMANCE					
Power Conversion Loss	Including 1:1 IF port transformer and PCB loss	6.5	7.7	8.5	dB
Voltage Conversion Loss	$Z_{SOURCE} = 50\ \Omega$, differential $Z_{LOAD} = 50\ \Omega$ differential		1.4		dB
SSB Noise Figure			8.3		dB
SSB Noise Figure Under Blocking	5 dBm blocker present $\pm 10\text{ MHz}$ from wanted RF input, LO source filtered		21		dB
Input Third-Order Intercept (IIP3)	$f_{RF1} = 899.5\text{ MHz}$, $f_{RF2} = 900.5\text{ MHz}$, $f_{LO} = 1103\text{ MHz}$, each RF tone at 0 dBm	28	34		dBm
Input Second-Order Intercept (IIP2)	$f_{RF1} = 950\text{ MHz}$, $f_{RF2} = 900\text{ MHz}$, $f_{LO} = 1103\text{ MHz}$, each RF tone at 0 dBm		80		dBm
Input 1 dB Compression Point (IP1dB) ¹	Exceeding 20 dBm RF power results in damage to the device		25		dBm
LO-to-IF Leakage	Unfiltered IF output		-15		dBm
LO-to-RF Leakage			-40		dBm
RF-to-IF Isolation			-47		dBc
IF/2 Spurious	0 dBm input power		-75		dBc
IF/3 Spurious	0 dBm input power		-72		dBc
POWER SUPPLY					
Positive Supply Voltage		4.5	5	5.5	V
Total Quiescent Current	$V_S = 5\text{ V}$		97		mA

¹ Exceeding 20 dBm RF power results in damage to the device.

3.3 V PERFORMANCE

$V_S = 3.3\text{ V}$, $I_S = 56\text{ mA}$, $T_A = 25^\circ\text{C}$, $f_{RF} = 900\text{ MHz}$, $f_{LO} = 1103\text{ MHz}$, LO power = 0 dBm, $R_9 = 226\ \Omega$, VGS0 = VGS1 = 0 V, and $Z_O = 50\ \Omega$, unless otherwise noted.

Table 4.

Parameter	Conditions	Min	Typ	Max	Unit
DYNAMIC PERFORMANCE					
Power Conversion Loss	Including 4:1 IF port transformer and PCB loss		7.3		dB
Voltage Conversion Loss	$Z_{SOURCE} = 50\ \Omega$, differential $Z_{LOAD} = 200\ \Omega$ differential		1		dB
SSB Noise Figure			8.1		dB
Input Third-Order Intercept (IIP3)	$f_{RF1} = 1949.5\text{ MHz}$, $f_{RF2} = 1950.5\text{ MHz}$, $f_{LO} = 1750\text{ MHz}$, each RF tone at -10 dBm		28.5		dBm
Input Second-Order Intercept (IIP2)	$f_{RF1} = 1950\text{ MHz}$, $f_{RF2} = 1900\text{ MHz}$, $f_{LO} = 1750\text{ MHz}$, each RF tone at -10 dBm		75		dBm
POWER INTERFACE					
Supply Voltage		3.0	3.3	3.6	V
Quiescent Current	Resistor programmable		56		mA
Power-Down Current	Device disabled		150		μA

ABSOLUTE MAXIMUM RATINGS

Table 5.

Parameter	Rating
Supply Voltage, V_s	5.5 V
RF Input Level	20 dBm
LO Input Level	13 dBm
IFOP, IFON Bias Voltage	6.0 V
VGS0, VGS1, LOSW, PWDN	5.5 V
Internal Power Dissipation	1.2 W
θ_{JA}	25°C/W
Maximum Junction Temperature	150°C
Operating Temperature Range	-40°C to +85°C
Storage Temperature Range	-65°C to +150°C
Lead Temperature Range (Soldering, 60 sec)	260°C

Stresses above those listed under Absolute Maximum Ratings may cause permanent damage to the device. This is a stress rating only; functional operation of the device at these or any other conditions above those indicated in the operational section of this specification is not implied. Exposure to absolute maximum rating conditions for extended periods may affect device reliability.

ESD CAUTION



ESD (electrostatic discharge) sensitive device. Charged devices and circuit boards can discharge without detection. Although this product features patented or proprietary protection circuitry, damage may occur on devices subjected to high energy ESD. Therefore, proper ESD precautions should be taken to avoid performance degradation or loss of functionality.

PIN CONFIGURATION AND FUNCTION DESCRIPTIONS

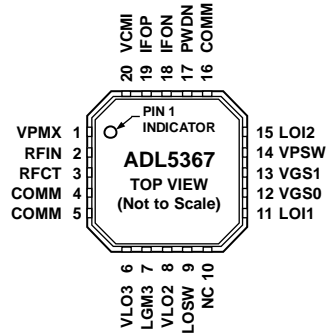

NOTES
 1. NC = NO CONNECT.
 2. EXPOSED PAD. MUST BE SOLDERED TO GROUND.

08083-002

Figure 2. Pin Configuration

Table 6. Pin Function Descriptions

Pin No.	Mnemonic	Description
1	VPMX	Positive Supply Voltage for IF Amplifier.
2	RFIN	RF Input. This pin must be ac-coupled.
3	RFCT	RF Balun Center Tap (AC Ground).
4, 5, 16	COMM	Device Common (DC Ground).
6, 8	VLO3, VLO2	Positive Supply Voltages for LO Amplifier.
7	LGM3	LO Amplifier Bias Control.
9	LOSW	LO Switch. LOI1 selected for 0 V, or LOI2 selected for 3 V.
10	NC	No Connect.
11, 15	LOI1, LOI2	LO Inputs. This pin must be ac-coupled.
12, 13	VGS0, VGS1	Mixer Gate Bias Controls. 3 V logic. Ground these pins for nominal setting.
14	VPSW	Positive Supply Voltage for LO Switch.
17	PWDN	Power Down. Connect this pin to ground for normal operation or connect this pin to 3.0 V for disable mode.
18, 19	IFON, IFOP	Differential IF Outputs.
20	VCM1	No Connect. This pin can be grounded.
	EPAD (EP)	Exposed pad must be soldered to ground.

TYPICAL PERFORMANCE CHARACTERISTICS

5 V PERFORMANCE

$V_S = 5\text{ V}$, $I_S = 97\text{ mA}$, $T_A = 25^\circ\text{C}$, $f_{RF} = 900\text{ MHz}$, $f_{LO} = 1103\text{ MHz}$, LO power = 0 dBm, VGS0 = VGS1 = 0 V, and $Z_O = 50\ \Omega$, unless otherwise noted.

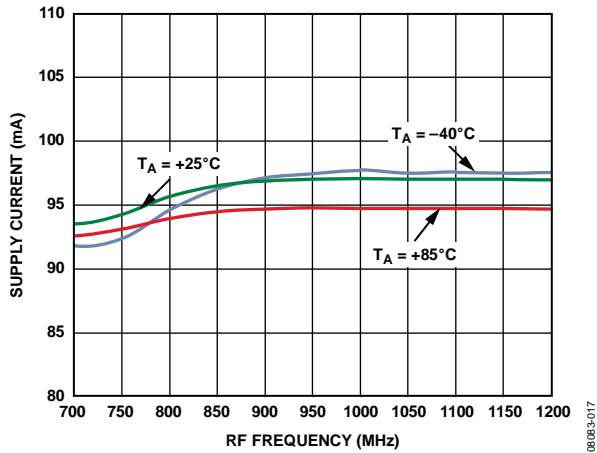

Figure 3. Supply Current vs. RF Frequency

08083-017

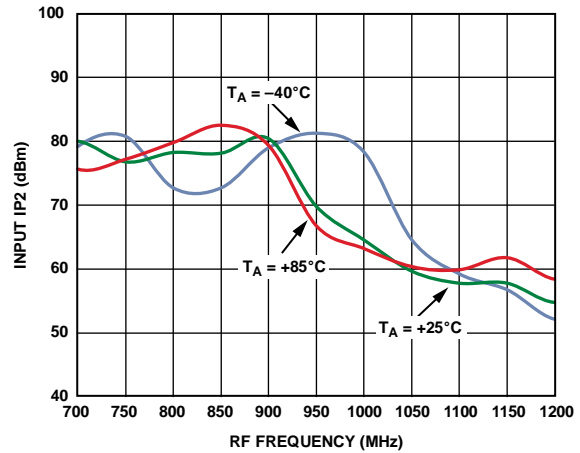

Figure 6. Input IP2 vs. RF Frequency

08083-023

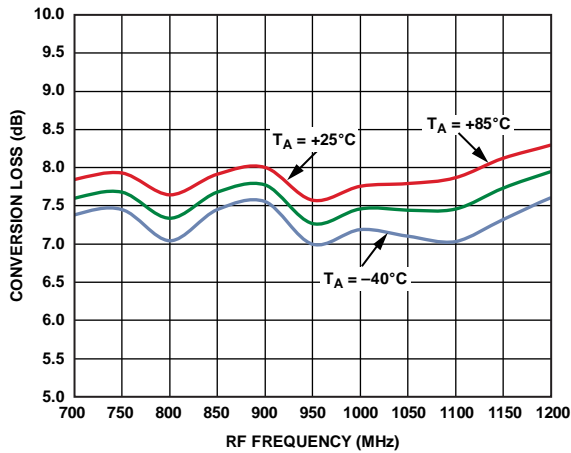

Figure 4. Power Conversion Loss vs. RF Frequency

08083-035

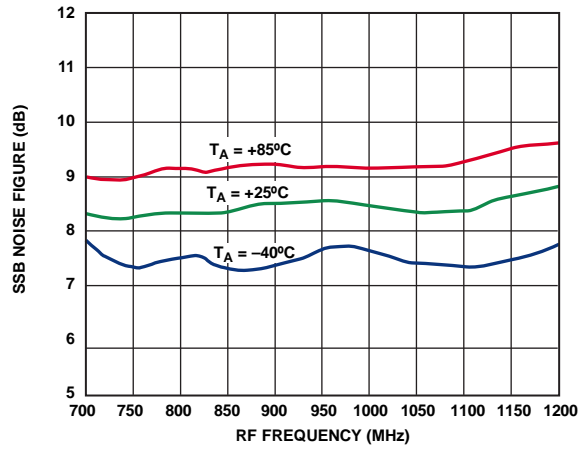

Figure 7. SSB Noise Figure vs. RF Frequency

08083-011

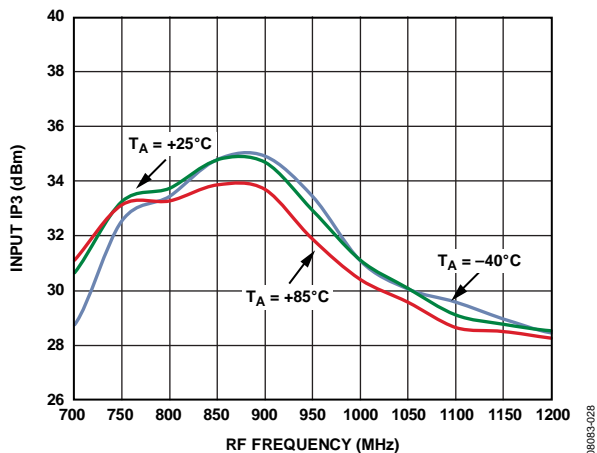

Figure 5. Input IP3 vs. RF Frequency

08083-028

$V_S = 5\text{ V}$, $I_S = 97\text{ mA}$, $T_A = 25^\circ\text{C}$, $f_{RF} = 900\text{ MHz}$, $f_{LO} = 1103\text{ MHz}$, LO power = 0 dBm, $V_{GS0} = V_{GS1} = 0\text{ V}$, and $Z_O = 50\ \Omega$, unless otherwise noted.

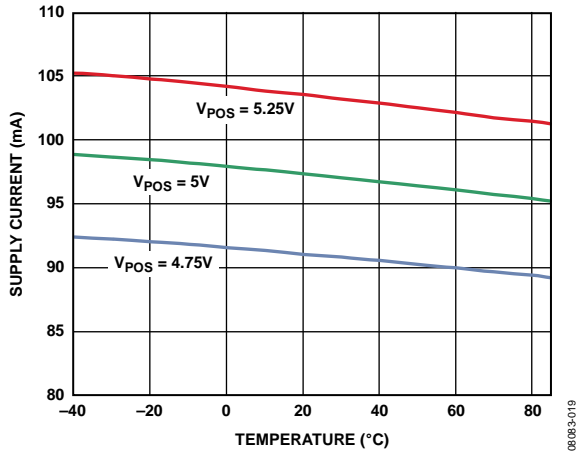

Figure 8. Supply Current vs. Temperature

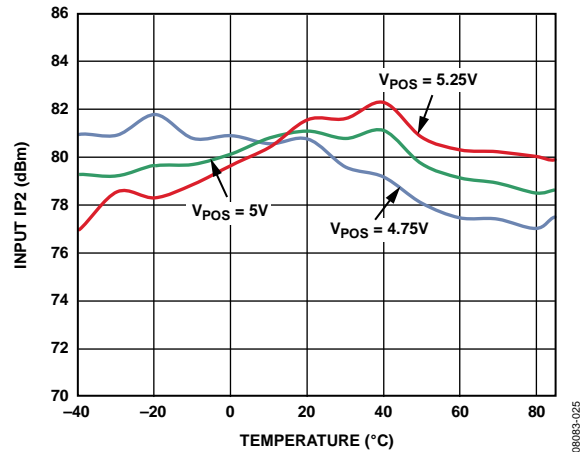

Figure 11. Input IP2 vs. Temperature

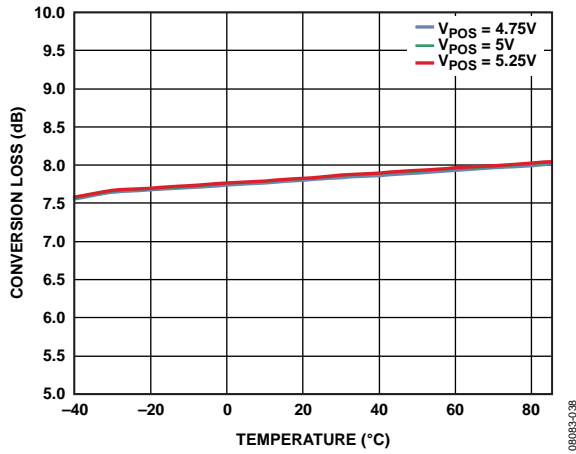

Figure 9. Power Conversion Loss vs. Temperature

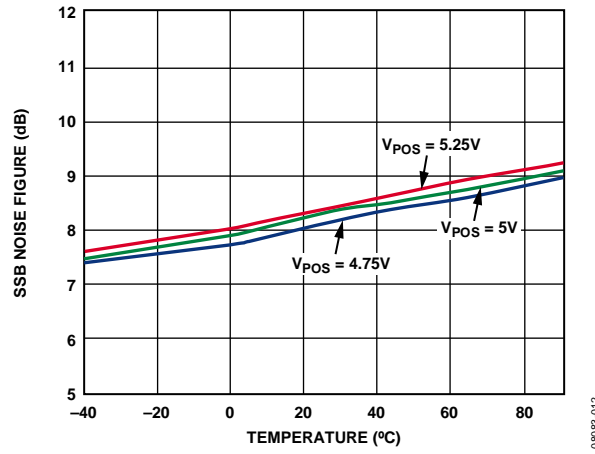

Figure 12. SSB Noise Figure vs. Temperature

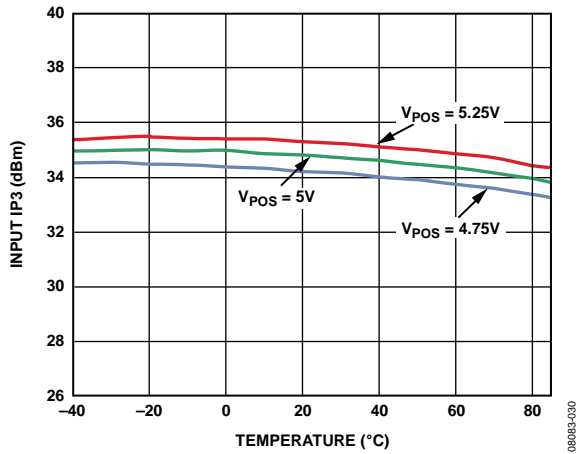

Figure 10. Input IP3 vs. Temperature

$V_S = 5\text{ V}$, $I_S = 97\text{ mA}$, $T_A = 25^\circ\text{C}$, $f_{RF} = 900\text{ MHz}$, $f_{LO} = 1103\text{ MHz}$, LO power = 0 dBm, $V_{GS0} = V_{GS1} = 0\text{ V}$, and $Z_O = 50\ \Omega$, unless otherwise noted.

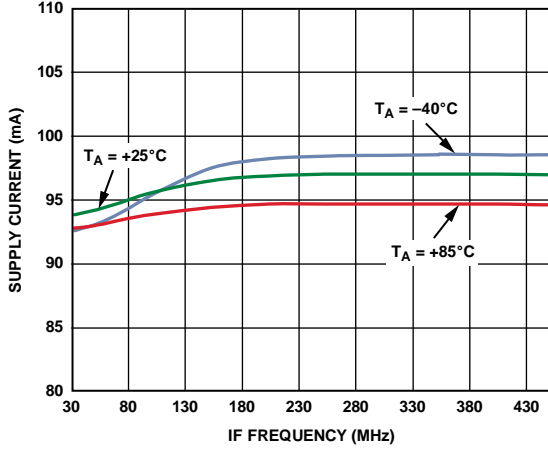

Figure 13. Supply Current vs. IF Frequency

08083-016

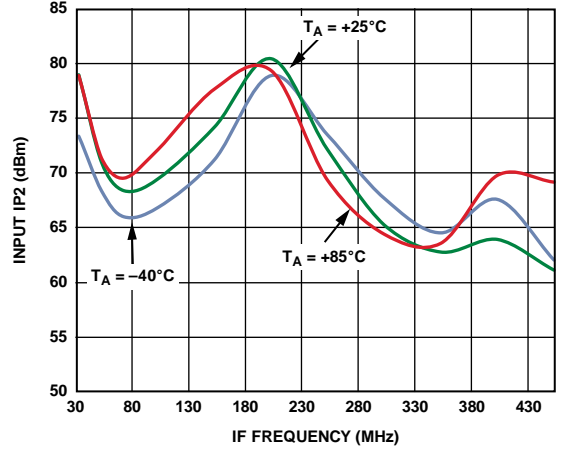

Figure 16. Input IP2 vs. IF Frequency

08083-021

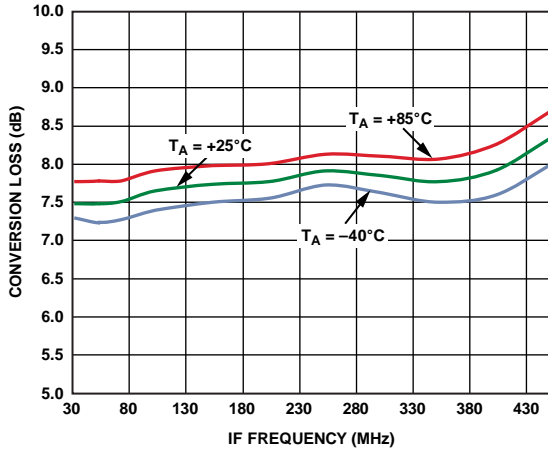

Figure 14. Power Conversion Loss vs. IF Frequency

08083-033

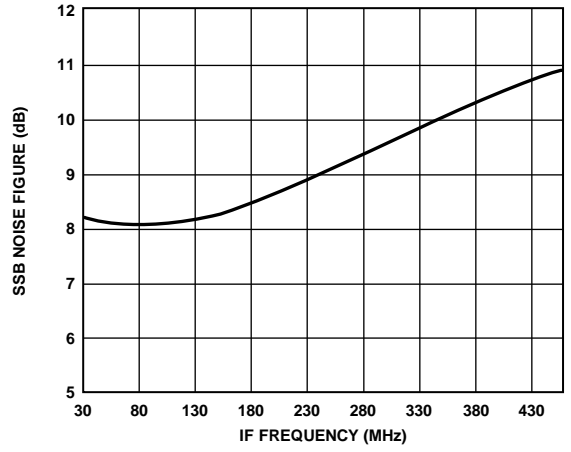

Figure 17. SSB Noise Figure vs. IF Frequency

08083-010

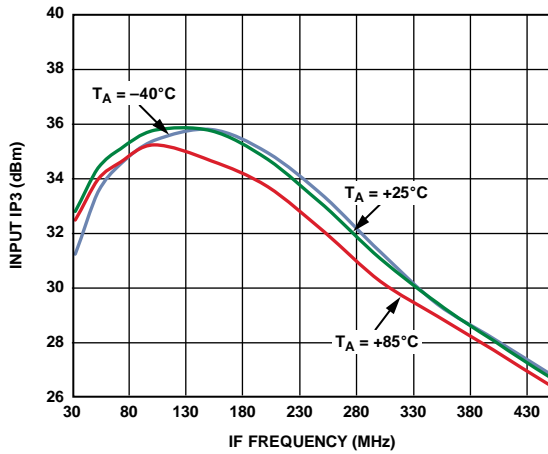

Figure 15. Input IP3 vs. IF Frequency

08083-028

$V_S = 5\text{ V}$, $I_S = 97\text{ mA}$, $T_A = 25^\circ\text{C}$, $f_{RF} = 900\text{ MHz}$, $f_{LO} = 1103\text{ MHz}$, LO power = 0 dBm, $V_{GS0} = V_{GS1} = 0\text{ V}$, and $Z_O = 50\ \Omega$, unless otherwise noted.

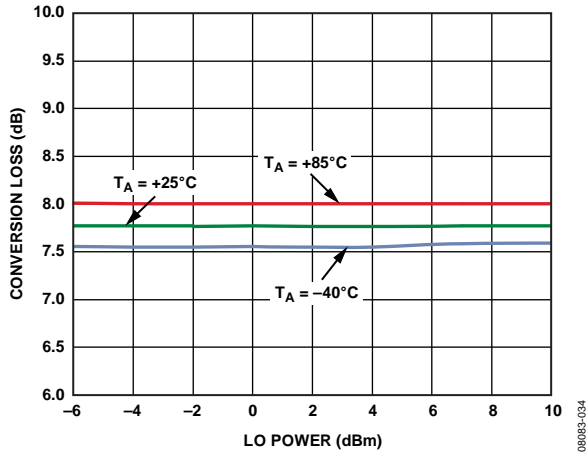

Figure 18. Power Conversion Loss vs. LO Power

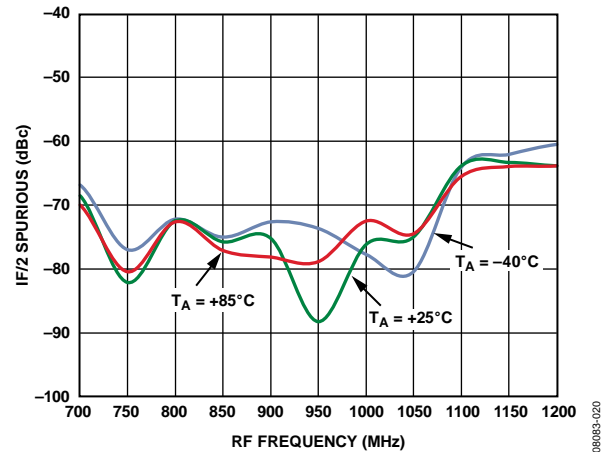

Figure 21. IF/2 Spurious vs. RF Frequency

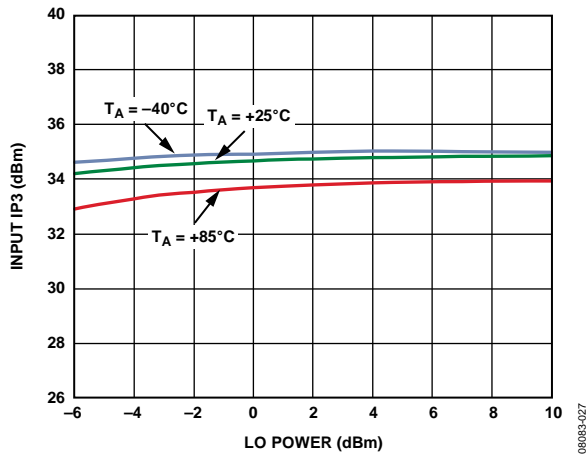

Figure 19. Input IP3 vs. LO Power

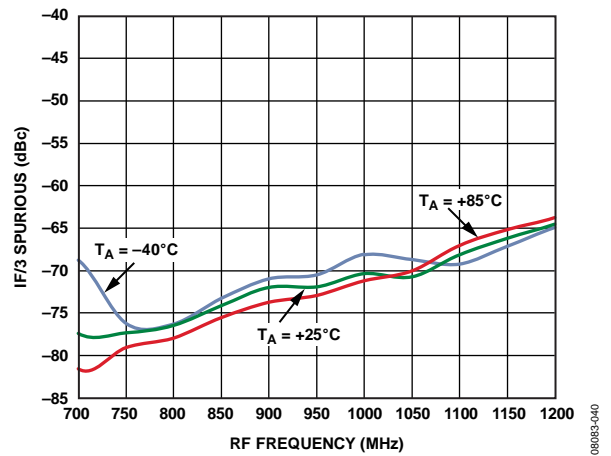

Figure 22. IF/3 Spurious vs. RF Frequency

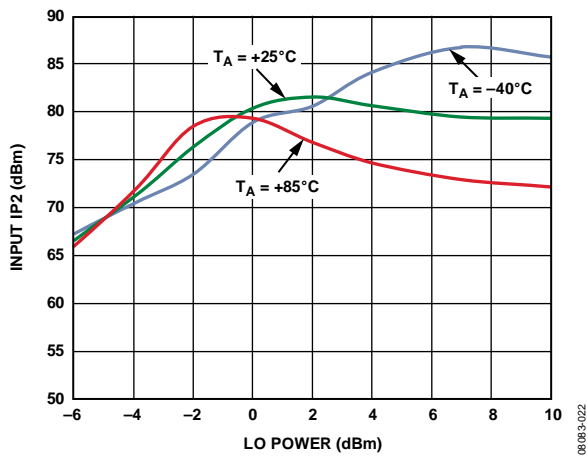

Figure 20. Input IP2 vs. LO Power

$V_S = 5\text{ V}$, $I_S = 97\text{ mA}$, $T_A = 25^\circ\text{C}$, $f_{RF} = 900\text{ MHz}$, $f_{LO} = 1103\text{ MHz}$, LO power = 0 dBm, $V_{GS0} = V_{GS1} = 0\text{ V}$, and $Z_O = 50\ \Omega$, unless otherwise noted.

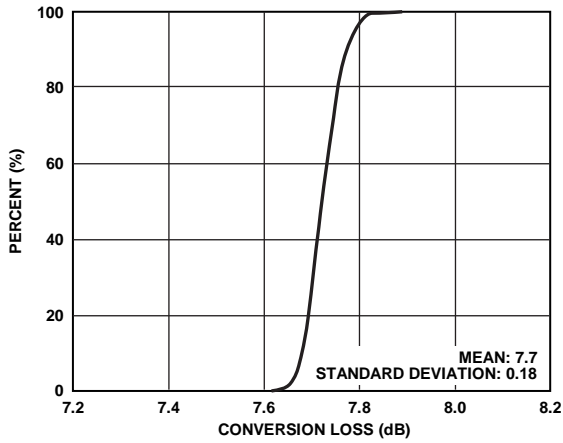

Figure 23. Conversion Loss Distribution

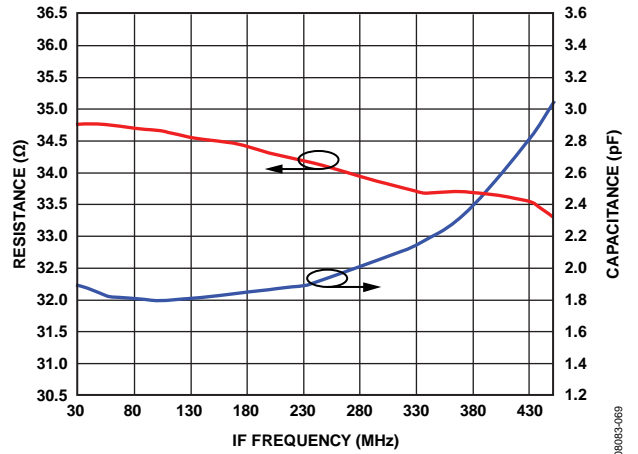

Figure 26. IF Port Return Loss

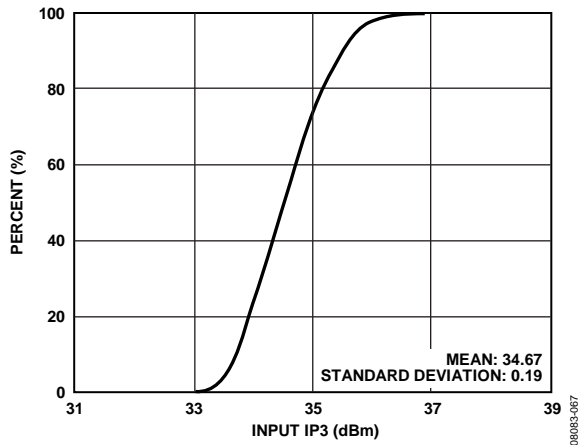

Figure 24. Input IP3 Distribution

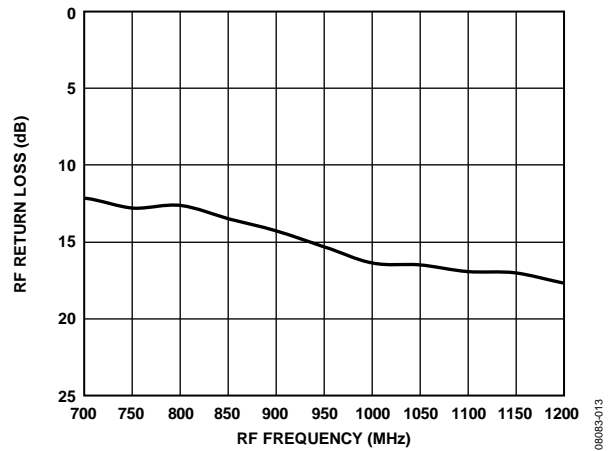

Figure 27. RF Port Return Loss, Fixed IF

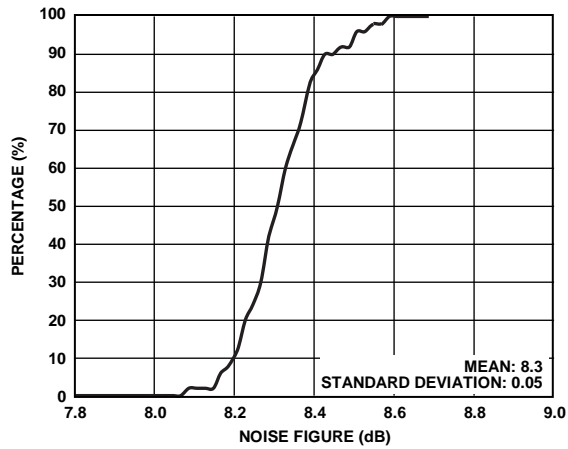

Figure 25. SSB Noise Figure Distribution

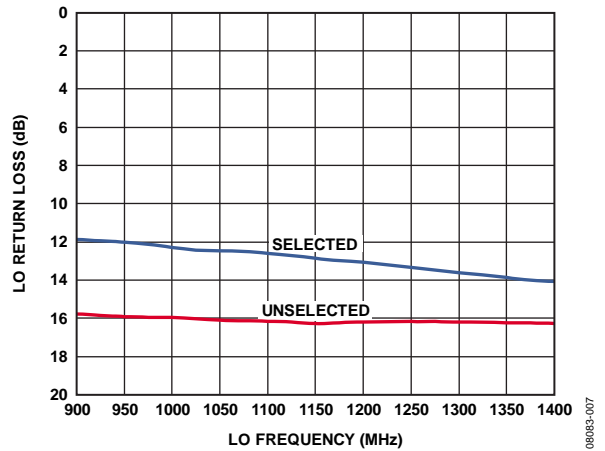

Figure 28. LO Return Loss, Selected and Unselected

$V_S = 5\text{ V}$, $I_S = 97\text{ mA}$, $T_A = 25^\circ\text{C}$, $f_{RF} = 900\text{ MHz}$, $f_{LO} = 1103\text{ MHz}$, LO power = 0 dBm, $V_{GS0} = V_{GS1} = 0\text{ V}$, and $Z_O = 50\ \Omega$, unless otherwise noted.

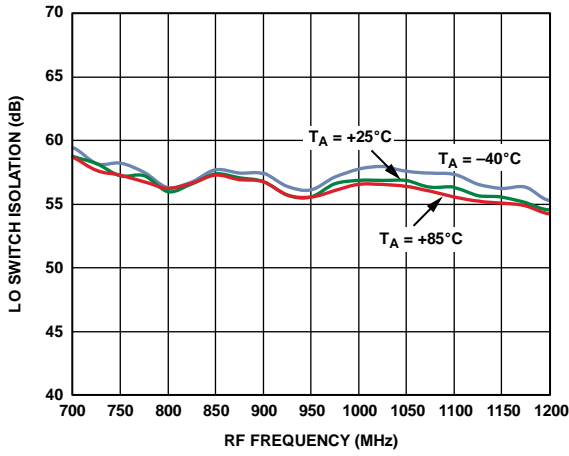

Figure 29. LO Switch Isolation vs. RF Frequency

08083-069

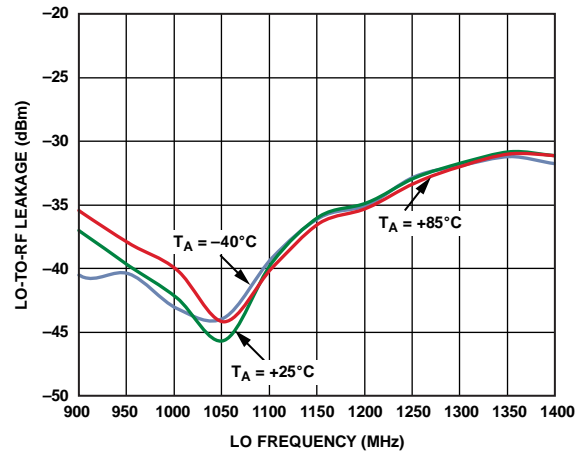

Figure 32. LO-to-RF Leakage vs. LO Frequency

08083-032

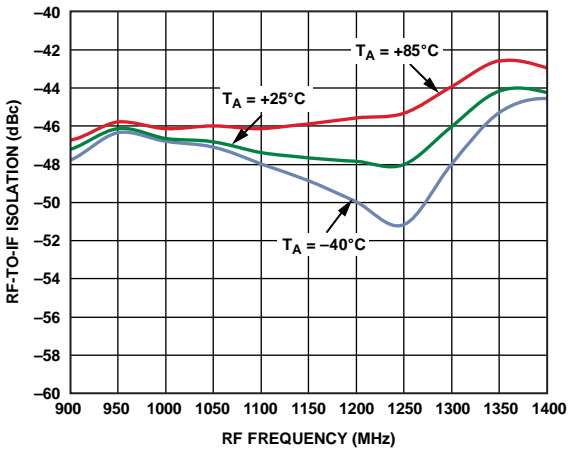

Figure 30. RF-to-IF Isolation vs. RF Frequency

08083-039

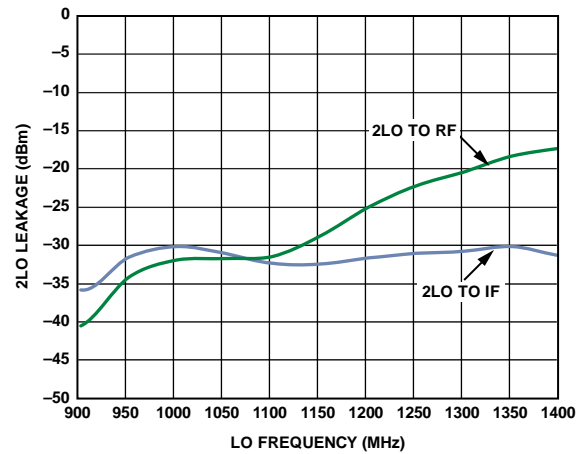

Figure 33. 2LO Leakage vs. LO Frequency

08083-014

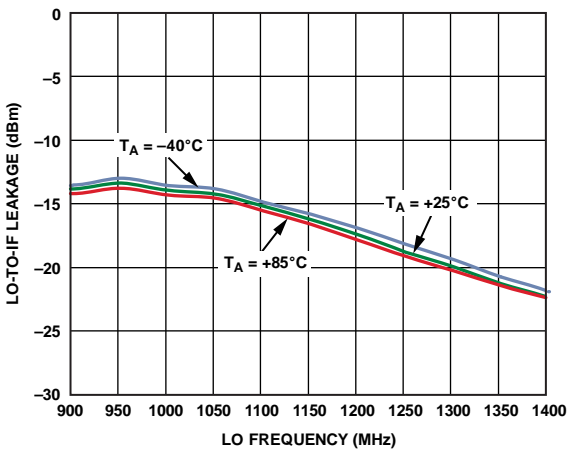

Figure 31. LO-to-IF Leakage vs. LO Frequency

08083-031

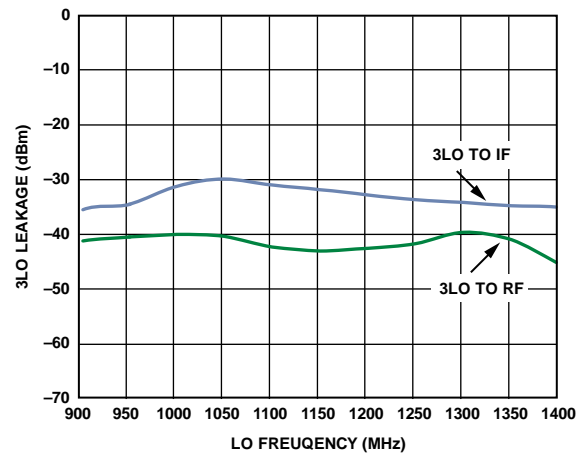

Figure 34. 3LO Leakage vs. LO Frequency

08083-015

$V_S = 5\text{ V}$, $I_S = 97\text{ mA}$, $T_A = 25^\circ\text{C}$, $f_{RF} = 900\text{ MHz}$, $f_{LO} = 1103\text{ MHz}$, LO power = 0 dBm, $V_{GS0} = V_{GS1} = 0\text{ V}$, and $Z_O = 50\ \Omega$, unless otherwise noted.

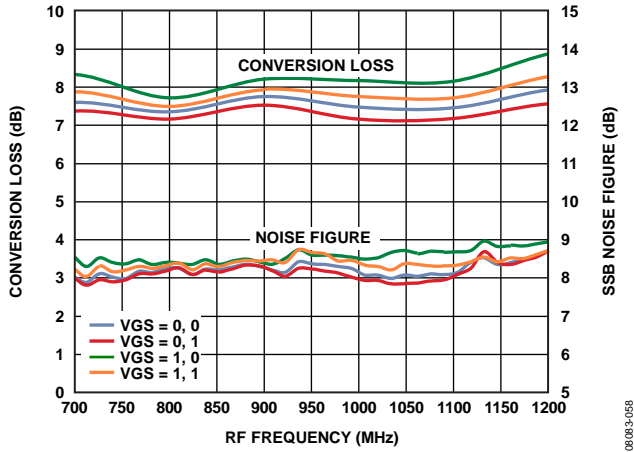

Figure 35. Power Conversion Loss and SSB Noise Figure vs. RF Frequency

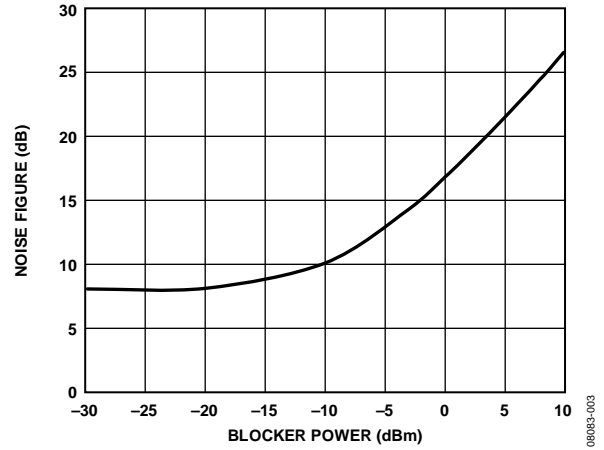

Figure 38. SSB Noise Figure vs. 10 MHz Offset Blocker Level

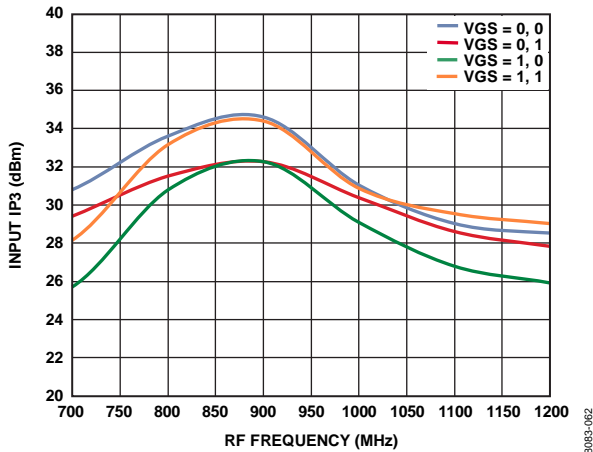

Figure 36. Input IP3 vs. RF Frequency

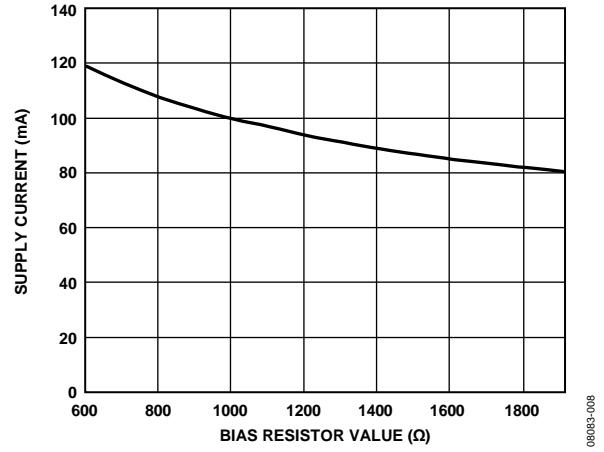

Figure 39. LO Supply Current vs. LO Bias Resistor Value

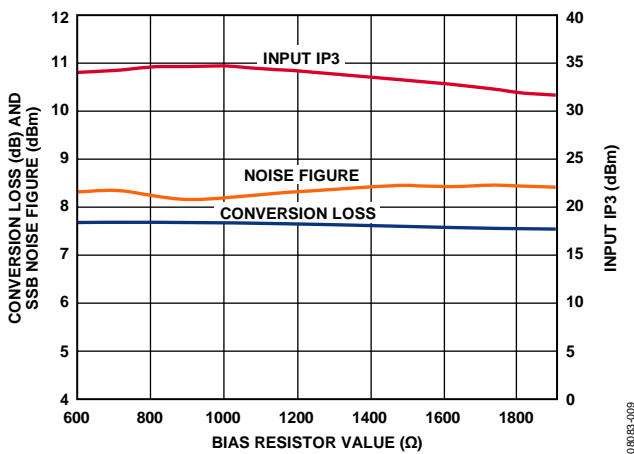

Figure 37. Power Conversion Loss, SSB Noise Figure, and Input IP3 vs. LO Bias Resistor Value

3.3 V PERFORMANCE

$V_S = 3.3\text{ V}$, $I_S = 56\text{ mA}$, $T_A = 25^\circ\text{C}$, $f_{RF} = 900\text{ MHz}$, $f_{LO} = 1103\text{ MHz}$, LO power = 0 dBm, $R_9 = 226\ \Omega$, $V_{GS0} = V_{GS1} = 0\text{ V}$, and $Z_O = 50\ \Omega$, unless otherwise noted.

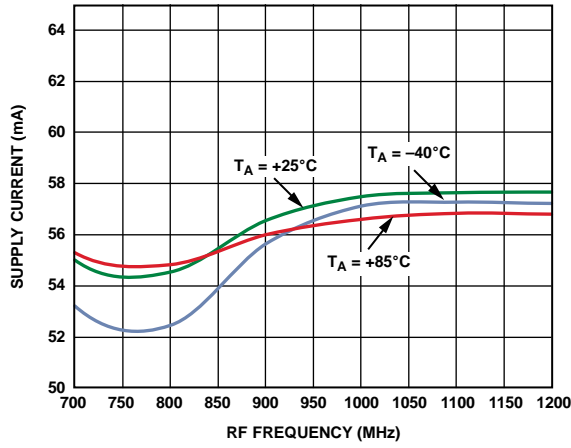

Figure 40. Supply Current vs. RF Frequency at 3.3 V

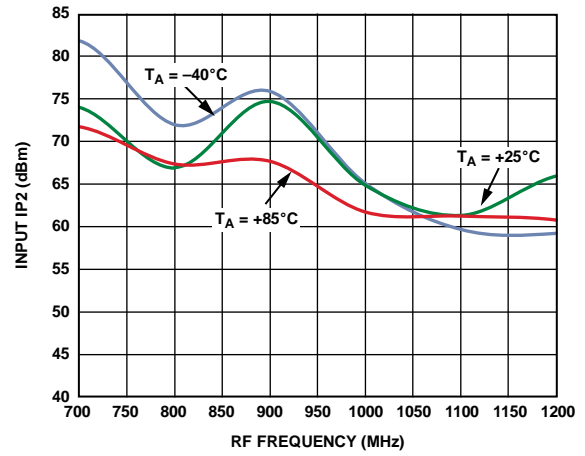

Figure 43. Input IP2 vs. RF Frequency at 3.3 V

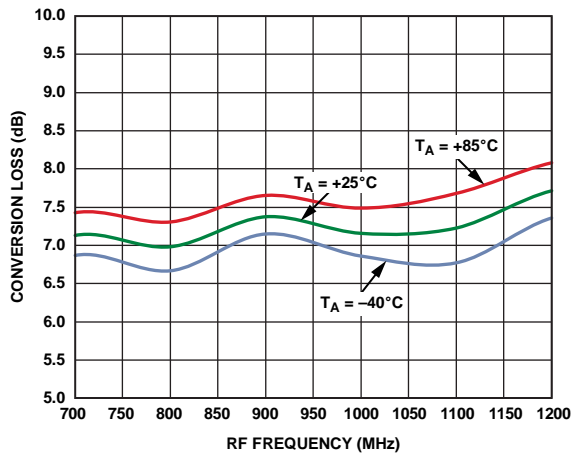

Figure 41. Power Conversion Loss vs. RF Frequency at 3.3 V

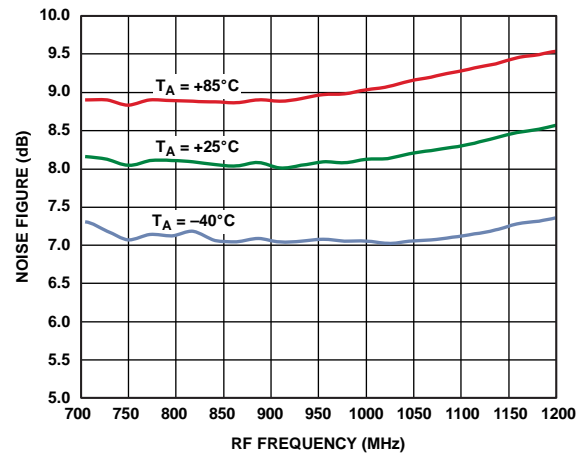

Figure 44. SSB Noise Figure vs. RF Frequency at 3.3 V

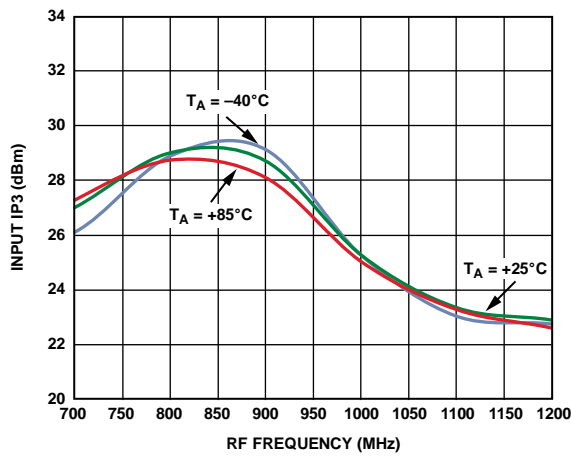

Figure 42. Input IP3 vs. RF Frequency at 3.3 V

09083-018

09083-024

09083-036

09083-064

09083-029

UPCONVERSION

$T_A = 25^\circ\text{C}$, $f_{IF} = 153\text{ MHz}$, $f_{LO} = 1697\text{ MHz}$, LO power = 0 dBm, RF power = 0 dBm, $V_{GS0} = V_{GS1} = 0\text{ V}$, and $Z_O = 50\ \Omega$, unless otherwise noted.

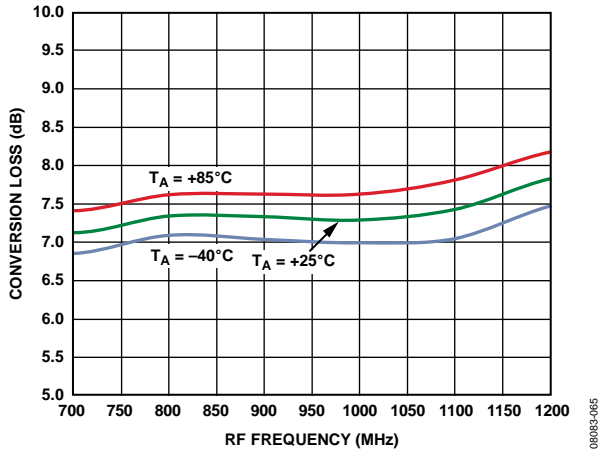

Figure 45. Power Conversion Loss vs. RF Frequency, $V_S = 5\text{ V}$, Upconversion

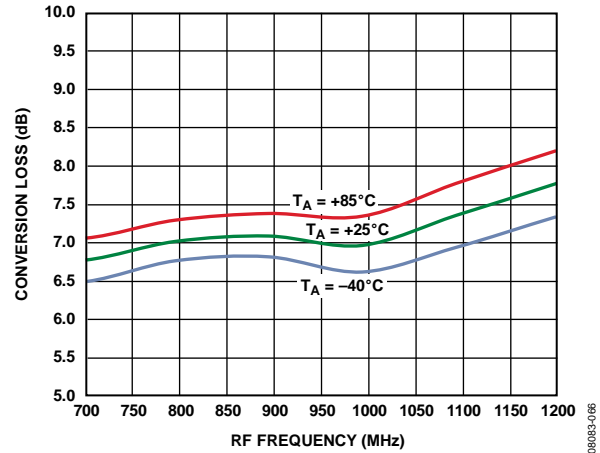

Figure 47. Power Conversion Loss vs. RF Frequency at 3.3 V, Upconversion

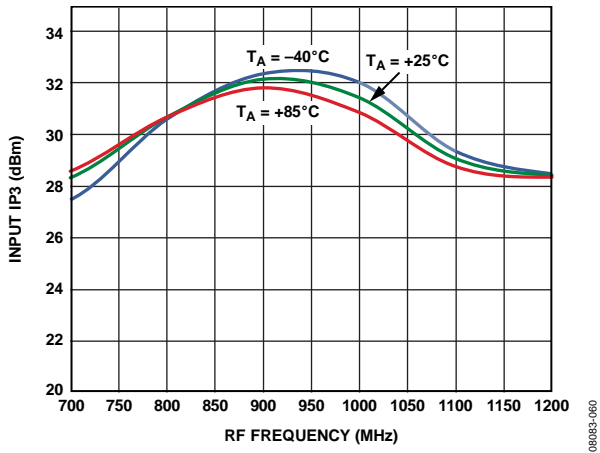

Figure 46. Input IP3 vs. RF Frequency, $V_S = 5\text{ V}$, Upconversion

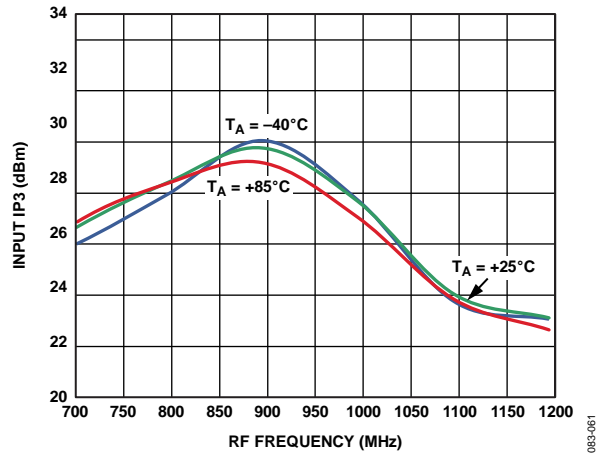

Figure 48. Input IP3 vs. RF Frequency at 3.3 V, Upconversion

SPUR TABLES

All spur tables are $(N \times f_{RF}) - (M \times f_{LO})$ and were measured using the standard evaluation board. Mixer spurious products are measured in dBc from the IF output power level. Data was measured only for frequencies less than 6 GHz. Typical noise floor of the measurement system = -100 dBm.

5 V Performance

$V_S = 5\text{ V}$, $I_S = 97\text{ mA}$, $T_A = 25^\circ\text{C}$, $f_{RF} = 900\text{ MHz}$, $f_{LO} = 1103\text{ MHz}$, LO power = 0 dBm, RF power = 0 dBm, VGS0 = VGS1 = 0 V, and $Z_O = 50\ \Omega$, unless otherwise noted.

		M														
		0	1	2	3	4	5	6	7	8	9	10	11	12	13	14
N	0		-7.8	-24.6	-35.7	-53.0	-47.4									
	1	-39.7	0.0	-45.0	-27.5	-53.0	-54.4	-71.8								
	2	-84.6	-68.8	-77.4	-72.8	-80.2	-80.9	-87.8	-96.8							
	3	<-100	-78.6	-95.5	-75.9	-97.9	-91.7	<-100	<-100							
	4	<-100	<-100	<-100	<-100	<-100	<-100	<-100	<-100	<-100						
	5	<-100	<-100	<-100	<-100	<-100	<-100	<-100	<-100	<-100	<-100					
	6	<-100	<-100	<-100	<-100	<-100	<-100	<-100	<-100	<-100	<-100	<-100				
	7		<-100	<-100	<-100	<-100	<-100	<-100	<-100	<-100	<-100	<-100	<-100			
	8			<-100	<-100	<-100	<-100	<-100	<-100	<-100	<-100	<-100	<-100	<-100		
	9			<-100	<-100	<-100	<-100	<-100	<-100	<-100	<-100	<-100	<-100	<-100	<-100	
	10				<-100	<-100	<-100	<-100	<-100	<-100	<-100	<-100	<-100	<-100	<-100	<-100
	11					<-100	<-100	<-100	<-100	<-100	<-100	<-100	<-100	<-100	<-100	<-100
	12						<-100	<-100	<-100	<-100	<-100	<-100	<-100	<-100	<-100	<-100
	13							<-100	<-100	<-100	<-100	<-100	<-100	<-100	<-100	<-100
	14								<-100	<-100	<-100	<-100	<-100	<-100	<-100	<-100
15									<-100	<-100	<-100	<-100	<-100	<-100	<-100	

3.3 V Performance

$V_S = 3.3\text{ V}$, $I_S = 56\text{ mA}$, $T_A = 25^\circ\text{C}$, $f_{RF} = 900\text{ MHz}$, $f_{LO} = 1103\text{ MHz}$, LO power = 0 dBm, RF power = 0 dBm, $R_9 = 226\ \Omega$, VGS0 = VGS1 = 0 V, and $Z_O = 50\ \Omega$, unless otherwise noted.

		M														
		0	1	2	3	4	5	6	7	8	9	10	11	12	13	14
N	0		-12.6	-28.8	-40.6	-43.0	-59.6									
	1	-40.5	0.0	-42.7	-27.1	-53.2	-50.7	-71.8								
	2	-78.6	-59.5	-64.8	-68.0	-65.9	-73.0	-75.4	-89.4							
	3	-93.9	-66.3	-90.1	-63.0	-90.5	-77.8	-96.4	-95.6							
	4	<-100	<-100	-95.6	-95.5	-97.0	<-100	<-100	<-100	<-100						
	5	<-100	<-100	<-100	<-100	<-100	-98.9	<-100	<-100	<-100	<-100					
	6	<-100	<-100	<-100	<-100	<-100	<-100	<-100	<-100	<-100	<-100	<-100				
	7		<-100	<-100	<-100	<-100	<-100	<-100	<-100	<-100	<-100	<-100	<-100			
	8			<-100	<-100	<-100	<-100	<-100	<-100	<-100	<-100	<-100	<-100	<-100		
	9			<-100	<-100	<-100	<-100	<-100	<-100	<-100	<-100	<-100	<-100	<-100	<-100	
	10				<-100	<-100	<-100	<-100	<-100	<-100	<-100	<-100	<-100	<-100	<-100	<-100
	11					<-100	<-100	<-100	<-100	<-100	<-100	<-100	<-100	<-100	<-100	<-100
	12						<-100	<-100	<-100	<-100	<-100	<-100	<-100	<-100	<-100	<-100
	13							<-100	<-100	<-100	<-100	<-100	<-100	<-100	<-100	<-100
	14								<-100	<-100	<-100	<-100	<-100	<-100	<-100	<-100
15									<-100	<-100	<-100	<-100	<-100	<-100	<-100	

ADL5367

[查询"ADL5367"供应商](#)

The performance of this amplifier is critical in achieving a high intercept passive mixer without degrading the noise floor of the system. This is a critical requirement in an interferer rich environment, such as cellular infrastructure, where blocking interferers can limit mixer performance. The bandwidth of the intermodulation performance is somewhat influenced by the current in the LO amplifier chain. For dc current sensitive applications, it is permissible to reduce the current in the LO amplifier by raising the value of the external bias control resistor. For dc current critical applications, the LO chain can operate with a supply voltage as low as 3.3 V, resulting in substantial dc power savings.

In addition, when operating with supply voltages below 3.6 V, the ADL5367 has a power-down mode that permits the dc current to drop to $<200 \mu\text{A}$.

All of the logic inputs are designed to work with any logic family that provides a Logic 0 input level of less than 0.4 V and a Logic 1 input level that exceeds 1.4 V. All logic inputs are high impedance up to Logic 1 levels of 3.3 V. At levels exceeding 3.3 V, protection circuitry permits operation up to 5.5 V, although a small bias current is drawn.

APPLICATIONS INFORMATION

BASIC CONNECTIONS

The ADL5367 mixer is designed to upconvert or downconvert between radio frequencies (RF) from 500 MHz to 1700 MHz and intermediate frequencies (IF) from dc to 450 MHz. Figure 50 depicts the basic connections of the mixer. It is recommended to ac-couple the RF and LO input ports to prevent non-zero dc voltages from damaging the RF balun or LO input circuit. The RFIN capacitor value of 8 pF is recommended to provide the optimized RF input return loss for the desired frequency band.

For upconversion, the IF input, Pin 18 (IFON) and Pin 19 (IFOP), must be driven differentially or using a 1:1 ratio transformer for single ended operation. An 8 pF capacitor is recommended for the RF output, Pin 2 (RFIN).

IF PORT

The real part of the output impedance is approximately 50 Ω , as seen in Figure 26, which matches many commonly used SAW filters without the need for a transformer. This results in a voltage conversion loss that is approximately the same as the power conversion loss, as shown in Table 3.

BIAS RESISTOR SELECTION

An external resistor, $R_{BIAS\ LO}$, is used to adjust the bias current of the integrated amplifiers at the LO terminals. It is necessary to have a sufficient amount of current to bias the internal LO amplifier to optimize dc current vs. optimum IIP3 performance. Figure 37 and Figure 39 provide the reference for the bias resistor selection when lower power consumption is considered at the expense of conversion gain and IP3 performance.

MIXER VGS CONTROL DAC

The ADL5367 features two logic control pins, Pin 12 (VGS0) and Pin 13 (VGS1), that allow programmability for internal gate-to-source voltages for optimizing mixer performance over desired frequency bands. The evaluation board defaults both VGS0 and VGS1 to ground. Power conversion loss, NF, and IIP3 can be optimized, as shown in Figure 35 and Figure 36.

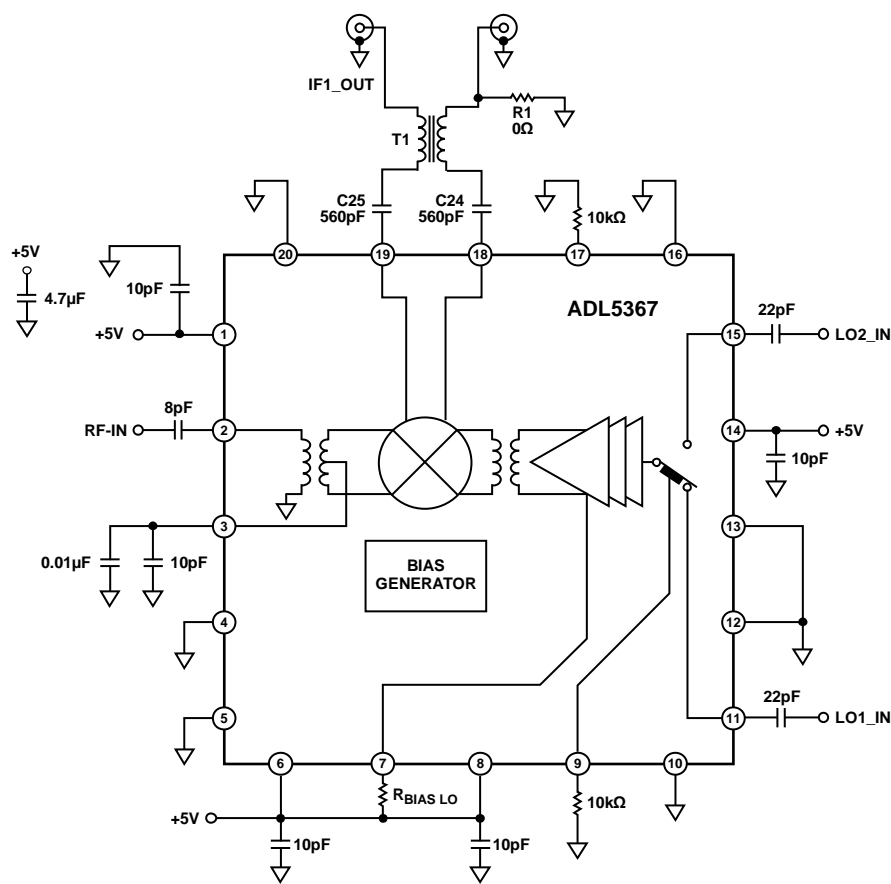

Figure 50. Typical Application Circuit

Table 7. Evaluation Board Configuration

Components	Description	Default Conditions
C2, C6, C8, C20, C21	Power Supply Decoupling. Nominal supply decoupling consists of a 10 μ F capacitor to ground in parallel with a 10 pF capacitor to ground positioned as close to the device as possible.	C2 = 10 μ F (Size 0603), C6, C8, C20, C21 = 10 pF (Size 0402)
C1, C4, C5	RF Input Interface. The input channels are ac-coupled through C1. C4 and C5 provide bypassing for the center taps of the RF input baluns.	C1 = 3 pF (Size 0402), C4 = 10 pF (Size 0402), C5 = 0.01 μ F (Size 0402)
T1, R1, C24, C25	IF Output Interface. T1 is a 1:1 impedance transformer used to provide a single-ended IF output interface. Remove R1 for balanced output operation. C24 and C25 are used to block the dc bias at the IF ports.	T1 = TC1-1-13M+ (Mini-Circuits), R1 = 0 Ω (Size 0402), C24, C25 = 560 pF (Size 0402)
C10, C12, R4	LO Interface. C10 and C12 provide ac coupling for the LO1_IN and LO2_IN local oscillator inputs. LOSEL selects the appropriate LO input for both mixer cores. R4 provides a pull-down to ensure that LO1_IN is enabled when the LOSEL test point is logic low. LO2_IN is enabled when LOSEL is pulled to logic high.	C10, C12 = 22 pF (Size 0402), R4 = 10 k Ω (Size 0402)
R21	PWDN Interface. R21 pulls the PWDN logic low and enables the device. The PWR_UP test point allows the PWDN interface to be exercised using the an external logic generator. Grounding the PWDN pin for nominal operation is allowed. Using the PWDN pin when supply voltages exceed 3.3 V is not allowed.	R21 = 10 k Ω (Size 0402)
C22, L3, R9, R14, R22, R23, VGS0, VGS1	Bias Control. R22 and R23 form a voltage divider to provide 3 V for logic control, bypassed to ground through C22. VGS0 and VGS1 jumpers provide programmability at the VGS0 and VGS1 pins. It is recommended to pull these two pins to ground for nominal operation. R9 sets the bias point for the internal LO buffers. R14 sets the bias point for the internal IF amplifier.	C22 = 1 nF (Size 0402), L3 = 0 Ω (Size 0603), R9 = 1.1 k Ω (Size 0402), R14 = 0 Ω (Size 0402), R22 = 10 k Ω (Size 0402), R23 = 15 k Ω (Size 0402), VGS0 = VGS1 = 3-pin shunt

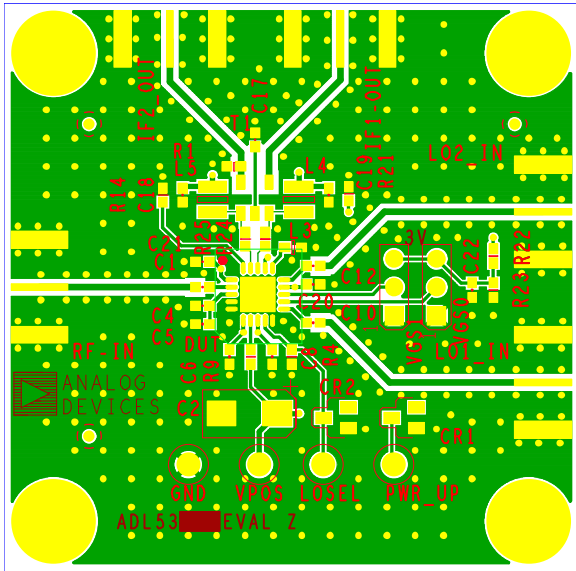

Figure 52. Evaluation Board Top Layer

08083-054

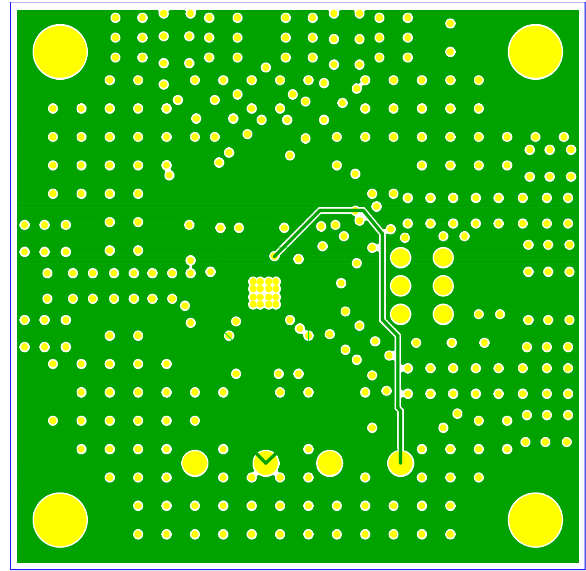

Figure 54. Evaluation Board Power Plane, Internal Layer 2

08083-056

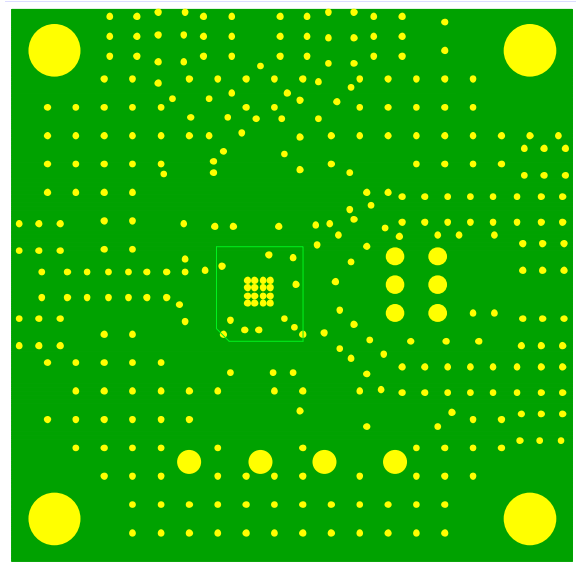

Figure 53. Evaluation Board Ground Plane, Internal Layer 1

08083-055

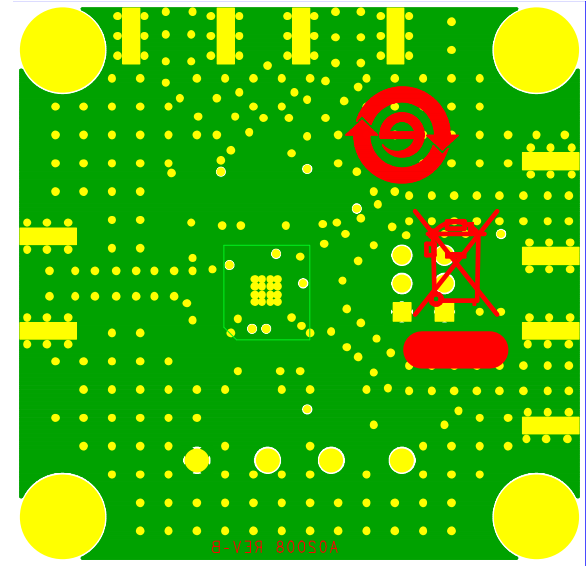
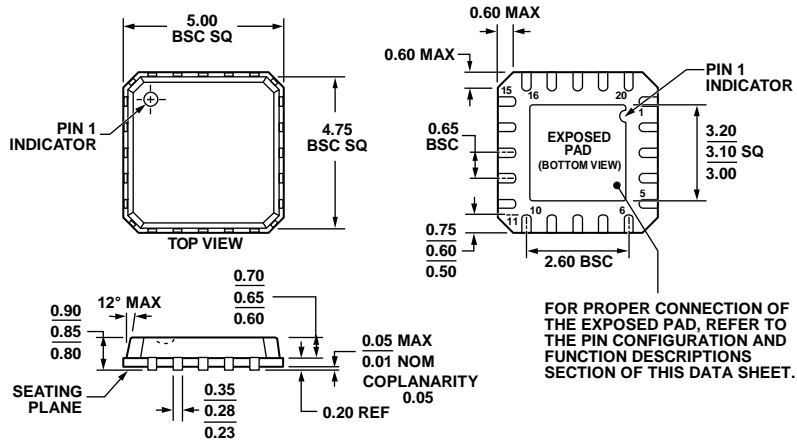

Figure 55. Evaluation Board Bottom Layer

08083-057

OUTLINE DIMENSIONS



COMPLIANT TO JEDEC STANDARDS MO-220-VHHC

Figure 56. 20-Lead Lead Frame Chip Scale Package [LFCSP_VQ]
5 mm × 5 mm Body, Very Thin Quad (CP-20-5)
Dimensions shown in millimeters

0442209-B

ORDERING GUIDE

Model	Temperature Range	Package Description	Package Option	Ordering Quantity
ADL5367ACPZ-R7 ¹	-40°C to +85°C	20-Lead Lead Frame Chip Scale Package [LFCSP_VQ], 7" Tape and Reel	CP-20-5	1,500
ADL5367-EVALZ ¹		Evaluation Board		1

¹ Z = RoHS Compliant Part.

ADL5367

[查询"ADL5367"供应商](#)

NOTES