

# LMP7721

## 3 Femtoampere Input Bias Current Precision Amplifier

### General Description

The LMP7721 is the industry's lowest guaranteed input bias current precision amplifier. The ultra low input bias current is 3 fA, with a guaranteed limit of  $\pm 20$  fA at 25°C and  $\pm 900$  fA at 85°C. This is achieved with the latest patent pending technology of input bias current cancellation amplifier circuitry. This technology also maintains the ultra low input bias current over the entire input common mode voltage range of the amplifier.

Other outstanding features, such as low voltage noise (6.5 nV/ $\sqrt{\text{Hz}}$ ), low DC offset voltage ( $\pm 150$   $\mu\text{V}$  maximum at 25°C) and low offset voltage temperature coefficient ( $-1.5$   $\mu\text{V}/^\circ\text{C}$ ), improve system sensitivity and accuracy in high precision applications. With a supply voltage range of 1.8V to 5.5V, the LMP7721 is the ideal choice for battery operated portable applications. The LMP7721 is part of the LMP® precision amplifier family.

As part of National's PowerWise® products, the LMP7721 provides the remarkably wide gain bandwidth product (GBW) of 17 MHz while consuming only 1.3 mA of current. This wide GBW along with the high open loop gain of 120 dB enables accurate signal conditioning. With these specifications, the LMP7721 has the performance to excel in a wide variety of applications such as electrochemical cell amplifiers and sensor interface circuits.

The LMP7721 is offered in an 8-pin SOIC package with a special pinout that isolates the amplifier's input from the power supply and output pins. With proper board layout techniques, the unique pinout of the LMP7721 will prevent PCB leakage current from reaching the input pins. Thus system error will be further reduced.

### Features

Unless otherwise noted, typical values at  $T_A = 25^\circ\text{C}$ ,  $V_S = 5\text{V}$ .

- Input bias current ( $V_{CM} = 1\text{V}$ )
  - max @ 25°C ±20 fA
  - max @ 85°C ±900 fA
- Offset voltage ±26  $\mu\text{V}$
- Offset voltage drift -1.5  $\mu\text{V}/^\circ\text{C}$
- DC Open loop gain 120 dB
- DC CMRR 100 dB
- Input voltage noise (at  $f = 1$  kHz) 6.5 nV/ $\sqrt{\text{Hz}}$
- THD 0.0007%
- Supply current 1.3 mA
- GBW 17 MHz
- Slew rate (falling edge) 12.76 V/ $\mu\text{s}$
- Supply voltage 1.8V to 5.5V
- Operating temperature range -40°C to 125°C
- 8-Pin SOIC

### Applications

- Photodiode amplifier
- High impedance sensor amplifier
- Ion chamber amplifier
- Electrometer amplifier
- pH electrode amplifier
- Transimpedance amplifier

### Block Diagram of a Typical Application

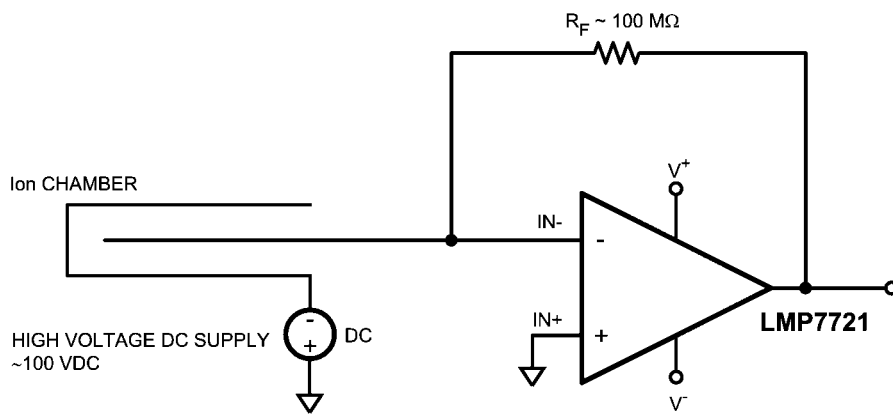

**Ion Chamber: Current to Voltage Converter**

20204084

LMP® is a registered trademark of National Semiconductor Corporation.  
 PowerWise® is a registered trademark of National Semiconductor.

**Absolute Maximum Ratings** (Note 1)

查询"LMP7721MA"供应商

If Military/Aerospace specified devices are required, please contact the National Semiconductor Sales Office/Distributors for availability and specifications.

ESD Tolerance (Note 2)	
Human Body Model	2000V
Machine Model	200V
$V_{IN}$ Differential	$\pm 0.3V$
Supply Voltage ( $V_S = V^+ - V^-$ ) (Note 10)	6.0V
Voltage on Input/Output Pins	$V^+ + 0.3V, V^- - 0.3V$
Storage Temperature Range	$-65^\circ C$ to $150^\circ C$
Junction Temperature (Note 3)	$+150^\circ C$

## Soldering Information

Infrared or Convection (20 sec)	$235^\circ C$
Wave Soldering Lead Temp. (10 sec)	$260^\circ C$

**Operating Ratings** (Note 1)

Temperature Range (Note 3)	$-40^\circ C$ to $125^\circ C$
Supply Voltage ( $V_S = V^+ - V^-$ )	
$0^\circ C \leq T_A \leq 125^\circ C$	1.8V to 5.5V
$-40^\circ C \leq T_A \leq 125^\circ C$	2.0V to 5.5V
Package Thermal Resistance ( $\theta_{JA}$ ) (Note 3)	
8-Pin SOIC	$190^\circ C/W$

**2.5V Electrical Characteristics**

Unless otherwise specified, all limits are guaranteed for  $T_A = 25^\circ C$ ,  $V^+ = 2.5V$ ,  $V^- = 0V$ ,  $V_{CM} = (V^+ + V^-)/2$ . **Boldface** limits apply at the temperature extremes.

Symbol	Parameter	Conditions	Min (Note 5)	Typ (Note 4)	Max (Note 5)	Units	
$V_{OS}$	Input Offset Voltage			$\pm 50$	$\pm 180$ <b><math>\pm 480</math></b>	$\mu V$	
TC $V_{OS}$	Input Offset Voltage Drift (Note 6)			-1.5	-4	$\mu V/^\circ C$	
$I_{BIAS}$	Input Bias Current	$V_{CM} = 1V$ (Notes 7, 8)	$25^\circ C$	$\pm 3$	$\pm 20$	fA	
			$-40^\circ C$ to $85^\circ C$		$\pm 900$		
			$-40^\circ C$ to $125^\circ C$		<b><math>\pm 5</math></b>	pA	
$I_{OS}$	Input Offset Current	$V_{CM} = 1V$ (Note 8)		6	40	fA	
CMRR	Common Mode Rejection Ratio	$0V \leq V_{CM} \leq 1.4V$	83 <b>80</b>	100		dB	
PSRR	Power Supply Rejection Ratio	$1.8V \leq V^+ \leq 5.5V$ $V^- = 0V, V_{CM} = 0$	84 <b>80</b>	92		dB	
CMVR	Input Common-Mode Voltage Range	CMRR $\geq 80$ dB CMRR $\geq 78$ dB	-0.3 <b>-0.3</b>		1.5 <b>1.5</b>	V	
$A_{VOL}$	Large Signal Voltage Gain	$V_O = 0.15V$ to $2.2V$ $R_L = 2 k\Omega$ to $V^+/2$	88 <b>82</b>	107		dB	
		$V_O = 0.15V$ to $2.2V$ $R_L = 10 k\Omega$ to $V^+/2$	92 <b>88</b>	120			
$V_O$	Output Swing High	$R_L = 2 k\Omega$ to $V^+/2$	70 <b>77</b>	25		mV from $V^+$	
		$R_L = 10 k\Omega$ to $V^+/2$	60 <b>66</b>	20			
	Output Swing Low	$R_L = 2 k\Omega$ to $V^+/2$			30	70 <b>73</b>	mV
		$R_L = 10 k\Omega$ to $V^+/2$			15	60 <b>62</b>	
$I_O$	Output Short Circuit Current	Sourcing to $V^-$ $V_{IN} = 200$ mV (Note 9)	36 <b>30</b>	46		mA	
		Sinking to $V^+$ $V_{IN} = -200$ mV (Note 9)	7.5 <b>5.0</b>	15			
$I_S$	Supply Current			1.1	1.5 <b>1.75</b>	mA	
SR	Slew Rate	$A_V = +1$ , Rising (10% to 90%)		9.3		$V/\mu s$	
		$A_V = +1$ , Falling (90% to 10%)		10.8			

Symbol	Parameter	Conditions	Min (Note 5)	Typ (Note 4)	Max (Note 5)	Units
GBW	Gain Bandwidth Product			15		MHz
$e_n$	Input-Referred Voltage Noise	$f = 400 \text{ Hz}$		8		$\text{nV}/\sqrt{\text{Hz}}$
		$f = 1 \text{ kHz}$		7		
$i_n$	Input-Referred Current Noise	$f = 1 \text{ kHz}$		0.01		$\text{pA}/\sqrt{\text{Hz}}$
THD+N	Total Harmonic Distortion + Noise	$f = 1 \text{ kHz}, A_V = 2, R_L = 100 \text{ k}\Omega$ $V_O = 0.9 V_{PP}$		0.003		%
		$f = 1 \text{ kHz}, A_V = 2, R_L = 600\Omega$ $V_O = 0.9 V_{PP}$		0.003		

## 5V Electrical Characteristics

Unless otherwise specified, all limits are guaranteed for  $T_A = 25^\circ\text{C}$ ,  $V^+ = 5\text{V}$ ,  $V^- = 0\text{V}$ ,  $V_{CM} = (V^+ + V^-)/2$ . **Boldface** limits apply at the temperature extremes.

Symbol	Parameter	Conditions	Min (Note 5)	Typ (Note 4)	Max (Note 5)	Units	
$V_{OS}$	Input Offset Voltage			$\pm 26$	$\pm 150$ <b><math>\pm 450</math></b>	$\mu\text{V}$	
TC $V_{OS}$	Input Offset Average Drift (Note 6)			-1.5	-4	$\mu\text{V}/^\circ\text{C}$	
$I_{BIAS}$	Input Bias Current	$V_{CM} = 1\text{V}$ (Notes 7, 8)	$25^\circ\text{C}$	$\pm 3$	$\pm 20$	fA	
			-40°C to 85°C		$\pm 900$		
			-40°C to 125°C		<b><math>\pm 5</math></b>	pA	
$I_{OS}$	Input Offset Current	(Note 8)		6	40	fA	
CMRR	Common Mode Rejection Ratio	$0\text{V} \leq V_{CM} \leq 3.7\text{V}$	84 <b>82</b>	100		dB	
PSRR	Power Supply Rejection Ratio	$1.8\text{V} \leq V^+ \leq 5.5\text{V}$ $V^- = 0\text{V}, V_{CM} = 0$	84 <b>80</b>	96		dB	
CMVR	Input Common-Mode Voltage Range	CMRR $\geq 80 \text{ dB}$ CMRR $\geq 78 \text{ dB}$	-0.3 <b>-0.3</b>		4 <b>4</b>	V	
$A_{VOL}$	Large Signal Voltage Gain	$V_O = 0.3\text{V to } 4.7\text{V}$ $R_L = 2 \text{ k}\Omega \text{ to } V^+/2$	88 <b>82</b>	111		dB	
		$V_O = 0.3\text{V to } 4.7\text{V}$ $R_L = 10 \text{ k}\Omega \text{ to } V^+/2$	92 <b>88</b>	120			
$V_O$	Output Swing High	$R_L = 2 \text{ k}\Omega \text{ to } V^+/2$	70 <b>77</b>	30		mV from $V^+$	
		$R_L = 10 \text{ k}\Omega \text{ to } V^+/2$	60 <b>66</b>	20			
	Output Swing Low	$R_L = 2 \text{ k}\Omega \text{ to } V^+/2$			31	70 <b>73</b>	mV
		$R_L = 10 \text{ k}\Omega \text{ to } V^+/2$			20	60 <b>62</b>	
$I_O$	Output Short Circuit Current	Sourcing to $V^-$ $V_{IN} = 200 \text{ mV}$ (Note 9)	46 <b>38</b>	60		mA	
		Sinking to $V^+$ $V_{IN} = -200 \text{ mV}$ (Note 9)	10.5 <b>6.5</b>	22			
$I_S$	Supply Current			1.3	1.7 <b>1.95</b>	mA	
SR	Slew Rate	$A_V = +1$ , Rising (10% to 90%)		10.43		V/ $\mu\text{s}$	
		$A_V = +1$ , Falling (90% to 10%)		12.76			
GBW	Gain Bandwidth Product			17		MHz	

Symbol	Parameter	Conditions	Min (Note 5)	Typ (Note 4)	Max (Note 5)	Units
$e_n$	Input-Referred Voltage Noise	$f = 400 \text{ Hz}$		7.5		$\text{nV}/\sqrt{\text{Hz}}$
		$f = 1 \text{ kHz}$		6.5		
$i_n$	Input-Referred Current Noise	$f = 1 \text{ kHz}$		0.01		$\text{pA}/\sqrt{\text{Hz}}$
THD+N	Total Harmonic Distortion + Noise	$f = 1 \text{ kHz}, A_V = 2, R_L = 100 \text{ k}\Omega$ $V_O = 4 V_{PP}$		0.0007		%
		$f = 1 \text{ kHz}, A_V = 2, R_L = 600\Omega$ $V_O = 4 V_{PP}$		0.0007		

**Note 1:** Absolute Maximum Ratings indicate limits beyond which damage to the device may occur. Operating Ratings indicate conditions for which the device is intended to be functional, but specific performance is not guaranteed. For guaranteed specifications and the test conditions, see the Electrical Characteristics Tables.

**Note 2:** Human Body Model, applicable std. MIL-STD-883, Method 3015.7. Machine Model, applicable std. JESD22-A115-A (ESD MM std. of JEDEC) Field-Induced Charge-Device Model, applicable std. JESD22-C101-C (ESD FICDM std. of JEDEC).

**Note 3:** The maximum power dissipation is a function of  $T_{J(\text{MAX})}$ ,  $\theta_{JA}$ . The maximum allowable power dissipation at any ambient temperature is  $P_D = (T_{J(\text{MAX})} - T_A)/\theta_{JA}$ . All numbers apply for packages soldered directly onto a PC Board.

**Note 4:** Typical values represent the most likely parametric norm as determined at the time of characterization. Actual typical values may vary over time and will also depend on the application and configuration. The typical values are not tested and are not guaranteed on shipped production material.

**Note 5:** Limits are 100% production tested at 25°C. Limits over the operating temperature range are guaranteed through correlations using the Statistical Quality Control (SQC) method.

**Note 6:** Offset voltage average drift is determined by dividing the change in  $V_{OS}$  at the temperature extremes by the total temperature change.

**Note 7:** Positive current corresponds to current flowing into the device.

**Note 8:** This parameter is guaranteed by design and/or characterization and is not tested in production.

**Note 9:** The short circuit test is a momentary open loop test.

**Note 10:** The voltage on any pin should not exceed 6V relative to any other pins.

## Connection Diagram

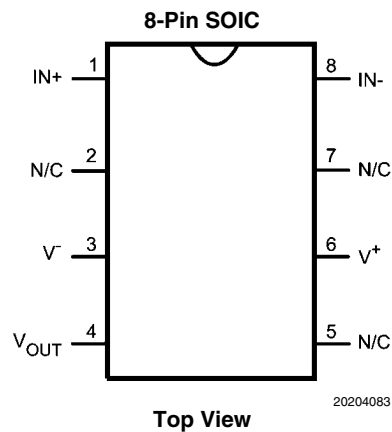

## Ordering Information

Package	Part Number	Package Marking	Transport Media	NSC Drawing
8-Pin SOIC	LMP7721MA	LMP7721MA	95 Units/Rail	M08A
	LMP7721MAX		2.5k Units Tape and Reel	

# Typical Performance Characteristics

Unless otherwise specified:  $T_A = 25^\circ\text{C}$ ,  $V_{CM} = (V^+ + V^-)/2$ .

[查询"LMP7721MA"供应商](#)

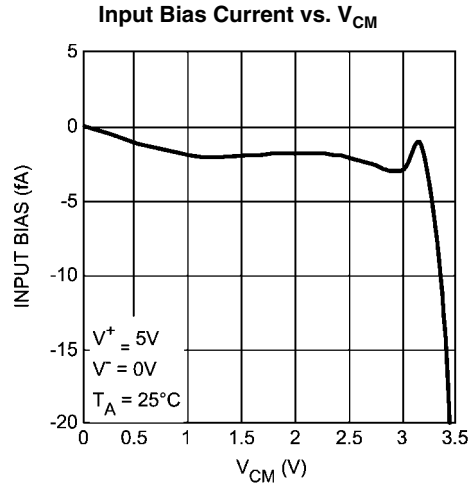

20204094

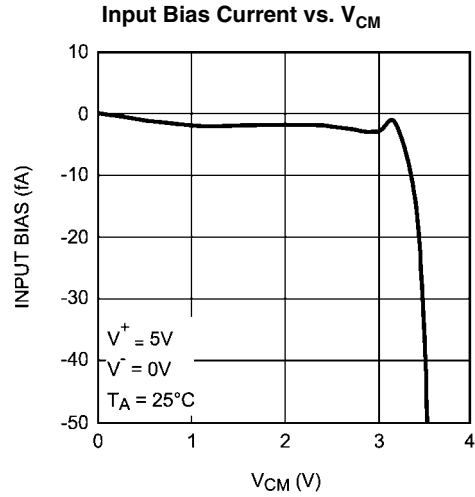

20204087

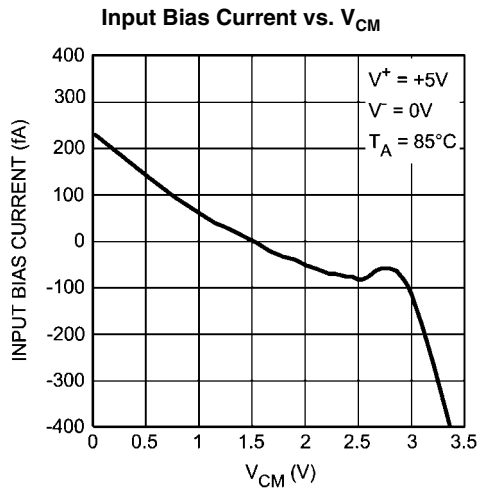

20204095

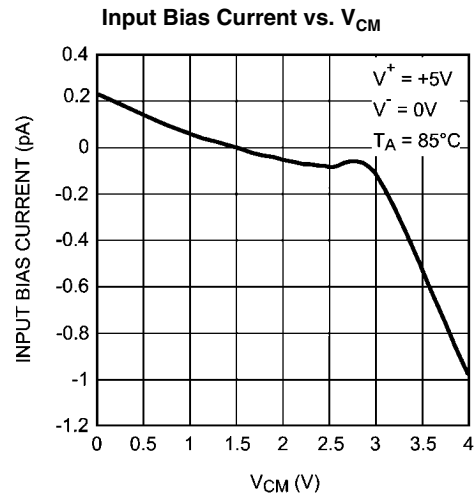

20204086

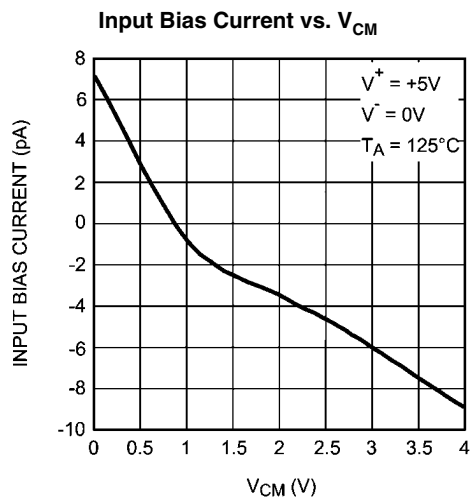

20204085

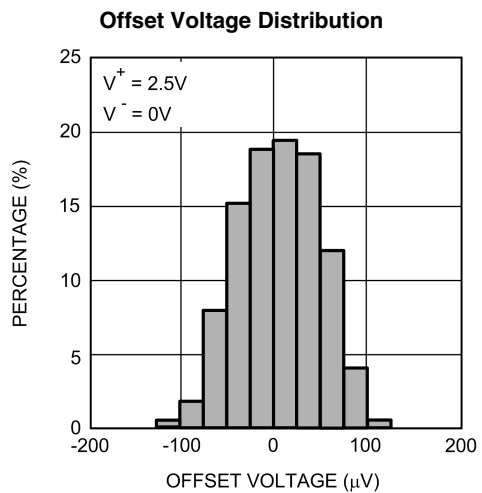

20204039

查询"LMP7721MA"供应商

Offset Voltage Distribution

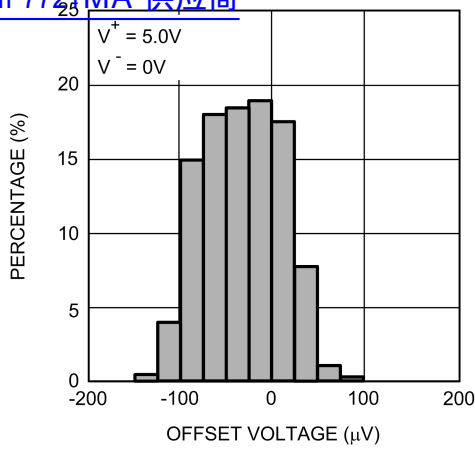

20204040

TCV<sub>OS</sub> Distribution

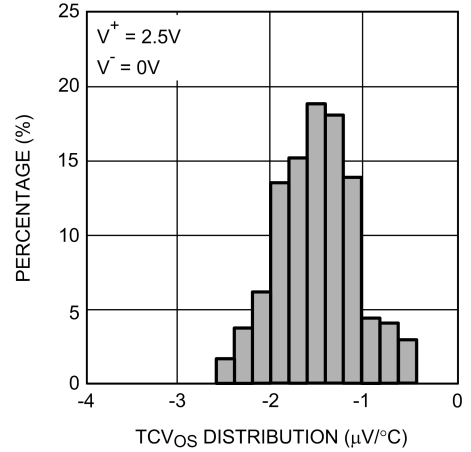

20204045

TCV<sub>OS</sub> Distribution

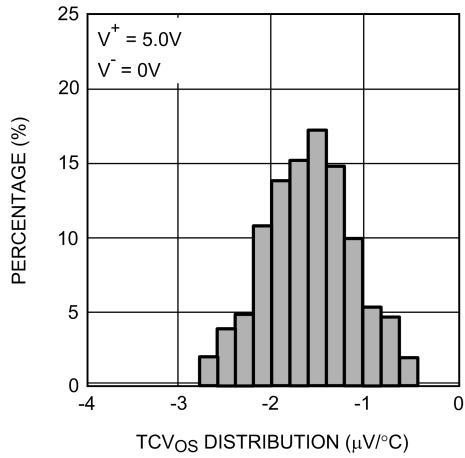

20204046

Offset Voltage vs. V<sub>CM</sub>

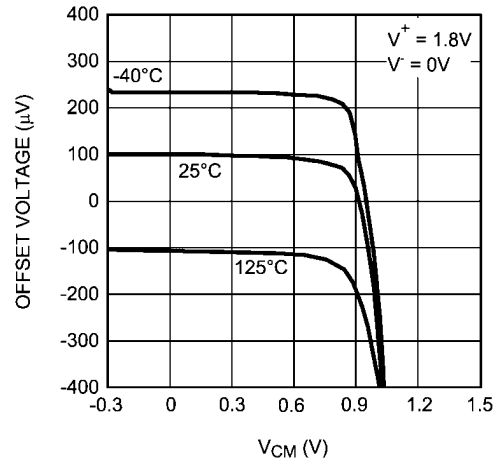

20204021

Offset Voltage vs. V<sub>CM</sub>

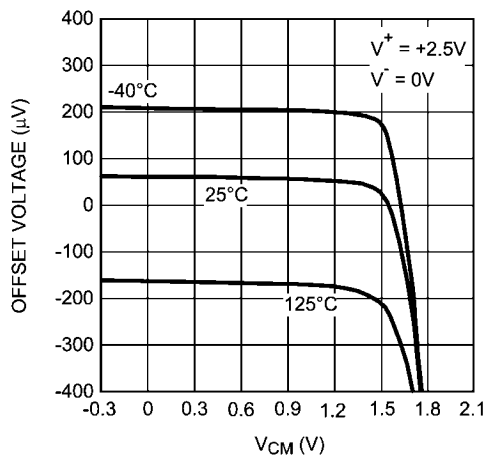

20204022

Offset Voltage vs. V<sub>CM</sub>

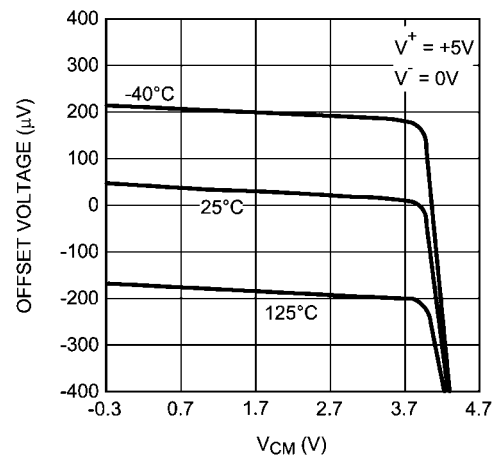

20204023

Offset Voltage vs. Supply Voltage  
 查询"LMP7721MA"供应商

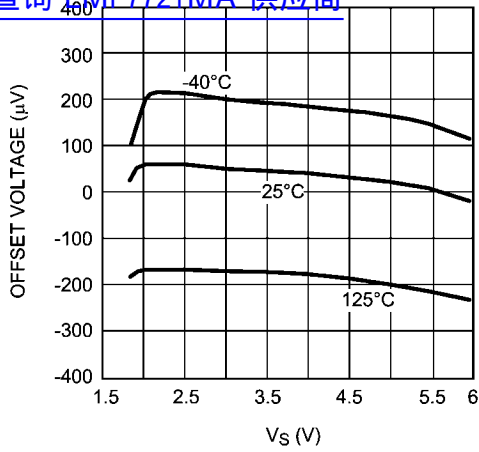

20204019

Offset Voltage vs. Temperature

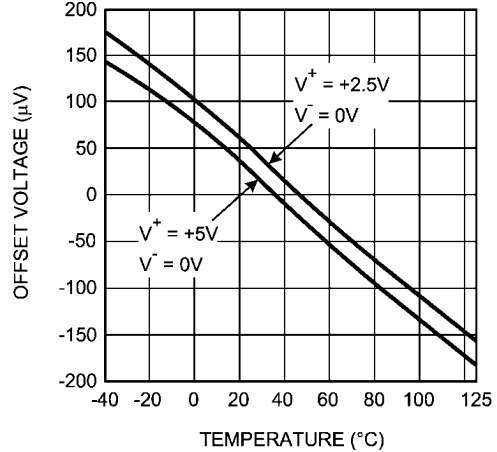

20204018

Supply Current vs. Supply Voltage

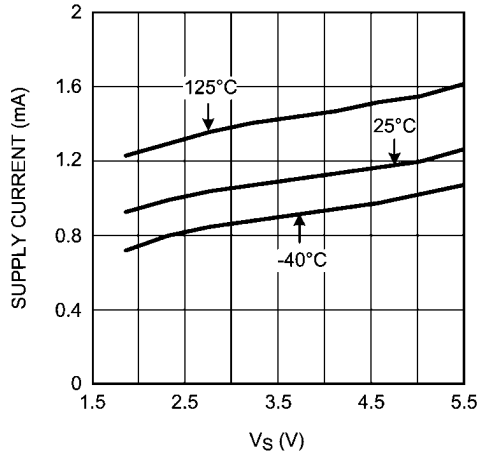

20204038

Open Loop Frequency Response Gain and Phase

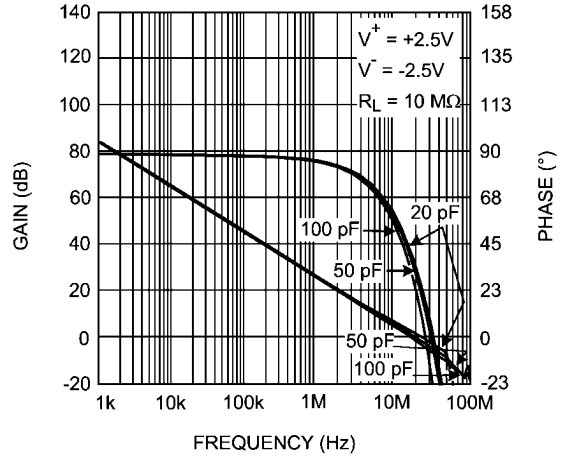

20204017

Open Loop Frequency Response Gain and Phase

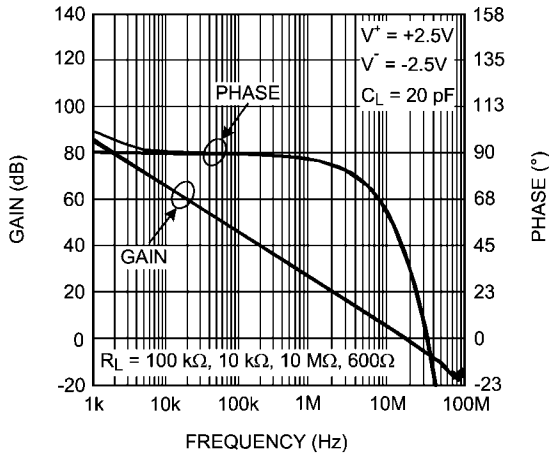

20204014

Phase Margin vs. Capacitive Load

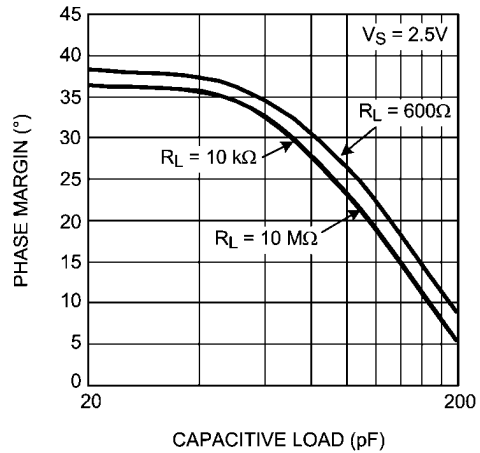

20204015

Phase Margin vs. Capacitive Load  
[查询"LMP7721MA"供应商](#)

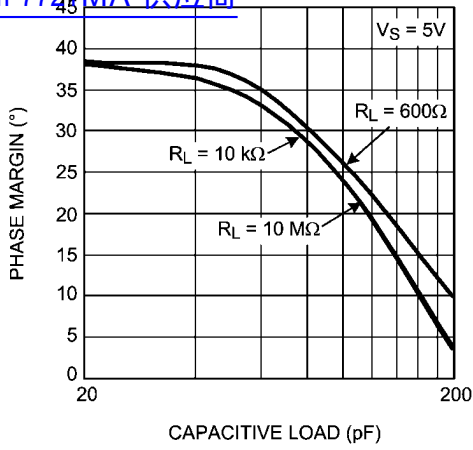

20204016

CMRR vs. Frequency

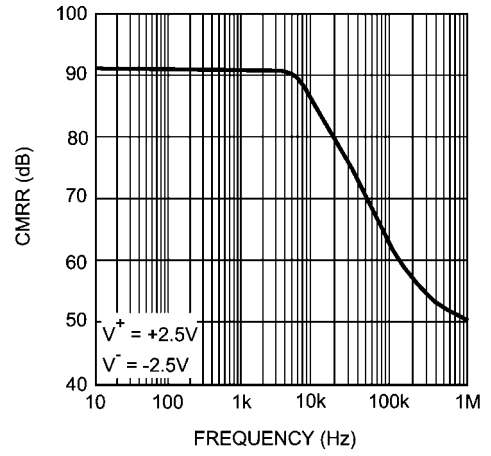

20204012

PSRR vs. Frequency

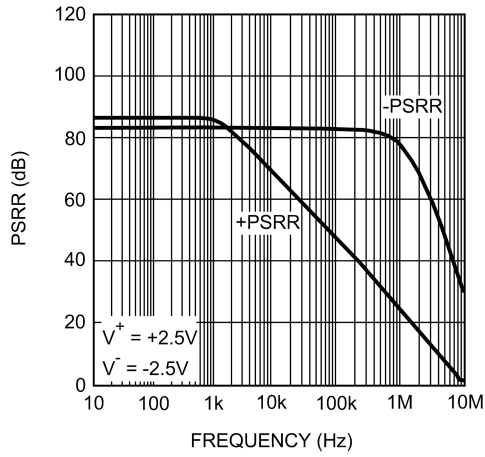

20204041

Input Referred Voltage Noise vs. Frequency

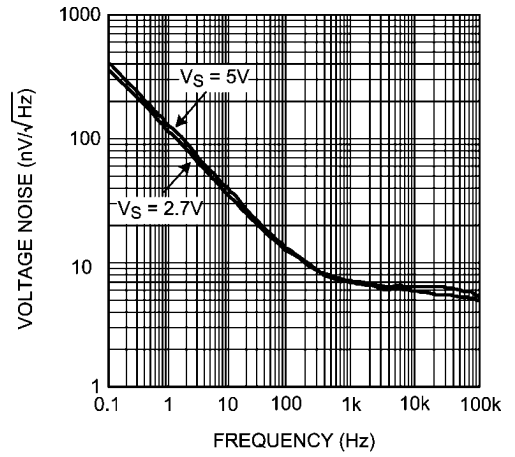

20204013

Time Domain Voltage Noise

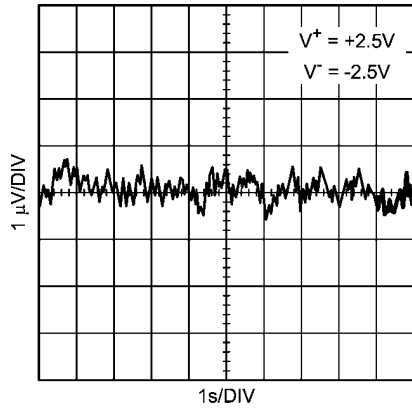

20204010

Small Signal Step Response

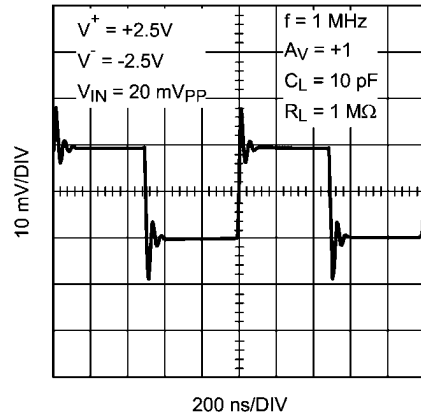

20204003



Small Signal Step Response

查询"LMP7721MA"供应商

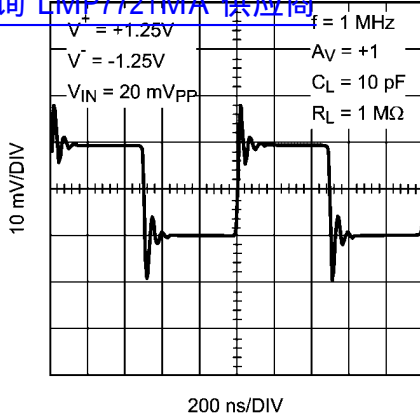

20204004

Large Signal Step Response

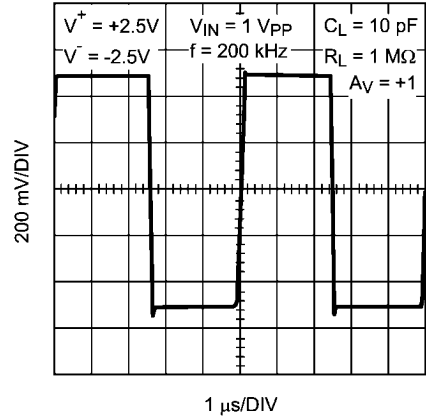

20204006

Large Signal Step Response

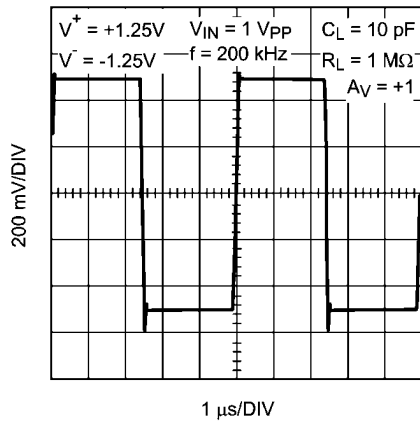

20204005

THD+N vs. Output Voltage

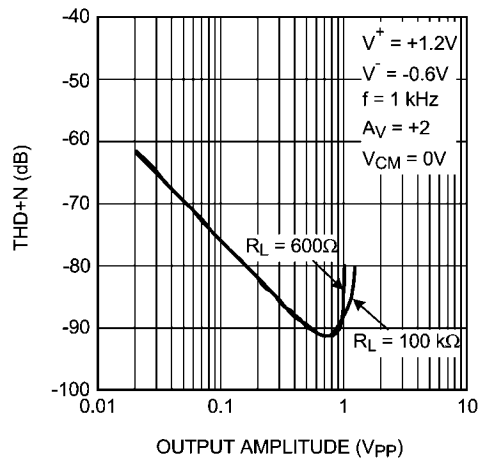

20204011

THD+N vs. Output Voltage

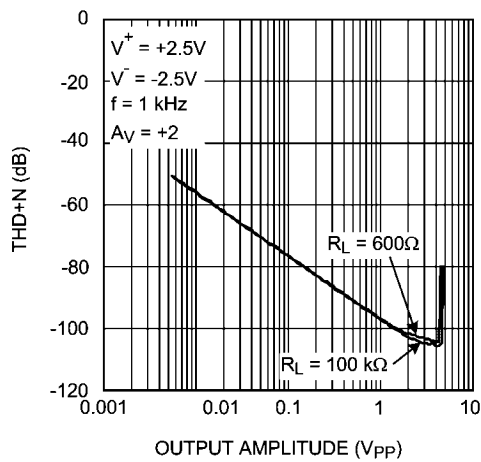

20204007

THD+N vs. Frequency

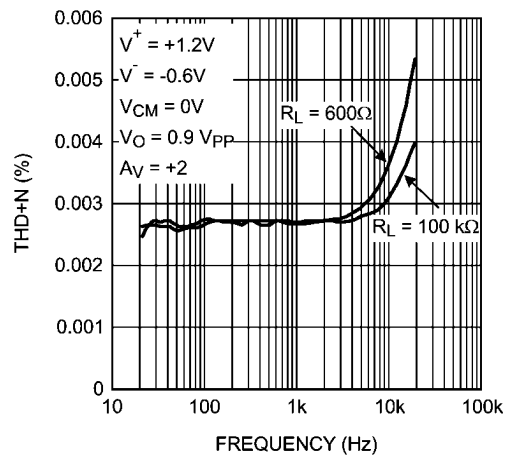

20204008

查询"LMP7721MA"供应商

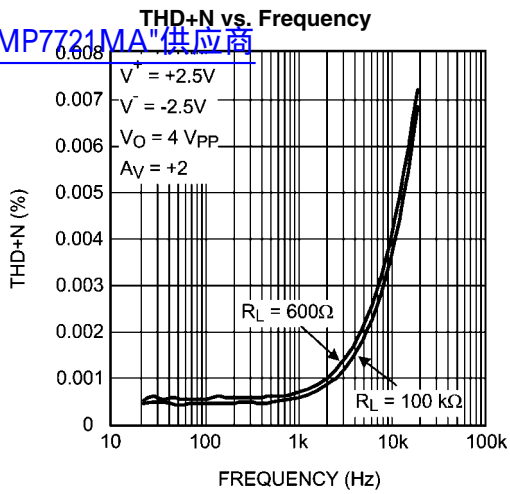

20204009

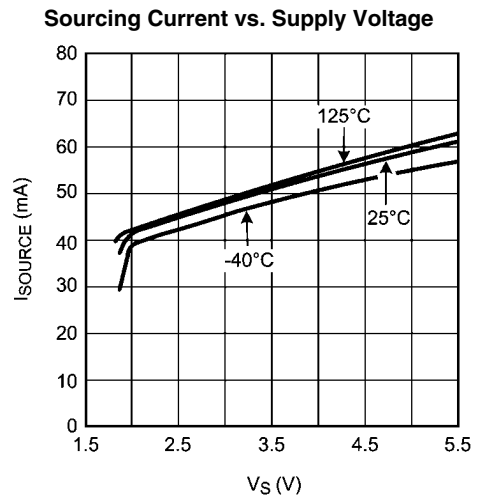

20204037

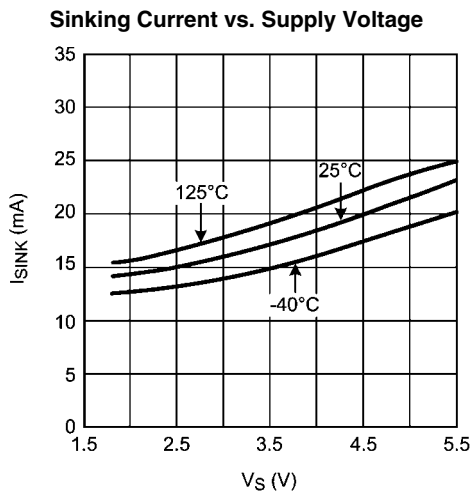

20204033

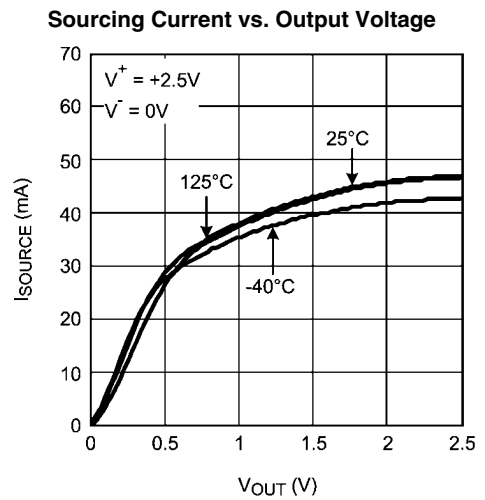

20204034

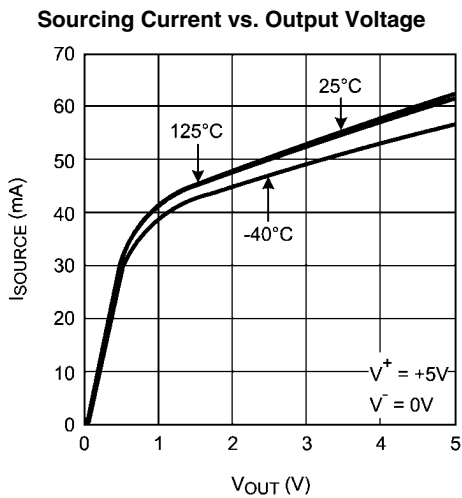

20204035

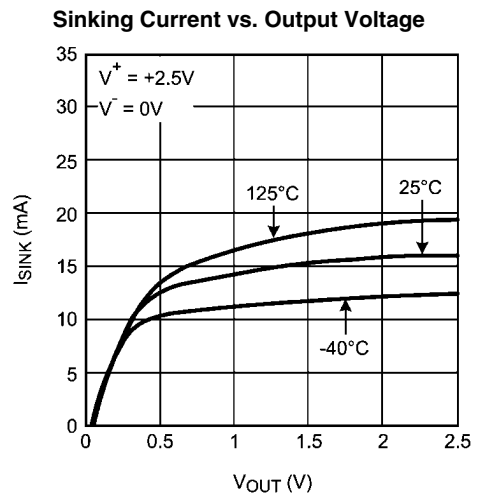

20204031

Sinking Current vs. Output Voltage  
[查询"LMP7721MA"供应商](#)

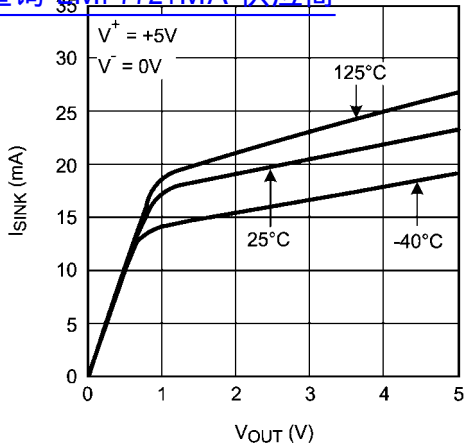

20204032

Output Swing High vs. Supply Voltage

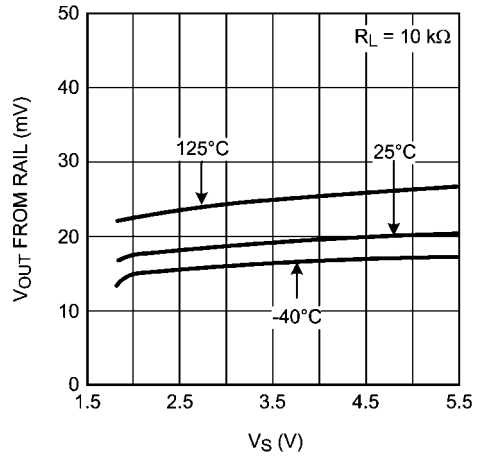

20204025

Output Swing Low vs. Supply Voltage

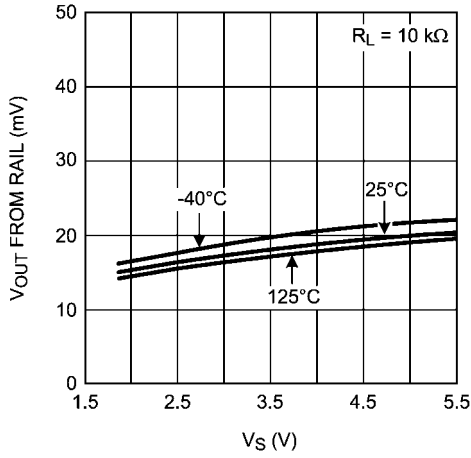

20204029

Output Swing High vs. Supply Voltage

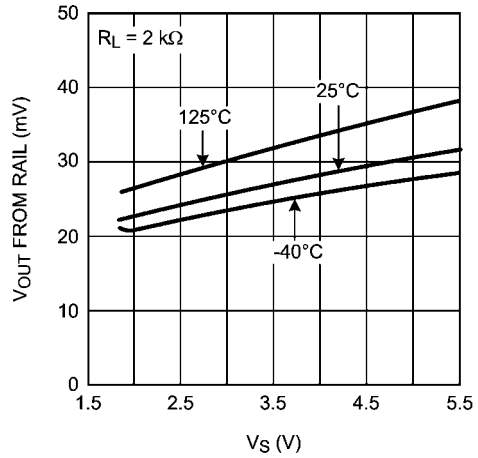

20204024

Output Swing Low vs. Supply Voltage

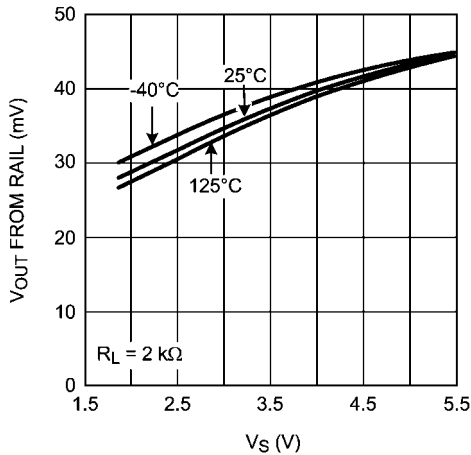

20204028

Output Swing High vs. Supply Voltage

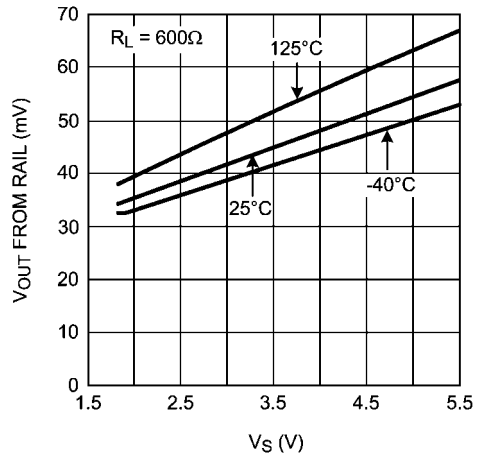

20204026

### Output Swing Low vs. Supply Voltage

查询"LMP7721MA"供应商

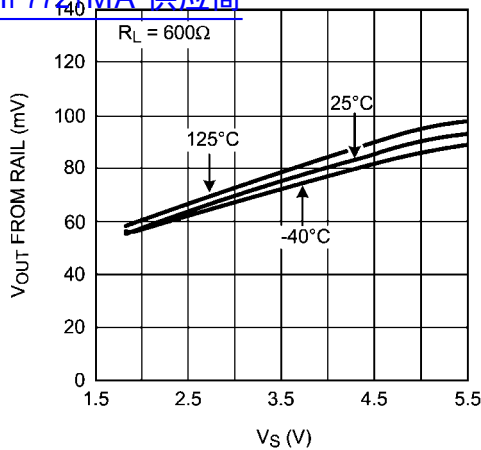

20204030

## Application Information

### ADVANTAGES OF THE LMP7721

#### Ultra Low Input Bias Current

The LMP7721 has the industry's lowest guaranteed input bias current. The ultra low input bias current is typically 3 fA, with a guaranteed limit of  $\pm 20$  fA at 25°C,  $\pm 900$  fA at 85°C and  $\pm 5$  pA at 125°C when  $V_{CM} = 1$  V with a 5V or a 2.5V power supply.

#### Wide Bandwidth at Low Supply Current

The LMP7721 is a high performance amplifier that provides a 17 MHz unity gain bandwidth while drawing only 1.3 mA of current. This makes the LMP7721 ideal for wideband amplification in portable applications.

#### Low Input Referred Noise

The LMP7721 has a low input referred voltage noise density (6.5 nV $\sqrt{\text{Hz}}$  at 1 kHz with 5V supply). Its MOS input stage ensures a very low input referred current noise density (0.01 pA $\sqrt{\text{Hz}}$ ).

The low input referred noise and the ultra low input bias current make the LMP7721 stand out in maintaining signal fidelity. This quality makes the LMP7721 a suitable candidate for sensor based applications.

#### Low Supply Voltage

The LMP7721 has performance guaranteed at 2.5V and 5V power supplies. The LMP7721 is guaranteed to be functional at all supply voltages between 2.0V to 5.5V, for ambient temperatures ranging from -40°C to 125°C. This means that the LMP7721 has a long operational span over the battery's lifetime. The LMP7721 is also guaranteed to be functional at 1.8V supply voltage, for ambient temperatures ranging from 0°C to 125°C. This makes the LMP7721 ideal for use in low voltage commercial applications.

#### RRO and Ground Sensing

Rail-to-rail output swing provides the maximum possible output dynamic range. This is particularly important when operating at low supply voltages. An innovative positive feedback scheme is created to boost the LMP7721's output current drive capability. This allows the LMP7721 to source 30 mA to 40 mA of current at 1.8V power supply.

The LMP7721's input common mode range includes the negative supply rail which makes direct sensing at ground possible in single supply operation.

#### Unique Pinout

The LMP7721 has been designed with the IN+ and IN-, V+ and V- pins on opposite sides of the package. There are isolation pins between IN+ and V-, IN- and V+. This unique pinout makes it easy to guard the LMP7721's input. This pinout design reduces the input bias current's dependence on common mode or supply bias.

The SOIC package features low leakage and it has large pin spacing. This lowers the probability of dust particles settling down between two pins thus reducing the resistance between the pins which can be a problem.

#### Input Protection

The LMP7721 input stage is protected from seeing excessive differential input voltage by a pair of back-to-back diodes attached between the inputs. This limits the differential voltage and hence prevents phase inversion as well as any performance drift. These diodes can conduct current when the input signal has a really fast edge, and, if necessary, should be isolated (using a resistor or a current follower) in such cases.

#### SYSTEM DESIGN TECHNIQUES WITH THE LMP7721

In order to take full advantage of the LMP7721's ultra low input bias current, a triaxial cable/connector is recommended when designing application systems.

A triaxial cable/connector is similar to a coaxial cable/connector and is often referred to as "triax". Figure 1 shows the structure of the triax.

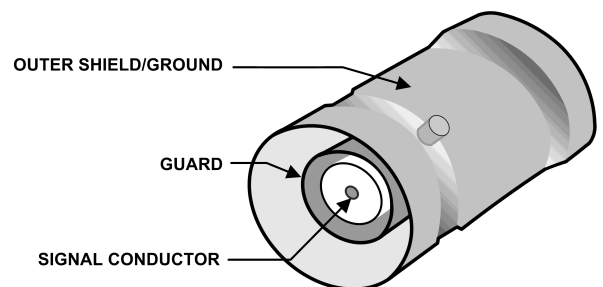

20204088

FIGURE 1. The Structure of a Triax

The signal conductor and the guard of the triax should be kept at the same potential, therefore, the leakage current between them is practically zero. Since triax has an extra layer of insulation and a second conducting sheath, it offers greater rejection of interference than coaxial cable/connector.

### TRANSIMPEDANCE AMPLIFIER EXAMPLE (INVERTING CONFIGURATION)

A transimpedance amplifier converts a small amount of current into voltage. The transfer function of a transimpedance amplifier is  $V_{out} = -I_{in} * R_F$ . Figure 2 shows a typical transimpedance amplifier.

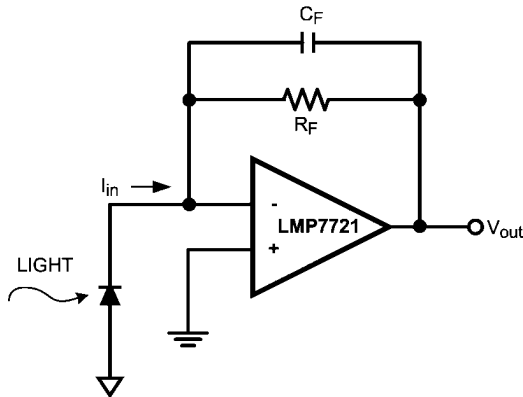

20204089

FIGURE 2. Photodiode Transimpedance Amplifier

The current is generated by a photodiode. The amount of the current is so small that it requires a large gain from the transimpedance amplifier in order to transform the miniscule current into easily detectable voltages. The larger the gain, the larger the value of  $R_F$  needed. When  $R_F$  is larger, the error caused by  $I_{bias} * R_F$  increases. For example, if  $R_F$  is 1000 M $\Omega$ , and an op amp with 3 nA of  $I_{bias}$  is used, the  $I_{bias} * R_F$  error at the output will be 3V! This error can be dramatically reduced to 3  $\mu$ V by using the LMP7721.

Photodiodes are high impedance sensors which require careful design of the associated signal conditioning circuitry in order to meet the system challenges. CMOS input op amps are often used in transimpedance applications as they have extremely high input impedance. A triaxial cable is recommended for its very low noise pick-up.

A MOS input stage with ultra low input bias current, negligible input current noise, and low input voltage noise allows the LMP7721 to provide high fidelity amplification. In addition, the LMP7721 has a 17 MHz gain bandwidth product, which enables high gain at wide bandwidth. A rail-to-rail output swing at 5.5V power supply allows detection and amplification of a wide range of input currents. These properties make the LMP7721 ideal for transimpedance amplification.

Figure 3 is an example of the LMP7721 used as a transimpedance amplifier.

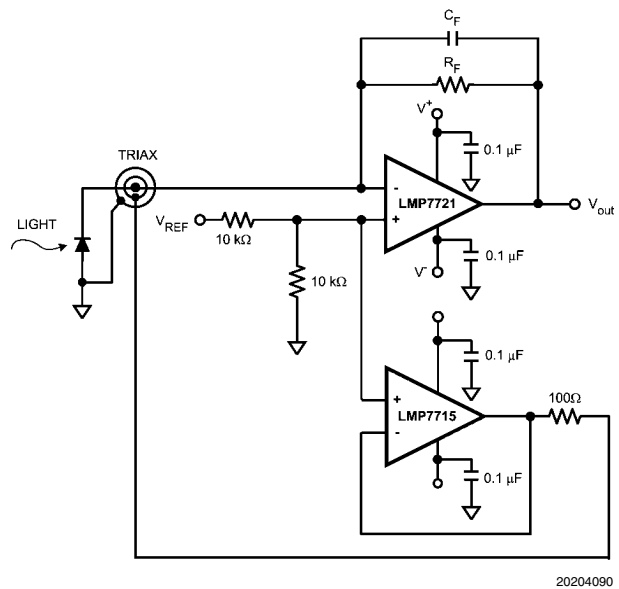

20204090

FIGURE 3. LMP7721 as Transimpedance Amplifier

The current generated by the photodiode is fed to the signal conductor of the triax and then sent to the inverting input of the LMP7721. The LMP7721's non-inverting input is biased at  $V_{REF}/2$  for level shifting purposes. In this application, the non-inverting input is a low impedance node and hence is used to drive the LMP7715 which acts as a guard driver. The output of the guard driver is connected to the guard of the triax via a 100 $\Omega$  isolation resistor. Ideally, the inverting and the non-inverting inputs of the amplifier are kept at the same potential through the operation of the amplifier. By connecting the signal conductor to the inverting input and letting the non-inverting input drive the guard, the signal conductor and the guard are kept at the same potential which prevents leakage from the signal source.

### pH ELECTRODE AMPLIFIER EXAMPLE (NON-INVERTING CONFIGURATION)

The output of a pH electrode ranges from 415 mV to -415 mV as the pH changes from 0 to 14 at 25°C. The output impedance of a pH electrode is extremely high, ranging from 10 M $\Omega$  to 1000 M $\Omega$ . The ultra low input bias current of the LMP7721 allows the voltage error produced by the input bias current and electrode resistance to be minimal. For example, the output impedance of the pH electrode used is 10 M $\Omega$ , if an op amp with 3 nA of  $I_{bias}$  is used, the error caused due to this amplifier's input bias current and the source resistance of the pH electrode is 30 mV! This error can be greatly reduced to 30 nV by using the LMP7721.

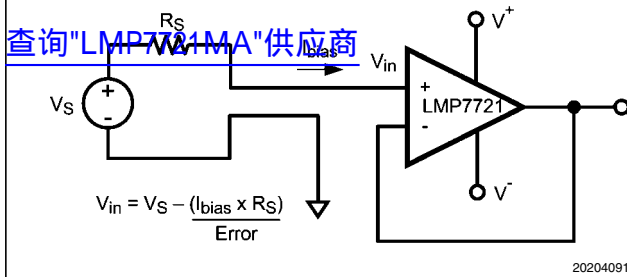

20204091

**FIGURE 4. Error Caused by Amplifier's Input Bias Current and Sensor Source Impedance**

Figure 5 is an example of the LMP7721 used as a pH sensor amplifier.

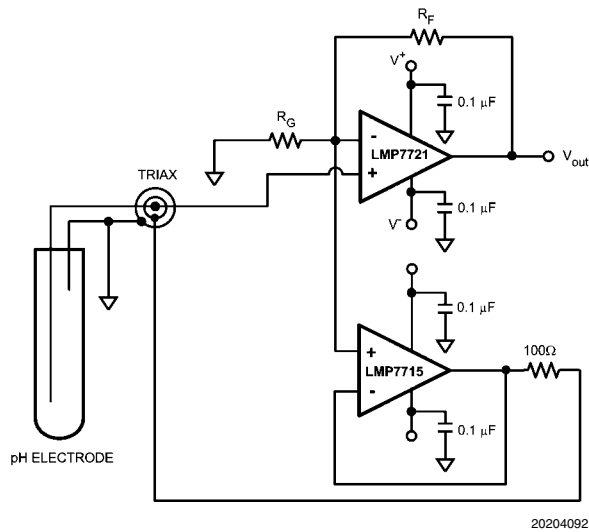

20204092

**FIGURE 5. LMP7721 as pH Electrode Amplifier**

The output voltage from the pH electrode is fed to the signal conductor of the triax and then sent to the non-inverting input of the LMP7721. In this application, the inverting input is a low impedance node and hence is used to drive the LMP7715

which acts as a guard driver. The output of the guard driver is connected to the guard of the triax via a 100Ω isolation resistor. Ideally, the inverting and the non-inverting inputs of the amplifier are kept at the same potential through the operation of the amplifier. By connecting the signal conductor to the non-inverting input and letting the inverting input drive the guard, the signal conductor and the guard are kept at the same potential which prevents leakage from the signal source.

#### LAYOUT AND ASSEMBLY CONSIDERATIONS

In order to capitalize on the LMP7721's ultra low input bias current, careful circuit layout and assembly are required. Guarding techniques are highly recommended to reduce parasitic leakage current by isolating the LMP7721's input from large voltage gradients across the PC board. A guard is a low impedance conductor that surrounds an input line and its potential is raised to the input line's voltage. The input pins should be fully guarded as shown in Figure 6. The guard traces should completely encircle the input connections. In addition, they should be located on both sides of the PCB and be connected together.

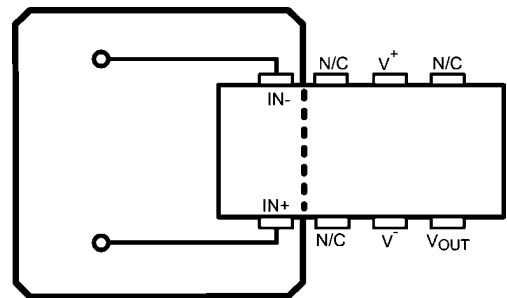

20204093

**FIGURE 6. Circuit Board Guard Layout**

Solder mask should not cover the input and the guard area including guard traces on either side of the PCB.

Sockets are not recommended as they can be a significant leakage source. After assembly, a thorough cleaning using commercial solvent is necessary.

**Physical Dimensions** inches (millimeters) unless otherwise noted  
[查询"LMP7721MA"供应商](#)

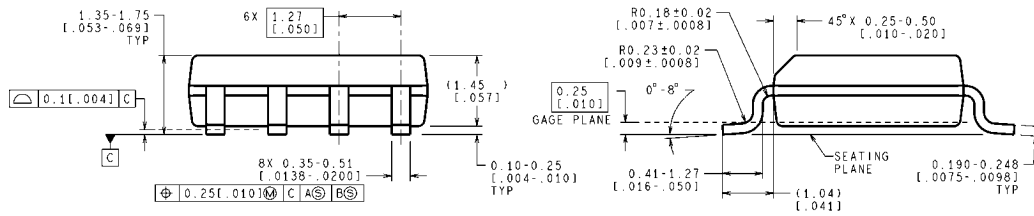
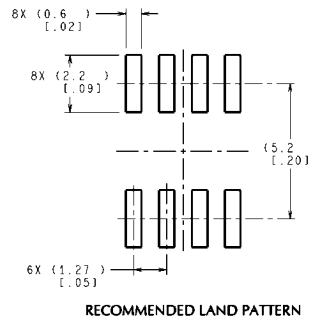
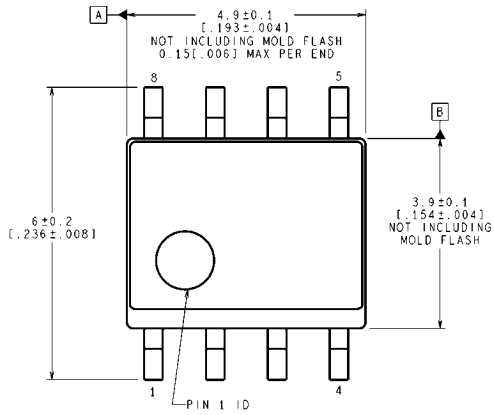

CONTROLLING DIMENSION IS MILLIMETER  
 VALUES IN [ ] ARE INCHES  
 DIMENSIONS IN ( ) FOR REFERENCE ONLY

**8-Pin SOIC**  
**NS Package Number M08A**

M08A (Rev L)

[查询"LMP7721MA"供应商](#)

## Notes

For more National Semiconductor product information and proven design tools, visit the following Web sites at:

Products		Design Support	
Amplifiers	<a href="http://www.national.com/amplifiers">www.national.com/amplifiers</a>	WEBENCH	<a href="http://www.national.com/webench">www.national.com/webench</a>
Audio	<a href="http://www.national.com/audio">www.national.com/audio</a>	Analog University	<a href="http://www.national.com/AU">www.national.com/AU</a>
Clock Conditioners	<a href="http://www.national.com/timing">www.national.com/timing</a>	App Notes	<a href="http://www.national.com/appnotes">www.national.com/appnotes</a>
Data Converters	<a href="http://www.national.com/adc">www.national.com/adc</a>	Distributors	<a href="http://www.national.com/contacts">www.national.com/contacts</a>
Displays	<a href="http://www.national.com/displays">www.national.com/displays</a>	Green Compliance	<a href="http://www.national.com/quality/green">www.national.com/quality/green</a>
Ethernet	<a href="http://www.national.com/ethernet">www.national.com/ethernet</a>	Packaging	<a href="http://www.national.com/packaging">www.national.com/packaging</a>
Interface	<a href="http://www.national.com/interface">www.national.com/interface</a>	Quality and Reliability	<a href="http://www.national.com/quality">www.national.com/quality</a>
LVDS	<a href="http://www.national.com/lvds">www.national.com/lvds</a>	Reference Designs	<a href="http://www.national.com/refdesigns">www.national.com/refdesigns</a>
Power Management	<a href="http://www.national.com/power">www.national.com/power</a>	Feedback	<a href="http://www.national.com/feedback">www.national.com/feedback</a>
Switching Regulators	<a href="http://www.national.com/switchers">www.national.com/switchers</a>		
LDOs	<a href="http://www.national.com/lido">www.national.com/lido</a>		
LED Lighting	<a href="http://www.national.com/led">www.national.com/led</a>		
PowerWise	<a href="http://www.national.com/powerwise">www.national.com/powerwise</a>		
Serial Digital Interface (SDI)	<a href="http://www.national.com/sdi">www.national.com/sdi</a>		
Temperature Sensors	<a href="http://www.national.com/tempsensors">www.national.com/tempsensors</a>		
Wireless (PLL/VCO)	<a href="http://www.national.com/wireless">www.national.com/wireless</a>		

THE CONTENTS OF THIS DOCUMENT ARE PROVIDED IN CONNECTION WITH NATIONAL SEMICONDUCTOR CORPORATION ("NATIONAL") PRODUCTS. NATIONAL MAKES NO REPRESENTATIONS OR WARRANTIES WITH RESPECT TO THE ACCURACY OR COMPLETENESS OF THE CONTENTS OF THIS PUBLICATION AND RESERVES THE RIGHT TO MAKE CHANGES TO SPECIFICATIONS AND PRODUCT DESCRIPTIONS AT ANY TIME WITHOUT NOTICE. NO LICENSE, WHETHER EXPRESS, IMPLIED, ARISING BY ESTOPPEL OR OTHERWISE, TO ANY INTELLECTUAL PROPERTY RIGHTS IS GRANTED BY THIS DOCUMENT.

TESTING AND OTHER QUALITY CONTROLS ARE USED TO THE EXTENT NATIONAL DEEMS NECESSARY TO SUPPORT NATIONAL'S PRODUCT WARRANTY. EXCEPT WHERE MANDATED BY GOVERNMENT REQUIREMENTS, TESTING OF ALL PARAMETERS OF EACH PRODUCT IS NOT NECESSARILY PERFORMED. NATIONAL ASSUMES NO LIABILITY FOR APPLICATIONS ASSISTANCE OR BUYER PRODUCT DESIGN. BUYERS ARE RESPONSIBLE FOR THEIR PRODUCTS AND APPLICATIONS USING NATIONAL COMPONENTS. PRIOR TO USING OR DISTRIBUTING ANY PRODUCTS THAT INCLUDE NATIONAL COMPONENTS, BUYERS SHOULD PROVIDE ADEQUATE DESIGN, TESTING AND OPERATING SAFEGUARDS.

EXCEPT AS PROVIDED IN NATIONAL'S TERMS AND CONDITIONS OF SALE FOR SUCH PRODUCTS, NATIONAL ASSUMES NO LIABILITY WHATSOEVER, AND NATIONAL DISCLAIMS ANY EXPRESS OR IMPLIED WARRANTY RELATING TO THE SALE AND/OR USE OF NATIONAL PRODUCTS INCLUDING LIABILITY OR WARRANTIES RELATING TO FITNESS FOR A PARTICULAR PURPOSE, MERCHANTABILITY, OR INFRINGEMENT OF ANY PATENT, COPYRIGHT OR OTHER INTELLECTUAL PROPERTY RIGHT.

### LIFE SUPPORT POLICY

**NATIONAL'S PRODUCTS ARE NOT AUTHORIZED FOR USE AS CRITICAL COMPONENTS IN LIFE SUPPORT DEVICES OR SYSTEMS WITHOUT THE EXPRESS PRIOR WRITTEN APPROVAL OF THE CHIEF EXECUTIVE OFFICER AND GENERAL COUNSEL OF NATIONAL SEMICONDUCTOR CORPORATION.** As used herein:

Life support devices or systems are devices which (a) are intended for surgical implant into the body, or (b) support or sustain life and whose failure to perform when properly used in accordance with instructions for use provided in the labeling can be reasonably expected to result in a significant injury to the user. A critical component is any component in a life support device or system whose failure to perform can be reasonably expected to cause the failure of the life support device or system or to affect its safety or effectiveness.

National Semiconductor and the National Semiconductor logo are registered trademarks of National Semiconductor Corporation. All other brand or product names may be trademarks or registered trademarks of their respective holders.

Copyright© 2008 National Semiconductor Corporation

For the most current product information visit us at [www.national.com](http://www.national.com)



**National Semiconductor  
Americas Technical  
Support Center**  
Email:  
[new.feedback@nsc.com](mailto:new.feedback@nsc.com)  
Tel: 1-800-272-9959

**National Semiconductor Europe  
Technical Support Center**  
Email: [europe.support@nsc.com](mailto:europe.support@nsc.com)  
German Tel: +49 (0) 180 5010 771  
English Tel: +44 (0) 870 850 4288

**National Semiconductor Asia  
Pacific Technical Support Center**  
Email: [ap.support@nsc.com](mailto:ap.support@nsc.com)

**National Semiconductor Japan  
Technical Support Center**  
Email: [jpn.feedback@nsc.com](mailto:jpn.feedback@nsc.com)