



The Future of Analog IC Technology™

EV0030 (MP7720DS)

20W Stereo Class D
Single Ended Audio Amplifier

EVALUATION BOARD

GENERAL DESCRIPTION

The EV0030 is the evaluation board for the MP7720, a mono 20W Class D Audio Amplifier. It is one of MPS' second generation of fully integrated audio amplifiers which dramatically reduces solution size by integrating the following:

180mΩ power MOSFETs

Startup / Shutdown pop elimination

Short circuit protection circuits

Mute / Standby

The MP7720 utilizes a single ended output structure capable of delivering 20W into 4Ω speakers. MPS Class D Audio Amplifiers exhibit the high fidelity of a Class A/B amplifier at efficiencies greater than 90%. The circuit is based on the MPS' AAM™ proprietary variable frequency topology that delivers excellent PSRR, fast response time and operates on a single power supply.

ELECTRICAL SPECIFICATIONS

Parameter	Symbol	Value	Units
Supply Voltage	V_{DD}	24	V

FEATURES

- 20W Output at $V_{DD} = 24V$ into a 4Ω load
- THD+N = 0.04% at 1W, 8Ω
- 93% Efficiency at 20W
- Low Noise (190μV Typical)
- Switching Frequency Up to 1MHz
- 9.5V to 24V Operation from a Single Supply
- Integrated Startup and Shutdown Pop Elimination Circuit
- Thermal Protection
- Integrated 180mΩ Switches
- Mute/Standby Modes (Sleep)
- Available in Tiny 8-Pin SOIC and PDIP Packages

APPLICATIONS

- Surround Sound DVD Systems
- Televisions
- Flat Panel Monitors
- Multimedia Computers
- Home Stereo Systems

"MPS" and "The Future of Analog IC Technology", are Registered Trademarks of Monolithic Power Systems, Inc.

AAM (Analog Adaptive Modulation) is a Trademark of Monolithic Power Systems, Inc.

EV0030 EVALUATION BOARD

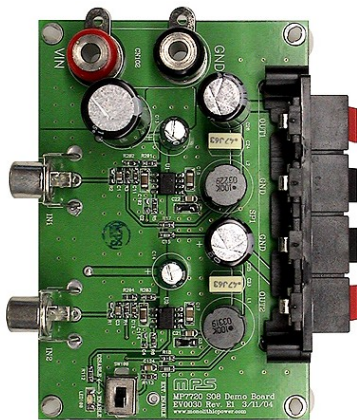

Dimensions (2.4"X x 3.5"Y x 1.2"Z)

Board Number	MPS IC Number
EV0030	MP7720DS

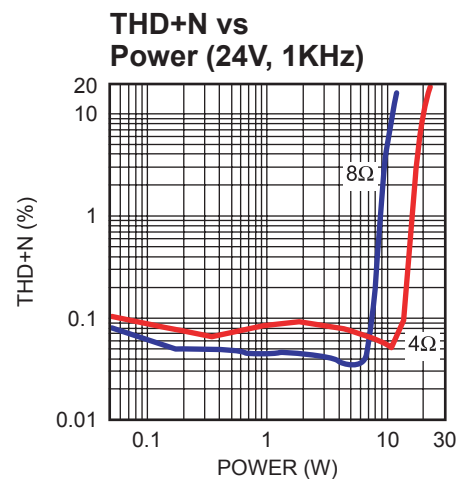

EVALUATION BOARD SCHEMATIC

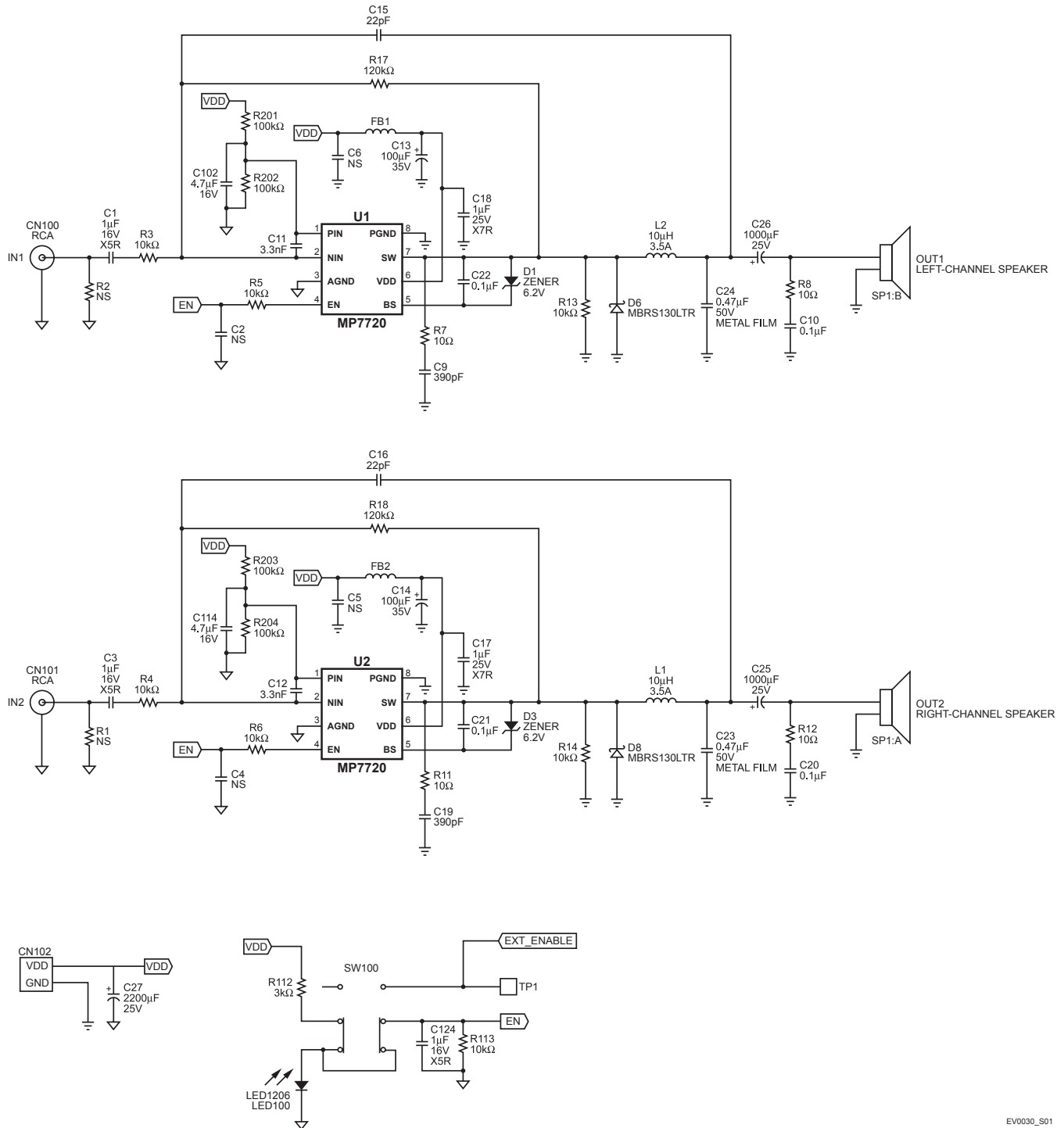

EV0030_S01

EV0030 BILL OF MATERIALS

Qty	Ref	Value	Description	Package	Manufacturer	Manufacturer P/N
3	C1, C3, C124	1 μ F	Ceramic Capacitor, X5R, 16V	SM0805	Panasonic	ECJ-2FB1C105K
4	C2, C4, C5, C6	NS	Not Stuffed			
2	C9, C19	390pF	Ceramic Capacitor, X7R, 50V	SM0805	Panasonic	ECU-V1H391KBN
2	C11, C12	3.3nF	Ceramic Capacitor, X7R, 50V	SM0805	Panasonic	ECJ-2VB1H472K
2	C13, C14	100 μ F	Electrolytic Capacitor, 35V	Radial	Panasonic	EEU-FC1V101
2	C15, C16	22pF	Ceramic Capacitor, NPO, 50V	SM0805	Panasonic	ECJ-2VC1H220J
2	C17, C18	1 μ F	Ceramic Capacitor, X7R, 25V	SM1206	Panasonic	ECJ-3YB1E105K
2	C21, C22	0.1 μ F	Ceramic Capacitor, X7R, 50V	SM0805	Panasonic	ECJ-2YB1H104K
2	C23, C24	0.47 μ F	Metallized Film Capacitor, 50V	Radial	Panasonic	ECQ-V1H474JL
2	C25, C26	1000 μ F	Electrolytic Capacitor, 25V	Radial	Panasonic	ECA-1EHG102
1	C27	2200 μ F	Electrolytic Capacitor, 25V	Radial	Panasonic	EEU-FC1E222
2	C102, C114	4.7 μ F	Ceramic Capacitor, X5R, 16V	SM1206	Panasonic	ECJ-3YB1C475M
2	D1, D3		Zener Diode, 6.2V	MINIMELF	Diodes Inc	ZMM5234B-7
2	D6, D8		Schottky Diode, 30V, 1A	SMB	IRF	MBRS130LTR
2	FB1, FB2		Ferrite Bead	SM1210	FAIR-RITE	2512067007Y3
2	L1, L2	10 μ H	Inductor, 3.5A	Radial/10RYTL	Toko	A7024LYF-100K
2	R1, R2	NS	Not Stuffed			
7	R3, R4, R5, R6, R13, R14, R113	10k Ω	Ceramic Resistor, 1%	SM0805	Panasonic	ERJ-6ENF1002V
2	R7, R11	10 Ω	Ceramic Resistor, 5%	SM0805	Panasonic	ERJ-6GEYJ100V
2	R8, R12	10 Ω	Ceramic Resistor, 5%	SM1206	Panasonic	ERJ-8GEYJ100V
2	R17, R18	120k Ω	Ceramic Resistor, 5%	SM0805	Panasonic	ERJ-6GEYJ124V
1	R112	3k Ω	Ceramic Resistor, 5%	SM0805	Panasonic	ERJ-6GEYJ302V
4	R201, R202, R203, R204	100k Ω	Ceramic Resistor, 1%	SM0805	Panasonic	ERJ-6ENF1003V
2	U1, U2		Amplifier	SOIC8	MPS	MP7720

PRINTED CIRCUIT BOARD LAYOUT

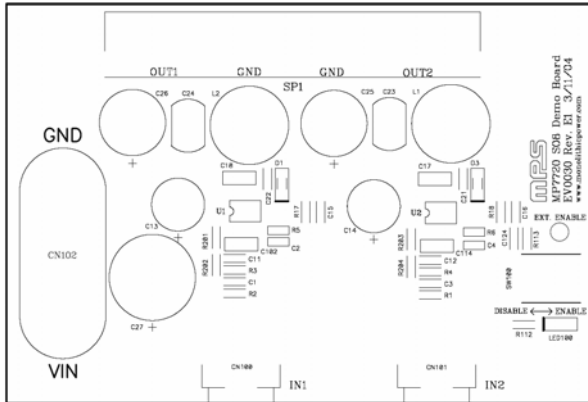

Figure 1—Top Silk Layer

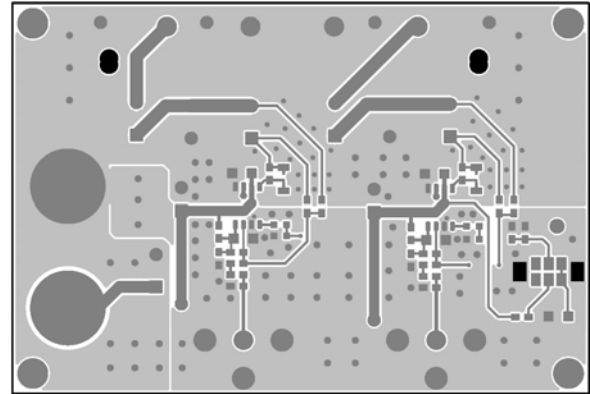

Figure 2—Top Layer

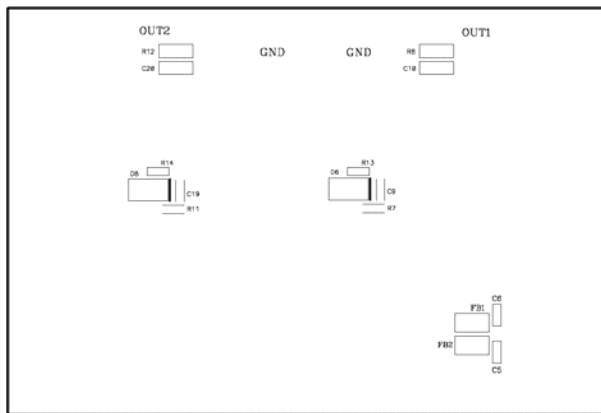

Figure 3—Bottom Silk Layer

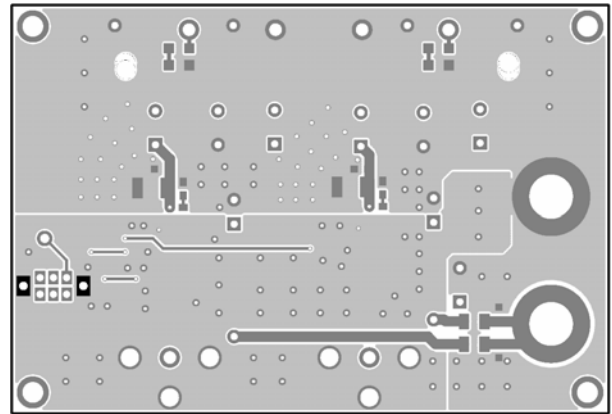

Figure 4—Bottom Layer

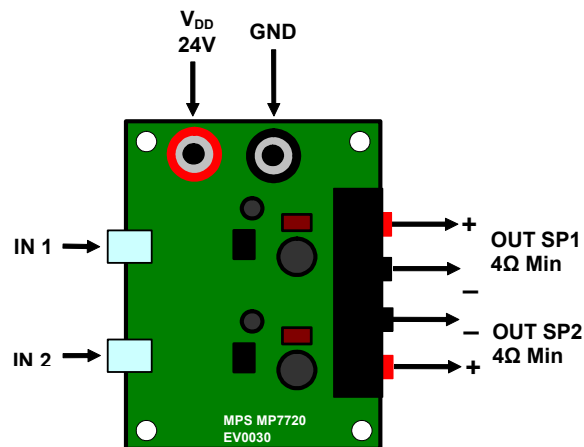
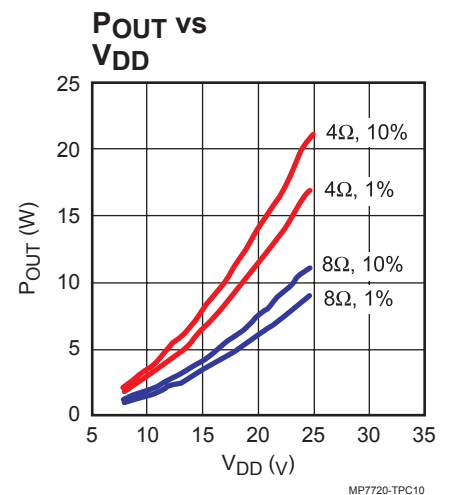
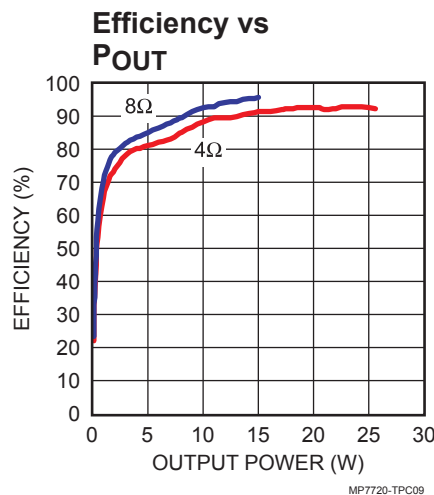
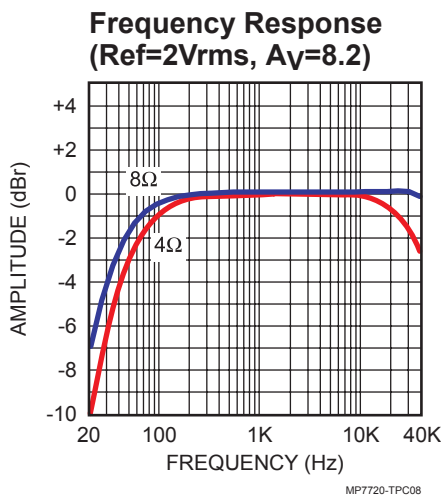
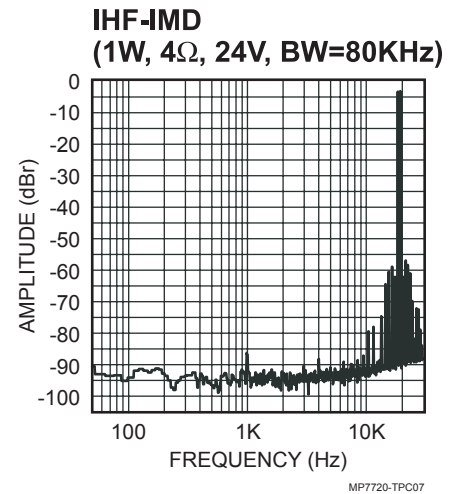
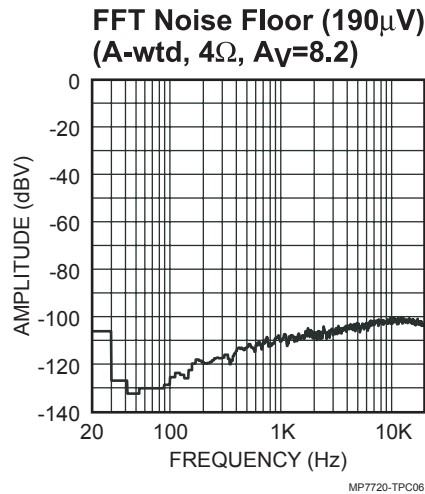
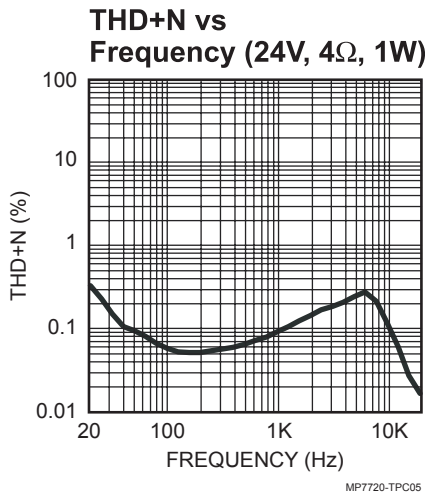
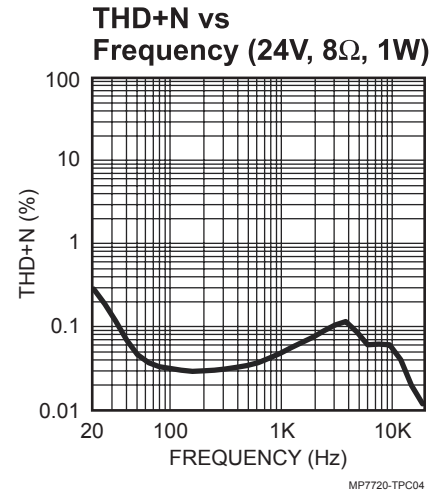
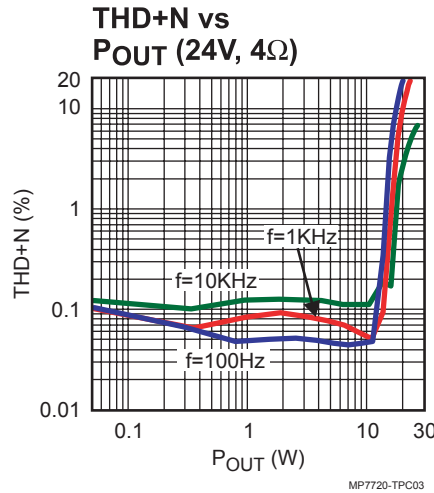
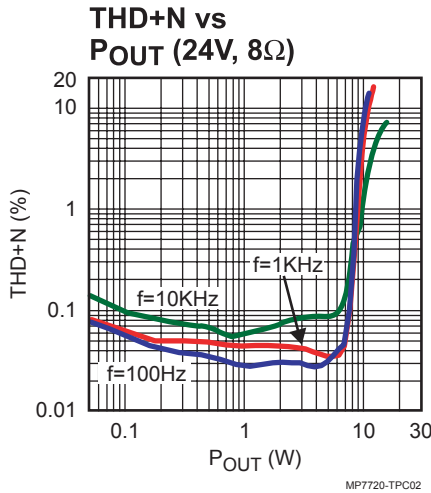

Figure 5—EV0030 Connection Diagram

TYPICAL PERFORMANCE CHARACTERISTICS



QUICK START GUIDE

This board is set up from the factory for 24V operation. To use with a 12V power supply adjust the components as specified in the 12V operation Section 3 below. For more information, consult the MP7720 datasheet.

1. Power Requirements

- a. Power supply: 24V, 6A maximum.
- b. 0V to 1V_{RMS} (max) audio signal source.
- c. Speaker: 4Ω or 8Ω.

2. Setup Condition for 24V Operation

- a. Connect the outputs to the external speakers.
- b. Adjust the power supply to 24V (do not turn on).
- c. Connect the power supply to the V_{DD} terminals.
- d. Set the enable switch to the DISABLE position.
- e. Connect the audio input signal source to the amplifier inputs (IN1, IN2).
- f. Turn on the power supply to apply power to the board.

3. 12V Operation Modifications

- a. Change C11 and C12 to 2.2nF components. Change R13 and R14 to 2kΩ (consult the MP7720 datasheet for more details).
- b. Adjust the power supply to 12V (do not turn on).
- c. Use same procedure for turn on as specified in Section 2.

4. Music Turn-On Sequence

- a. Set the enable switch to the ENABLE position.
- b. Audio should be heard from the speaker(s).

5. Music Turn-Off Sequence

- a. Set the enable switch to the DISABLE position.

NOTICE: The information in this document is subject to change without notice. Please contact MPS for current specifications. Users should warrant and guarantee that third party Intellectual Property rights are not infringed upon when integrating MPS products into any application. MPS will not assume any legal responsibility for any said applications.