

NJG1662MD7

[查询"NJG1662MD7"供应商](#)

■ ABSOLUTE MAXIMUM RATINGS

($T_a=+25^{\circ}\text{C}$, $Z_s=Z_l=50\Omega$)

PARAMETER	SYMBOL	CONDITIONS	RATINGS	UNITS
RF input power	P_{IN}	$V_{DD}=2.7\text{V}$, $V_{CTL}=0\text{V}/1.8\text{V}$ PC1,PC2,PA1,PA2,PB1,PB2	28	dBm
Supply voltage	V_{DD}	VDD terminal	5.0	V
Control voltage	V_{CTL}	VCTL terminal	5.0	V
Power dissipation	P_D	On PCB	1300	mW
Operating temp.	T_{opr}		-40~+85	$^{\circ}\text{C}$
Storage temp.	T_{stg}		-55~+150	$^{\circ}\text{C}$

■ ELECTRICAL CHARACTERISTICS

(General conditions: $T_a=+25^{\circ}\text{C}$, $Z_s=Z_l=50\Omega$, $V_{DD}=2.7\text{V}$, $V_{CTL(L)}=0\text{V}$, $V_{CTL(H)}=1.8\text{V}$, with application circuit)

PARAMETERS	SYMBOL	CONDITIONS	MIN	TYP	MAX	UNITS
Supply voltage	V_{DD}		1.5	2.7	4.5	V
Operating current	I_{DD}	$P_{IN}=0\text{dBm}$	-	16	30	μA
Control voltage (LOW)	$V_{CTL(L)}$		0	-	0.4	V
Control voltage (HIGH)	$V_{CTL(H)}$		1.3	1.8	V_{DD}	V
Control current	I_{CTL}	$f=2\text{GHz}$, $P_{IN}=0\text{dBm}$	-	5	10	μA
Insertion loss 1	LOSS1	$f=1\text{GHz}$, $P_{IN}=0\text{dBm}$	-	0.3	0.45	dB
Insertion loss 2	LOSS2	$f=2\text{GHz}$, $P_{IN}=0\text{dBm}$	-	0.4	0.55	dB
Isolation 1	ISL1	PC1-PA1, PC2-PA2 PC1-PB1, PC2-PB2 $f=1\text{GHz}$, $P_{IN}=0\text{dBm}$	26	28	-	dB
Isolation 2	ISL2	PC1-PA1, PC2-PA2 PC1-PB1, PC2-PB2 $f=2\text{GHz}$, $P_{IN}=0\text{dBm}$	20	22	-	dB
Isolation 3	ISL3	PC1-PA1, PC2-PA2 PC1-PB1, PC2-PB2 $f=2.5\text{GHz}$, $P_{IN}=0\text{dBm}$	18	20	-	dB
Isolation 4	ISL4	PC1-PC2 port $f=2\text{GHz}$, $P_{IN}=0\text{dBm}$	26	28	-	dB
Phase error	PE	$f=2\text{GHz}$, between on paths	-3	0	3	deg
Input power at 0.2dB compression point	$P_{-0.2\text{dB}}$	$f=2\text{GHz}$	20	24	-	dBm
VSWR	VSWR	$f=2\text{GHz}$, On port	-	1.2	1.3	
Switching time	T_{SW}	50% CTL to 10%/90% RF	-	1.5	5.0	μs

■ TERMINAL INFORMATION

No.	SYMBOL	DESCRIPTION
1	GND	Ground terminal. Please connect this terminal with ground plane as close as possible for good RF performance.
2	PA2	This port is connected to PC2 terminal by applying High-level (1.3~4.5V) at VCTL terminal. An external capacitor is required to block DC voltage of internal circuit.
3	PB1	This port is connected to PC1 terminal by applying Low-level (0~0.4V) at VCTL terminal. An external capacitor is required to block DC voltage of internal circuit.
4	GND	Ground terminal. Please connect this terminal with ground plane as close as possible for good RF performance.
5	PB2	This port is connected to PC2 terminal by applying Low-level (0~0.4V) at VCTL terminal. An external capacitor is required to block DC voltage of internal circuit.
6	GND	Ground terminal. Please connect this terminal with ground plane as close as possible for good RF performance.
7	VDD	A supply voltage terminal (1.5~4.5V). Please place a bypass capacitor between this terminal and GND for avoiding RF noise from outside.
8	GND	Ground terminal. Please connect this terminal with ground plane as close as possible for good RF performance.
9	PC2	Common RF port. This port is connected with either of PA2 or PB2. An external capacitor is required to block DC voltage of internal circuit.
10	PC1	Common RF port. This port is connected with either of PA1 or PB1. An external capacitor is required to block DC voltage of internal circuit.
11	GND	Ground terminal. Please connect this terminal with ground plane as close as possible for good RF performance.
12	VCTL	Control signal input terminal. This terminal is set to high-level (1.3V~4.5V) or low-level (0~0.4V).
13	GND	Ground terminal. Please connect this terminal with ground plane as close as possible for good RF performance.
14	PA1	This port is connected to PC1 terminal by applying High-level (1.3~4.5V) at VCTL terminal. An external capacitor is required to block DC voltage of internal circuit.

■ ELECTRICAL CHARACTERISTICS (With Application circuit, Loss of external circuit are excluded)

Insertion Loss vs. Frequency

($V_{DD}=2.7V, V_{CTL}=1.8V$)

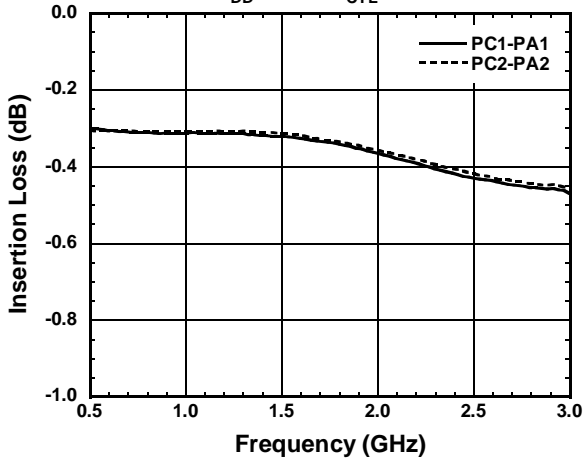

Insertion Loss vs. Frequency

($V_{DD}=2.7V, V_{CTL}=0V$)

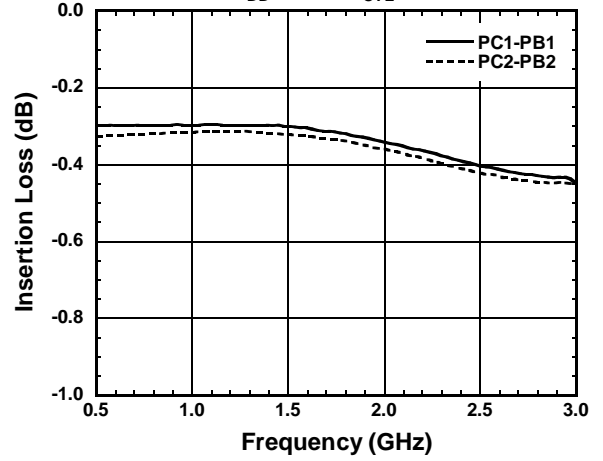

VSWR vs. Frequency

($V_{DD}=2.7V, V_{CTL1}=1.8V$)

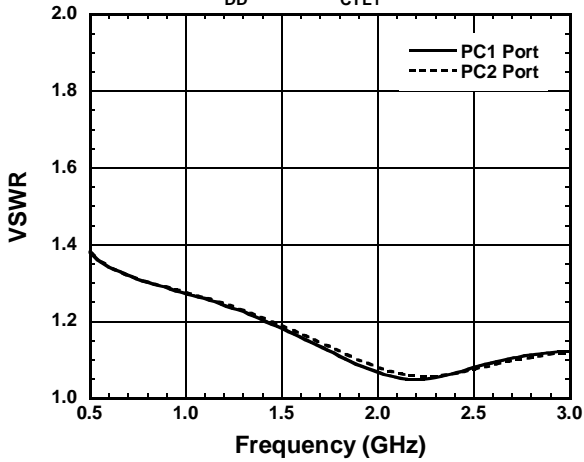

Isolation vs. Frequency

($V_{DD}=2.7V, V_{CTL}=1.8V$)

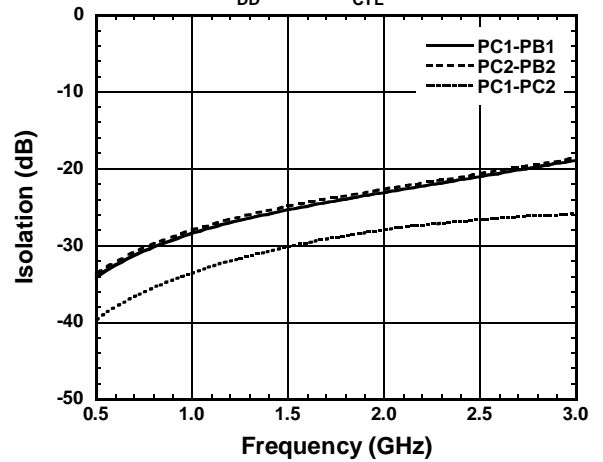

PC1-PA1, PC2-PA2 Phase Error vs. Frequency

($V_{DD}=2.7V, V_{CTL}=1.8V$)

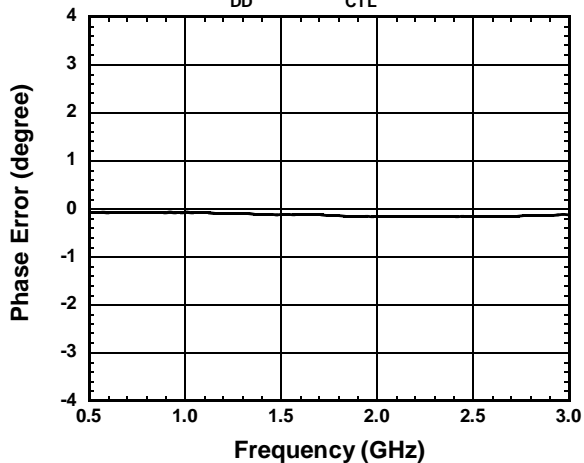

PC1-PA1, PC2-PA2 Phase Error vs. Frequency

($V_{DD}=2.7V, V_{CTL}=1.8V$)

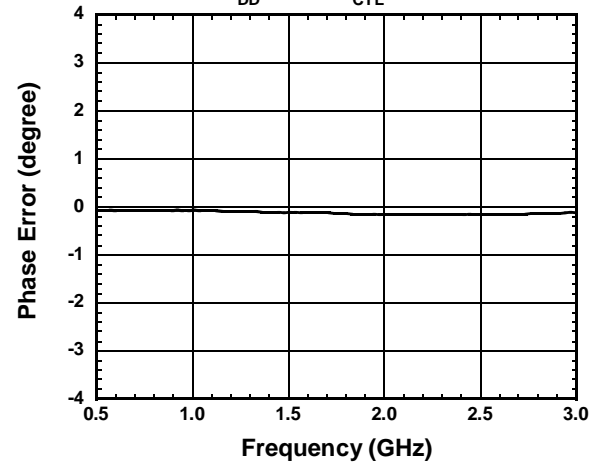

■ ELECTRICAL CHARACTERISTICS (With Application circuit, Loss of external circuit are excluded)

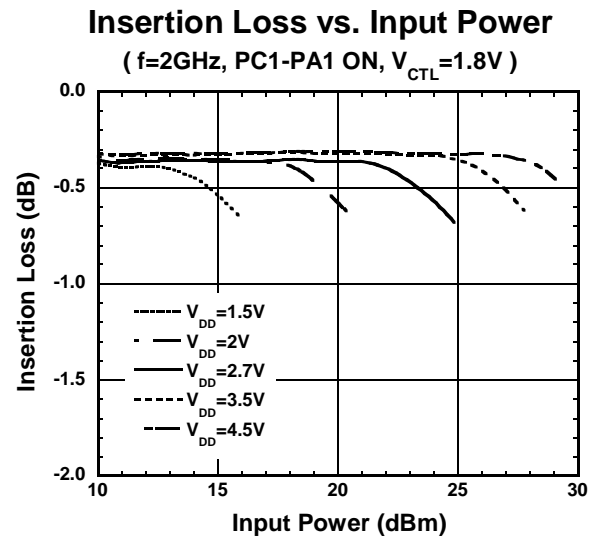
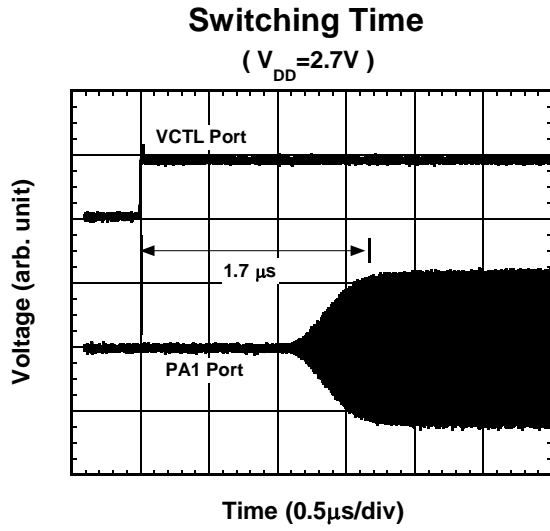

■ ELECTRICAL CHARACTERISTICS (With Application circuit, Loss of external circuit are excluded)

Insertion Loss vs. Ambient Temperature

(PC1-PA1 ON, $V_{DD}=2.7V$, $V_{CTL}=1.8V$)

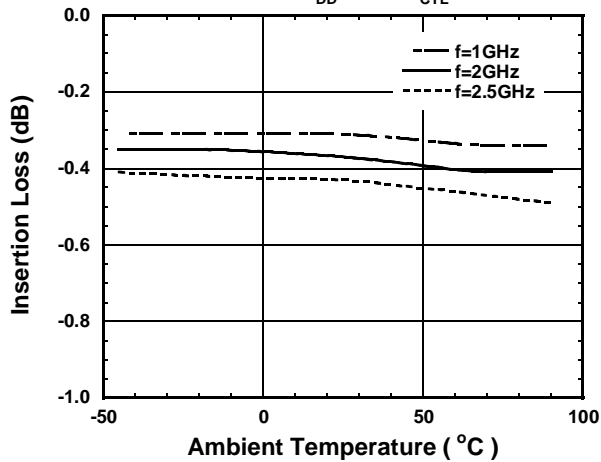

Insertion Loss vs. Frequency

(PC1-PA1 ON, $f=2GHz$, $V_{DD}=2.7V$, $V_{CTL}=1.8V$)

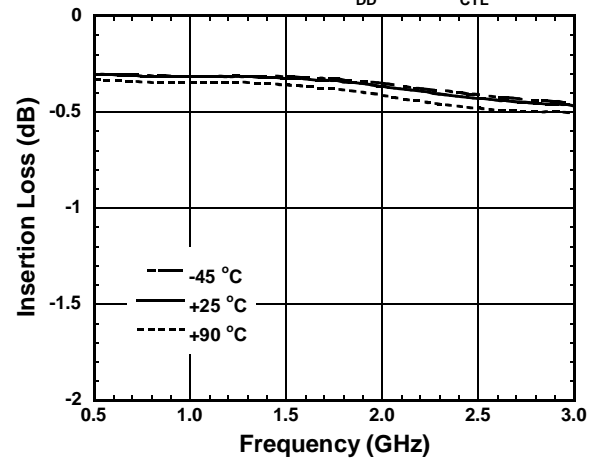

VSWR vs. Ambient Temperature

(PC1-PA1 ON, $V_{DD}=2.7V$, $V_{CTL}=1.8V$)

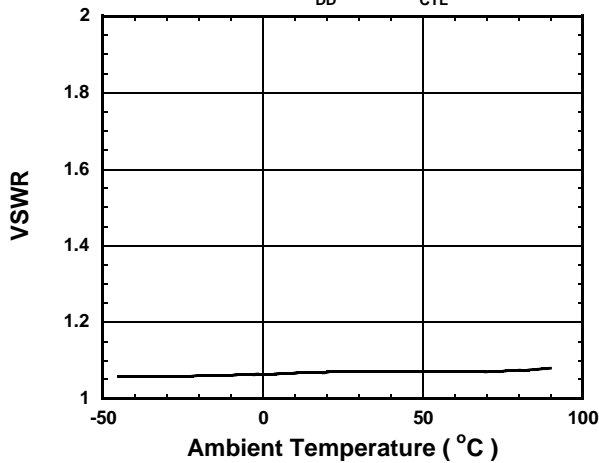

Isolation vs. Ambient Temperature

($f=2GHz$, $V_{DD}=2.7V$, $V_{CTL}=1.8V$)

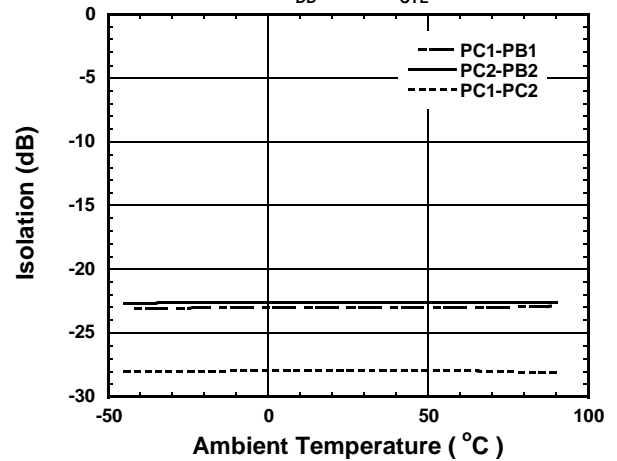

PC1-PA1, PC2-PA2 Phase Error vs. Frequency

($V_{DD}=2.7V$, $V_{CTL}=1.8V$)

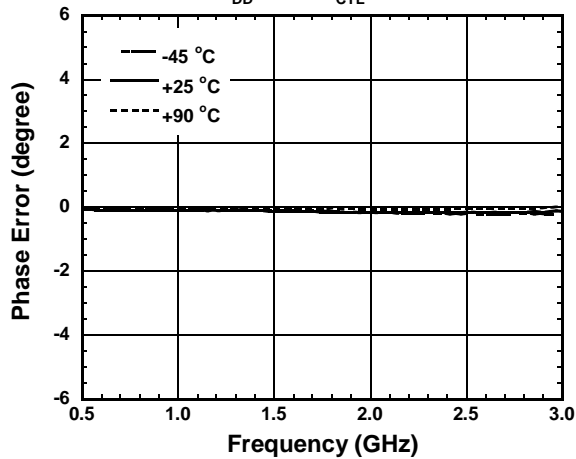

Phase Error vs. Ambient Temperature

($f=2GHz$, $V_{DD}=2.7V$, $V_{CTL(H)}=1.8V$, $V_{CTL(L)}=0V$)

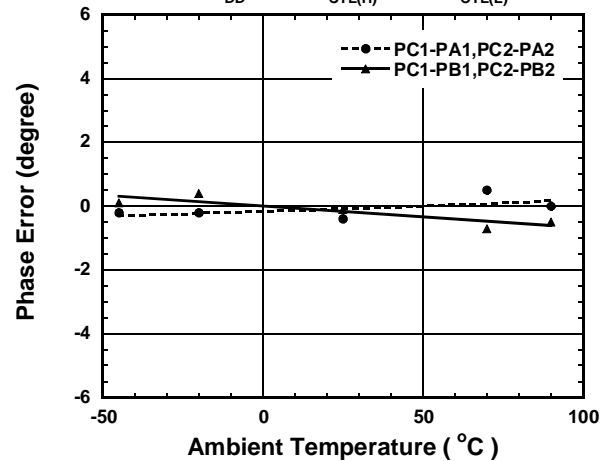

APPLICATION CIRCUIT

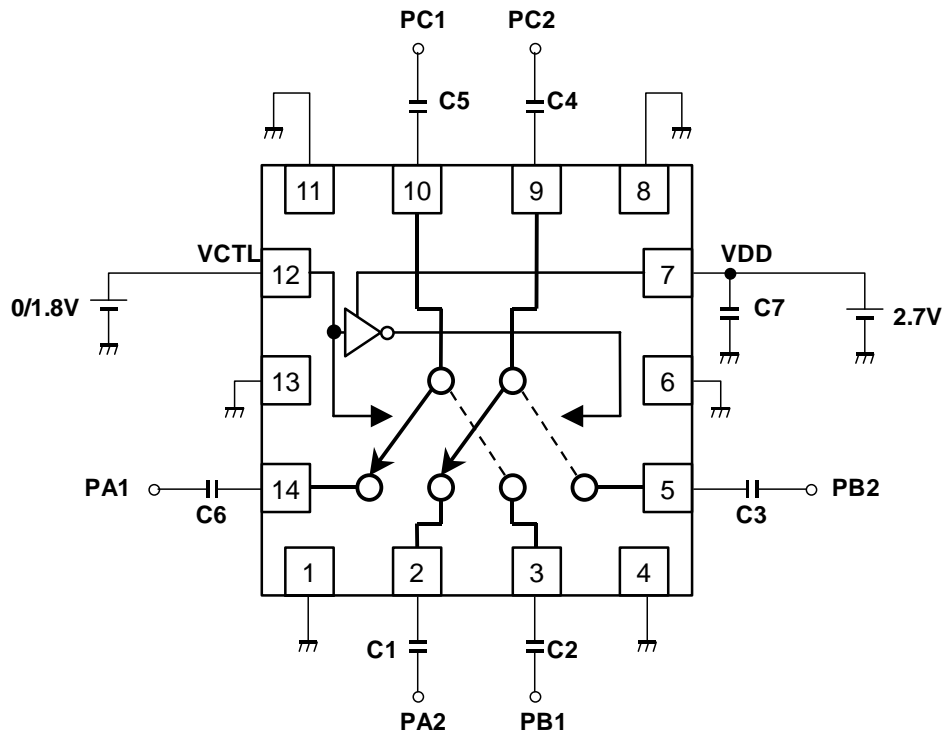

PARTS LIST

Part ID	Value	Notes
C1~C6	56pF	MURATA (GRM15)
C7	1000pF	

TEST PCB LAYOUT

(TOP VIEW)

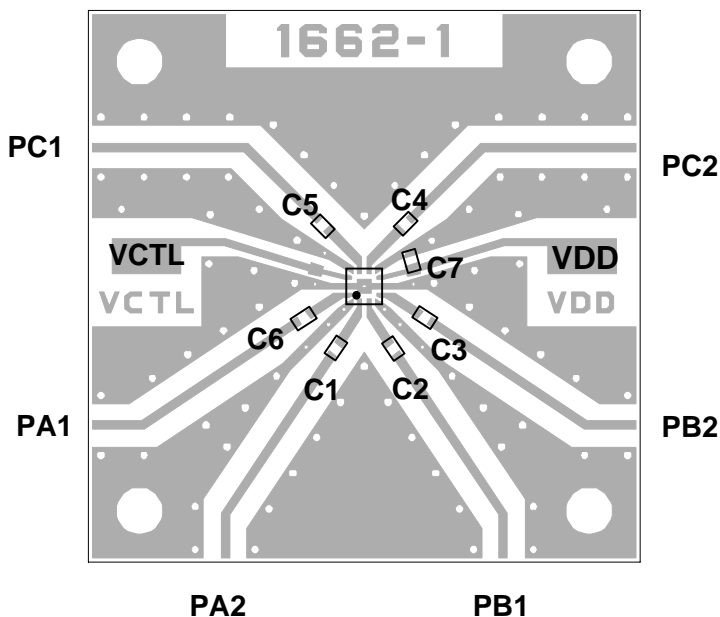

PCB: FR-4, t=0.2mm

Capacitor Size: 1005

Strip Line Width: 0.4mm

PCB Size: 26 x 26mm

Losses of PCB, capacitors and connectors

Frequency (GHz)	Loss (dB)
1.0	0.38
2.0	0.51
2.5	0.55

NJG1662MD7

[查询"NJG1662MD7"供应商](#)

PACKAGE OUTLINE (EQFN14-D7)

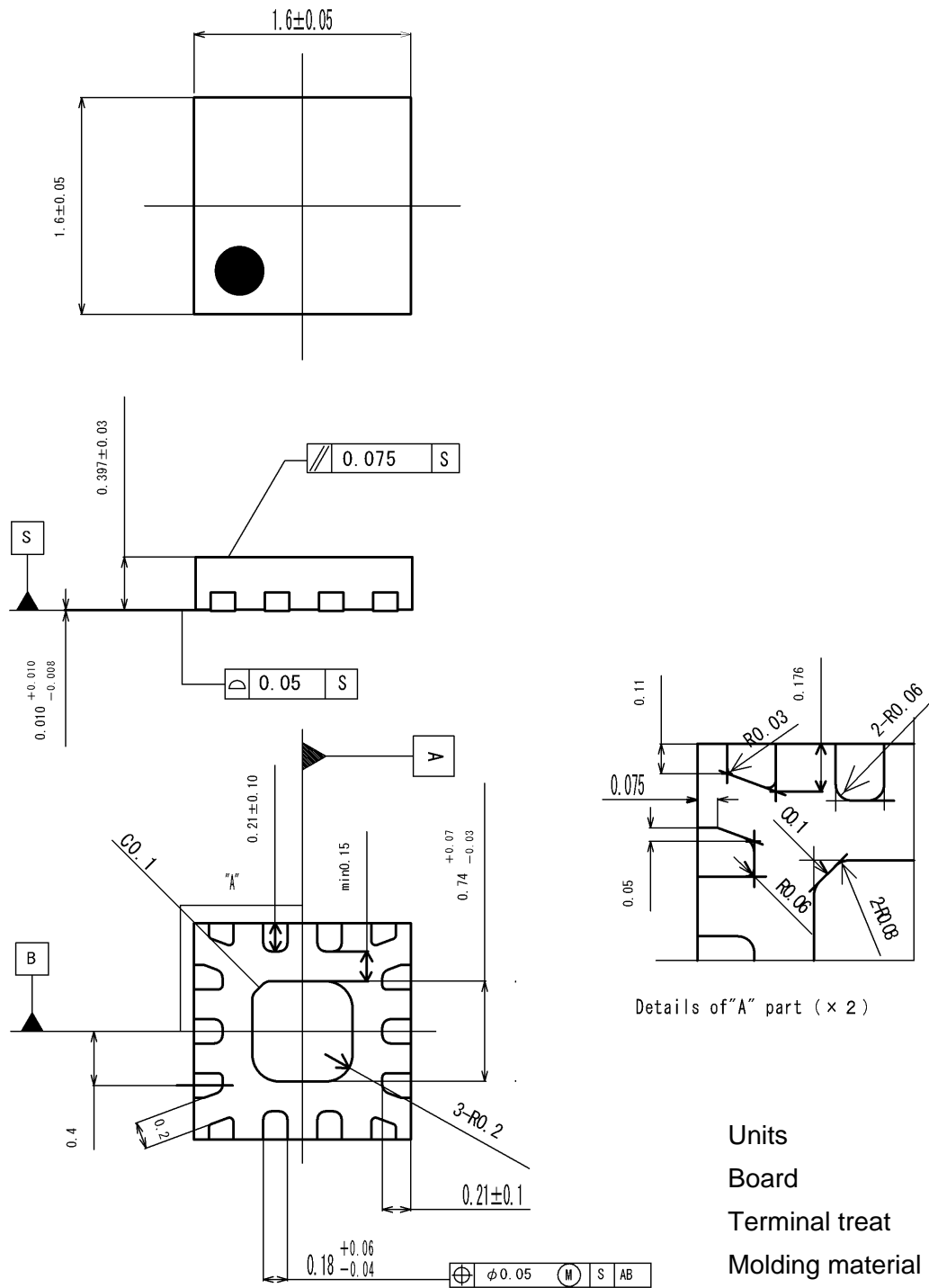

Units : mm
 Board : Cu
 Terminal treat : SnBi
 Molding material : Epoxy resin
 Weight : 3.3mg

Cautions on using this product

This product contains Gallium-Arsenide (GaAs) which is a harmful material.

- Do NOT eat or put into mouth.
- Do NOT dispose in fire or break up this product.
- Do NOT chemically make gas or powder with this product.
- To waste this product, please obey the relating law of your country.

[CAUTION]

The specifications on this databook are only given for information, without any guarantee as regards either mistakes or omissions. The application circuits in this databook are described only to show representative usages of the product and not intended for the guarantee or permission of any right including the industrial rights.

This product may be damaged with electric static discharge (ESD) or spike voltage. Please handle with care to avoid these damages.