

9097250 TOSHIBA (DISCRETE/OPTO)
[查询"2SC2824"供应商](#)

56C 07606 D T-33-07

SILICON NPN EPITAXIAL TYPE (PCT PROCESS)

2SC2824

AUDIO FREQUENCY POWER AMPLIFIER APPLICATIONS.

FEATURES:

- Complementary to 2SA1184.
- Suitable for driver of 60 to 80 watts audio amplifier.
- High breakdown voltage.

MAXIMUM RATINGS (Ta=25°C)

CHARACTERISTIC	SYMBOL	RATING	UNIT
Collector-Base Voltage	VCBO	120	V
Collector-Emitter Voltage	VCEO	120	V
Emitter-Base Voltage	VEBO	5	V
Collector Current	IC	1	A
Base Current	IB	100	mA
Collector Power Dissipation	PC	Ta=25°C	1
		Tc=25°C	15
Junction Temperature	Tj	150	°C
Storage Temperature Range	Tstg	-55~150	°C

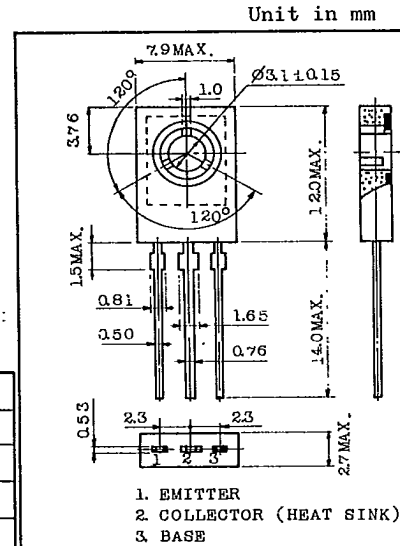

JEDEC TO-126

EIAJ -

TOSHIBA 2-8F1A

Mounting Kit No. AC46C

Weight : 0.72g

ELECTRICAL CHARACTERISTICS (Ta=25°C)

CHARACTERISTIC	SYMBOL	TEST CONDITION	MIN.	TYP.	MAX.	UNIT
Collector Cut-off Current	ICBO	V _{CB} =120V, I _E =0	-	-	100	nA
Emitter Cut-off Current	IEBO	V _{EB} =5V, I _C =0	-	-	100	nA
Collector-Emitter Breakdown Voltage	V(BR)CEO	I _C =10mA, I _B =0	120	-	-	V
Emitter-Base Breakdown Voltage	V(BR)EBO	I _E =1mA, I _C =0	5	-	-	V
DC Current Gain	h _{FE} (Note)	V _{CE} =5V, I _C =100mA	80	-	240	
Collector-Emitter Saturation Voltage	V _{CE(sat)}	I _C =500mA, I _B =50mA	-	0.30	1.0	V
Base-Emitter Voltage	V _{BE}	V _{CE} =5V, I _C =500mA	-	0.78	1.0	V
Transition Frequency	f _T	V _{CE} =5V, I _C =100mA	-	120	-	MHz
Collector Output Capacitance	C _{ob}	V _{CB} =10V, I _E =0, f=1MHz	-	15	-	pF

Note: h_{FE} Classification 0:80~160 Y:120~240

TOSHIBA CORPORATION

9097250 TOSHIBA (DISCRETE/OPTO)
 查询 2SC2824 供应商
2SC2824

56C 07607 0 T-33-07

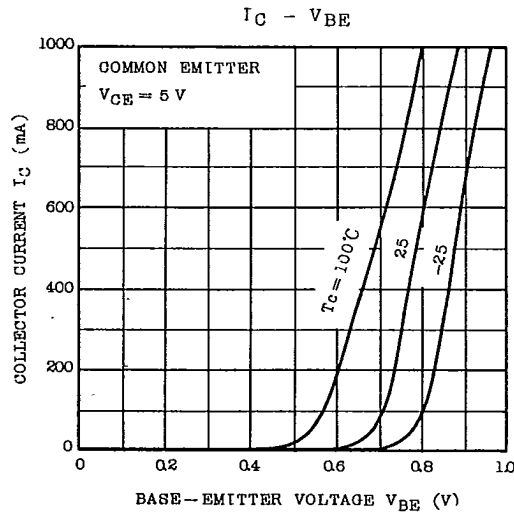
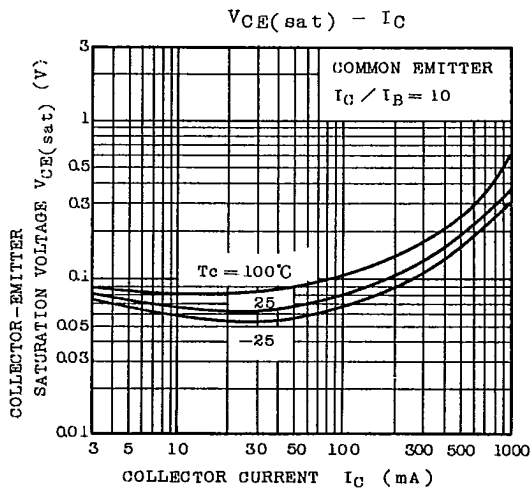
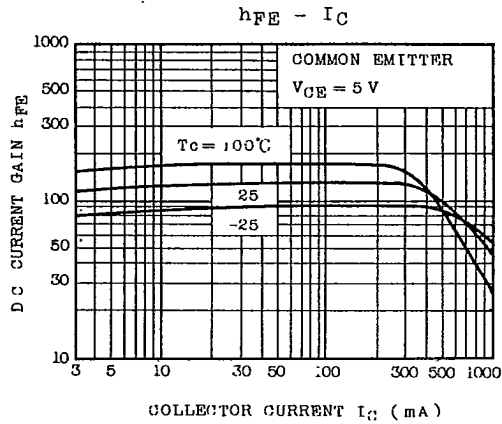
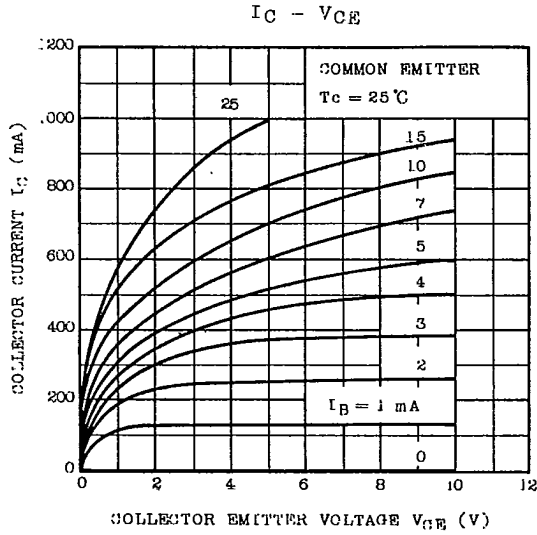

TOSHIBA CORPORATION

查询"2SC2824"供应商

TOSHIBA (DISCRETE/OPTO)

56C 07608

DT-33-07

2SC2824

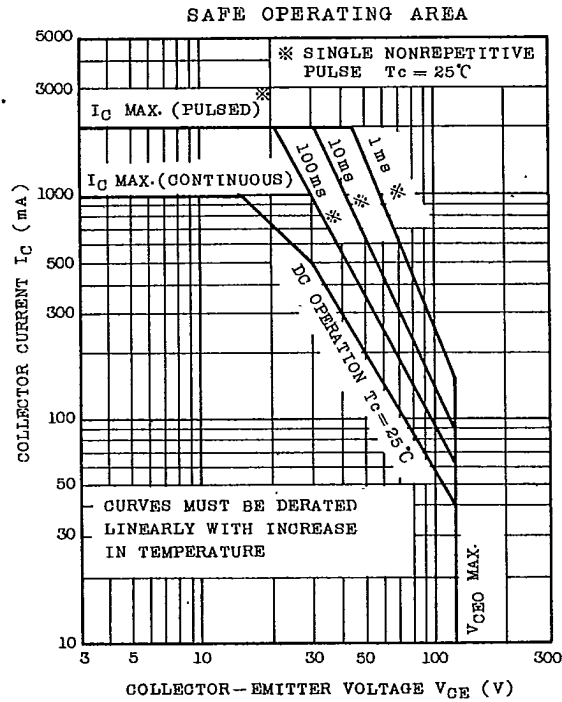
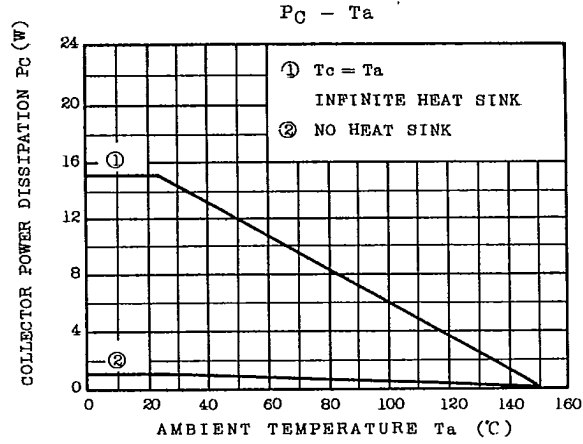

TOSHIBA CORPORATION