

Ignition IGBT

20 Amp, 350 Volt, N-Channel DPAK

This Logic Level Insulated Gate Bipolar Transistor (IGBT) features monolithic circuitry integrating ESD and Overvoltage clamped protection for use in inductive coil drivers applications. Primary uses include Ignition, Direct Fuel Injection, or wherever high voltage and high current switching is required.

Features

- Ideal for Coil-on-Plug and Driver-on-Coil Applications
- DPAK Package Offers Smaller Footprint for Increased Board Space
- Gate-Emitter ESD Protection
- Temperature Compensated Gate-Collector Voltage Clamp Limits Stress Applied to Load
- Integrated ESD Diode Protection
- Low Threshold Voltage for Interfacing Power Loads to Logic or Microprocessor Devices
- Low Saturation Voltage
- High Pulsed Current Capability
- Optional Gate Resistor (R_G) and Gate-Emitter Resistor (R_{GE})
- Pb-Free Package is Available

Applications

- Ignition Systems

MAXIMUM RATINGS ($T_J = 25^\circ\text{C}$ unless otherwise noted)

Rating	Symbol	Value	Unit
Collector-Emitter Voltage	V_{CES}	390	V
Collector-Gate Voltage	V_{CER}	390	V
Gate-Emitter Voltage	V_{GE}	± 15	V
Collector Current-Continuous @ $T_C = 25^\circ\text{C}$ - Pulsed	I_C	20 50	A_{DC} A_{AC}
Continuous Gate Current	I_G	1.0	mA
Transient Gate Current ($t \leq 2$ ms, $f \leq 100$ Hz)	I_G	20	mA
ESD (Charged-Device Model)	ESD	2.0	kV
ESD (Human Body Model) $R = 1500 \Omega$, $C = 100$ pF	ESD	8.0	kV
ESD (Machine Model) $R = 0 \Omega$, $C = 200$ pF	ESD	500	V
Total Power Dissipation @ $T_C = 25^\circ\text{C}$ Derate above 25°C	P_D	125 0.83	W W/ $^\circ\text{C}$
Operating & Storage Temperature Range	T_J, T_{stg}	-55 to +175	$^\circ\text{C}$

Stresses exceeding Maximum Ratings may damage the device. Maximum Ratings are stress ratings only. Functional operation above the Recommended Operating Conditions is not implied. Extended exposure to stresses above the Recommended Operating Conditions may affect device reliability.



ON Semiconductor[®]

<http://onsemi.com>

20 A, 350 V
 $V_{CE(on)} = 1.3 \text{ V @}$
 $I_C = 10 \text{ A, } V_{GE} \geq 4.5 \text{ V}$

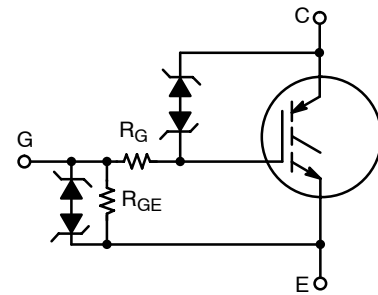

DPAK
CASE 369C
STYLE 7

MARKING DIAGRAM

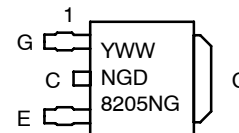

Y = Year
 WW = Work Week
 NGD8205N = Device Code
 G = Pb-Free Package

ORDERING INFORMATION

Device	Package	Shipping [†]
NGD8205NT4	DPAK	2500 / Tape & Reel
NGD8205NT4G	DPAK (Pb-Free)	2500 / Tape & Reel

[†]For information on tape and reel specifications, including part orientation and tape sizes, please refer to our Tape and Reel Packaging Specification Brochure, BRD8011/D.

NGD8205N

UNCLAMPED COLLECTOR-TO-EMITTER AVALANCHE CHARACTERISTICS ($-55^{\circ} \leq T_J \leq 175^{\circ}C$)

Characteristic	Symbol	Value	Unit
Single Pulse Collector-to-Emitter Avalanche Energy $V_{CC} = 50\text{ V}$, $V_{GE} = 5.0\text{ V}$, Pk $I_L = 16.7\text{ A}$, $R_G = 1000\ \Omega$, $L = 1.8\text{ mH}$, Starting $T_J = 25^{\circ}C$ $V_{CC} = 50\text{ V}$, $V_{GE} = 5.0\text{ V}$, Pk $I_L = 14.9\text{ A}$, $R_G = 1000\ \Omega$, $L = 1.8\text{ mH}$, Starting $T_J = 150^{\circ}C$ $V_{CC} = 50\text{ V}$, $V_{GE} = 5.0\text{ V}$, Pk $I_L = 14.1\text{ A}$, $R_G = 1000\ \Omega$, $L = 1.8\text{ mH}$, Starting $T_J = 175^{\circ}C$	E_{AS}	250 200 180	mJ
Reverse Avalanche Energy $V_{CC} = 100\text{ V}$, $V_{GE} = 20\text{ V}$, Pk $I_L = 25.8\text{ A}$, $L = 6.0\text{ mH}$, Starting $T_J = 25^{\circ}C$	$E_{AS(R)}$	2000	mJ

THERMAL CHARACTERISTICS

Thermal Resistance, Junction-to-Case	$R_{\theta JC}$	1.2	$^{\circ}C/W$
Thermal Resistance, Junction-to-Ambient (Note 1)	$R_{\theta JA}$	95	$^{\circ}C/W$
Maximum Temperature for Soldering Purposes, 1/8" from case for 5 seconds (Note 2)	T_L	275	$^{\circ}C$

- When surface mounted to an FR4 board using the minimum recommended pad size.
- For further details, see Soldering and Mounting Techniques Reference Manual: SOLDERRM/D.

ELECTRICAL CHARACTERISTICS

Characteristic	Symbol	Test Conditions	Temperature	Min	Typ	Max	Unit
----------------	--------	-----------------	-------------	-----	-----	-----	------

OFF CHARACTERISTICS

Collector-Emitter Clamp Voltage	BV_{CES}	$I_C = 2.0\text{ mA}$	$T_J = -40^{\circ}C$ to $175^{\circ}C$	325	350	375	V
		$I_C = 10\text{ mA}$	$T_J = -40^{\circ}C$ to $175^{\circ}C$	340	365	390	
Zero Gate Voltage Collector Current	I_{CES}	$V_{GE} = 0\text{ V}$, $V_{CE} = 15\text{ V}$	$T_J = 25^{\circ}C$		0.1	1.0	μA
			$T_J = 25^{\circ}C$	0.5	1.5	10	
			$T_J = 175^{\circ}C$	1.0	25	100*	
Reverse Collector-Emitter Clamp Voltage	$BV_{CES(R)}$	$I_C = -75\text{ mA}$	$T_J = 25^{\circ}C$	30	35	39	V
			$T_J = 175^{\circ}C$	35	39	45*	
			$T_J = -40^{\circ}C$	30	33	37	
Reverse Collector-Emitter Leakage Current	$I_{CES(R)}$	$V_{CE} = -24\text{ V}$	$T_J = 25^{\circ}C$	0.05	0.25	0.5	mA
			$T_J = 175^{\circ}C$	1.0	12.5	25*	
			$T_J = -40^{\circ}C$	0.005	0.03	0.25	
Gate-Emitter Clamp Voltage	BV_{GES}	$I_G = \pm 5.0\text{ mA}$	$T_J = -40^{\circ}C$ to $175^{\circ}C$	12	12.5	14	V
Gate-Emitter Leakage Current	I_{GES}	$V_{GE} = \pm 5.0\text{ V}$	$T_J = -40^{\circ}C$ to $175^{\circ}C$	200	300	350*	μA
Gate Resistor (Optional)	R_G		$T_J = -40^{\circ}C$ to $175^{\circ}C$		70		Ω
Gate-Emitter Resistor	R_{GE}		$T_J = -40^{\circ}C$ to $175^{\circ}C$	14.25	16	25	k Ω

ON CHARACTERISTICS (Note 4)

Gate Threshold Voltage	$V_{GE(th)}$	$I_C = 1.0\text{ mA}$, $V_{GE} = V_{CE}$	$T_J = 25^{\circ}C$	1.5	1.8	2.1	V
			$T_J = 175^{\circ}C$	0.7	1.0	1.3	
			$T_J = -40^{\circ}C$	1.7	2.0	2.3*	
Threshold Temperature Coefficient (Negative)				3.8	4.6	6.0	mV/ $^{\circ}C$

*Maximum Value of Characteristic across Temperature Range.

- Pulse Test: Pulse Width $\leq 300\ \mu S$, Duty Cycle $\leq 2\%$.

NGD8205N

ELECTRICAL CHARACTERISTICS

Characteristic	Symbol	Test Conditions	Temperature	Min	Typ	Max	Unit
ON CHARACTERISTICS (Note 4)							
Collector-to-Emitter On-Voltage	$V_{CE(on)}$	$I_C = 6.5 \text{ A}, V_{GE} = 3.7 \text{ V}$	$T_J = 25^\circ\text{C}$	0.95	1.15	1.35	V
			$T_J = 175^\circ\text{C}$	0.7	0.95	1.15	
			$T_J = -40^\circ\text{C}$	1.0	1.3	1.40	
		$I_C = 9.0 \text{ A}, V_{GE} = 3.9 \text{ V}$	$T_J = 25^\circ\text{C}$	0.95	1.25	1.45	
			$T_J = 175^\circ\text{C}$	0.8	1.05	1.25	
			$T_J = -40^\circ\text{C}$	1.1	1.4	1.5	
		$I_C = 7.5 \text{ A}, V_{GE} = 4.5 \text{ V}$	$T_J = 25^\circ\text{C}$	0.85	1.15	1.4	
			$T_J = 175^\circ\text{C}$	0.7	0.95	1.2	
			$T_J = -40^\circ\text{C}$	1.0	1.3	1.6*	
		$I_C = 10 \text{ A}, V_{GE} = 4.5 \text{ V}$	$T_J = 25^\circ\text{C}$	1.0	1.3	1.6	
			$T_J = 175^\circ\text{C}$	0.8	1.05	1.4	
			$T_J = -40^\circ\text{C}$	1.1	1.4	1.7*	
		$I_C = 15 \text{ A}, V_{GE} = 4.5 \text{ V}$	$T_J = 25^\circ\text{C}$	1.15	1.45	1.7	
			$T_J = 175^\circ\text{C}$	1.0	1.3	1.55	
			$T_J = -40^\circ\text{C}$	1.25	1.55	1.8*	
		$I_C = 20 \text{ A}, V_{GE} = 4.5 \text{ V}$	$T_J = 25^\circ\text{C}$	1.3	1.6	1.9	
			$T_J = 175^\circ\text{C}$	1.2	1.5	1.8	
			$T_J = -40^\circ\text{C}$	1.4	1.75	2.0*	
Forward Transconductance	gfs	$I_C = 6.0 \text{ A}, V_{CE} = 5.0 \text{ V}$	$T_J = 25^\circ\text{C}$	10	18	25	Mhos

DYNAMIC CHARACTERISTICS

Input Capacitance	C_{ISS}	$f = 10 \text{ kHz}, V_{CE} = 25 \text{ V}$	$T_J = 25^\circ\text{C}$	1100	1300	1500	pF
Output Capacitance	C_{OSS}			70	80	90	
Transfer Capacitance	C_{RSS}			18	20	22	

SWITCHING CHARACTERISTICS

Turn-Off Delay Time (Resistive)	$t_{d(off)}$	$V_{CC} = 300 \text{ V}, I_C = 9.0 \text{ A}$ $R_G = 1.0 \text{ k}\Omega, R_L = 33 \Omega,$ $V_{GE} = 5.0 \text{ V}$	$T_J = 25^\circ\text{C}$	6.0	8.0	10	μSec
Fall Time (Resistive)	t_f		$T_J = 175^\circ\text{C}$	6.0	8.0	10	
Turn-Off Delay Time (Inductive)	$t_{d(off)}$	$V_{CC} = 300 \text{ V}, I_C = 9.0 \text{ A}$ $R_G = 1.0 \text{ k}\Omega,$ $L = 300 \mu\text{H}, V_{GE} = 5.0 \text{ V}$	$T_J = 25^\circ\text{C}$	4.0	6.0	8.0	
Fall Time (Inductive)	t_f		$T_J = 175^\circ\text{C}$	8.0	10.5	14	
Turn-On Delay Time	$t_{d(on)}$	$V_{CC} = 14 \text{ V}, I_C = 9.0 \text{ A}$ $R_G = 1.0 \text{ k}\Omega, R_L = 1.5 \Omega,$ $V_{GE} = 5.0 \text{ V}$	$T_J = 25^\circ\text{C}$	3.0	5.0	7.0	
Rise Time	t_r		$T_J = 175^\circ\text{C}$	5.0	7.0	10	
			$T_J = 25^\circ\text{C}$	1.0	1.5	2.0	
			$T_J = 175^\circ\text{C}$	1.0	1.5	2.0	
			$T_J = 25^\circ\text{C}$	4.0	6.0	8.0	
			$T_J = 175^\circ\text{C}$	3.0	5.0	7.0	

*Maximum Value of Characteristic across Temperature Range.

4. Pulse Test: Pulse Width $\leq 300 \mu\text{S}$, Duty Cycle $\leq 2\%$.

TYPICAL ELECTRICAL CHARACTERISTICS

[查询"NGD8205NT4G"供应商](#)

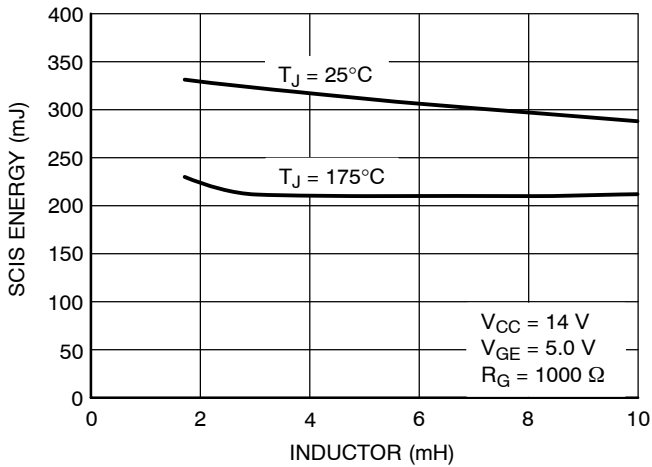

Figure 1. Self Clamped Inductive Switching

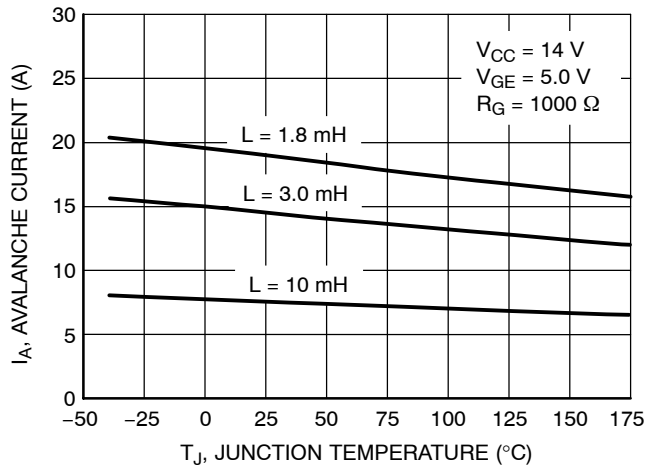

Figure 2. Open Secondary Avalanche Current vs. Temperature

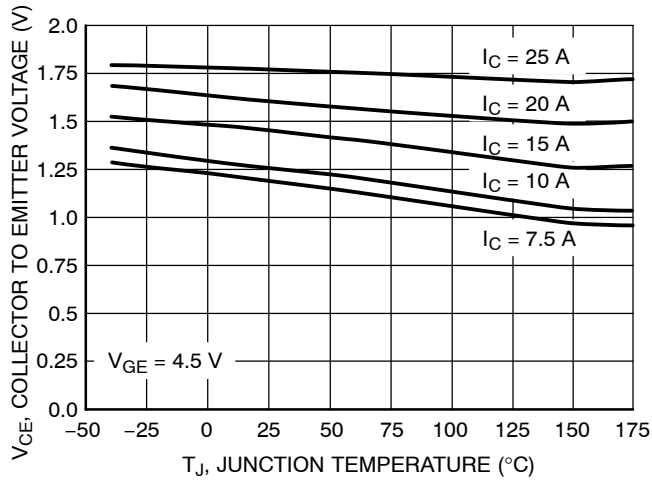

Figure 3. Collector-to-Emitter Voltage vs. Junction Temperature

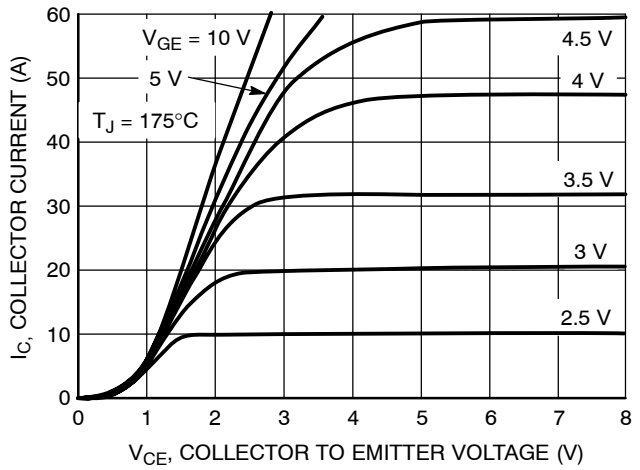

Figure 4. Collector Current vs. Collector-to-Emitter Voltage

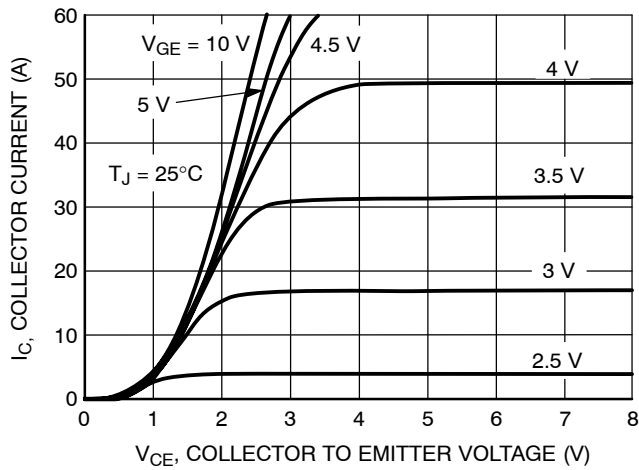

Figure 5. Collector Current vs. Collector-to-Emitter Voltage

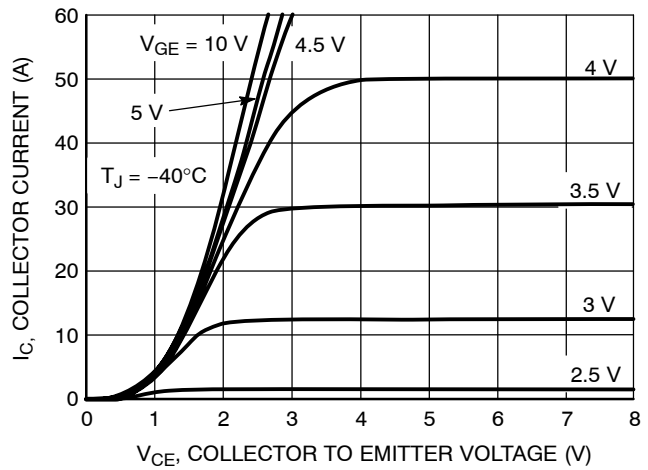

Figure 6. Collector Current vs. Collector-to-Emitter Voltage

TYPICAL ELECTRICAL CHARACTERISTICS

[查询"NGD8205NT4G"供应商](#)

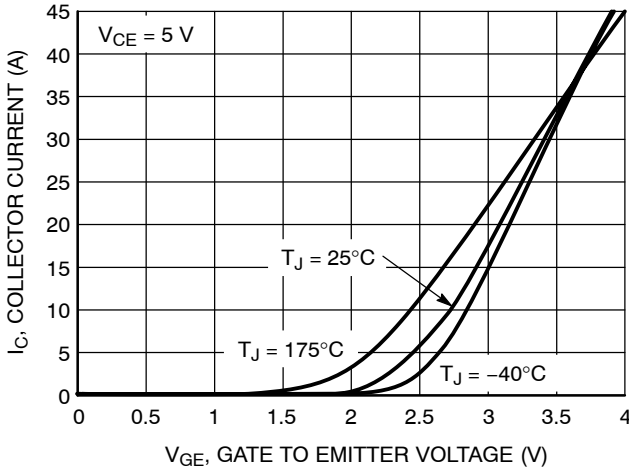

Figure 7. Transfer Characteristics

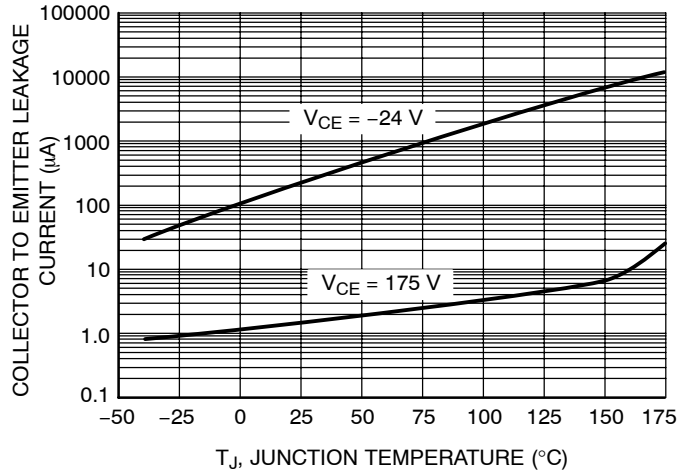

Figure 8. Collector-to-Emitter Leakage Current vs. Temperature

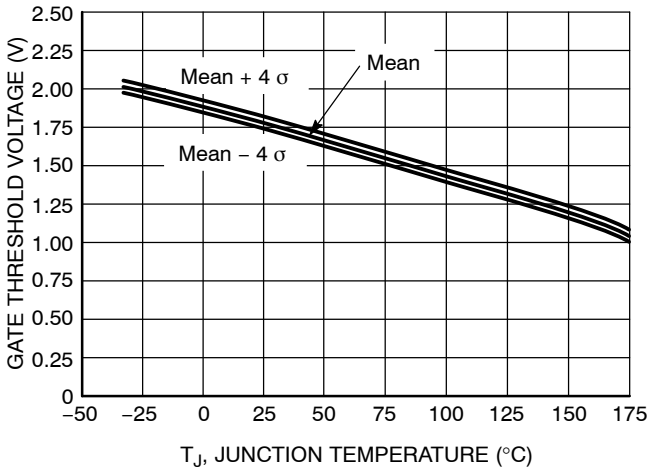

Figure 9. Gate Threshold Voltage vs. Temperature

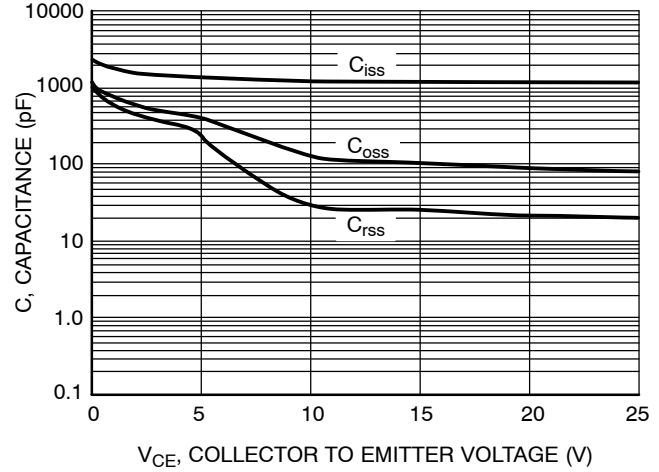

Figure 10. Capacitance vs. Collector-to-Emitter Voltage

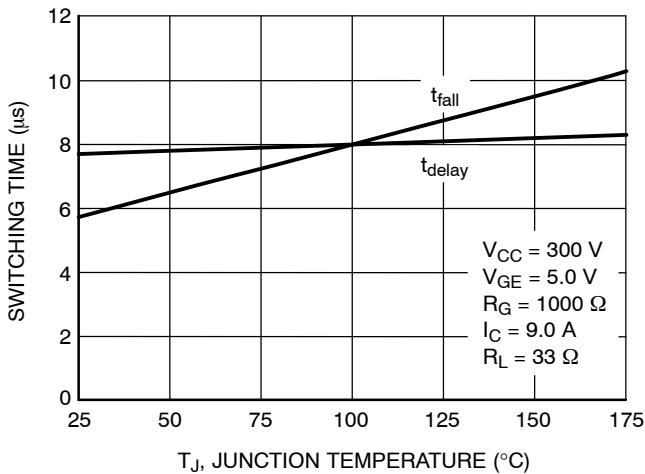

Figure 11. Resistive Switching Fall Time vs. Temperature

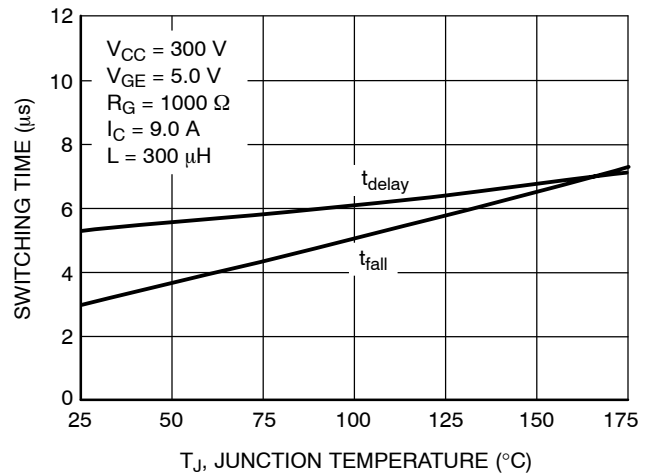

Figure 12. Inductive Switching Fall Time vs. Temperature

查询"NGD8205NT4G"供应商

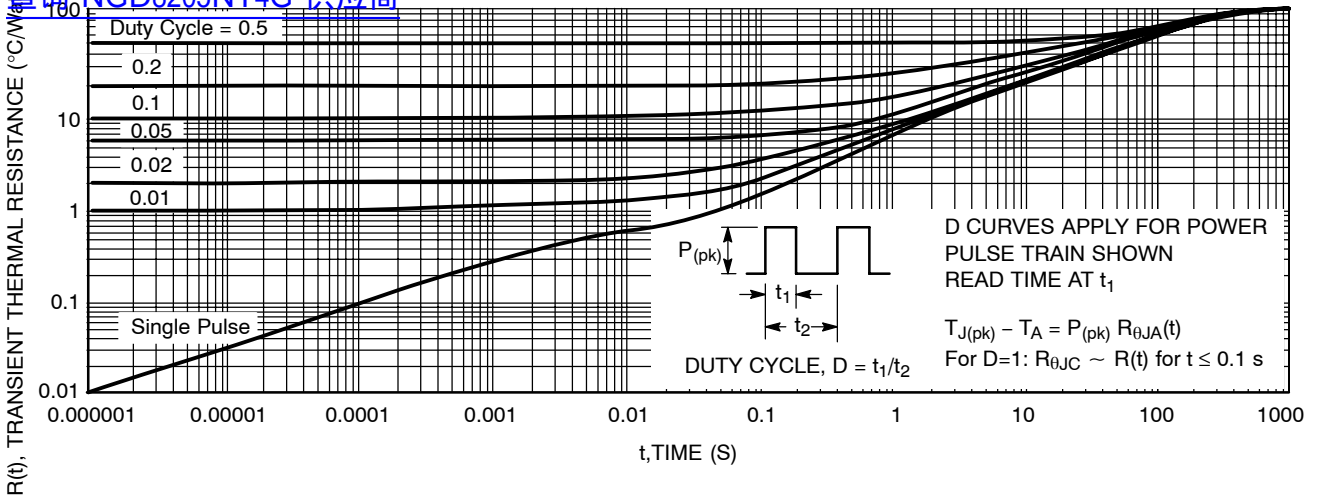

Figure 13. Minimum Pad Transient Thermal Resistance (Non-normalized Junction-to-Ambient)

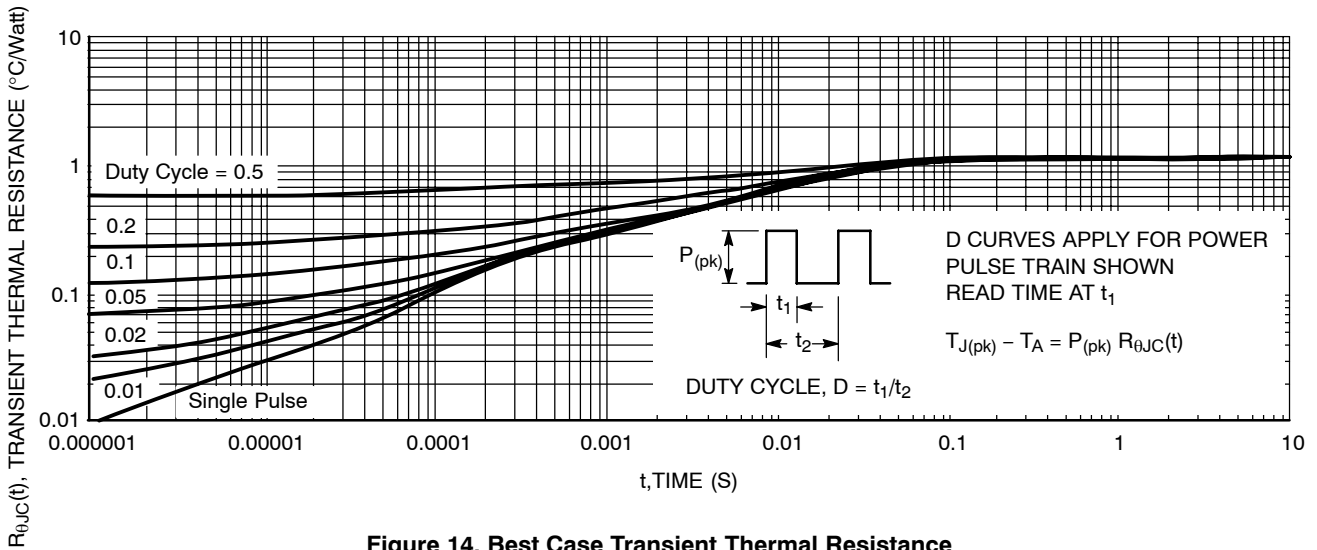

Figure 14. Best Case Transient Thermal Resistance (Non-normalized Junction-to-Case Mounted on Cold Plate)

NGD8205N

查询"NGD8205NT4G"供应商

PACKAGE DIMENSIONS

DPAK
CASE 369C-01
ISSUE O

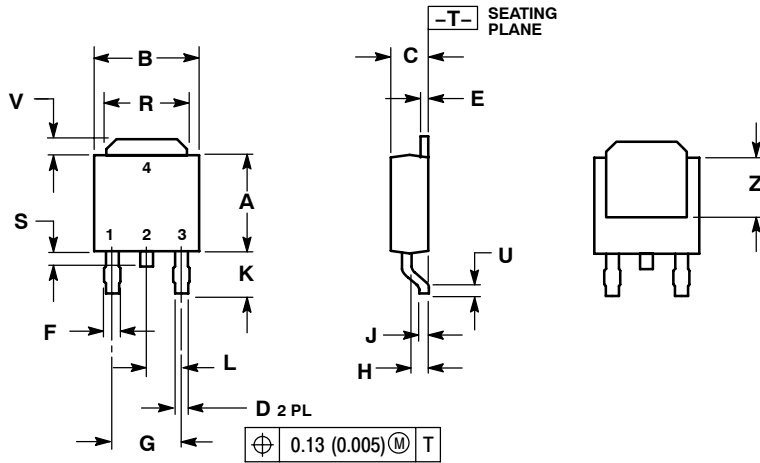

NOTES:
1. DIMENSIONING AND TOLERANCING PER ANSI Y14.5M, 1982.
2. CONTROLLING DIMENSION: INCH.

DIM	INCHES		MILLIMETERS	
	MIN	MAX	MIN	MAX
A	0.235	0.245	5.97	6.22
B	0.250	0.265	6.35	6.73
C	0.086	0.094	2.19	2.38
D	0.027	0.035	0.69	0.88
E	0.018	0.023	0.46	0.58
F	0.037	0.045	0.94	1.14
G	0.180 BSC		4.58 BSC	
H	0.034	0.040	0.87	1.01
J	0.018	0.023	0.46	0.58
K	0.102	0.114	2.60	2.89
L	0.090 BSC		2.29 BSC	
R	0.180	0.215	4.57	5.45
S	0.025	0.040	0.63	1.01
U	0.020	---	0.51	---
V	0.035	0.050	0.89	1.27
Z	0.155	---	3.93	---

STYLE 7:
PIN 1. GATE
2. COLLECTOR
3. EMITTER
4. COLLECTOR

SOLDERING FOOTPRINT*

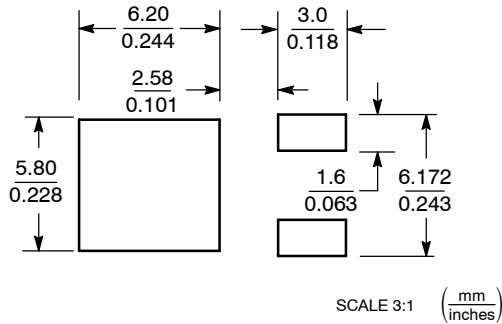

*For additional information on our Pb-Free strategy and soldering details, please download the ON Semiconductor Soldering and Mounting Techniques Reference Manual, SOLDERRM/D.

ON Semiconductor and are registered trademarks of Semiconductor Components Industries, LLC (SCILLC). SCILLC reserves the right to make changes without further notice to any products herein. SCILLC makes no warranty, representation or guarantee regarding the suitability of its products for any particular purpose, nor does SCILLC assume any liability arising out of the application or use of any product or circuit, and specifically disclaims any and all liability, including without limitation special, consequential or incidental damages. "Typical" parameters which may be provided in SCILLC data sheets and/or specifications can and do vary in different applications and actual performance may vary over time. All operating parameters, including "Typicals" must be validated for each customer application by customer's technical experts. SCILLC does not convey any license under its patent rights nor the rights of others. SCILLC products are not designed, intended, or authorized for use as components in systems intended for surgical implant into the body, or other applications intended to support or sustain life, or for any other application in which the failure of the SCILLC product could create a situation where personal injury or death may occur. Should Buyer purchase or use SCILLC products for any such unintended or unauthorized application, Buyer shall indemnify and hold SCILLC and its officers, employees, subsidiaries, affiliates, and distributors harmless against all claims, costs, damages, and expenses, and reasonable attorney fees arising out of, directly or indirectly, any claim of personal injury or death associated with such unintended or unauthorized use, even if such claim alleges that SCILLC was negligent regarding the design or manufacture of the part. SCILLC is an Equal Opportunity/Affirmative Action Employer. This literature is subject to all applicable copyright laws and is not for resale in any manner.

PUBLICATION ORDERING INFORMATION

LITERATURE FULFILLMENT:
Literature Distribution Center for ON Semiconductor
P.O. Box 5163, Denver, Colorado 80217 USA
Phone: 303-675-2175 or 800-344-3860 Toll Free USA/Canada
Fax: 303-675-2176 or 800-344-3867 Toll Free USA/Canada
Email: orderlit@onsemi.com

N. American Technical Support: 800-282-9855 Toll Free
USA/Canada
Europe, Middle East and Africa Technical Support:
Phone: 421 33 790 2910
Japan Customer Focus Center
Phone: 81-3-5773-3850

ON Semiconductor Website: www.onsemi.com
Order Literature: <http://www.onsemi.com/orderlit>

For additional information, please contact your local Sales Representative