

LP3972

Power Management Unit for Advanced Application Processors

General Description

The LP3972 is a multi-function, programmable Power Management Unit, designed especially for advanced application processors. The LP3972 is optimized for low power handheld applications and provides 6 low dropout, low noise linear regulators, three DC/DC magnetic buck regulators, a back-up battery charger and two GPIO's. A high speed serial interface is included to program individual regulator output voltages as well as on/off control.

Key Specifications

Buck Regulators

- Programmable V_{OUT} from 0.725 to 3.3V
- Up to 95% efficiency
- Up to 1.6A output current
- $\pm 3\%$ output voltage accuracy

LDO's

- Programmable V_{OUT} of 1.0V–3.3V
- $\pm 3\%$ output voltage accuracy
- 150/300/400 mA output currents
 - LDO RTC 30 mA
 - LDO 1 300 mA
 - LDO 2 150 mA
 - LDO 3 150 mA
 - LDO 4 150 mA
 - LDO 5 400 mA

- 100 mV (typ) dropout

Features

- Compatible with advanced applications processors requiring DVM (Dynamic Voltage Management)
- Three buck regulators for powering high current processor functions or I/O's
- 6 LDO's for powering RTC, peripherals, and I/O's
- Backup battery charger with automatic switch for lithium-manganese coin cell batteries and Super capacitors
- I²C compatible high speed serial interface
- Software control of regulator functions and settings
- Precision internal reference
- Thermal overload protection
- Current overload protection
- Tiny 40-pin 5x5 mm LLP package

Applications

- PDA phones
- Smart phones
- Personal Media Players
- Digital cameras
- Application processors
 - Marvell PXA
 - Freescale
 - Samsung

Simplified Application Circuit

[查询"LP3972SQ-A514"供应商](#)

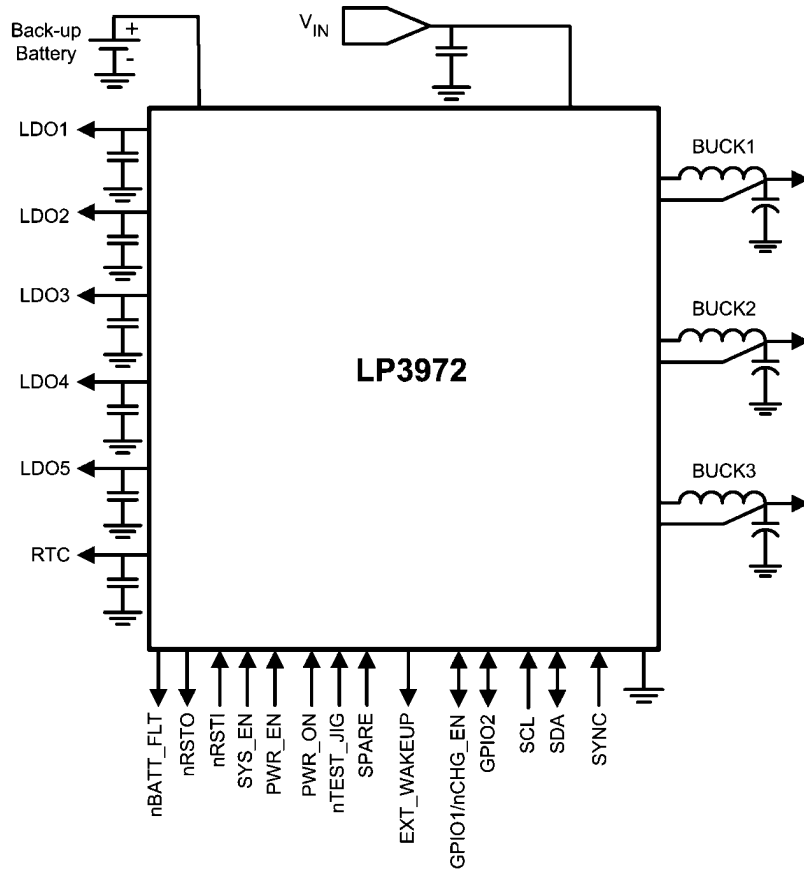

20207601

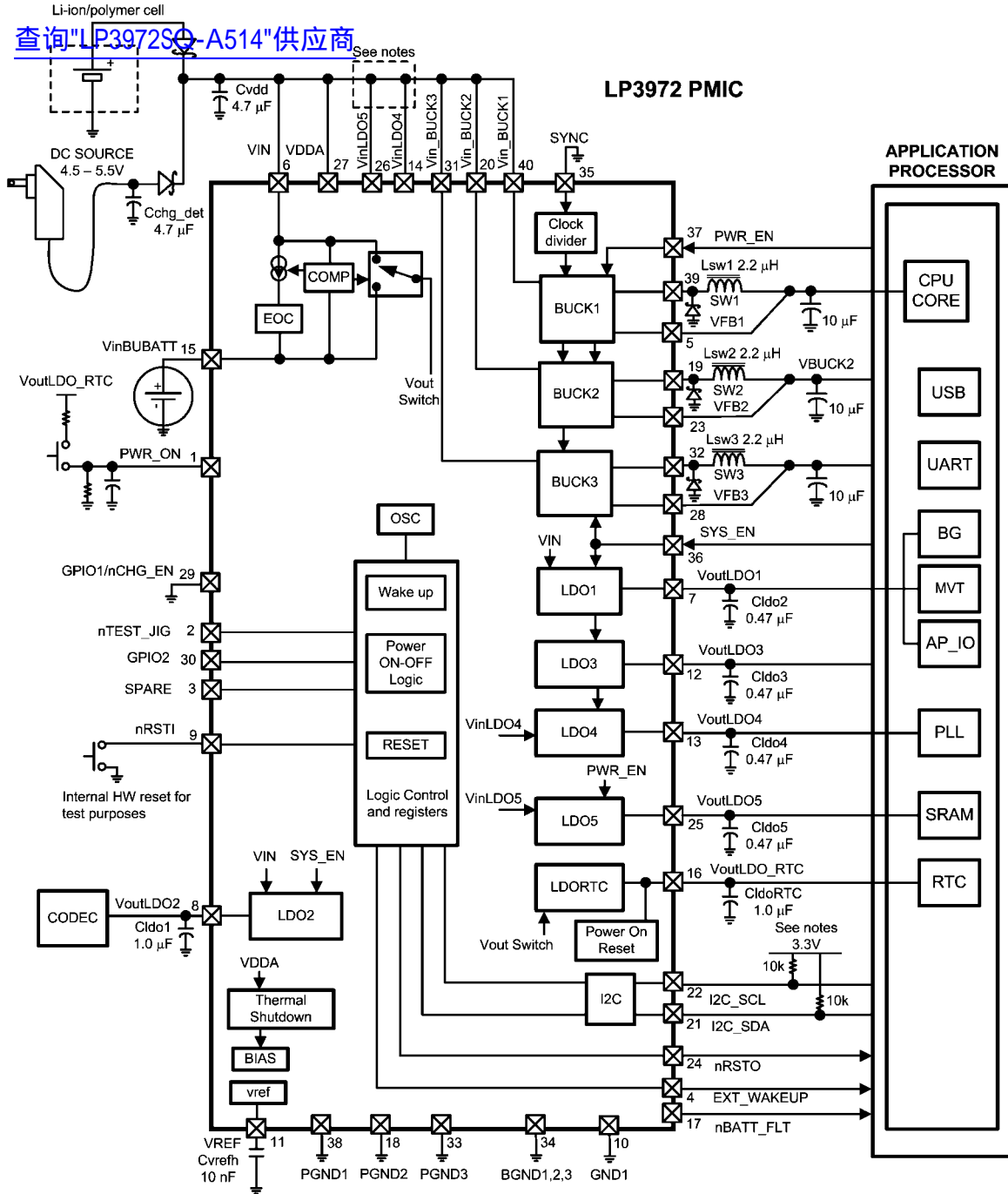

- The I²C lines are pulled up via a I/O source
- V_{IN}LDO4, 5 can either be powered from main battery source, or by a buck regulator or V_{IN}.

20207628

Connection Diagrams and Package Mark Information

[查询"LP3972SQ-A514"供应商](#)

40-Pin Leadless Leadframe Package
NS Package Number SQF40A

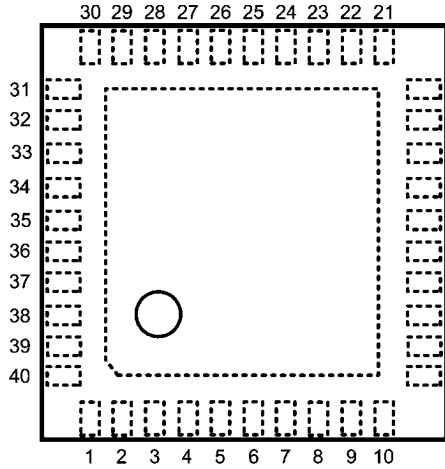

Top View

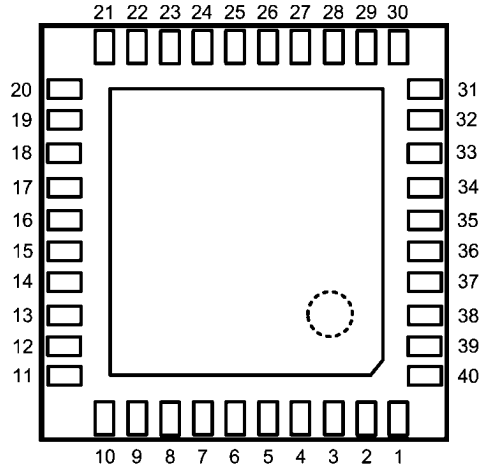

Bottom View

Note: Circle marks pin 1 position.

20207602

Package Mark

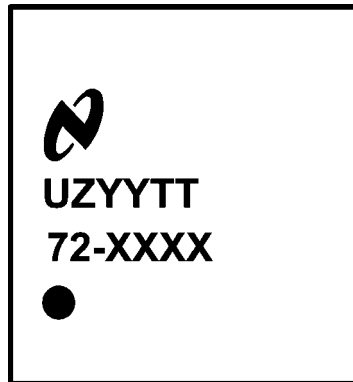

Top View

20207604

Note: The actual physical placement of the package marking will vary from part to part.

(*) UZTTY format: 'U' — wafer fab code; 'Z' — assembly code; 'XY' 2 digit date code; 'TT' — die run code.

See http://www.national.com/quality/markings_conversion.html for more information on marking information.

Ordering Information

[查询"LP3972SQ-A514"供应商](#)

| Voltage Option | Order Number | Package Type | NSC Package Drawing | Package Marking | Supplied As |
|----------------|----------------|--------------|---------------------|-----------------|------------------|
| Voltage A514 | LP3972SQ-A514 | 40 lead LLP | SQF040A | 72-A514 | 1000 tape & reel |
| Voltage A514 | LP3972SQX-A514 | 40 lead LLP | SQF040A | 72-A514 | 4500 tape & reel |
| Voltage A413 | LP3972SQ-A413 | 40 lead LLP | SQF040A | 72-A413 | 1000 tape & reel |
| Voltage A413 | LP3972SQX-A413 | 40 lead LLP | SQF040A | 72-A413 | 4500 tape & reel |
| Voltage E514 | LP3972SQ-E514 | 40 lead LLP | SQF040A | 72-E514 | 1000 tape & reel |
| Voltage E514 | LP3972SQX-E514 | 40 lead LLP | SQF040A | 72-E514 | 4500 tape & reel |
| Voltage I514 | LP3972SQ-I514 | 40 lead LLP | SQF040A | 72-I514 | 1000 tape & reel |
| Voltage I514 | LP3972SQX-I514 | 40 lead LLP | SQF040A | 72-I514 | 4500 tape & reel |

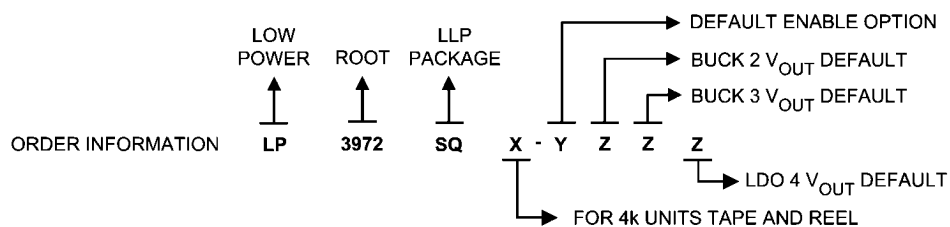

20207605

Default V_{OUT} Coding

| Z | Default V _{OUT} |
|---|--------------------------|
| 0 | 1.3 |
| 1 | 1.8 |
| 2 | 2.5 |
| 3 | 2.8 |
| 4 | 3.0 |
| 5 | 3.3 |
| 6 | 1.0 |
| 7 | 1.4 |
| 8 | 1.2 |
| 9 | 1.25 |

Pin Descriptions

查询"LP3972SQ-A514"供应商

| Pin # | Name | I/O | Type | Description |
|-------|--------------------------|-----|------|---|
| 1 | PWR_ON | I | D | This is an active HI push button input which can be used to signal PWR_ON and PWR_OFF events to the CPU by controlling the ext_wakup [pin4] and select contents of register 8H'88 |
| 2 | nTEST_JIG | I | D | This is an active LOW input signal used for detecting an external HW event. The response is seen in the ext_wakup [pin4] and select contents of register 8H'88 |
| 3 | SPARE | I | D | This is an input signal used for detecting a external HW event. The response is seen in the ext_wakup [pin4] and select contents of register 8H'88. The polarity on this pin is assignable |
| 4 | EXT_WAKEUP | O | D | This pin generates a single 10mS pulse output to CPU in response to input from pin[s] 1, 2, and 3. Flags CPU to interrogate register 8H'88 |
| 5 | FB1 | I | A | Buck1 input feedback terminal |
| 6 | V _{IN} | I | PWR | Battery Input (Internal circuitry and LDO1-3 power input) |
| 7 | V _{OUT} LDO1 | O | PWR | LDO1 output |
| 8 | V _{OUT} LDO2 | O | PWR | LDO2 output |
| 9 | nRSTI | I | D | Active low Reset pin. Signal used to reset the IC (by default is pulled high internally). Typically a push button reset. |
| 10 | GND1 | G | G | Ground |
| 11 | VREF | O | A | Bypass Cap. for the high internal impedance reference. |
| 12 | V _{OUT} LDO3 | O | PWR | LDO3 output |
| 13 | V _{OUT} LDO4 | O | PWR | LDO4 output |
| 14 | V _{IN} LDO4 | I | PWR | Power input to LDO4, this can be connected to either from a 1.8V supply to main Battery supply. |
| 15 | V _{IN} BUBATT | I | PWR | Back Up Battery input supply. |
| 16 | V _{OUT} LDO_RTC | O | PWR | LDO_RTC output supply to the RTC of the application processor. |
| 17 | nBATT_FLT | O | D | Main Battery fault output, indicates the main battery is low (discharged) or the dc source has been removed from the system. This gives the processor an indicator that the power will shut down. During this time the processor will operate from the back up coin cell. |
| 18 | PGND2 | G | G | Buck2 NMOS Power Ground |
| 19 | SW2 | O | PWR | Buck2 switcher output |
| 20 | V _{IN} Buck2 | I | PWR | Battery input power to Buck2 |
| 21 | SDA | I/O | D | I ² C Data (Bidirectional) |
| 22 | SCL | I | D | I ² C Clock |
| 23 | FB2 | I | A | Buck2 input feedback terminal |
| 24 | nRSTO | O | D | Reset output from the PMIC to the processor |
| 25 | V _{OUT} LDO5 | O | PWR | LDO5 output |
| 26 | V _{IN} LDO5 | I | PWR | Power input to LDO5, this can be connected to V _{IN} or to a separate 1.8V supply. |
| 27 | VDDA | I | PWR | Analog Power for VREF, BIAS |
| 28 | FB3 | I | A | Buck3 Feedback |
| 29 | GPIO1 / nCHG_EN | I/O | D | General Purpose I/O / Ext. backup battery charger enable pin. This pin enables the main battery / DC source power to charge the backup battery. This pin toggled via the application processor. By grounding this pin the DC source continuously charges the backup battery |
| 30 | GPIO2 | I/O | D | General Purpose I/O |
| 31 | V _{IN} Buck3 | I | PWR | Battery input power to Buck3 |
| 32 | SW3 | O | PWR | Buck3 switcher output |
| 33 | PGND3 | G | G | Buck3 NMOS Power Ground |

| Pin # | Name | I/O | Type | Description |
|-------|-----------------------------------|-----|------|--|
| 34 | BGND1,2,3 查询"LP3972SQ-A514"供应商 | G | G | Bucks 1, 2 and 3 analog Ground |
| 35 | SYNC | I | D | Frequency Synchronization: Connection to an external clock signal PLL to synchronize the PMIC internal oscillator. |
| 36 | SYS_EN | I | D | Input Digital enable pin for the high voltage power domain supplies. Output from the Monahans processor. |
| 37 | PWR_EN | I | D | Digital enable pin for the Low Voltage domain supplies. Output signal from the Monahans processor |
| 38 | PGND1 | G | G | Buck1 NMOS Power Ground |
| 39 | SW1 | O | PWR | Buck1 Switcher output |
| 40 | VIN Buck1 | I | PWR | Battery input power to Buck1 |

A: Analog Pin D: Digital Pin G: Ground Pin P: Power Pin I: Input Pin I/O: Input/Output Pin O: Output Pin

Note: In this document active low logic items are prefixed with a lowercase "n"

Absolute Maximum Ratings (Note 1)

查询"LP3972SQ-A514"供应商

If Military/Aerospace specified devices are required, please contact the National Semiconductor Sales Office/Distributors for availability and specifications.

| | |
|--|-----------------|
| All Inputs | -0.3V to +6.5V |
| GND to GND SLUG | ±0.3V |
| Junction Temperature (T_{J-MAX}) | 150°C |
| Storage Temperature | -65°C to +150°C |
| Power Dissipation ($T_A = 70^\circ\text{C}$) (Note 3) | 3.2W |
| Junction-to-Ambient Thermal Resistance θ_{JA} (Note 3) | 25°C/W |

| | |
|-------------------------------|-------|
| Maximum Lead Temp (Soldering) | 260°C |
| ESD Rating (Note 5) | |
| Human Body Model | 2 kV |
| Machine Model | 200V |

Operating Ratings

| | |
|--|----------------------|
| V_{IN} LDO 4,5 | 2.7V to 5.5V |
| V_{EN} | 1.74 to (V_{IN}) |
| Junction Temperature (T_J) | -40°C to +125°C |
| Operating Temperature (T_A) | -40°C to +85°C |
| Maximum Power Dissipation ($T_A = 70^\circ\text{C}$) (Notes 3, 4) | 2.2W |

General Electrical Characteristics

Typical values and limits appearing in normal type apply for $T_J = 25^\circ\text{C}$. Limits appearing in **boldface** type apply over the entire junction temperature range for operation, -40°C to +125°C. (Notes 2, 6)

| Symbol | Parameter | Conditions | Min | Typ | Max | Units |
|--|------------------------------|-------------|-------------|-----|------------|-------|
| V_{IN} , VDDA, V_{IN} Buck1, 2 and 3 | Battery Voltage | | 2.7 | 3.6 | 5.5 | V |
| V_{IN} LDO4, V_{IN} LDO5 | Power Supply for LDO 4 and 5 | | 1.74 | 3.6 | 5.5 | V |
| T_{SD} | Thermal Shutdown (Note 14) | Temperature | | 160 | | °C |
| | | Hysteresis | | 20 | | |

**No input supply should be higher then VDDA

Supply Specifications (Notes 2, 5)

| Supply | V_{OUT} (Volts) | | I_{MAX} |
|--------------------------|-------------------|--------------------|--|
| | Range (V) | Resolution (mV) | Maximum Current |
| | | | Current (mA) |
| LDO_RTC | 2.8V | N/A | 30 mA dc source 10 mA backup source |
| LDO1 (V_{CC-MVT}) | 1.7 to 2.0 | 25 | 300 |
| LDO2 | 1.8 to 3.3 | 100 | 150 |
| LDO3 | 1.8 to 3.3 | 100 | 150 |
| LDO4 | 1.0 to 3.3 | 50-600 | 150 |
| LDO5 ($V_{CC-SRAM}$) | 0.850 to 1.5 | 25 | 400 |
| BUCK 1 ($V_{CC-APPS}$) | 0.725 to 1.5 | 25 | 1600 |
| BUCK 2 | 0.8 to 3.3 | 50-600 | 1600 |
| BUCK 3 | 0.8 to 3.3 | 50-600 | 1600 |

Default Voltage Option (Notes 2, 5)

| Version | LP3972SQ-A514 | | LP3972SQ-A413 | |
|---------|---------------|------|---------------|------|
| | Version A | | Version A | |
| Enable | — | | — | |
| LDO_RTC | — | 2.8 | — | 2.8 |
| LDO1 | SYS_EN | 1.8 | SYS_EN | 1.8 |
| LDO2 | SYS_EN | 1.8D | SYS_EN | 1.8D |
| LDO3 | SYS_EN | 3D | SYS_EN | 3D |
| LDO4 | SYS_EN | 3D | SYS_EN | 2.8D |
| LDO5 | PWR_EN | 1.4 | PWR_EN | 1.4 |
| BUCK1 | PWR_EN | 1.4 | PWR_EN | 1.4 |
| BUCK2 | SYS_EN | 3.3 | SYS_EN | 3 |
| BUCK3 | SYS_EN | 1.8 | SYS_EN | 1.8 |
| | | | | |
| Version | LP3972SQ-E514 | | LP3972SQ-I514 | |
| | Version E | | Version I | |
| Enable | — | | — | |
| LDO_RTC | — | 2.8 | — | 2.8 |
| LDO1 | SYS_EN | 1.8 | SYS_EN | 1.8 |
| LDO2 | SYS_EN | 1.8E | SYS_EN | 1.8E |
| LDO3 | SYS_EN | 3D | SYS_EN | 3E |
| LDO4 | SYS_EN | 3D | SYS_EN | 3E |
| LDO5 | PWR_EN | 1.4 | PWR_EN | 1.4 |
| BUCK1 | PWR_EN | 1.4 | PWR_EN | 1.4 |
| BUCK2 | SYS_EN | 3.3 | SYS_EN | 3.3 |
| BUCK3 | SYS_EN | 1.8 | SYS_EN | 1.8 |

Note : E = Regulator is ENABLED during startup

D = Regulator is DISABLED during startup

LDO RTC

查询"LP3972SQ-A514"供应商

Unless otherwise noted, $V_{IN} = 8.5V$, $C_{IN} = 1.0 \mu F$, $C_{OUT} = 0.47 \mu F$, $C_{OUT} (V_{RTC}) = 1.0 \mu F$ ceramic. Typical values and limits appearing in normal type apply for $T_J = 25^\circ C$. Limits appearing in **boldface** type apply over the entire junction temperature range for operation, $-40^\circ C$ to $+125^\circ C$. (Notes 2, 6, 7) and (Note 10)

| Symbol | Parameter | Conditions | Min | Typ | Max | Units |
|-----------------------|--|---|--------------|-----|--------------|------------|
| V_{OUT} Accuracy | Output Voltage Accuracy | V_{IN} Connected, Load Current = 1 mA | 2.632 | 2.8 | 2.968 | V |
| ΔV_{OUT} | Line Regulation | $V_{IN} = (V_{OUT} \text{ nom} + 1.0V)$ to 5.5V (Note 11) Load Current = 1 mA | | | 0.15 | %/V |
| | Load Regulation | From Main Battery Load Current = 1 mA to 30 mA | | | 0.05 | %mA |
| | | From Backup Battery $V_{IN} = 3.0V$ Load Current = 1 mA to 10 mA | | | 0.5 | |
| I_{SC} | Short Circuit Current Limit | From Main Battery $V_{IN} = V_{OUT} + 0.3V$ to 5.5V | | 100 | | mA |
| | | From Backup Battery | | 30 | | |
| $V_{IN} - V_{OUT}$ | Dropout Voltage | Load Current = 10 mA | | | 375 | mV |
| I_{Q_Max} | Maximum Quiescent Current | $I_{OUT} = 0$ mA | | 30 | | μA |
| TP1 | RTC LDO Input Switched from Main Battery to Backup Battery | V_{IN} Falling | | 2.9 | | V |
| TP2 | RTC LDO Input Switched from Backup Battery to Main Battery | V_{IN} Rising | | 3.0 | | V |
| C_O | Output Capacitor | Capacitance for Stability | 0.7 | 1.0 | | μF |
| | | ESR | 5 | | 500 | m Ω |

LDO 1 to 5

Unless otherwise noted, $V_{IN} = 3.6V$, $C_{IN} = 1.0\mu F$, $C_{OUT} = 0.47\mu F$, $C_{OUT}(V_{RTC}) = 1.0\mu F$ ceramic. Typical values and limits appearing in normal type apply for $T_J = 25^\circ C$. Limits appearing in **boldface** type apply over the entire junction temperature range for operation, $-40^\circ C$ to $+125^\circ C$. (Notes 2, 6, 7, 10, 11, 15) and (Note 16).

| Symbol | Parameter | Conditions | Min | Typ | Max | Units |
|--------------------|--|--|-------------|----------|--------------|------------|
| V_{OUT} Accuracy | Output Voltage Accuracy (Default V_{OUT}) | Load Current = 1 mA | -3 | | 3 | % |
| ΔV_{OUT} | Line Regulation | $V_{IN} = 3.1V$ to $5.0V$, (Note 11) Load Current = 1 mA | | | 0.15 | %/V |
| | Load Regulation | $V_{IN} = 3.6V$, Load Current = 1 mA to I_{MAX} | | | 0.011 | %/mA |
| I_{SC} | Short Circuit Current Limit | LDO1-4, $V_{OUT} = 0V$ | | 400 | | mA |
| | | LDO5, $V_{OUT} = 0V$ | | 500 | | |
| $V_{IN} - V_{OUT}$ | Dropout Voltage | Load Current = 50 mA (Note 7) | | | 150 | mV |
| PSRR | Power Supply Ripple Rejection | $f = 10$ kHz, Load Current = I_{MAX} | | 45 | | dB |
| I_Q | Quiescent Current "On" | $I_{OUT} = 0$ mA | | 40 | | μA |
| | Quiescent Current "On" | $I_{OUT} = I_{MAX}$ | | 60 | | |
| | Quiescent Current "Off" | EN is de-asserted | | 0.03 | | |
| T_{ON} | Turn On Time | Start up from Shut-down | | 300 | | μsec |
| C_{OUT} | Output Capacitor | Capacitance for Stability $0^\circ C \leq T_J \leq 125^\circ C$ | 0.33 | 0.47 | | μF |
| | | $-40^\circ C \leq T_J \leq 125^\circ C$ | 0.68 | 1.0 | | |
| | | ESR | | 5 | | 500 |

LDO Dropout Voltage vs. Load Current Collect Data For All LDO's

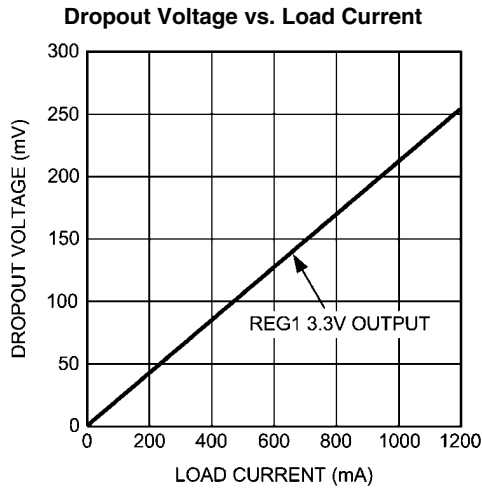

20207629

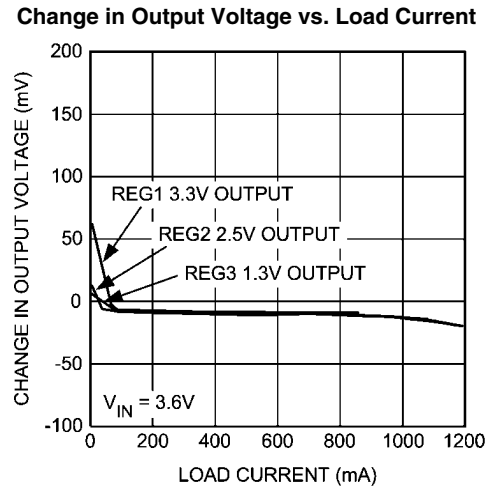

20207630

[查询"LP3972SQ-A8"供应商](#)
LDO1 Line Regulation
 $V_{OUT} = 1.8$ volts $V_{IN} = 3$ volts Load = 100 mA

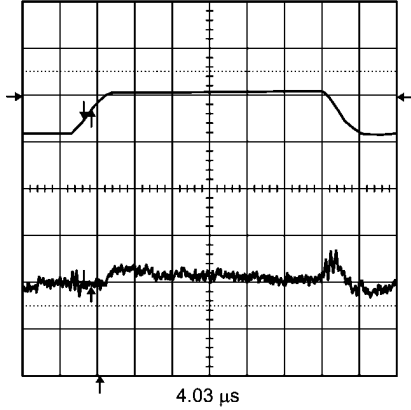

20207631

LDO1 Load Transient
 $V_{IN} = 4.1$ volts $V_{OUT} = 1.8$ volts no-load-100 mA

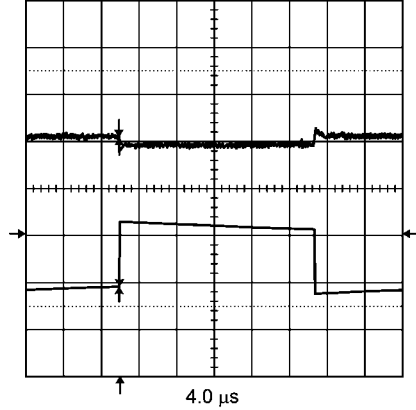

20207632

Enable Start-up time (LDO1)
 LDO1 channel 2 LDO4 Channel 1 Sys_enable from 0 volts
 Load = 100mA

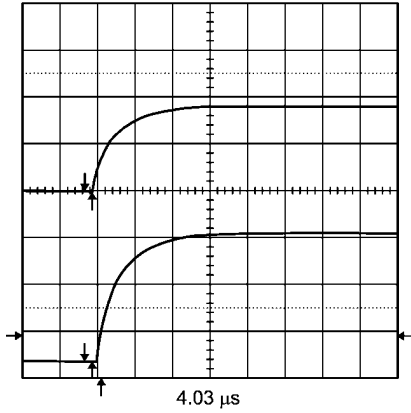

20207633

Buck Converters SW1, SW2, SW3

Unless otherwise noted, $V_{IN} = 3.6V$, $C_{IN} = 10\mu F$, $C_{OUT} = 10\mu F$, $L_{OUT} = 2.2\mu H$ ceramic. Typical values and limits appearing in normal type apply for $T_J = 25^\circ C$. Limits appearing in **boldface** type apply over the entire junction temperature range for operation, $-40^\circ C$ to $+125^\circ C$. (Notes 2, 6, 12) and (Note 13).

| Symbol | Parameter | Conditions | Min | Typ | Max | Units |
|---------------|-------------------------------|---------------------------------------|------|-----|------|-----------|
| V_{OUT} | Output Voltage Accuracy | Default V_{OUT} | -3 | | +3 | % |
| Eff | Efficiency | Load Current = 500 mA | | 95 | | % |
| I_{SHDN} | Shutdown Supply Current | EN is de-asserted | | 0.1 | | μA |
| | Sync Mode Clock Frequency | Synchronized from 13 MHz System Clock | 10.4 | 13 | 15.6 | MHz |
| f_{OSC} | Internal Oscillator Frequency | | | 2.0 | | MHz |
| I_{PEAK} | Peak Switching Current Limit | | | 2.1 | 2.4 | A |
| I_Q | Quiescent Current "On" | No Load PFM Mode | | 21 | | μA |
| | | No Load PWM Mode | | 200 | | |
| $R_{DSON(P)}$ | Pin-Pin Resistance PFET | | | 240 | | $m\Omega$ |
| $R_{DSON(N)}$ | Pin-Pin Resistance NFET | | | 200 | | $m\Omega$ |
| T_{ON} | Turn On Time | Start up from Shut-down | | 500 | | μsec |
| C_{IN} | Input Capacitor | Capacitance for Stability | 8 | | | μF |
| C_O | Output Capacitor | Capacitance for Stability | 8 | | | μF |

Buck 1 Output Efficiency vs. Load Current Varied from 1mA to 1.5 Amps

$V_{IN} = 3, 3.5$ volts $V_{OUT} = 1.4$ volts Forced PWM

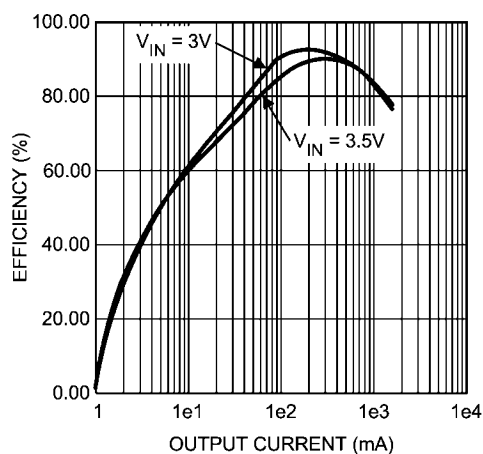

20207634

$V_{IN} = 4.0-4.5$ volts $V_{OUT} = 1.4$ volts Forced PWM

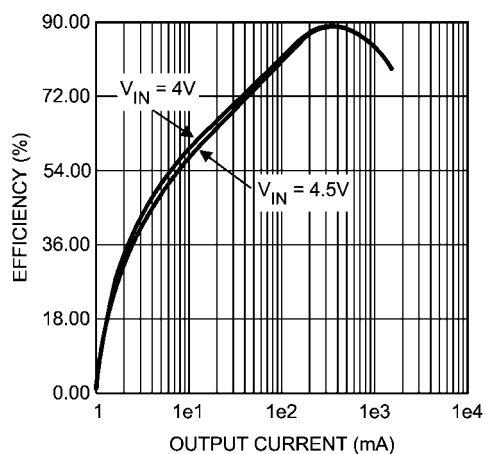

20207635

$V_{IN} = 3, 3.5 \text{ volts } V_{OUT} = 1.4 \text{ volts Forced PWM}$
 查询"LP3972SQ-A514"供应商

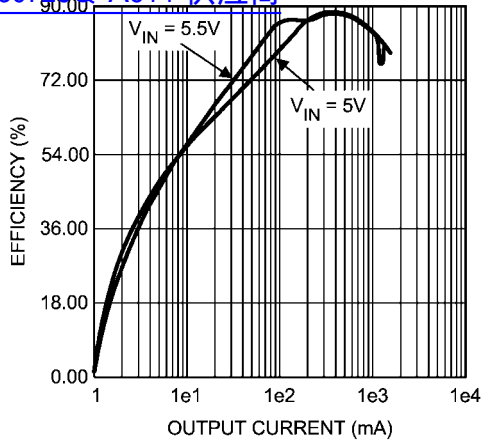

20207636

Line Transient Response
 $V_{IN} = 3 - 3.6 \text{ V}, V_{OUT} = 1.2 \text{ V}, 250 \text{ mA load}$

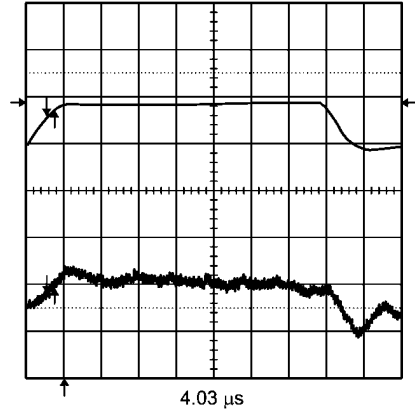

20207637

Load Transient
 $3.6 V_{IN}, 3.3 V_{OUT}, 0 - 100 \text{ mA load}$

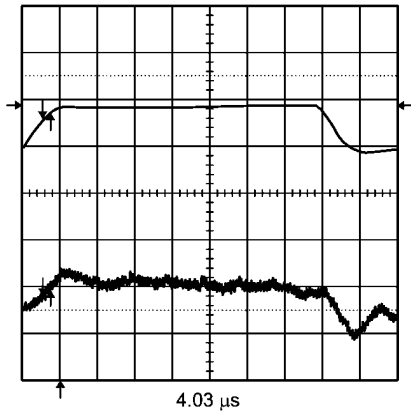

20207638

Mode Change
 Load transients 20 mA to 560 mA
 $V_{OUT} = 1.4 \text{ volts [PFM to PWM] } V_{IN} = 4.1 \text{ volts}$

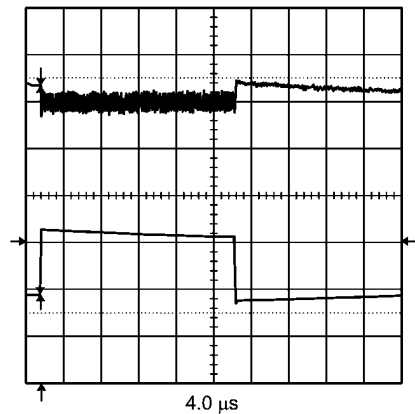

20207639

Startup
 Startup into PWM Mode 980 mA [channel 2]
 $V_{OUT} = 1.4 \text{ volts } V_{IN} = 4.1 \text{ volts}$

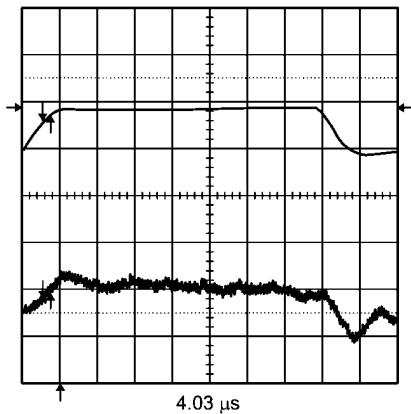

20207638

Back-Up Charger Electrical Characteristics

Unless otherwise noted, $V_{IN} = V_{BATT} = 5.0V$. Typical values and limits appearing in normal type apply for $T_j = 25^\circ C$. Limits appearing in **boldface** type apply over the entire junction temperature range for operation, $-40^\circ C$ to $+125^\circ C$. (Notes 2, 6) and (Note 8).

| Symbol | Parameter | Conditions | Min | Typ | Max | Units |
|-----------|--|---|-------------|-----|------------|------------|
| V_{IN} | Operational Voltage Range | Voltage at V_{IN} | 3.3 | | 5.5 | V |
| I_{OUT} | Backup Battery Charging Current | $V_{IN} = 3.6V$, Backup_Bat = 2.5V, Backup Battery Charger Enabled (Note 8) | | 190 | | μA |
| V_{OUT} | Charger Termination Voltage | $V_{IN} = 5.0V$ Backup Battery Charger Enabled. Programmable | 2.91 | 3.1 | | V |
| | Backup Battery Charger Short Circuit Current | Backup_Bat = 0V, Backup Battery Charger Enabled | | 9 | | mA |
| PSRR | Power Supply Ripple Rejection Ratio | $I_{OUT} \leq 50 \mu A$, $V_{OUT} = 3.15V$ $V_{OUT} + 0.4 \leq V_{BATT} = V_{IN} \leq 5.0V$ $f < 10 \text{ kHz}$ | | 15 | | dB |
| I_Q | Quiescent Current | $I_{OUT} < 50 \mu A$ | | 25 | | μA |
| C_{OUT} | Output Capacitance | $0 \mu A \leq I_{OUT} \leq 100 \mu A$ | | 0.1 | | μF |
| | Output Capacitor ESR | | 5 | | 500 | m Ω |

LP3972 Battery Switch Operation

The LP3972 has provisions for two battery connections, the main battery Vbat and Backup Battery

The function of the battery switch is to connect power to the RTC LDO from the appropriate battery, depending on conditions described below:

- If only the backup battery is applied, the switch will automatically connect the RTC LDO power to this battery.
- If only the main battery is applied, the switch will automatically connect the RTC LDO power to this battery
- If both batteries are applied, and the main battery is sufficiently charged ($V_{bat} > 3.1V$), the switch will automatically connect the RTC LDO power to the main battery.
- As the main battery is discharged a separate circuit called nBATT_FLT will warn the system. Then if no action is taken to restore the charge on the main battery, and discharging is

continued the battery switch will disconnect the input of the RTC_LDO from the main battery and connect to the backup battery.

- The main battery voltage at which the RTC LDO is switched over from main to backup battery is 2.8V typically.
- There is a hysteric voltage in this switch operation so; the RTC LDO will not be reconnected to main battery until main battery voltage is greater than 3.1V typically.
- The system designer may wish to disable the battery switch when only a main battery is used. This is accomplished by setting the "no back up battery bit" in the control register 8h'0B bit 7 NBUB. With this bit set to "1", the above described switching will not occur, that is the RTC LDO will remain connected to the main battery even as it is discharged below the 2.9V threshold. The Backup battery input should also be connected to main battery.

Logic Inputs and Outputs DC Operating Conditions (Note 2)

Logic Inputs: Sys_EN, PWR_EN, SYNC, nRSTI, PWR_ON, nTEST_JIG, SPARE and GPI's

| Symbol | Parameter | Conditions | Min | Max | Units |
|-------------------|--------------------------|------------|---------------------------|-----|-------|
| V _{IL} | Low Level Input Voltage | | | 0.5 | V |
| V _{IH} | High Level Input Voltage | | V _{RTC} -0.5V | | V |
| I _{LEAK} | Input Leakage Current | | -1 | +1 | μA |

Logic Outputs (nRSTO, EXT_WAKEUP and GPO's)

| Symbol | Parameter | Conditions | Min | Max | Units |
|-------------------|------------------------|--------------------------------------|---------------------------|-----|-------|
| V _{OL} | Output Low Level | Load = +0.2 mA = I _{OL} Max | | 0.5 | V |
| V _{OH} | Output High Level | Load = -0.1 mA = I _{OL} Max | V _{RTC} -0.5V | | V |
| I _{LEAK} | Output Leakage Current | V _{ON} = V _{IN} | | +5 | μA |

Logic Output (nBATT_FLT)

| Symbol | Parameter | Conditions | Min | Typ | Max | Units |
|-------------------|-----------------------------|---|---------------------------|-----|-----|-------|
| | nBATT_FLT Threshold Voltage | Programmable via Serial Interface Default = 2.8V | 2.4 | 2.8 | 3.4 | V |
| V _{OL} | Output Low Level | Load = +0.4 mA = I _{OL} Max | | | 0.5 | V |
| V _{OH} | Output High Level | Load = -0.2 mA = I _{OH} Max | V _{RTC} -0.5V | | | V |
| I _{LEAK} | Input Leakage Current | | | | +5 | μA |

I²C Compatible Serial Interface Electrical Specifications (SDA and SCL)

Unless otherwise noted, $V_{IN} = 5.5V$. Typical values and limits appearing in normal type apply for $T_J = 25^\circ C$. Limits appearing in **boldface** type apply over the entire junction temperature range for operation, $-40^\circ C$ to $+125^\circ C$. (Notes 2, 6) and (Note 9)

| Symbol | Parameter | Conditions | Min | Typ | Max | Units |
|---------------|--|---------------------------|---------------|-----|---------------|---------|
| V_{IL} | Low Level Input Voltage | (Note 14) | -0.5 | | $0.3 V_{RTC}$ | V |
| V_{IH} | High Level Input Voltage | (Note 14) | $0.7 V_{RTC}$ | | V_{RTC} | |
| V_{OL} | Low Level Output Voltage | (Note 14) | 0 | | $0.2 V_{TRC}$ | |
| I_{OL} | Low Level Output Current | $V_{OL} = 0.4V$ (Note 14) | 3.0 | | | mA |
| F_{CLK} | Clock Frequency | (Note 14) | | | 400 | kHz |
| t_{BF} | Bus-Free Time Between Start and Stop | (Note 14) | 1.3 | | | μs |
| t_{HOLD} | Hold Time Repeated Start Condition | (Note 14) | 0.6 | | | μs |
| t_{CLKLP} | CLK Low Period | (Note 14) | 1.3 | | | μs |
| t_{CLKHP} | CLK High Period | (Note 14) | 0.6 | | | μs |
| t_{SU} | Set Up Time Repeated Start Condition | (Note 14) | 0.6 | | | μs |
| $t_{DATAHLD}$ | Data Hold Time | (Note 14) | 0 | | | μs |
| t_{CLKSU} | Data Set Up Time | (Note 14) | 100 | | | ns |
| T_{SU} | Set Up Time for Start Condition | (Note 14) | 0.6 | | | μs |
| T_{TRANS} | Maximum Pulse Width of Spikes that Must be Suppressed by the Input Filter of Both DATA & CLK Signals | (Note 14) | | 50 | | ns |

Note 1: Absolute Maximum Ratings are limits beyond which damage to the device may occur. Operating Ratings are conditions under which operation of the device is guaranteed. Operating Ratings do not imply guaranteed performance limits. For guaranteed performance limits and associated test conditions, see the Electrical Characteristics tables.

Note 2: All voltages are with respect to the potential at the GND pin.

Note 3: In applications where high power dissipation and/or poor package thermal resistance is present, the maximum ambient temperature may have to be derated. Maximum ambient temperature (TA-MAX) is dependent on the maximum operating junction temperature ($T_{J-MAX-OP} = 125^\circ C$), the maximum power dissipation of the device in the application (PD-MAX), and the junction-to ambient thermal resistance of the part/package in the application (θ_{JA}), as given by the following equation: $TA-MAX = T_{J-MAX-OP} - (\theta_{JA} \times PD-MAX)$.

Note 4: Junction-to-ambient thermal resistance (θ_{JA}) is taken from a thermal modeling result, performed under the conditions and guidelines set forth in the JEDEC standard JESD51-7. The test board is a 4-layer FR-4 board measuring 102 mm x 76 mm x 1.6 mm with a 2x1 array of thermal vias. The ground plane on the board is 50 mm x 50 mm. Thickness of copper layers are 36 μm /1.8 μm /18 μm /36 μm (1.5 oz/1 oz/1 oz/1.5 oz). Ambient temperature in simulation is 22° C, still air. Power dissipation is 1W. Junction-to-ambient thermal resistance is highly application and board-layout dependent. In applications where high maximum power dissipation exists, special care must be paid to thermal dissipation issues in board design. The value of θ_{JA} of this product can vary significantly, depending on PCB material, layout, and environmental conditions. In applications where high maximum power dissipation exists (high V_{IN} , high I_{OUT}), special care must be paid to thermal dissipation issues. For more information on these topics, please refer to *Application Note 1187: Leadless Leadframe Package (LLP) and the Power Efficiency and Power Dissipation* section of this datasheet.

Note 5: The Human body model is a 100 pF capacitor discharged through a 1.5 k resistor into each pin. (MIL-STD-883 3015.7) The machine model is a 200 pF capacitor discharged directly into each pin. (EAIJ)

Note 6: All limits guaranteed at room temperature (standard typeface) and at temperature extremes (bold typeface). All room temperature limits are production tested, guaranteed through statistical analysis or guaranteed by design. All limits at temperature extremes are guaranteed via correlation using standard Statistical Quality Control (SQC) methods. All limits are used to calculate Average Outgoing Quality Level (AOQL).

Note 7: Dropout voltage is the input-to-output voltage difference at which the output voltage is 100 mV below its nominal value.

Note 8: Back-up battery charge current is programmable via the I²C compatible interface. Refer to the Application Section for more information.

Note 9: The I²C signals behave like open-drain outputs and require an external pull-up resistor on the system module in the 2 k Ω to 20 k Ω range.

Note 10: LDO_RTC voltage can track LDO3 voltage. LP3972 has a tracking function (nIO_TRACK). When enabled, LDO_RTC voltage will track LDO3 voltage within 200mV down to 2.8V when LDO3 is enabled

Note 11: V_{IN} minimum for line regulation values is 2.7V for LDOs 1–3 and 1.8V for LDOs 4 and 5. Condition does not apply to input voltages below the minimum input operating voltage.

Note 12: The input voltage range recommended for ideal applications performance for the specified output voltages is given below:

$$V_{IN} = 2.7V \text{ to } 5.5V \text{ for } 0.80V < V_{OUT} < 1.8V$$

$$V_{IN} = (V_{OUT} + 1V) \text{ to } 5.5V \text{ for } 1.8V \leq V_{OUT} \leq 3.3V$$

Note 13: Test condition: for V_{OUT} less than 2.7V, $V_{IN} = 3.6V$; for V_{OUT} greater than or equal to 2.7V, $V_{IN} = V_{OUT} + 1V$.

Note 14: This electrical specification is guaranteed by design.

Note 15: An increase in the load current results in a slight decrease in the output voltage and vice versa.

Note 16: Dropout voltage is the input-to-output voltage difference at which the output voltage is 100 mV below its nominal value. This specification does not apply for input voltages below 2.7V for LDOs 1–3 and 1.8V for LDOs 4 and 5.

Buck Converter Operation

查询"LP3972SQ-A514"供应商

DEVICE INFORMATION

The LP3972 includes three high efficiency step down DC-DC switching buck converters. Using a voltage mode architecture with synchronous rectification, the buck converters have the ability to deliver up to 1600 mA depending on the input voltage, output voltage, ambient temperature and the inductor chosen.

There are three modes of operation depending on the current required - PWM, PFM, and shutdown. The device operates in PWM mode at load currents of approximately 100 mA or higher, having voltage tolerance of $\pm 3\%$ with 95% efficiency or better. Lighter load currents cause the device to automatically switch into PFM for reduced current consumption. Shutdown mode turns off the device, offering the lowest current consumption ($I_{Q,SHUTDOWN} = 0.01 \mu\text{A typ}$).

Additional features include soft-start, under voltage protection, current overload protection, and thermal shutdown protection.

The part uses an internal reference voltage of 0.5V. It is recommended to keep the part in shutdown until the input voltage is 2.7V or higher.

CIRCUIT OPERATION

The buck converter operates as follows. During the first portion of each switching cycle, the control block turns on the internal PFET switch. This allows current to flow from the input through the inductor to the output filter capacitor and load. The inductor limits the current to a ramp with a slope of $(V_{IN} - V_{OUT})/L$, by storing energy in a magnetic field.

During the second portion of each cycle, the controller turns the PFET switch off, blocking current flow from the input, and then turns the NFET synchronous rectifier on. The inductor draws current from ground through the NFET to the output filter capacitor and load, which ramps the inductor current down with a slope of $-V_{OUT}/L$.

The output filter stores charge when the inductor current is high, and releases it when inductor current is low, smoothing the voltage across the load.

The output voltage is regulated by modulating the PFET switch on time to control the average current sent to the load. The effect is identical to sending a duty-cycle modulated rectangular wave formed by the switch and synchronous rectifier at the SW pin to a low-pass filter formed by the inductor and output filter capacitor. The output voltage is equal to the average voltage at the SW pin.

PWM OPERATION

During PWM operation the converter operates as a voltage mode controller with input voltage feed forward. This allows the converter to achieve good load and line regulation. The DC gain of the power stage is proportional to the input voltage. To eliminate this dependence, feed forward inversely proportional to the input voltage is introduced.

While in PWM (Pulse Width Modulation) mode, the output voltage is regulated by switching at a constant frequency and then modulating the energy per cycle to control power to the load. At the beginning of each clock cycle the PFET switch is turned on and the inductor current ramps up until the comparator trips and the control logic turns off the switch. The current limit comparator can also turn off the switch in case the current limit of the PFET is exceeded. Then the NFET switch is turned on and the inductor current ramps down. The

next cycle is initiated by the clock turning off the NFET and turning on the PFET.

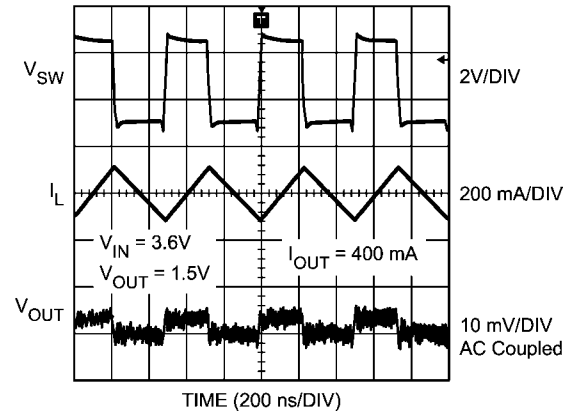

20207611

FIGURE 1. Typical PWM Operation

Internal Synchronous Rectification

While in PWM mode, the converters uses an internal NFET as a synchronous rectifier to reduce rectifier forward voltage drop and associated power loss. Synchronous rectification provides a significant improvement in efficiency whenever the output voltage is relatively low compared to the voltage drop across an ordinary rectifier diode.

Current Limiting

A current limit feature allows the converters to protect itself and external components during overload conditions. PWM mode implements current limiting using an internal comparator that trips at 2.0 A (typ). If the output is shorted to ground the device enters a timed current limit mode where the NFET is turned on for a longer duration until the inductor current falls below a low threshold, ensuring inductor current has more time to decay, thereby preventing runaway.

PFM OPERATION

At very light loads, the converter enters PFM mode and operates with reduced switching frequency and supply current to maintain high efficiency.

The part will automatically transition into PFM mode when either of two conditions occurs for a duration of 32 or more clock cycles:

- A:** The inductor current becomes discontinuous.
- B:** The peak PMOS switch current drops below the I_{MODE} level, (Typically $I_{MODE} < 30 \text{ mA} + V_{IN}/42\Omega$).

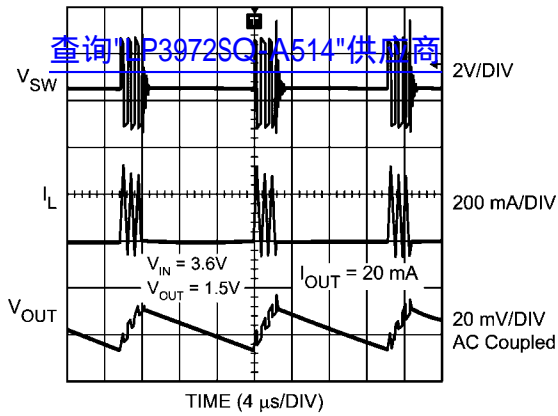

20207612

FIGURE 2. Typical PFM Operation

During PFM operation, the converter positions the output voltage slightly higher than the nominal output voltage during PWM operation, allowing additional headroom for voltage drop during a load transient from light to heavy load. The PFM comparators sense the output voltage via the feedback pin and control the switching of the output FETs such that the output voltage ramps between <0.6% and <1.7% above the nominal PWM output voltage. If the output voltage is below

the “high” PFM comparator threshold, the PMOS power switch is turned on. It remains on until the output voltage reaches the ‘high’ PFM threshold or the peak current exceeds the IPFM level set for PFM mode. The typical peak current in PFM mode is: $IPFM = 112 \text{ mA} + V_{IN}/27\Omega$. Once the PMOS power switch is turned off, the NMOS power switch is turned on until the inductor current ramps to zero. When the NMOS zero-current condition is detected, the NMOS power switch is turned off. If the output voltage is below the ‘high’ PFM comparator threshold (see Figure 3), the PMOS switch is again turned on and the cycle is repeated until the output reaches the desired level. Once the output reaches the ‘high’ PFM threshold, the NMOS switch is turned on briefly to ramp the inductor current to zero and then both output switches are turned off and the part enters an extremely low power mode. Quiescent supply current during this ‘sleep’ mode is 21 μA (typ), which allows the part to achieve high efficiencies under extremely light load conditions. When the output drops below the ‘low’ PFM threshold, the cycle repeats to restore the output voltage (average voltage in PFM mode) to <1.15% above the nominal PWM output voltage. If the load current should increase during PFM mode (see Figure 3) causing the output voltage to fall below the ‘low2’ PFM threshold, the part will automatically transition into fixed-frequency PWM mode. Typically when $V_{IN} = 3.6\text{V}$ the part transitions from PWM to PFM mode at 100 mA output current .

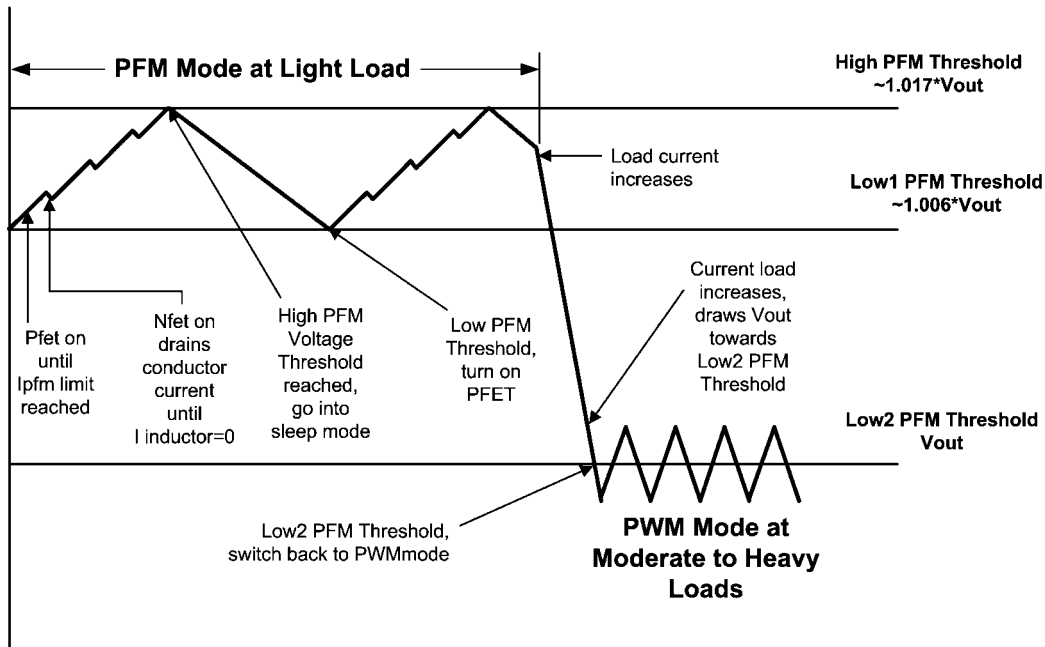

20207613

FIGURE 3. Operation in PFM Mode and Transfer to PWM Mode

SHUTDOWN MODE

During shutdown the PFET switch, reference, control and bias circuitry of the converters are turned off. The NFET switch will be open in shutdown to discharge the output. When the converter is enabled, EN, soft start is activated. It is recommended to disable the converter during the system power up and undervoltage conditions when the supply is less than 2.7V.

SOFT START

The buck converter has a soft-start circuit that limits in-rush current during start-up. During start-up the switch current limit is increased in steps. Soft start is activated only if EN goes from logic low to logic high after V_{IN} reaches 2.7V. Soft start is implemented by increasing switch current limit in steps of 213 mA, 425 mA, 850 mA and 1700 mA (typ. Switch current limit). The start-up time thereby depends on the output capacitor and load current demanded at start-up. Typical start-

up times with 10 μF output capacitor and 1000 mA load current is 390 μs and with 1 mA load current its 295 μs .

查询 LP3972SG A514 供应商

LDO - LOW DROP OUT OPERATION

The LP3672 can operate at 100% duty cycle (no switching; PMOS switch completely on) for low drop out support of the output voltage. In this way the output voltage will be controlled down to the lowest possible input voltage. When the device operates near 100% duty cycle, output voltage ripple is approximately 25 mV. The minimum input voltage needed to support the output voltage is

$$V_{\text{IN, MIN}} = I_{\text{LOAD}} * (R_{\text{DSON, PFET}} + R_{\text{INDUCTOR}}) + V_{\text{OUT}}$$

- I_{LOAD} Load Current
- $R_{\text{DSON, PFET}}$ Drain to source resistance of PFET switch in the triode region
- R_{INDUCTOR} Inductor resistance

SPREAD SPECTRUM FEATURE

Periodic switching in the buck regulator is inherently a noisier function block compared to an LDO. It can be challenging in some critical applications to comply with stringent regulatory standards or simply to minimize interference to sensitive circuits in space limited portable systems. The regulator's switching frequency and harmonics can cause "noise" in the signal spectrum. The magnitude of this noise is measured by its power spectral density. The power spectral density of the

switching frequency, F_C , is one parameter that system designers want to be as low as practical to reduce interference to the environment and subsystems within their products. The LP3972 has a user selectable function on chip, wherein a noise reduction technique known as "spread spectrum" can be employed to ease customer's design and production issues.

The principle behind spread spectrum is to modulate the switching frequency slightly and slowly, and spread the signal frequency over a broader bandwidth. Thus, its power spectral density becomes attenuated, and the associated interference electro-magnetic energy is reduced. The clock used to modulate the LP3972 buck regulator can be used as a spread spectrum clock via 2 I²C control register (System Control Register 1 (SCR1) 8h'80) bits bk_ssen, and slomod. With this feature enabled, the intense energy of the clock frequency can be spread across a small band of frequencies in the neighborhood of the center frequency. The results in a reduction of the peak energy!

The LP3972 spread spectrum clock uses a triangular modulation profile with equal rise and fall slopes. The modulation has the following characteristics:

- The center frequency: $F_C = 2 \text{ MHz}$, and
- The modulating frequency, $f_M = 6.8 \text{ kHz}$ or 12 kHz .
- Peak frequency deviation: $\Delta_f = \pm 100 \text{ kHz}$ (or $\pm 5\%$)
- Modulation index $\beta = \Delta_f / f_M = 14.7$ or 8.3

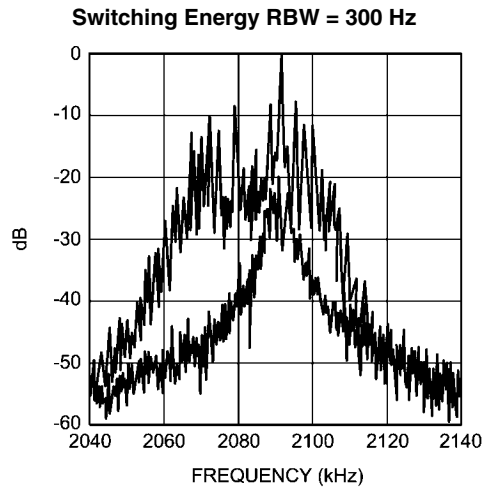

I²C Compatible Interface

[查询"LP3972SQ-A514"供应商](#)

I²C DATA VALIDITY

The data on SDA line must be stable during the HIGH period of the clock signal (SCL). In other words, state of the data line can only be changed when CLK is LOW.

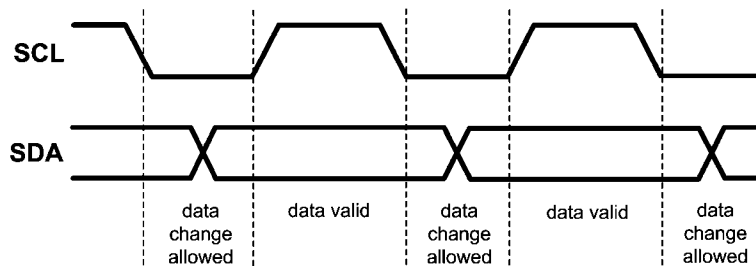

I²C START and STOP CONDITIONS

START and STOP bits classify the beginning and the end of the I²C session. START condition is defined as SDA signal transitioning from HIGH to LOW while SCL line is HIGH. STOP condition is defined as the SDA transitioning from LOW to HIGH while SCL is HIGH. The I²C master always generates

START and STOP bits. The I²C bus is considered to be busy after START condition and free after STOP condition. During data transmission, I²C master can generate repeated START conditions. First START and repeated START conditions are equivalent, function-wise.

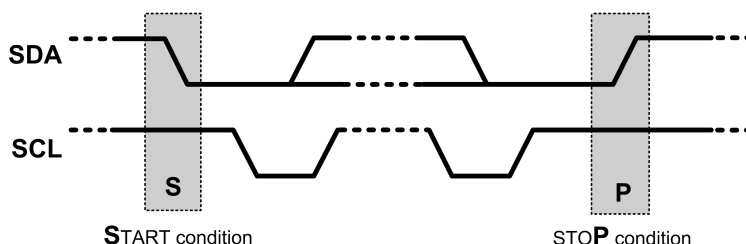

TRANSFERRING DATA

Every byte put on the SDA line must be eight bits long, with the most significant bit (MSB) being transferred first. The number of bytes that can be transmitted per transfer is unrestricted. Each byte of data has to be followed by an acknowledge bit. The acknowledge related clock pulse is generated by the master. The transmitter releases the SDA line (HIGH) during the acknowledge clock pulse. The receiver must pull down the SDA line during the 9th clock pulse, signifying an

acknowledge. A receiver which has been addressed must generate an acknowledge after each byte has been received. After the START condition, a chip address is sent by the I²C master. This address is seven bits long followed by an eighth bit which is a data direction bit (R/W). The LP3972 address is 34h. For the eighth bit, a "0" indicates a WRITE and a "1" indicates a READ. The second byte selects the register to which the data will be written. The third byte contains data to write to the selected register.

I²C CHIP ADDRESS - 7h'34

| MSB | | | | | | | |
|--------------|--------------|--------------|--------------|--------------|--------------|--------------|-------------|
| ADR6 Bit7 | ADR5 Bit6 | ADR4 Bit5 | ADR3 Bit4 | ADR2 Bit3 | ADR1 Bit2 | ADR0 Bit1 | R/W Bit0 |
| 0 | 1 | 1 | 0 | 1 | 0 | 0 | R/W |

Write Cycle

[查询"LP3972SQ-A514"供应商](#)

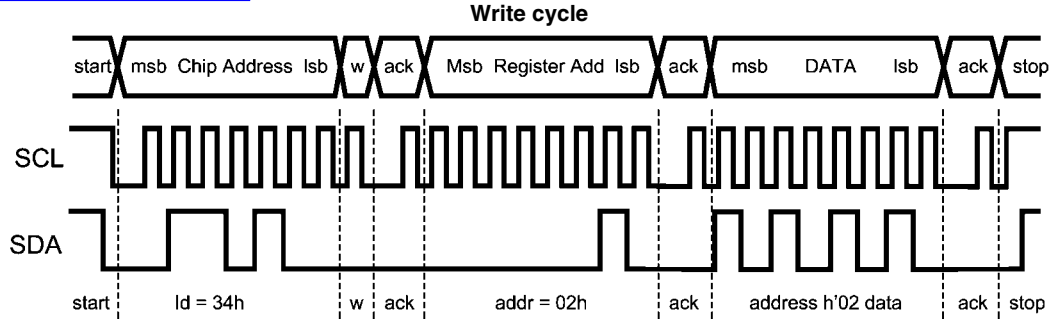

20207616

Read Cycle

When a READ function is to be accomplished, a WRITE function must precede the READ function as follows.

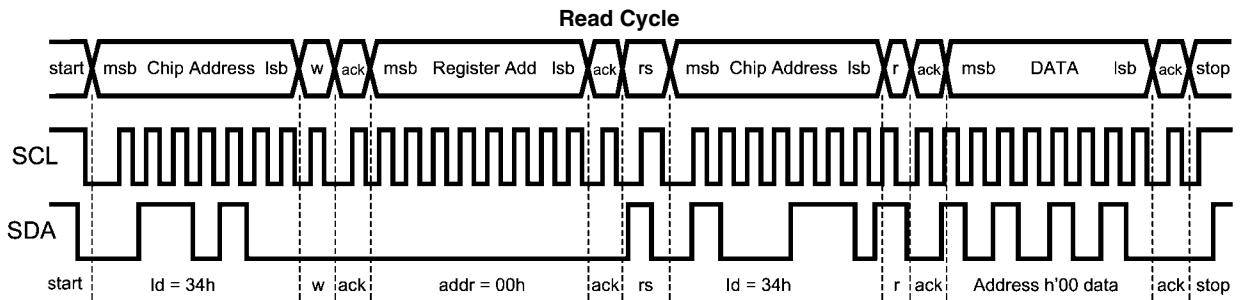

20207617

- w = write (SDA = "0")
- r = read (SDA = "1")
- ack = acknowledge (SDA pulled down by either master or slave)
- rs = repeated start
- id = 34h (Chip Address)

I²C DVM Timing for V_{CC-APPS} (Buck1)

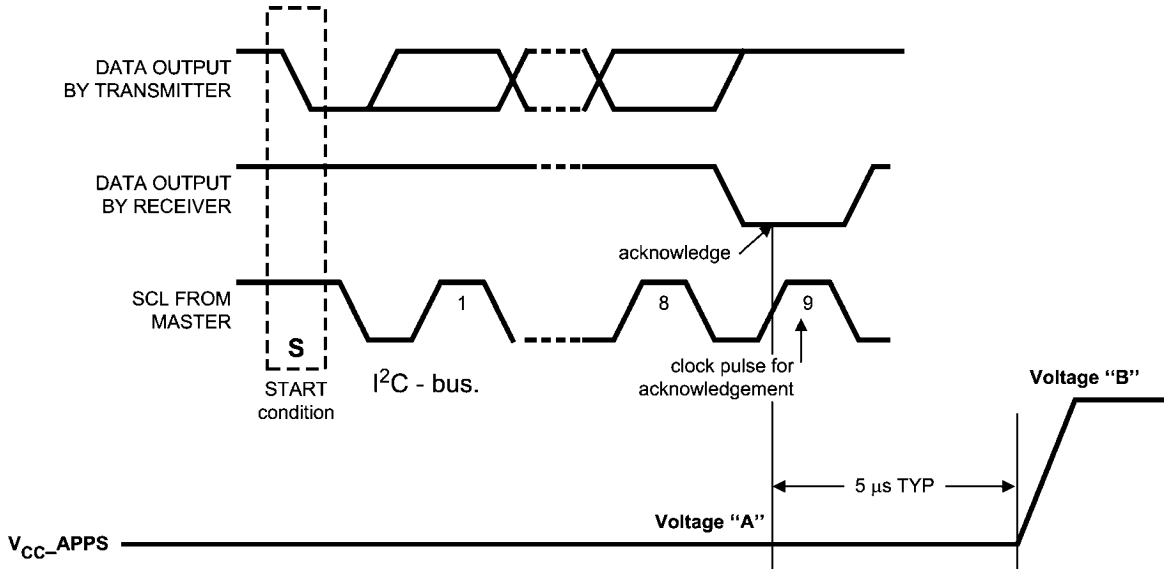

20207618

MULTI-BYTE I²C COMMAND SEQUENCE

To correctly implement the On-Chip Power Management I²C the LP3972's I²C serial interface shall support Random register Multi-byte command sequencing: During a multi-byte write the Master sends the Start command followed by the Device address, which is sent only once, followed by the 8 Bit register address, then 8-bits of data. The I²C slave must then accept the next random register address followed by 8 bits of data and continue this process until the master sends a valid stop condition.

A Typical Multi-byte random register transfer is outlined below:

- Device Address, Register A Address, Ach,
- Register A Data, Ach
- Register M Address, Ach,
- Register M Data, Ach
- Register X Address, Ach,
- Register X Data, Ach
- Register Z Address, Ach,
- Register Z Data, Ach, Stop

Note: the PMIC is not required to see the I²C device address for each transaction. A, M, X, and Z are Random numbers.

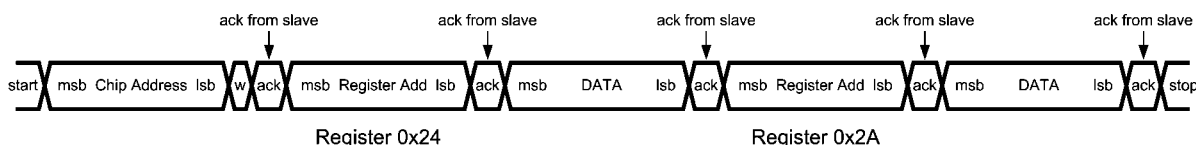

INCREMENTAL REGISTER I²C COMMAND SEQUENCE

The LP3972 supports address increment (burst mode). When you have defined register address n data bytes can be sent and register address is incremented after each data byte has

been sent. Address incrementation may be required for non XScale applications. User can define whether multi-byte (default) to random address or address incrementation will be used.



LP3972 CONTROL REGISTER

[查询"LP3972SQ-A514"供应商](#)

| Register Address | Register Name | Read/Write | Register Description |
|------------------|-------------------|------------|--|
| 8h'07 | SCR | R/W | System Control Register |
| 8h'10 | OVER1 | R/W | Output Voltage Enable Register 1 |
| 8h'11 | OVS1 | R | Output Voltage Status Register 1 |
| 8h'12 | OVER2 | R/W | Output Voltage Enable Register 2 |
| 8h'13 | OVS2 | R | Output Voltage Status Register 2 |
| 8h'20 | V _{CC} 1 | R/W | Voltage Change Control Register 1 |
| 8h'23 | ADTV1 | R/W | BUCK1 Target Voltage 1 Register |
| 8h'24 | ADTV2 | R/W | BUCK1 DVM Target Voltage 2 Register |
| 8h'25 | AVRC | R/W | V _{CC} _APPS Voltage Ramp Control |
| 8h'26 | CDTC1 | W | Dummy Register |
| 8h'27 | CDTC2 | W | Dummy Register |
| 8h'29 | SDTV1 | R/W | LDO5 Target Voltage 1 |
| 8h'2A | SDTV2 | R/W | LDO5 Target Voltage 2 |
| 8h'32 | MDTV1 | R/W | LDO1 Target Voltage 1 Register |
| 8h'33 | MDTV2 | R/W | LDO1 Voltage 2 Register |
| 8h'39 | L2VCR | R/W | LDO2 Voltage Control Registers |
| 8h'3A | L34VCR | R/W | LDO3 & LDO4 Voltage Control Registers |
| 8h'80 | SCR1 | R/W | System Control Register 1 |
| 8h'81 | SCR2 | R/W | System Control Register 2 |
| 8h'82 | OEN3 | R/W | Output Voltage Enable Register 3 |
| 8h'83 | OSR3 | R/W | Output Voltage Status Register 3 |
| 8h'84 | LOER4 | R/W | Output Voltage Enable Register 3 |
| 8h'85 | B2TV | R/W | V _{CC} _Buck2 Target Voltage |
| 8h'86 | B3TV | R/W | V _{CC} _Buck3 Target Voltage |
| 8h'87 | B32RC | R/W | Buck 32 Voltage Ramp Control |
| 8h'88 | ISRA | R | Interrupt Status Register A |
| 8h'89 | BCCR | R/W | Backup Battery Charger Control Register |
| 8h'8E | I1RR | R | Internal 1 Revision Register |
| 8h'8F | I2RR | R | Internal 2 Revision Register |

SERIAL INTERFACE REGISTER SELECTION CODES (Bold face voltages are default values)**System Control Status Register**

Register is an 8 bit register which specifies the control bits for the PMIC clocks. This register works in conjunction with the SYNC pin where an external clock PLL buffer operating at 13 MHz is synchronized with the oscillators of the buck converters.

System Control Register (SCR) 8h'07

| Bit | 7 | 6 | 5 | 4 | 3 | 2 | 1 | 0 |
|-------------|----------|---|---|---|---|---|---|---------|
| Designation | Reserved | | | | | | | CLK_SCL |
| Reset Value | 0 | 0 | 0 | 0 | 0 | 0 | 0 | 0 |

System Control Register (SCR) 8h'07 Definitions

| Bit | Access | Name | Description |
|-----|--------|---------|--|
| 7-1 | — | — | Reserved |
| 0 | R/W | CLK_SCL | External Clock Select 0 = Internal Oscillator clock for Buck Converters 1 = External 13 MHz Oscillator clock for Buck Converters |

OUTPUT VOLTAGE ENABLE REGISTER 1

This register enables or disables the low voltage supplies LDO1 and Buck1. See details below.

Output Voltage Enable Register 1 (OVER1) 8h'10

| Bit | 7 | 6 | 5 | 4 | 3 | 2 | 1 | 0 |
|-------------|----------|---|---|---|---|------|----------|------|
| Designation | Reserved | | | | | S_EN | Reserved | A_EN |
| Reset Value | 0 | 0 | 0 | 0 | 0 | 1 | 0 | 1 |

Output Voltage Enable Register 1 (OVER1) 8h'10 Definitions

| Bit | Access | Name | Description |
|-----|--------|------|---|
| 7-3 | — | — | Reserved |
| 2 | R/W | S_EN | V _{CC-SRAM} (LDO5) Supply Output Enabled 0 = V _{CC-SRAM} (LDO5) Supply Output Disabled 1 = V _{CC-SRAM} (LDO5) Supply Output Enabled |
| 1 | — | — | Reserved |
| 0 | R/W | A_EN | V _{CC-APPS} (Buck1) Supply Output Enabled 0 = V _{CC-APPS} (BUCK1) Supply Output Disabled 1 = V _{CC-APPS} (BUCK1) Supply Output Enabled |

OUTPUT VOLTAGE STATUS REGISTER

This 8 bit register is used to indicate the status of the low voltage supplies. By polling each of the specify supplies is within its specified operating range.

Output Voltage Status Register 1 (OVS1) 8h'11

| Bit | 7 | 6 | 5 | 4 | 3 | 2 | 1 | 0 |
|-------------|-------|----------|---|---|---|------|----------|------|
| Designation | LP_OK | Reserved | | | | S_OK | Reserved | A_OK |
| Reset Value | 0 | 0 | 0 | 0 | 0 | 0 | 0 | 0 |

Output Voltage Status Register 1 (OVS1) 8h'11 Definitions

| Bit | Access | Name | Description |
|-----|--------|-------|--|
| 7 | R | LP_OK | Low Voltage Supply Output Voltage Status 0 - V _{CC-APPS} (Buck1) & V _{CC-SRAM} (LDO5) output voltage < 90% of selected value 1 - V _{CC-APPS} (Buck1) & V _{CC-SRAM} (LDO5) output voltage > 90% of selected value |
| 6:3 | — | — | Reserved |
| 2 | R | S_OK | V _{CC-SRAM} Supply Output Voltage Status 0 - V _{CC-SRAM} (LDO5) output voltage < 90% of selected value 1 - V _{CC-SRAM} (LDO5) output voltage > 90% of selected value |
| 1 | — | — | Reserved |
| 0 | R | A_OK | V _{CC-APPS} Supply output Voltage Status 0 - V _{CC-APPS} (BUCK1) output voltage < 90% of selected value 1 - V _{CC-APPS} (BUCK1) output voltage > 90% of selected value |

OUTPUT VOLTAGE ENABLE REGISTER 2

[查询"LP3972SQ-A514"供应商](#)

This 8 bit output register enables and disables the output voltages on the LDO 2,3,4 supplies.

Output Voltage Enable Register 2 (OVER2) 8h'12

| Bit | 7 | 6 | 5 | 4** | 3** | 2** | 1 | 0 |
|-------------|----------|---|---|---------|---------|---------|----------|---|
| Designation | Reserved | | | LDO4_EN | LDO3_EN | LDO2_EN | Reserved | |
| Reset Value | 0 | 0 | 0 | 0 | 0 | 0 | 0 | 0 |

Note: ** denotes one time factory programmable EPROM registers for default values

Output Voltage Enable Register 2 (OVER2) 8h'12 Definitions

| Bit | Access | Name | Description |
|-----|--------|---------|---|
| 7 | — | — | Reserved |
| 6 | — | — | Reserved |
| 5 | — | — | Reserved |
| 4 | R/W | LDO4_EN | LDO_4 Output Voltage Enable 0 = LDO4 Supply Output Disabled, Default 1 = LDO4 Supply Output Enabled |
| 3 | R/W | LDO3_EN | LDO_3 Output Voltage Enable 0 = LDO3 Supply Output Disabled, Default 1 = LDO3 Supply Output Enabled |
| 2 | R/W | LDO2_EN | LDO_2 Output Voltage Enable 0 = LDO2 Supply Output Disabled, Default 1 = LDO2 Supply Output Enabled |
| 1 | — | — | Reserved |
| 0 | — | — | Reserved |

OUTPUT VOLTAGE ENABLE REGISTER 2**Output Voltage Status Register 2 (OVSR2) 8h'13**

| Bit | 7 | 6 | 5 | 4 | 3 | 2 | 1 | 0 |
|-------------|--------|-----|-----|---------|---------|---------|-----|-----|
| Designation | LDO_OK | N/A | N/A | LDO4_OK | LDO3_OK | LDO2_OK | N/A | N/A |
| Reset Value | 0 | 0 | 0 | 0 | 0 | 0 | 0 | 0 |

Output Voltage Status Register 2 (OVSR2) 8h'13 Definitions

| Bit | Access | Name | Description |
|-----|--------|---------|---|
| 7 | R | LDO_OK | LDO 2-4 Supply Output Voltage Status 0 - (LDO 2-4) output voltage < 90% of selected value 1 - (LDO 2-4) output voltage > 90% of selected value |
| 6 | — | — | Reserved |
| 5 | — | — | Reserved |
| 4 | R | LDO4_OK | LDO_4 Output Voltage Status 0 - (V _{CC} -LDO4) output voltage < 90% of selected value 1 - (V _{CC} -LDO4) output voltage > 90% of selected value |
| 3 | R | LDO3_OK | LDO_3 Output Voltage Status 0 - (V _{CC} -LDO3) output voltage < 90% of selected value 1 - (V _{CC} -LDO3) output voltage > 90% of selected value |
| 2 | R | LDO2_OK | LDO_2 Output Voltage Status 0 - (V _{CC} -LDO2) output voltage < 90% of selected value 1 - (V _{CC} -LDO2) output voltage > 90% of selected value |
| 1 | — | — | Reserved |
| 0 | — | — | Reserved |

DVM VOLTAGE CHANGE CONTROL REGISTER 1DVM Voltage Change Control Register 1 (V_{CC1}) 8h'20

| Bit | 7 | 6 | 5 | 4 | 3 | 2 | 1 | 0 |
|-------------|-----|-----|-----|-----|----------|---|-----|-----|
| Designation | MVS | MGO | SVS | SGO | Reserved | | AVS | AGO |
| Reset Value | 0 | 0 | 0 | 0 | 0 | 0 | 0 | 0 |

DVM Voltage Change Control Register 1 (V_{CC1}) 8h'20 Definitions

| Bit | Access | Name | Description |
|-----|--------|------|--|
| 7 | R/W | MVS | V_{CC_MVT} (LDO1) Voltage Select 0 - Change V_{CC_MVT} Output Voltage to MDVT1 1 - Change V_{CC_MVT} Output Voltage to MDVT2 |
| 6 | R/W | MGO | Start V_{CC_MVT} (LDO1) Voltage Change 0 - Hold V_{CC_MVT} Output Voltage at current Level 1 - Ramp V_{CC_MVT} Output Voltage as selected by MVS |
| 5 | R/W | SVS | V_{CC_SRAM} (LDO5) Voltage Select 0 - Change V_{CC_SRAM} Output Voltage to SDTV1 1 - Change V_{CC_SRAM} Output Voltage to SDTV2 |
| 4 | R/W | SGO | Start V_{CC_SRAM} (LDO5) Voltage Change 0 - Hold V_{CC_SRAM} Output Voltage at current Level 1 - Change V_{CC_SRAM} Output Voltage as selected by SVS |
| 3:2 | — | — | Reserved |
| 1 | R/W | AVS | V_{CC_APPS} (Buck 1) Voltage Select 0 - Ramp V_{CC_APPS} Output Voltage to ADVT1 1 - Ramp V_{CC_APPS} Output Voltage to ADVT2 |
| 0 | R/W | AGO | Start V_{CC_APPS} (Buck1) Voltage Change 0 - Hold V_{CC_APPS} Output Voltage at current Level 1 - Ramp V_{CC_APPS} Output Voltage as selected by AVS |

BUCK1 (V_{CC-APPS}) VOLTAGE 1

[查询"LP3972SQ-A514"供应商](#)

Buck1 (V_{CC-APPS}) Target Voltage 1 Register (ADTV1) 8h'23

| Bit | 7 | 6 | 5 | 4** | 3** | 2** | 1** | 0** |
|-------------|----------|---|---|-------------------------------|-----|-----|-----|-----|
| Designation | Reserved | | | Buck 1 Output Voltage (B1OV1) | | | | |
| Reset Value | 0 | 0 | 0 | 0 | 1 | 0 | 1 | 1 |

Note: ** denotes one time factory programmable

Buck1 (V_{CC-APPS}) Target Voltage 1 Register (ADTV1) 8h'23 Definitions

| Bit | Access | Name | Description | | | |
|-----|--------|-------|------------------|-----------------------|------------------|-----------------------|
| 7:5 | — | — | Reserved | | | |
| 4:0 | R/W | B1OV1 | Data Code | Output Voltage | Data Code | Output Voltage |
| | | | 5h'0 | 0.725 | 5h'10 | 1.125 |
| | | | 5h'1 | 0.750 | 5h'11 | 1.150 |
| | | | 5h'2 | 0.775 | 5h'12 | 1.175 |
| | | | 5h'3 | 0.800 | 5h'13 | 1.200 |
| | | | 5h'4 | 0.825 | 5h'14 | 1.225 |
| | | | 5h'5 | 0.850 | 5h'15 | 1.250 |
| | | | 5h'6 | 0.875 | 5h'16 | 1.275 |
| | | | 5h'7 | 0.900 | 5h'17 | 1.300 |
| | | | 5h'8 | 0.925 | 5h'18 | 1.325 |
| | | | 5h'9 | 0.950 | 5h'19 | 1.350 |
| | | | 5h'A | 0.975 | 5h'1A | 1.375 |
| | | | 5h'B | 1.000 | 5h'1B | 1.400 |
| | | | 5h'C | 1.025 | 5h'1C | 1.425 |
| | | | 5h'D | 1.050 | 5h'1D | 1.450 |
| | | | 5h'E | 1.075 | 5h'1E | 1.475 |
| | | | 5h'F | 1.100 | 5h'1F | 1.500 |

BUCK1 (V_{CC}_APPS) TARGET VOLTAGE 2 REGISTERBuck1 (V_{CC}_APPS) Target Voltage 2 Register (ADTV2) 8h'24

| Bit | 7 | 6 | 5 | 4 | 3 | 2 | 1 | 0 |
|-------------|----------|---|---|-------------------------------|---|---|---|---|
| Designation | Reserved | | | Buck 1 Output Voltage (B1OV2) | | | | |
| Reset Value | 0 | 0 | 0 | 0 | 1 | 0 | 1 | 1 |

Buck1 (V_{CC}_APPS) Target Voltage 2 Register (ADTV2) 8h'24 Definitions

| Bit | Access | Name | Description | | | |
|-----|--------|-------|------------------|-----------------------|------------------|-----------------------|
| 7:5 | — | — | Reserved | | | |
| 4:0 | R/W | B1OV2 | Data Code | Output Voltage | Data Code | Output Voltage |
| | | | 5h'0 | 0.725 | 5h'10 | 1.125 |
| | | | 5h'1 | 0.750 | 5h'11 | 1.150 |
| | | | 5h'2 | 0.775 | 5h'12 | 1.175 |
| | | | 5h'3 | 0.800 | 5h'13 | 1.200 |
| | | | 5h'4 | 0.825 | 5h'14 | 1.225 |
| | | | 5h'5 | 0.850 | 5h'15 | 1.250 |
| | | | 5h'6 | 0.875 | 5h'16 | 1.275 |
| | | | 5h'7 | 0.900 | 5h'17 | 1.300 |
| | | | 5h'8 | 0.925 | 5h'18 | 1.325 |
| | | | 5h'9 | 0.950 | 5h'19 | 1.350 |
| | | | 5h'A | 0.975 | 5h'1A | 1.375 |
| | | | 5h'B | 1.000 | 5h'1B | 1.400 |
| | | | 5h'C | 1.025 | 5h'1C | 1.425 |
| | | | 5h'D | 1.050 | 5h'1D | 1.450 |
| | | | 5h'E | 1.075 | 5h'1E | 1.475 |
| | | | 5h'F | 1.100 | 5h'1F | 1.500 |

BUCK1 (V_{CC-APPS}) VOLTAGE RAMP CONTROL REGISTER

[查询"LP3972SQ-A514"供应商](#)

Buck1 (V_{CC-APPS}) Voltage Ramp Control Register (AVRC) 8h'25

| Bit | 7 | 6 | 5 | 4 | 3 | 2 | 1 | 0 |
|-------------|----------|---|---|------------------|---|---|---|---|
| Designation | Reserved | | | Ramp Rate (B1RR) | | | | |
| Reset Value | 0 | 0 | 0 | 0 | 1 | 0 | 1 | 0 |

Buck 1 (V_{CC-APPS}) Voltage Ramp Control Register (AVRC) 8h'25 Definitions

| Bit | Access | Name | Description | |
|-------------|-----------|------|------------------|--------------------------|
| 7:5 | — | — | Reserved | |
| 4:0 | R/W | B1RR | DVM Ramp Speed | |
| | | | Data Code | Ramp Rate (mV/uS) |
| | | | 5h'0 | Instant |
| | | | 5h'1 | 1 |
| | | | 5h'2 | 2 |
| | | | 5h'3 | 3 |
| | | | 5h'4 | 4 |
| | | | 5h'5 | 5 |
| | | | 5h'6 | 6 |
| | | | 5h'7 | 7 |
| | | | 5h'8 | 8 |
| 5h'9 | 9 | | | |
| 5h'A | 10 | | | |
| 4h'B-4h'1F | Reserved | | | |

V_{CC}-COMM TARGET VOLTAGE 1 DUMMY REGISTER (CDTV1)**V_{CC}-COMM Target Voltage 1 Dummy Register (CDTV1) 8h'26 Write Only**

| Bit | 7 | 6 | 5 | 4 | 3 | 2 | 1 | 0 |
|-------------|----------|---|---|----------------|---|---|---|---|
| Designation | Reserved | | | Output Voltage | | | | |
| Reset Value | 0 | 0 | 0 | 0 | 0 | 0 | 0 | 0 |

Note: CDTV1 must be writable by an I²C controller. This is a dummy register

V_{CC}-COMM TARGET VOLTAGE 2 DUMMY REGISTER (CDTV2)**V_{CC}-COMM Target Voltage 2 Dummy Register (CDTV2) 8h'27 Write Only**

| Bit | 7 | 6 | 5 | 4 | 3 | 2 | 1 | 0 |
|-------------|----------|---|---|----------------|---|---|---|---|
| Designation | Reserved | | | Output Voltage | | | | |
| Reset Value | 0 | 0 | 0 | 0 | 0 | 0 | 0 | 0 |

Note: CDTV2 must be writable by an I²C controller. This is a dummy register and can not be read.

This is a variable voltage supply to the internal SRAM of the Application processor.

LDO 5 (V_{CC}-SRAM) TARGET VOLTAGE 1 REGISTER**LDO 5 (V_{CC}-SRAM) Target Voltage 1 Register (SDTV1) 8H'29**

| Bit | 7 | 6 | 5 | 4** | 3** | 2** | 1** | 0** |
|-------------|----------|---|---|-----------------------------|-----|-----|-----|-----|
| Designation | Reserved | | | LDO 5 Output Voltage (L5OV) | | | | |
| Reset Value | 0 | 0 | 0 | 0 | 1 | 0 | 1 | 1 |

Note: ** denotes one time factory programmable EPROM registers for default values

LDO 5 (V_{CC}-SRAM) Target Voltage 1 Register (SDTV1) 8h'29 Definitions

| Bit | Access | Name | Description | | | |
|-----|--------|------|------------------|-----------------------|------------------|-----------------------|
| 7:5 | — | — | Reserved | | | |
| 4:0 | R/W | B1OV | Data Code | Output Voltage | Data Code | Output Voltage |
| | | | 5h'0 | — | 5h'10 | 1.125 |
| | | | 5h'1 | — | 5h'11 | 1.150 |
| | | | 5h'2 | — | 5h'12 | 1.175 |
| | | | 5h'3 | — | 5h'13 | 1.200 |
| | | | 5h'4 | — | 5h'14 | 1.225 |
| | | | 5h'5 | 0.850 | 5h'15 | 1.250 |
| | | | 5h'6 | 0.875 | 5h'16 | 1.275 |
| | | | 5h'7 | 0.900 | 5h'17 | 1.300 |
| | | | 5h'8 | 0.925 | 5h'18 | 1.325 |
| | | | 5h'9 | 0.950 | 5h'19 | 1.350 |
| | | | 5h'A | 0.975 | 5h'1A | 1.375 |
| | | | 5h'B | 1.000 | 5h'1B | 1.400 |
| | | | 5h'C | 1.025 | 5h'1C | 1.425 |
| | | | 5h'D | 1.050 | 5h'1D | 1.450 |
| | | | 5h'E | 1.075 | 5h'1E | 1.475 |
| | | | 5h'F | 1.100 | 5h'1F | 1.500 |

LDO 5 (V_{CC_SRAM}) TARGET VOLTAGE 2 REGISTER
[查询"LP3972SQ-A514"供应商](#)
LDO 5 (V_{CC_SRAM}) Target Voltage 2 Register (SDTV2) 8h'2A

| Bit | 7 | 6 | 5 | 4 | 3 | 2 | 1 | 0 |
|-------------|----------|---|---|-----------------------------|---|---|---|---|
| Designation | Reserved | | | LDO 5 Output Voltage (L5OV) | | | | |
| Reset Value | 0 | 0 | 0 | 0 | 1 | 0 | 1 | 1 |

LDO 5 (V_{CC_SRAM}) Target Voltage 2 Register (SDTV2) 8h'2A Definitions

| Bit | Access | Name | Description | | | |
|-----|--------|------|------------------|-----------------------|------------------|-----------------------|
| 7:5 | — | — | Reserved | | | |
| 4:0 | R/W | B1OV | Data Code | Output Voltage | Data Code | Output Voltage |
| | | | 5h'0 | — | 5h'10 | 1.125 |
| | | | 5h'1 | — | 5h'11 | 1.150 |
| | | | 5h'2 | — | 5h'12 | 1.175 |
| | | | 5h'3 | — | 5h'13 | 1.200 |
| | | | 5h'4 | — | 5h'14 | 1.225 |
| | | | 5h'5 | 0.850 | 5h'15 | 1.250 |
| | | | 5h'6 | 0.875 | 5h'16 | 1.275 |
| | | | 5h'7 | 0.900 | 5h'17 | 1.300 |
| | | | 5h'8 | 0.925 | 5h'18 | 1.325 |
| | | | 5h'9 | 0.950 | 5h'19 | 1.350 |
| | | | 5h'A | 0.975 | 5h'1A | 1.375 |
| | | | 5h'B | 1.000 | 5h'1B | 1.400 |
| | | | 5h'C | 1.025 | 5h'1C | 1.425 |
| | | | 5h'D | 1.050 | 5h'1D | 1.450 |
| | | | 5h'E | 1.075 | 5h'1E | 1.475 |
| | | | 5h'F | 1.100 | 5h'1F | 1.500 |

V_{CC_MVT} is low tolerance regulated power supply for the application processor ring oscillator and logic for communicating to the LP3972. V_{CC_MVT} is enabled when SYS_EN is asserted and disabled when SYS_EN is deasserted.

LDO 1 (V_{CC-MVT}) TARGET VOLTAGE 1 REGISTER (MDTV1)LDO 1 (V_{CC-MVT}) Target Voltage 1 Register (MDTV1) 8h'32

| Bit | 7 | 6 | 5 | 4** | 3** | 2** | 1** | 0** |
|-------------|----------|---|---|---------------------|-----|-----|-----|-----|
| Designation | Reserved | | | Output Voltage (OV) | | | | |
| Reset Value | 0 | 0 | 0 | 0 | 0 | 1 | 0 | 0 |

Note: ** denotes one time factory programmable EPROM registers for default values

LDO 1 (V_{CC-MVT}) Target Voltage 1 Register (MDTV1) 8h'32 Definitions

| Bit | Access | Name | Description | | |
|-----|--------|------|------------------|-----------------------|--------|
| 7:5 | — | — | Reserved | | |
| 4:0 | R/W | L1OV | Data Code | Output Voltage | Notes: |
| | | | 5h'0 | 1.700 | |
| | | | 5h'1 | 1.725 | |
| | | | 5h'2 | 1.750 | |
| | | | 5h'3 | 1.775 | |
| | | | 5h'4 | 1.800 | |
| | | | 5h'5 | 1.825 | |
| | | | 5h'6 | 1.850 | |
| | | | 5h'7 | 1.875 | |
| | | | 5h'8 | 1.900 | |
| | | | 5h'9 | 1.925 | |
| | | | 5h'A | 1.950 | |
| | | | 5h'B | 1.975 | |
| | | | 5h'C | 2.000 | |
| | | | 5h'D-5h'F | Reserved | |

LDO 1 (V_{CC-MVT}) TARGET VOLTAGE 2 REGISTER

[查询"LP3972SQ-A514"供应商](#)

LDO 1 (V_{CC-MVT}) Target Voltage 2 Register (MDTV2) 8h'33

| Bit | 7 | 6 | 5 | 4 | 3 | 2 | 1 | 0 |
|-------------|----------|---|---|---------------------|---|---|---|---|
| Designation | Reserved | | | Output Voltage (OV) | | | | |
| Reset Value | 0 | 0 | 0 | 0 | 1 | 0 | 1 | 1 |

LDO 1 (V_{CC-MVT}) Target Voltage 2 Register (MDTV2) 8h'33 Definitions

| Bit | Access | Name | Description | | |
|-----|--------|------|--|---|--------|
| 7:5 | — | — | Reserved | | |
| 4:0 | R/W | L1OV | Data Code 5h'0 5h'1 5h'2 5h'3 5h'4 5h'5 5h'6 5h'7 5h'8 5h'9 5h'A 5h'B 5h'C 5h'D-5h'F | Output Voltage 1.700 1.725 1.750 1.775 1.800 1.825 1.850 1.875 1.900 1.925 1.950 1.975 2.000 Reserved | Notes: |

LDO2 VOLTAGE CONTROL REGISTER (L12VCR)

LDO2 Voltage Control Register (L12VCR) 8h'39

| Bit | 7** | 6** | 5** | 4** | 3 | 2 | 1 | 0 |
|-------------|-----------------------------|-----|-----|-----|----------|---|---|---|
| Designation | LDO 2 Output Voltage (L2OV) | | | | Reserved | | | |
| Reset Value | 0 | 0 | 0 | 0 | 0 | 0 | 0 | 0 |

Note: ** denotes one time factory programmable EPROM registers for default values

LDO2 Voltage Control Register (L12VCR) 8h'39 Definitions

| Bit | Access | Name | Description | | |
|-----|--------|------|--|---|-------------------|
| 7:4 | R/W | L2OV | Data Code 4h'0 4h'1 4h'2 4h'3 4h'4 4h'5 4h'6 4h'7 4h'8 4h'9 4h'A 4h'B 4h'C 4h'D 4h'E 4h'F | Output Voltage 1.8 1.9 2.0 2.1 2.2 2.3 2.4 2.5 2.6 2.7 2.8 2.9 3.0 3.1 3.2 3.3 | Notes: Default |
| 3:0 | — | — | Reserved | | |

NSC DEFINED CONTROL AND STATUS REGISTERS

SYSTEM CONTROL REGISTER 1 (SCR1)
[查询"LP3972SQ-A514"供应商](#)

System Control Register 1 (SCR1) 8h'80

| Bit | 7** | 6** | 5** | 4 | 3 | 2 | 1 | 0 |
|-------------|-------|-------|-----|-------|-------|-------|-----------|---------|
| Designation | BPSEN | SENDL | | FPWM3 | FPWM2 | FPWM1 | BK_SLOMOD | BK_SSEN |
| Reset Value | 0 | 1 | 0 | 0 | 0 | 0 | 0 | 0 |

Note: ** denotes one time factory programmable EPROM registers for default values

System Control Register 1 (SCR1) 8h'80 Definitions

| Bit | Access | Name | Description | | | | | | | | | | | | | | | |
|-------------|------------|-----------|---|-----------|----------|--------|------|-----|--|------|-----|--|-------------|------------|---------|------|-----|--|
| 7 | R/W | BPSEN | Bypass System enable safety Lock. Prevents activation of PWR_EN when SYS_EN is low. 0 = PWR_EN "AND" with SYS_EN signal, Default 1 = PWR_EN independent of SYS_EN | | | | | | | | | | | | | | | |
| 6:5 | R/W | SENDL | Delay time for High Voltage Power Domains LDO2, LDO3, LDO4, Buck2, and Buck3 after activation of SYS_EN. V _{CC-LDO1} has no delay. <table border="1"> <thead> <tr> <th>Data Code</th> <th>Delay mS</th> <th>Notes:</th> </tr> </thead> <tbody> <tr> <td>2h'0</td> <td>0.0</td> <td></td> </tr> <tr> <td>2h'1</td> <td>0.5</td> <td></td> </tr> <tr> <td>2h'2</td> <td>1.0</td> <td>Default</td> </tr> <tr> <td>2h'3</td> <td>1.4</td> <td></td> </tr> </tbody> </table> | Data Code | Delay mS | Notes: | 2h'0 | 0.0 | | 2h'1 | 0.5 | | 2h'2 | 1.0 | Default | 2h'3 | 1.4 | |
| Data Code | Delay mS | Notes: | | | | | | | | | | | | | | | | |
| 2h'0 | 0.0 | | | | | | | | | | | | | | | | | |
| 2h'1 | 0.5 | | | | | | | | | | | | | | | | | |
| 2h'2 | 1.0 | Default | | | | | | | | | | | | | | | | |
| 2h'3 | 1.4 | | | | | | | | | | | | | | | | | |
| 4 | R/W | FPWM3 | Buck 3 PWM/PFM Mode select 0 - Auto Switch between PFM and PWM operation 1 - PWM Mode Only will not switch to PFM | | | | | | | | | | | | | | | |
| 3 | R/W | FPWM2 | Buck 2 PWM/PFM Mode select 0 - Auto Switch between PFM and PWM operation 1 - PWM Mode Only will not switch to PFM | | | | | | | | | | | | | | | |
| 2 | R/W | FPWM1 | Buck 1 PWM/PFM Mode select 0 - Auto Switch between PFM and PWM operation 1 - PWM Mode Only will not switch to PFM | | | | | | | | | | | | | | | |
| 1 | R | BK_SLOMOD | Buck Spread Spectrum Modulation Buck 1-3 0 = 10 kHz triangular wave spread spectrum modulation 1 = 2 kHz triangular wave spread spectrum modulation | | | | | | | | | | | | | | | |
| 0 | R | BK_SSEN | Spread spectrum function Buck 1-3 0 = SS Output Disabled 1 = SS Output Enabled | | | | | | | | | | | | | | | |

SYSTEM CONTROL REGISTER 2 (SCR2)

[查询"LP3972SQ-A514"供应商](#)

System Control Register 2 (SCR2) 8h'81

| Bit | 7 | 6 | 5** | 4 | 3 | 2 | 1 | 0 |
|-------------|------|------|------|------|-------|---|-------|---|
| Designation | BBCS | SHBU | BPTR | WUP3 | GPIO2 | | GPIO1 | |
| | 1 | 0 | 1 | 1 | 0 | 0 | 1 | 0 |

Note: ** denotes one time factory programmable EPROM registers for default values

System Control Register 2 (SCR2) 8h'81 Definitions

| Bit | Access | Name | Description | | | | | | | | | | |
|------------------|--------------|-------|---|------------------|--------------|-------|------|-------|------------|-------|-------|-------|-------------|
| 7 | R/W | BBCS | Sets GPIO1 as control input for Back Up battery charger 0 - Back Up battery Charger GPIO Disabled 1 - Back Up battery Charger GPIO Pin Enabled | | | | | | | | | | |
| 6 | R/W | SHBU | Shut down Back up battery to prevent battery drain during shipping 0 = Back up Battery Enabled 1 = Back up battery Disabled | | | | | | | | | | |
| 5 | R/W | BPTR | Bypass RTC_LDO Output Voltage to LDO 3 Output Voltage Tracking 0 - RTC-LDO 3 Tracking enabled 1 - RTC-LDO 3 Tracking disabled, Default | | | | | | | | | | |
| 4 | R/W | WUP3 | Spare Wakeup control input 0 - Active High 1 - Active Low | | | | | | | | | | |
| 3:2 | R/W | GPIO2 | Configure direction and output sense of GPIO2 Pin <table border="0"> <tr> <td>Data Code</td> <td>GPIO2</td> </tr> <tr> <td>2h'00</td> <td>Hi-Z</td> </tr> <tr> <td>2h'01</td> <td>Output Low</td> </tr> <tr> <td>2h'02</td> <td>Input</td> </tr> <tr> <td>2h'03</td> <td>Output high</td> </tr> </table> | Data Code | GPIO2 | 2h'00 | Hi-Z | 2h'01 | Output Low | 2h'02 | Input | 2h'03 | Output high |
| Data Code | GPIO2 | | | | | | | | | | | | |
| 2h'00 | Hi-Z | | | | | | | | | | | | |
| 2h'01 | Output Low | | | | | | | | | | | | |
| 2h'02 | Input | | | | | | | | | | | | |
| 2h'03 | Output high | | | | | | | | | | | | |
| 1:0 | R/W | GPIO1 | Configure direction and output sense of GPIO1 Pin <table border="0"> <tr> <td>Data Code</td> <td>GPIO1</td> </tr> <tr> <td>2h'00</td> <td>Hi-Z</td> </tr> <tr> <td>2h'01</td> <td>Output Low</td> </tr> <tr> <td>2h'02</td> <td>Input</td> </tr> <tr> <td>2h'03</td> <td>Output high</td> </tr> </table> | Data Code | GPIO1 | 2h'00 | Hi-Z | 2h'01 | Output Low | 2h'02 | Input | 2h'03 | Output high |
| Data Code | GPIO1 | | | | | | | | | | | | |
| 2h'00 | Hi-Z | | | | | | | | | | | | |
| 2h'01 | Output Low | | | | | | | | | | | | |
| 2h'02 | Input | | | | | | | | | | | | |
| 2h'03 | Output high | | | | | | | | | | | | |

OUTPUT ENABLE 3 REGISTER (OEN3) 8H'82

查询"LP3972SQ-A514"供应商

| Bit | 7 | 6 | 5 | 4** | 3 | 2** | 1 | 0** |
|-------------|----------|---|---|------|--------|------|----------|------|
| Designation | Reserved | | | B3EN | ENFLAG | B2EN | Reserved | L1EN |
| Reset Value | 0 | 0 | 0 | 1 | 0 | 1 | 0 | 1 |

Note: ** denotes one time factory programmable EPROM registers for default values

OUTPUT ENABLE 3 REGISTER (OEN3) 8H'82 DEFINITIONS

| Bit | Access | Name | Description |
|-----|--------|--------|---|
| 7:5 | — | — | Reserved |
| 4 | R/W | B3EN | V _{CC_Buck3} Supply Output Enabled 0 = V _{CC_Buck3} Supply Output Disabled 1 = V _{CC_Buck3} Supply Output Enabled, Default |
| 3 | R/W | ENFLAG | Enable for Temperature Flags (BCT) 0 = Temperature Flag Disabled 1 = Temperature Flag Enabled |
| 2 | R/W | B2EN | V _{CC_Buck2} Supply Output Enabled 0 = V _{CC_Buck2} Supply Output Disabled 1 = V _{CC_Buck2} Supply Output Enabled, Default |
| 1 | — | — | Reserved |
| 0 | R/W | L1EN | LDO_1 (MVT) Output Voltage Enable 0 = LDO1 Supply Output Disabled 1 = LDO1 Supply Output Enabled, Default |

STATUS REGISTER 3 (OSR3) 8H'83

| Bit | 7 | 6 | 5 | 4 | 3 | 2 | 1 | 0 |
|-------------|-------|-------|-------|---------|----------|------|------|------|
| Designation | BT_OK | B3_OK | B2_OK | LDO1_OK | Reserved | BCT2 | BCT1 | BCT0 |
| Reset Value | 0 | 0 | 0 | 0 | 0 | 0 | 0 | 0 |

STATUS REGISTER 3 (OSR3) DEFINITIONS 8H'83

| Bit | Access | Name | Description |
|-----|--------|---------|---|
| 7 | R | BT_OK | Buck 2-3 Supply Output Voltage Status 0 - (Buck 1-3) output voltage < 90% Default value 1 - (Buck 1-3) output voltage > 90% Default value |
| 6 | R | B3_OK | Buck 3 Supply Output Voltage Status 0 - (Buck 3) output voltage < 90% Default value 1 - (Buck 3) output voltage > 90% Default value |
| 5 | R | B2_OK | Buck 2 Supply Output Voltage Status 0 - (Buck 2) output voltage < 90% Default value 1 - (Buck 2) output voltage > 90% Default value |
| 4 | R | LDO1_OK | LDO_1 Output Voltage Status 0 - (V _{CC_LDO1}) output voltage < 90% of selected value 1 - (V _{CC_LDO1}) output voltage > 90% of selected value |
| 3 | — | — | Reserved |

| Bit | Access | Name | Description | | | | | | | | | | | | | | | | | | |
|-----------|--------------------------|------|---|-----------|--------------------------|-----|----|-----|----|-----|----|-----|-----|-----|-----|-----|-----|-----|-----|-----|----------|
| 2:0 | R | BCT | Binary coded thermal management flag status register | | | | | | | | | | | | | | | | | | |
| | | | <table border="0"> <thead> <tr> <th>Data Code</th> <th>Temperature Ascending °C</th> </tr> </thead> <tbody> <tr> <td>000</td> <td>40</td> </tr> <tr> <td>001</td> <td>60</td> </tr> <tr> <td>010</td> <td>80</td> </tr> <tr> <td>011</td> <td>100</td> </tr> <tr> <td>100</td> <td>120</td> </tr> <tr> <td>101</td> <td>140</td> </tr> <tr> <td>110</td> <td>160</td> </tr> <tr> <td>111</td> <td>Reserved</td> </tr> </tbody> </table> | Data Code | Temperature Ascending °C | 000 | 40 | 001 | 60 | 010 | 80 | 011 | 100 | 100 | 120 | 101 | 140 | 110 | 160 | 111 | Reserved |
| Data Code | Temperature Ascending °C | | | | | | | | | | | | | | | | | | | | |
| 000 | 40 | | | | | | | | | | | | | | | | | | | | |
| 001 | 60 | | | | | | | | | | | | | | | | | | | | |
| 010 | 80 | | | | | | | | | | | | | | | | | | | | |
| 011 | 100 | | | | | | | | | | | | | | | | | | | | |
| 100 | 120 | | | | | | | | | | | | | | | | | | | | |
| 101 | 140 | | | | | | | | | | | | | | | | | | | | |
| 110 | 160 | | | | | | | | | | | | | | | | | | | | |
| 111 | Reserved | | | | | | | | | | | | | | | | | | | | |

LOGIC OUTPUT ENABLE REGISTER (LOER) 8H'84

查询"LP3972SQ-A514"供应商

| Bit | 7 | 6* | 5* | 4* | 3* | 2* | 1* | 0* |
|-------------|----------|-------|-------|-------|------|------|------|------|
| Designation | Reserved | B3ENC | B2ENC | B1ENC | L5EC | L4EC | L3EC | L2EC |
| Reset Value | 0 | 1 | 1 | 0 | 0 | 1 | 1 | 1 |

Note: ** denotes one time factory programmable EPROM registers for default values

LOGIC OUTPUT ENABLE REGISTER (LOER) DEFINITIONS 8H'84

| Bit | Access | Name | Description |
|-----|--------|-------|---|
| 7 | — | — | Reserved |
| 6 | R/W | B3ENC | Connects Buck 3 enable to SYS_EN or PWR_EN Logic Control pin 0 - Buck 3 enable connected to PWR_EN 1 - Buck 3 enable connected to SYS_EN, Default |
| 5 | R/W | B2ENC | Connects Buck 2 enable to SYS_EN or PWR_EN Logic Control pin 0 - Buck 2 enable connected to PWR_EN 1 - Buck 2 enable connected to SYS_EN, Default |
| 4 | R/W | B1ENC | Connects Buck 1 enable to SYS_EN or PWR_EN Logic Control pin 0 - Buck 1 enable connected to PWR_EN, Default 1 - Buck 1 enable connected to SYS_EN |
| 3 | R/W | L5EC | Connects LDO5 enable to SYS_EN or PWR_EN Logic Control pin 0 - LDO 5 enable connected to PWR_EN, Default 1 - LDO 5 enable connected to SYS_EN |
| 2 | R/W | L4EC | Connects LDO4 enable to SYS_EN or PWR_EN Logic Control pin 0 - LDO 4 enable connected to PWR_EN 1 - LDO 4 enable connected to SYS_EN, Default |
| 1 | R/W | L3EC | Connects LDO3 enable to SYS_EN or PWR_EN Logic Control pin 0 - LDO 3 enable connected to PWR_EN 1 - LDO 3 enable connected to SYS_EN, Default |
| 0 | R/W | L2EC | Connects LDO2 enable to SYS_EN or PWR_EN Logic Control pin 0 - LDO 2 enable connected to PWR_EN 1 - LDO 2 enable connected to SYS_EN, Default |

V_{CC}-BUCK 2 TARGET VOLTAGE REGISTER (B2TV) 8H'85
[查询"LP3972SQ-A514"供应商](#)

| Bit | 7 | 6 | 5 | 4** | 3** | 2** | 1** | 0** |
|-------------|----------|---|---|------------------------------|-----|-----|-----|-----|
| Designation | Reserved | | | Buck 2 Output Voltage (B2OV) | | | | |
| Reset Value | 0 | 0 | 0 | 1 | 1 | 0 | 0 | 1 |

Note: ** denotes one time factory programmable EPROM registers for default values

V_{CC}-BUCK 2 TARGET VOLTAGE REGISTER (B2TV) 8H'85 DEFINITIONS

| Bit | Access | Name | Description | | | | | | | | | | | | | | | | | | | | | | | | | | | | | | | | | | | | | | | | | | | | | | | | | | | | | | | | |
|-----------|--------|--------------|---|-----------|-----|-----------|-----|-------|------|-------|------|-------|------|-------|------|-------|------|-------|------|-------|------|-------|------|-------|------|-------|------|-------|------|-------|------|-------|------|-------|------|-------|------|-------|------|-------|------|-------|------|-------|------|-------|------|-------|------|-------|------|-------|------|-------|------|--|--|--------------|-------------|
| 7:5 | — | | Reserved | | | | | | | | | | | | | | | | | | | | | | | | | | | | | | | | | | | | | | | | | | | | | | | | | | | | | | | | |
| 4:0 | R/W | B2OV | Output Voltage | | | | | | | | | | | | | | | | | | | | | | | | | | | | | | | | | | | | | | | | | | | | | | | | | | | | | | | | |
| | | | <table border="1"> <thead> <tr> <th>Data Code</th> <th>(V)</th> <th>Data Code</th> <th>(V)</th> </tr> </thead> <tbody> <tr><td>5h'01</td><td>0.80</td><td>5h'0D</td><td>1.40</td></tr> <tr><td>5h'02</td><td>0.85</td><td>5h'0E</td><td>1.45</td></tr> <tr><td>5h'03</td><td>0.90</td><td>5h'0F</td><td>1.50</td></tr> <tr><td>5h'04</td><td>0.95</td><td>5h'10</td><td>1.55</td></tr> <tr><td>5h'05</td><td>1.00</td><td>5h'11</td><td>1.60</td></tr> <tr><td>5h'06</td><td>1.05</td><td>5h'12</td><td>1.65</td></tr> <tr><td>5h'07</td><td>1.10</td><td>5h'13</td><td>1.70</td></tr> <tr><td>5h'08</td><td>1.15</td><td>5h'14</td><td>1.80</td></tr> <tr><td>5h'09</td><td>1.20</td><td>5h'15</td><td>1.90</td></tr> <tr><td>5h'0A</td><td>1.25</td><td>5h'16</td><td>2.50</td></tr> <tr><td>5h'0B</td><td>1.30</td><td>5h'17</td><td>2.80</td></tr> <tr><td>5h'0C</td><td>1.35</td><td>5h'18</td><td>3.00</td></tr> <tr><td></td><td></td><td>5h'19</td><td>3.30</td></tr> </tbody> </table> | Data Code | (V) | Data Code | (V) | 5h'01 | 0.80 | 5h'0D | 1.40 | 5h'02 | 0.85 | 5h'0E | 1.45 | 5h'03 | 0.90 | 5h'0F | 1.50 | 5h'04 | 0.95 | 5h'10 | 1.55 | 5h'05 | 1.00 | 5h'11 | 1.60 | 5h'06 | 1.05 | 5h'12 | 1.65 | 5h'07 | 1.10 | 5h'13 | 1.70 | 5h'08 | 1.15 | 5h'14 | 1.80 | 5h'09 | 1.20 | 5h'15 | 1.90 | 5h'0A | 1.25 | 5h'16 | 2.50 | 5h'0B | 1.30 | 5h'17 | 2.80 | 5h'0C | 1.35 | 5h'18 | 3.00 | | | 5h'19 | 3.30 |
| Data Code | (V) | Data Code | (V) | | | | | | | | | | | | | | | | | | | | | | | | | | | | | | | | | | | | | | | | | | | | | | | | | | | | | | | | |
| 5h'01 | 0.80 | 5h'0D | 1.40 | | | | | | | | | | | | | | | | | | | | | | | | | | | | | | | | | | | | | | | | | | | | | | | | | | | | | | | | |
| 5h'02 | 0.85 | 5h'0E | 1.45 | | | | | | | | | | | | | | | | | | | | | | | | | | | | | | | | | | | | | | | | | | | | | | | | | | | | | | | | |
| 5h'03 | 0.90 | 5h'0F | 1.50 | | | | | | | | | | | | | | | | | | | | | | | | | | | | | | | | | | | | | | | | | | | | | | | | | | | | | | | | |
| 5h'04 | 0.95 | 5h'10 | 1.55 | | | | | | | | | | | | | | | | | | | | | | | | | | | | | | | | | | | | | | | | | | | | | | | | | | | | | | | | |
| 5h'05 | 1.00 | 5h'11 | 1.60 | | | | | | | | | | | | | | | | | | | | | | | | | | | | | | | | | | | | | | | | | | | | | | | | | | | | | | | | |
| 5h'06 | 1.05 | 5h'12 | 1.65 | | | | | | | | | | | | | | | | | | | | | | | | | | | | | | | | | | | | | | | | | | | | | | | | | | | | | | | | |
| 5h'07 | 1.10 | 5h'13 | 1.70 | | | | | | | | | | | | | | | | | | | | | | | | | | | | | | | | | | | | | | | | | | | | | | | | | | | | | | | | |
| 5h'08 | 1.15 | 5h'14 | 1.80 | | | | | | | | | | | | | | | | | | | | | | | | | | | | | | | | | | | | | | | | | | | | | | | | | | | | | | | | |
| 5h'09 | 1.20 | 5h'15 | 1.90 | | | | | | | | | | | | | | | | | | | | | | | | | | | | | | | | | | | | | | | | | | | | | | | | | | | | | | | | |
| 5h'0A | 1.25 | 5h'16 | 2.50 | | | | | | | | | | | | | | | | | | | | | | | | | | | | | | | | | | | | | | | | | | | | | | | | | | | | | | | | |
| 5h'0B | 1.30 | 5h'17 | 2.80 | | | | | | | | | | | | | | | | | | | | | | | | | | | | | | | | | | | | | | | | | | | | | | | | | | | | | | | | |
| 5h'0C | 1.35 | 5h'18 | 3.00 | | | | | | | | | | | | | | | | | | | | | | | | | | | | | | | | | | | | | | | | | | | | | | | | | | | | | | | | |
| | | 5h'19 | 3.30 | | | | | | | | | | | | | | | | | | | | | | | | | | | | | | | | | | | | | | | | | | | | | | | | | | | | | | | | |

BUCK 3 TARGET VOLTAGE REGISTER (B3TV) 8H'86

| Bit | 7 | 6 | 5 | 4** | 3** | 2** | 1** | 0** |
|-------------|----------|---|---|------------------------------|-----|-----|-----|-----|
| Designation | Reserved | | | Buck 3 Output Voltage (B3OV) | | | | |
| Reset Value | 0 | 0 | 0 | 1 | 0 | 1 | 0 | 0 |

Note: ** denotes one time factory programmable EPROM registers for default values

BUCK 3 TARGET VOLTAGE REGISTER (B3TV) 8H'86 DEFINITIONS

| Bit | Access | Name | Description | | | | | | | | | | | | | | | | | | | | | | | | | | | | | | | | | | | | | | | | | | | | | | | | | | | | |
|-----------|--------|--------------|--|-----------|-----|-----------|-----|-------|------|-------|------|-------|------|-------|------|-------|------|-------|------|-------|------|-------|------|-------|------|-------|------|-------|------|-------|------|-------|------|--------------|-------------|-------|------|-------|------|-------|------|-------|------|-------|------|-------|------|-------|------|-------|------|-------|------|-------|------|
| 7:5 | — | | Reserved | | | | | | | | | | | | | | | | | | | | | | | | | | | | | | | | | | | | | | | | | | | | | | | | | | | | |
| 4:0 | R/W | B3OV | Output Voltage | | | | | | | | | | | | | | | | | | | | | | | | | | | | | | | | | | | | | | | | | | | | | | | | | | | | |
| | | | <table border="1"> <thead> <tr> <th>Data Code</th> <th>(V)</th> <th>Data Code</th> <th>(V)</th> </tr> </thead> <tbody> <tr><td>5h'01</td><td>0.80</td><td>5h'0D</td><td>1.40</td></tr> <tr><td>5h'02</td><td>0.85</td><td>5h'0E</td><td>1.45</td></tr> <tr><td>5h'03</td><td>0.90</td><td>5h'0F</td><td>1.50</td></tr> <tr><td>5h'04</td><td>0.95</td><td>5h'11</td><td>1.60</td></tr> <tr><td>5h'05</td><td>1.00</td><td>5h'12</td><td>1.65</td></tr> <tr><td>5h'06</td><td>1.05</td><td>5h'13</td><td>1.70</td></tr> <tr><td>5h'07</td><td>1.10</td><td>5h'14</td><td>1.80</td></tr> <tr><td>5h'08</td><td>1.15</td><td>5h'15</td><td>1.90</td></tr> <tr><td>5h'09</td><td>1.20</td><td>5h'16</td><td>2.50</td></tr> <tr><td>5h'0A</td><td>1.25</td><td>5h'17</td><td>2.80</td></tr> <tr><td>5h'0B</td><td>1.30</td><td>5h'18</td><td>3.00</td></tr> <tr><td>5h'0C</td><td>1.35</td><td>5h'19</td><td>3.30</td></tr> </tbody> </table> | Data Code | (V) | Data Code | (V) | 5h'01 | 0.80 | 5h'0D | 1.40 | 5h'02 | 0.85 | 5h'0E | 1.45 | 5h'03 | 0.90 | 5h'0F | 1.50 | 5h'04 | 0.95 | 5h'11 | 1.60 | 5h'05 | 1.00 | 5h'12 | 1.65 | 5h'06 | 1.05 | 5h'13 | 1.70 | 5h'07 | 1.10 | 5h'14 | 1.80 | 5h'08 | 1.15 | 5h'15 | 1.90 | 5h'09 | 1.20 | 5h'16 | 2.50 | 5h'0A | 1.25 | 5h'17 | 2.80 | 5h'0B | 1.30 | 5h'18 | 3.00 | 5h'0C | 1.35 | 5h'19 | 3.30 |
| Data Code | (V) | Data Code | (V) | | | | | | | | | | | | | | | | | | | | | | | | | | | | | | | | | | | | | | | | | | | | | | | | | | | | |
| 5h'01 | 0.80 | 5h'0D | 1.40 | | | | | | | | | | | | | | | | | | | | | | | | | | | | | | | | | | | | | | | | | | | | | | | | | | | | |
| 5h'02 | 0.85 | 5h'0E | 1.45 | | | | | | | | | | | | | | | | | | | | | | | | | | | | | | | | | | | | | | | | | | | | | | | | | | | | |
| 5h'03 | 0.90 | 5h'0F | 1.50 | | | | | | | | | | | | | | | | | | | | | | | | | | | | | | | | | | | | | | | | | | | | | | | | | | | | |
| 5h'04 | 0.95 | 5h'11 | 1.60 | | | | | | | | | | | | | | | | | | | | | | | | | | | | | | | | | | | | | | | | | | | | | | | | | | | | |
| 5h'05 | 1.00 | 5h'12 | 1.65 | | | | | | | | | | | | | | | | | | | | | | | | | | | | | | | | | | | | | | | | | | | | | | | | | | | | |
| 5h'06 | 1.05 | 5h'13 | 1.70 | | | | | | | | | | | | | | | | | | | | | | | | | | | | | | | | | | | | | | | | | | | | | | | | | | | | |
| 5h'07 | 1.10 | 5h'14 | 1.80 | | | | | | | | | | | | | | | | | | | | | | | | | | | | | | | | | | | | | | | | | | | | | | | | | | | | |
| 5h'08 | 1.15 | 5h'15 | 1.90 | | | | | | | | | | | | | | | | | | | | | | | | | | | | | | | | | | | | | | | | | | | | | | | | | | | | |
| 5h'09 | 1.20 | 5h'16 | 2.50 | | | | | | | | | | | | | | | | | | | | | | | | | | | | | | | | | | | | | | | | | | | | | | | | | | | | |
| 5h'0A | 1.25 | 5h'17 | 2.80 | | | | | | | | | | | | | | | | | | | | | | | | | | | | | | | | | | | | | | | | | | | | | | | | | | | | |
| 5h'0B | 1.30 | 5h'18 | 3.00 | | | | | | | | | | | | | | | | | | | | | | | | | | | | | | | | | | | | | | | | | | | | | | | | | | | | |
| 5h'0C | 1.35 | 5h'19 | 3.30 | | | | | | | | | | | | | | | | | | | | | | | | | | | | | | | | | | | | | | | | | | | | | | | | | | | | |
| | | | Default | | | | | | | | | | | | | | | | | | | | | | | | | | | | | | | | | | | | | | | | | | | | | | | | | | | | |

V_{CC} BUCK 3:2 VOLTAGE RAMP CONTROL REGISTER (B32RC)V_{CC} Buck 3:2 Voltage Ramp Control Register (B32RC) 8h'87

| Bit | 7 | 6 | 5 | 4 | 3 | 2 | 1 | 0 |
|-------------|------------------|---|---|---|------------------|---|---|---|
| Designation | Ramp Rate (B3RR) | | | | Ramp Rate (B2RR) | | | |
| Reset Value | 1 | 0 | 1 | 0 | 1 | 0 | 1 | 0 |

Buck 3:2 Voltage Ramp Control Register (B3RC) 8h'87 Definitions

| Bit | Access | Name | Description | |
|------|--------|------|------------------|------------------------|
| 7:4 | R/W | B3RR | Data Code | Ramp Rate mV/μS |
| | | | 4h'0 | Instant |
| | | | 4h'1 | 1 |
| | | | 4h'2 | 2 |
| | | | 4h'3 | 3 |
| | | | 4h'4 | 4 |
| | | | 4h'5 | 5 |
| | | | 4h'6 | 6 |
| | | | 4h'7 | 7 |
| | | | 4h'8 | 8 |
| | | | 4h'9 | 9 |
| 4h'A | 10 | | | |
| 3:0 | R/W | B2RR | Data Code | Ramp Rate mV/μS |
| | | | 4h'0 | Instant |
| | | | 4h'1 | 1 |
| | | | 4h'2 | 2 |
| | | | 4h'3 | 3 |
| | | | 4h'4 | 4 |
| | | | 4h'5 | 5 |
| | | | 4h'6 | 6 |
| | | | 4h'7 | 7 |
| | | | 4h'8 | 8 |
| | | | 4h'9 | 9 |
| 4h'A | 10 | | | |

INTERRUPT STATUS REGISTER ISRA

[查询"LP3972SQ-A514"供应商](#)

This register specifies the status bits for the interrupts generated by the PMIC. Thermal warning of the IC, GPIO1, GPIO2, PWR_ON pin, TEST_JIG factory programmable on signal, and the SPARE pin.

Interrupt Status Register ISRA 8h'88

| Bit | 7 | 6 | 5 | 4 | 3 | 2 | 1 | 0 |
|-------------|----------|------|------|------|------|------|------|------|
| Designation | Reserved | T125 | GPI2 | GPI1 | WUP3 | WUP2 | WUPT | WUPS |
| Reset Value | 0 | 0 | 0 | 0 | 0 | 0 | 0 | 0 |

Interrupt Status Register ISRA 8h'88 Definitions

| Bit | Access | Name | Description |
|-----|--------|------|---|
| 7 | — | — | Reserved |
| 6 | R | T125 | Status bit for thermal warning PMIC T>125C 0 = PMIC Temp. < 125°C 1 = PMIC Temp. > 125°C |
| 5 | R | GPI2 | Status bit for the input read in from GPIO 2 when set as Input 0 = GPI2 Logic Low 1 = GPI2 Logic High |
| 4 | R | GPI1 | Status bit for the input read in from GPIO 1 when set as Input 0 = GPI1 Logic Low 1 = GPI1 Logic High |
| 3 | R | WUP3 | PWR_ON Pin long pulse Wake Up Status 0 = No wake up event 1 = Long pulse wake up event |
| 2 | R | WUP2 | PWR_ON Pin Short pulse Wake Up Status 0 = No wake up event 1 = Short pulse wake up event |
| 1 | R | WUPT | TEST_JIG Pin Wake Up Status 0 = No wake up event 1 = Wake up event |
| 0 | R | WUPS | SPARE Pin Wake Up Status 0 = No wake up event 1 = Wake up event |

BACKUP BATTERY CHARGER CONTROL REGISTER (BCCR)

This register specifies the status of the main battery supply. NBUB bit

Backup Battery Charger Control Register (BCCR) 8h'89

| Bit | 7** | 6 | 5** | 4** | 3** | 2 | 1 | 0 |
|-------------|------|-------|-------|-----|-----|-------|------|---|
| Designation | NBUB | CNBFL | nBFLT | | | BUCEN | IBUC | |
| Reset Value | 0 | 0 | 0 | 1 | 0 | 0 | 0 | 1 |

Note: ** denotes one time factory programmable EPROM registers for default values

Backup Battery Charger Control Register (BCCR) 8h'89 Definitions

| Bit | Access | Name | Description | | | |
|-------|--------|-------|--|--------------------------|--------------------|------------------|
| 7 | R/W | NBUB | No back-up battery default setting. Logic will not allow switch over to back-up battery. 0 = Back up Battery Enabled, Default 1 = Back up Battery Disabled | | | |
| 6 | R/W | CNBFL | Control for nBATT_FLT output signal 0 = nBATT_FLT Enabled 1 = nBATT_FLT Disabled | | | |
| 5:3 | R/W | BFLT | nBATT_FLT monitors the battery voltage and can be set to the Assert voltages listed below. | | | |
| | | | Data Code | Asserted | De-Asserted | Note: Default |
| | | | 3h'01 | 2.6 | 2.8 | |
| | | | 3h'02 | 2.8 | 3.0 | |
| | | | 3h'03 | 3.0 | 3.2 | |
| | | | 3h'04 | 3.2 | 3.4 | |
| 3h'05 | 3.4 | 3.6 | | | | |
| 2 | R/W | BUCEN | Enables backup battery charger 0 = Back up Battery Charger Disabled 1 = Back up Battery Charger Enabled | | | |
| 1:0 | R/W | IBUC | Charger current setting for back-up battery | | | |
| | | | Data Code | BU Charger I (µA) | | Note: Default |
| | | | 2h'00 | 260 | | |
| | | | 2h'01 | 190 | | |
| | | | 2h'02 | 325 | | |
| 2h'03 | 390 | | | | | |

MARVELL PXA INTERNAL 1 REVISION REGISTER (II1RR) 8H'8E

查询"LP3972SQ-A514"供应商

| Bit | 7 | 6 | 5 | 4 | 3 | 2 | 1 | 0 |
|-------------|-------|---|---|---|---|---|---|---|
| Designation | II1RR | | | | | | | |
| Reset Value | 0 | 0 | 0 | 0 | 0 | 0 | 0 | 0 |

MARVELL PXA INTERNAL 1 REVISION REGISTER (II1RR) 8H'8E DEFINITIONS

| Bit | Access | Name | Description |
|-----|--------|-------|---|
| 7:0 | R | II1RR | Intel internal usage register for revision information. |

MARVELL PXA INTERNAL 2 REVISION REGISTER (II2RR) 8H'8F

| Bit | 7 | 6 | 5 | 4 | 3 | 2 | 1 | 0 |
|-------------|-------|---|---|---|---|---|---|---|
| Designation | II2RR | | | | | | | |
| Reset Value | 0 | 0 | 0 | 0 | 0 | 0 | 0 | 0 |

MARVELL PXA INTERNAL 2 REVISION REGISTER (II2RR) 8H'8F DEFINITIONS

| Bit | Access | Name | Description |
|-----|--------|-------|---|
| 7:0 | R | II2RR | Intel internal usage register for revision information. |

REGISTER PROGRAMMING EXAMPLES

Example 1) Start of Day Sequence

| PMIC Register Address | PMIC Register Name | Register Data | Description |
|-----------------------|--------------------|---------------|---|
| 8h'23 | ADTVI | 00011011 | Sets the SOD V _{CC-APPS} voltage |
| 8h'29 | SDTV1 | 00011011 | Sets the SOD V _{CC-SRAM} voltage |
| 8h'10 | OVER1 | 00000111 | Enables V _{CC-SRAM} and V _{CC-APPS} to their programmed values. |

SODI Multi-byte random register transfer is outlined below:

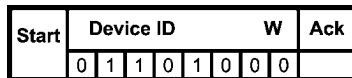

ADTV1 (8h'23)

Register Data (00011011)

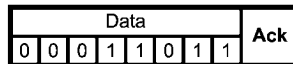
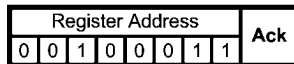

SDTV1 (8h'29)

Register Data (00011011)

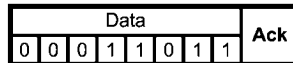
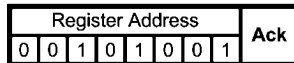

OVER1 (8h'10)

Register Data (00000111)

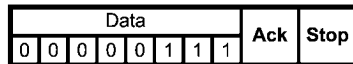
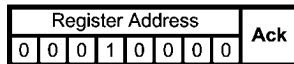

20207644

Device Address, Register A Address, Ach,
[查询"LP3972SG-A014"供应商](#)
 Register M Address, Ach,
 Register M Data, Ach
 Register X Address, Ach,
 Register X Data, Ach
 Register Z Address, Ach,
 Register Z Data, Ach, Stop

Example 2) Voltage change Sequence

| PMIC Register Address | PMIC Register Name | Register Data | Description |
|-----------------------|--------------------|---------------|---|
| 8h'24 | ADTV2 | 00010111 | Sets the V _{CC} _APPS target voltage 2 to 1.3 V |
| 8h'2A | SDTV2 | 00001111 | Sets the V _{CC} _SRAM target voltage 2 to 1.1 V |
| 8h'20 | V _{CC} 1 | 00110011 | Enable V _{CC} _SRAM and V _{CC} _APPS to change to their programmed target values. |

I²C DATA EXCHANGE BETWEEN MASTER AND SLAVE DEVICE

| | | | |
|-------|-----------------|---|-----|
| Start | Device ID | W | Ack |
| | 0 1 1 0 1 0 0 0 | | |

ADTV2 (8h'24)

| | |
|------------------|-----|
| Register Address | Ack |
| 0 0 1 0 0 1 0 0 | |

Register Data (00010111)

| | |
|-----------------|-----|
| Data | Ack |
| 0 0 0 1 0 1 1 1 | |

SDTV2 (8h'2A)

| | |
|------------------|-----|
| Register Address | Ack |
| 0 0 1 0 1 0 1 0 | |

Register Data (00001111)

| | |
|-----------------|-----|
| Data | Ack |
| 0 0 0 0 1 1 1 1 | |

VCC1 (8h'20)

| | |
|------------------|-----|
| Register Address | Ack |
| 0 0 1 0 0 0 0 0 | |

Register Data (00110011)

| | | |
|-----------------|-----|------|
| Data | Ack | Stop |
| 0 0 1 1 0 0 1 1 | | |

20207645

LP3972 Controls

[查询"LP3972SQ-A514"供应商](#)

DIGITAL INTERFACE CONTROL SIGNALS

| Signal | Definition | Active State | Signal Direction |
|-----------------|--|--------------|----------------------|
| SYS_EN | High Voltage Power Enable | High | Input |
| PWR_EN | Low Voltage Power Enable | High | Input |
| SCL | Serial Bus Clock Line | Clock | Input |
| SDA | Serial Bus Data Line | | Bidirectional |
| nRSTI | Forces an unconditional hardware reset | Low | Input |
| nRSTO | Forces an unconditional hardware reset | Low | Output |
| nBATT_FLT | Main Battery removed or discharged indicator | Low | Output |
| PWR_ON | Wakeup Input to CPU | High | Input |
| nTEST_JIG | Wakeup Input to CPU | Low | Input |
| SPARE | Wakeup Input to CPU | High/Low | Input |
| EXT_WAKEUP | Wake-Up Output for application processor | High | Output |
| GPIO1 / nCHG_EN | General Purpose I/O /External Back-up Battery Charger enable | — | Bidirectional /Input |
| GPIO2 | General Purpose I/O | — | Bidirectional |

POWER DOMAIN ENABLES

| PMU Output | HW Enable | SW Enable |
|------------------------------|-----------|-----------|
| LDO_RTC | — | — |
| LDO 1 (V _{CC} _MVT) | SYS_EN | LDO1_EN |
| LDO2 | SYS_EN | LDO2_EN |
| LDO3 | SYS_EN | LDO3_EN |
| LDO4 | SYS_EN | LDO4_EN |

POWER DOMAINS SEQUENCING (DELAY)

By default SYS_EN must be on to have PWR_EN enable but this feature can be switched off by register bit BP_SYS.

By default SYS_EN enables LDO1 always first and after a typical of 1 ms delay others. Also when SYS_EN is set off the LDO1 will go off last. This function can be switched off or delay can be changed by DELAY bits via serial interface as seen on table below.

8h'80 Bit 5:4

| DELAY bits | '00' | '01' | '10' | '11' |
|------------|------|------|------|------|
| Delay, ms | 0 | 0.5 | 1.0 | 1.5 |

| PMU Output | HW Enable | SW Enable |
|-------------------------------|-----------|-----------|
| LDO5 (V _{CC} _SRAM) | PWR_EN | S_EN |
| Buck1 (V _{CC} _APPS) | PWR_EN | A_EN |
| BUCK2 | SYS_EN | B2_EN |
| BUCK3 | SYS_EN | B3_EN |

LDO_RTC TRACKING (nIO_TRACK)

LP3972 has a tracking function (nIO_TRACK). When enabled, LDO_RTC voltage will track LDO3 voltage within 200 mV down to 2.8V when LDO3 is enabled. This function can be switched on/off by nIO_TRACK register bit BPTR.

POWER SUPPLY ENABLE

SYS_EN and PWR_EN can be changed by programmable register bits.

WAKE-UP FUNCTIONALITY (PWR_ON, nTEST_JIG, SPARE AND EXT_WAKEUP)

Three input pins can be used to assert wakeup output for 10 ms for application processor notification to wakeup. SPARE Input can be programmed through I²C compatible interface to be active low or high (SPARE bit, Default is active low '1'). A reason for wakeup event can be read through I²C compatible interface also. Additionally wakeup inputs have 30 ms debounce filtering. Furthermore PWR_ON have distinguishing between short and long (~1s) pulses (push button input). LP3972 also has an internal Thermal Shutdown early warning that generates a wakeup to the system also. This is generated usually at 125°C.

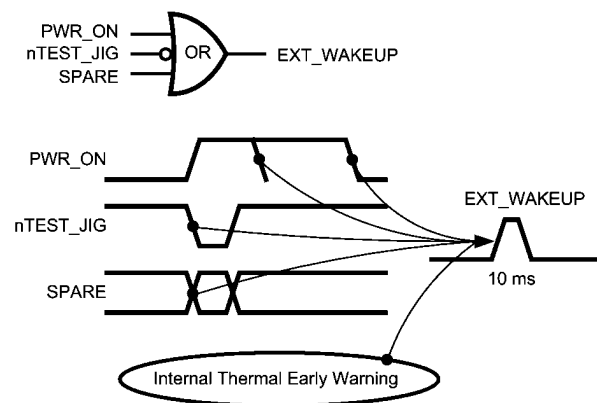

20207619

| WAKEUP register bits | Reason for WAKEUP |
|----------------------|--------------------|
| WUP0 | SPARE |
| WUP1 | TEST_JIG |
| WUP2 | PWR_ON short pulse |
| WUP3 | PWR_ON long pulse |
| TSD_EW | TSD Early Warning |

INTERNAL THERMAL SHUTDOWN PROCEDURE

Thermal shutdown is build to generate early warning (typ. 125°C) which triggers the EXT_WAKEUP for the processor acknowledge. When a thermal shutdown triggers (typ. 160°C) the PMU will reset the system until the device cools down.

BATTERY SWITCH AND BACK UP BATTERY CHARGER

When Back-Up battery is connected but the main battery has been removed or its supply voltage too low, LP3972 uses Back-Up Battery for generating LDO_RTC voltage. When Main Battery is available the battery fet switches over to the main battery for LDO_RTC voltage. When Main battery voltage is too low or removed nBATT_FLT is asserted. If no back up battery exists, the battery switch to back up can be switched off by nBU_BAT_EN bit. User can set the battery fault determination voltage and battery charger current via I²C compatible interface. Enabling of back up battery charger can be done via serial interface (nBAT_CHG_EN) or external charger enable pin (nCHG_EN). Pin 29 is set as external charger enable input by default.

GENERAL PURPOSE I/O FUNCTIONALITY (GPIO1 AND GPIO2)

查询"LP3972SQ-A514"供应商

LP3972 has 2 general purpose I/Os for system control. I²C compatible interface will be used for setting any of the pins to

input, output or hi-Z mode. Inputs value can be read via serial interface (GPIO1,2 bits). The pin 29 functionality needs to be set to GPIO by serial interface register bit nEXTCHGEN. (GPIO/CHG)

| Controls | | | | Port Function | Reg | batmonchg |
|----------|---------|---------------|-------|---------------|--------|-------------|
| GPIO<1> | GPIO<1> | Nextchgen_sel | bucen | GPIO1 | Gpin 1 | Function |
| X | X | 1 | 0 | Input = 0 | 0 | Enabled |
| X | X | 1 | 0 | Input = 1 | 0 | Not Enabled |
| 1 | 0 | 1 | X | X | 0 | |
| X | X | X | 1 | X | | Enabled |
| 0 | 0 | 0 | X | HiZ | | |
| 1 | 0 | 0 | X | Input (dig)-> | Input | |
| 0 | 1 | 0 | X | Output = 0 | 0 | |
| 1 | 1 | 0 | X | Output = 1 | 0 | |

| GPIO<1> | GPIO<1> | Factory fm disabled | GPIO_tstiob | GPIO2 | gpin2 |
|---------|---------|---------------------|-------------|---------------|-------|
| 0 | 0 | | 1 | HiZ | 0 |
| 1 | 0 | | 1 | Input (dig)-> | input |
| 0 | 1 | | 1 | Output = 0 | 0 |
| 1 | 1 | | 1 | Output = 1 | 0 |

The LP3972 has provision for two battery connections, the main battery Vbat and Backup Battery (See Applications Schematic Diagrams 1 & 2 of the LP3972 Data Sheet).

The function of the battery switch is to connect power to the RTC LDO from the appropriate battery, depending on conditions described below:

- If only the backup battery is applied, the switch will automatically connect the RTC LDO power to this battery.
- If only the main battery is applied, the switch will automatically connect the RTC LDO power to this battery.
- If both batteries are applied, and the main battery is sufficiently charged ($V_{BAT} > 3.1V$), the switch will automatically connect the RTC LDO power to the main battery.
- As the main battery is discharged by use, the user will be warned by a separate circuit called nBATT_FLT. Then if no action is taken to restore the charge on the main battery, and discharging is continued the battery switch will protect the RTC LDO by disconnecting from the main battery and connecting to the backup battery.

- The main battery voltage at which the RTC LDO is switched from main to backup battery is 2.9V typically.
- There is a hysteresis voltage in this switch operation so, the RTC LDO will not be reconnected to main battery until main battery voltage is greater than 3.1V typically.

- Additionally, the user may wish to disable the battery switch, such as, in the case when only a main battery is used. This is accomplished by setting the "no back up battery bit" in the control register 8h'89 bit 7 NBUB. With this bit set to "1", the above described switching will not occur, that is the RTC LDO will remain connected to the main battery even as it is discharged below the 2.9 Volt threshold.

REGULATED VOLTAGES OK

All the power domains have own register bit (X_OK) that processor can read via serial interface to be sure that enabled powers are OK (regulating). Note that these read only bits are only valid when regulators are settled (avoid reading these bits during voltage change or power up).

THERMAL MANAGEMENT

Applications: The LP3972 mode with 11 comparators (flags) can be turned on via the "enallflags" control register bit. This mode allows the user to interrogate the device or system temperature under the set operating conditions. Thus, the rate of temperature change can also be estimated. The system may then negotiate for speed and power trade off, or deploy cooling maneuvers to optimize system performance. The "enallflags" bit needs enabled only when the "bct<2:0>" bits are read to conserve power.

Note: The thermal management flags have been verified functional. Presently these registers are accessible by factory only. If there is a demand for this function, the relevant register controls may be shifted into the user programmable bank; the

temperature range and resolution of these flags, might also be refined/redefined.

THERMAL WARNING

2 of 6 low power comparators, each consumes less than 1 μA , are always enabled to operate the "T=125°C warning flag with hysteresis. This allows continuous monitoring of a thermal-warning flag feature with very low power consumption.

LP3972 THERMAL FLAGS FUNCTIONAL DIAGRAM, DATA FROM INITIAL SILICON

The following functions are extra features from the thermal shutdown circuit:

1) Thermal warning flag @ Temp $\sim > \sim 125^\circ\text{C}$ is issued at the wakeup port:

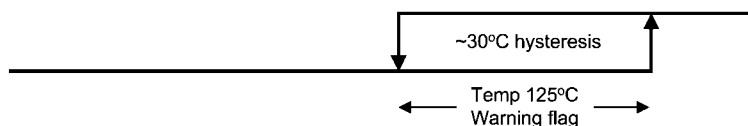

2) Binary coded thermal management flags in status registers, bct<2:0>:

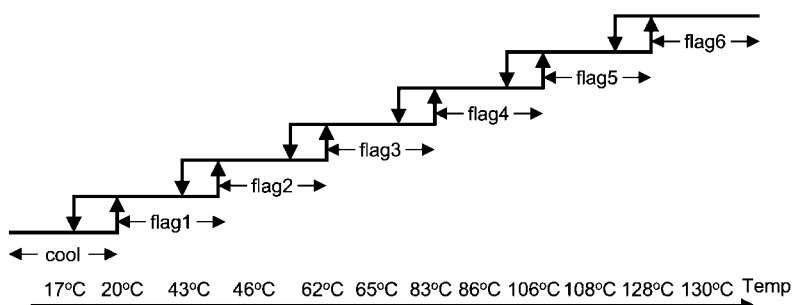

20207646

Application Note - LP3972 Reset Sequence

INITIAL COLD START POWER ON SEQUENCE

1. The Back up battery is connected to the PMU, power is applied to the back-up battery pin, the RTC_LDO turns on and supplies a stable output voltage to the V_{CC_BATT} pin of the Applications processor (initiating the power-on reset event) with $nRSTO$ asserted from the LP3972 to the processor.
2. $nRSTO$ de-asserts after a minimum of 50 mS.
3. The Applications processor waits for the de-assertion of $nBATT_FLT$ to indicate system power (V_{IN}) is available.
4. After system power (V_{IN}) is applied, the LP3972 de-asserts $nBATT_FLT$. Note that BOTH $nRSTO$ and $nBATT_FLT$ need to be de-asserted before SYS_EN is enabled. The sequence of the two signals is independent of each other.
5. The Applications processor asserts SYS_EN , the LP3972 enables the system high-voltage power supplies. The Applications processor starts its countdown timer set to 125 mS.
6. The LP3972 enables the high-voltage power supplies.
 - LDO1 power for V_{CC_MVT} (Power for internal logic and I/O Blocks), BG (Bandgap reference voltage), OSC13M (13 MHz oscillator voltage) and PLL enabled first, followed by others if delay is on.
7. Countdown timer expires; the Applications processor asserts PWR_EN to enable the low-voltage power supplies. The processor starts the countdown timer set to 125 mS period.
8. The Applications processor asserts PWR_EN (ext. pin or I²C), the LP3972 enables the low-voltage regulators.
9. Countdown timer expires; If enabled power domains are OK (I²C read) the power up sequence continues by enabling the processors 13 MHz oscillator and PLL's.
10. The Applications processor begins the execution of code.

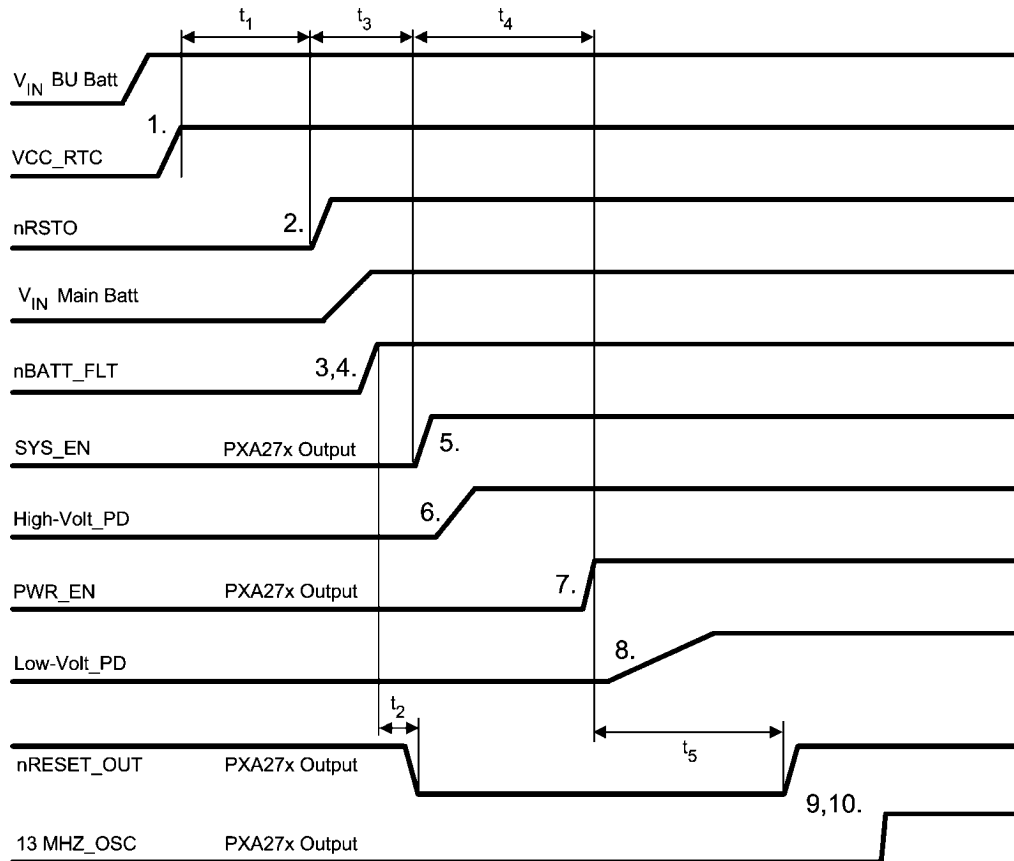

20207622

* Note that BOTH $nRSTO$ and $nBATT_FLT$ need to be de-asserted before SYS_EN is enabled. The sequence of the two signals is independent of each other and can occur in either order.

POWER-ON TIMING

查询"LP3972SQ-A514"供应商

| Symbol | Description | Min | Typ | Max | Units |
|--------|--|-----|-----|-----|-------|
| t1 | Delay from V _{CC_RTC} assertion to nRSTO de-assertion | 50 | | | mS |
| t2 | Delay from nBATT_FLT de-assertion to nRSTI assertion | | 100 | | μS |
| t3 | Delay from nRST de-assertion to SYS_EN assertion | | 10 | | mS |
| t4 | Delay from SYS_EN assertion to PWR_EN assertion | | 125 | | mS |
| t5 | Delay from PWR_EN assertion to nRSTO de-assertion | | 125 | | mS |

HARDWARE RESET SEQUENCE

Hardware reset initiates when the nRSTI signal is asserted (low). Upon assertion of nRST the processor enters hardware

RESET SEQUENCE

1. nRSTI is asserted.
 2. nRSTO is asserted and will de-asserts after a minimum of 50 mS
 3. The Applications processor waits for the de-assertion of nBATT_FLT to indicate system power (V_{IN}) is available.
 4. After system power (V_{IN}) is turned on, the LP3972 de-asserts nBATT_FLT.
 5. The Applications processor asserts SYS_EN, the LP3972 enables the system high-voltage power supplies. The Applications processor starts its countdown timer.
- reset state. The LP3972 holds the nRST low long enough (50 ms typ.) to allow the processor time to initiate the reset state.
6. The LP3972 enables the high-voltage power supplies.
 7. Countdown timer expires; the Applications processor asserts PWR_EN to enable the low-voltage power supplies. The processor starts the countdown timer.
 8. The Applications processor asserts PWR_EN, the LP3972 enables the low-voltage regulators.
 9. Countdown timer expires; If enabled power domains are OK (I²C read) the power up sequence continues by enabling the processors 13 MHz oscillator and PLL's.
 10. The Applications processor begins the execution of code.

Application Hints

查询"LP3972SQ-A514"供应商

LDO CONSIDERATIONS

External Capacitors

The LP3972's regulators require external capacitors for regulator stability. These are specifically designed for portable applications requiring minimum board space and smallest components. These capacitors must be correctly selected for good performance.

Input Capacitor

An input capacitor is required for stability. It is recommended that a 1.0 μF capacitor be connected between the LDO input pin and ground (this capacitance value may be increased without limit).

This capacitor must be located a distance of not more than 1 cm from the input pin and returned to a clean analogue ground. Any good quality ceramic, tantalum, or film capacitor may be used at the input.

Important: Tantalum capacitors can suffer catastrophic failures due to surge current when connected to a low impedance source of power (like a battery or a very large capacitor). If a tantalum capacitor is used at the input, it must be guaranteed by the manufacturer to have a surge current rating sufficient for the application.

There are no requirements for the ESR (Equivalent Series Resistance) on the input capacitor, but tolerance and temperature coefficient must be considered when selecting the capacitor to ensure the capacitance will remain approximately 1.0 μF over the entire operating temperature range.

Output Capacitor

The LDO's are designed specifically to work with very small ceramic output capacitors. A 1.0 μF ceramic capacitor (temperature types Z5U, Y5V or X7R) with ESR between 5 m Ω to 500 m Ω , are suitable in the application circuit.

For this device the output capacitor should be connected between the V_{OUT} pin and ground.

It is also possible to use tantalum or film capacitors at the device output, C_{OUT} (or V_{OUT}), but these are not as attractive for reasons of size and cost (see the section Capacitor Characteristics).

The output capacitor must meet the requirement for the minimum value of capacitance and also have an ESR value that is within the range 5 m Ω to 500 m Ω for stability.

No-Load Stability

The LDO's will remain stable and in regulation with no external load. This is an important consideration in some circuits, for example CMOS RAM keep-alive applications.

Capacitor Characteristics

The LDO's are designed to work with ceramic capacitors on the output to take advantage of the benefits they offer. For capacitance values in the range of 0.47 μF to 4.7 μF , ceramic capacitors are the smallest, least expensive and have the lowest ESR values, thus making them best for eliminating high frequency noise. The ESR of a typical 1.0 μF ceramic capacitor is in the range of 20 m Ω to 40 m Ω , which easily meets the ESR requirement for stability for the LDO's.

For both input and output capacitors, careful interpretation of the capacitor specification is required to ensure correct device operation. The capacitor value can change greatly, depending on the operating conditions and capacitor type. In particular, the output capacitor selection should take account of all

the capacitor parameters, to ensure that the specification is met within the application. The capacitance can vary with DC bias conditions as well as temperature and frequency of operation. Capacitor values will also show some decrease over time due to aging. The capacitor parameters are also dependant on the particular case size, with smaller sizes giving poorer performance figures in general. As an example, *Figure 4* shows a typical graph comparing different capacitor case sizes in a Capacitance vs. DC Bias plot. As shown in the graph, increasing the DC Bias condition can result in the capacitance value falling below the minimum value given in the recommended capacitor specifications table. Note that the graph shows the capacitance out of spec for the 0402 case size capacitor at higher bias voltages. It is therefore recommended that the capacitor manufacturers' specifications for the nominal value capacitor are consulted for all conditions, as some capacitor sizes (e.g. 0402) may not be suitable in the actual application.

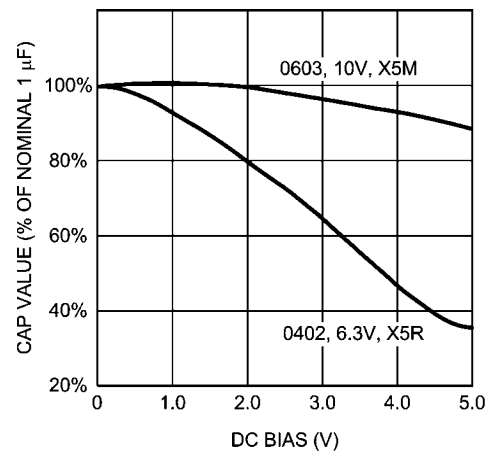

20207623

FIGURE 4. Graph Showing a Typical Variation in Capacitance vs. DC Bias

The ceramic capacitor's capacitance can vary with temperature. The capacitor type X7R, which operates over a temperature range of -55°C to $+125^{\circ}\text{C}$, will only vary the capacitance to within $\pm 15\%$. The capacitor type X5R has a similar tolerance over a reduced temperature range of -55°C to $+85^{\circ}\text{C}$. Many large value ceramic capacitors, larger than 1 μF are manufactured with Z5U or Y5V temperature characteristics. Their capacitance can drop by more than 50% as the temperature varies from 25°C to 85°C . Therefore X7R is recommended over Z5U and Y5V in applications where the ambient temperature will change significantly above or below 25°C .

Tantalum capacitors are less desirable than ceramic for use as output capacitors because they are more expensive when comparing equivalent capacitance and voltage ratings in the 0.47 μF to 4.7 μF range.

Another important consideration is that tantalum capacitors have higher ESR values than equivalent size ceramics. This means that while it may be possible to find a tantalum capacitor with an ESR value within the stable range, it would have to be larger in capacitance (which means bigger and more costly) than a ceramic capacitor with the same ESR value. It should also be noted that the ESR of a typical tantalum will increase about 2:1 as the temperature goes from 25°C down to -40°C , so some guard band must be allowed.

BUCK CONSIDERATIONS

Inductor Selection [查询"LP3972SQ-A514"供应商](#)

There are two main considerations when choosing an inductor; the inductor should not saturate, and the inductor current ripple is small enough to achieve the desired output voltage ripple. Different saturation current rating specs are followed by different manufacturers so attention must be given to details. Saturation current ratings are typically specified at 25°C so ratings at max ambient temperature of application should be requested from manufacturer.

There are two methods to choose the inductor saturation current rating.

Method 1

The saturation current is greater than the sum of the maximum load current and the worst case average to peak inductor current. This can be written as

$$I_{SAT} > I_{OUTMAX} + I_{RIPPLE}$$

$$\text{where } I_{RIPPLE} = \left(\frac{V_{IN} - V_{OUT}}{2 * L} \right) * \left(\frac{V_{OUT}}{V_{IN}} \right) * \left(\frac{1}{f} \right)$$

- I_{RIPPLE} : Average to peak inductor current
- I_{OUTMAX} : Maximum load current (1500 mA)
- V_{IN} : Maximum input voltage in application
- L: Min inductor value including worst case tolerances (30% drop can be considered for method 1)
- f: Minimum switching frequency (1.6 MHz)
- V_{OUT} : Output voltage

Method 2

A more conservative and recommended approach is to choose an inductor that has saturation current rating greater than the max current limit of TBD mA.

A 2.2 μ H inductor with a saturation current rating of at least TBD mA is recommended for most applications. The inductor's resistance should be less than 0.3 Ω for a good efficiency. *Table 1* lists suggested inductors and suppliers. For low-cost applications, an unshielded bobbin inductor could be considered. For noise critical applications, a toroidal or shielded bobbin inductor should be used. A good practice is to lay out the board with overlapping footprints of both types for design flexibility. This allows substitution of a low-noise shielded inductor, in the event that noise from low-cost bobbin models is unacceptable.

Input Capacitor Selection

A ceramic input capacitor of 10 μ F, 6.3V is sufficient for most applications. Place the input capacitor as close as possible to the V_{IN} pin of the device. A larger value may be used for improved input voltage filtering. Use X7R or X5R types, do not use Y5V. DC bias characteristics of ceramic capacitors must be considered when selecting case sizes like 0805 and 0603. The input filter capacitor supplies current to the PFET switch of the converter in the first half of each cycle and reduces voltage ripple imposed on the input power source. A ceramic capacitor's low ESR provides the best noise filtering of the input voltage spikes due to this rapidly changing current. Select a capacitor with sufficient ripple current rating. The input current ripple can be calculated as:

$$I_{RMS} = I_{OUTMAX} * \sqrt{\frac{V_{OUT}}{V_{IN}} * \left(1 - \frac{V_{OUT}}{V_{IN}} + \frac{r^2}{12} \right)}$$

$$\text{where } r = \frac{(V_{IN} - V_{OUT}) * V_{OUT}}{L * f * I_{OUTMAX} * V_{IN}}$$

The worst case is when $V_{IN} = 2 * V_{OUT}$

TABLE 1. Suggested Inductors and Their Suppliers

| Model | Vendor | Dimensions LxWxH (mm) | D.C.R (Typ) |
|---------------|-----------|-----------------------|----------------|
| FDSE0312-2R2M | Toko | 3.0 x 3.0 x 1.2 | 160 m Ω |
| DO1608C-222 | Coilcraft | 6.6 x 4.5 x 1.8 | 80 m Ω |

Output Capacitor Selection

Use a 10 μ F, 6.3V ceramic capacitor. Use X7R or X5R types, do not use Y5V. DC bias characteristics of ceramic capacitors must be considered when selecting case sizes like 0805 and 0603. DC bias characteristics vary from manufacturer to manufacturer and dc bias curves should be requested from them as part of the capacitor selection process. The output filter capacitor smooths out current flow from the inductor to the load, helps maintain a steady output voltage during transient load changes and reduces output voltage ripple. These capacitors must be selected with sufficient capacitance and sufficiently low ESR to perform these functions.

The output voltage ripple is caused by the charging and discharging of the output capacitor and also due to its ESR and can be calculated as:

$$V_{PP-C} = \frac{I_{RIPPLE}}{4 * f * C}$$

Voltage peak-to-peak ripple due to ESR can be expressed as follows

$$V_{PP-ESR} = (2 * I_{RIPPLE}) * R_{ESR}$$

Because these two components are out of phase the rms value can be used to get an approximate value of peak-to-peak ripple.

Voltage peak-to-peak ripple, root mean squared can be expressed as follows

$$V_{PP-RMS} = \sqrt{V_{PP-C}^2 + V_{PP-ESR}^2}$$

Note that the output voltage ripple is dependent on the inductor current ripple and the equivalent series resistance of the output capacitor (R_{ESR}).

The R_{ESR} is frequency dependent (as well as temperature dependent); make sure the value used for calculations is at the switching frequency of the part.

[查询"LP3972SQ-A514"供应商](#)

TABLE 2. Suggested Capacitor and Their Suppliers

| Model | Type | Vendor | Voltage | Case Size Inch (mm) |
|----------------|--------------|-------------|---------|------------------------|
| GRM21BR60J106K | Ceramic, X5R | Murata | 6.3V | 0805 (2012) |
| JMK212BJ106K | Ceramic, X5R | Taiyo-Yuden | 6.3V | 0805 (2012) |
| C2012X5R0J106K | Ceramic, X5R | TDK | 6.3V | 0805 (2012) |

Buck Output Ripple Management

If V_{IN} and I_{LOAD} increase, the output ripple associated with the Buck Regulators also increases. The figure below shows the safe operating area. To ensure operation in the area of concern it is recommended that the system designer circumvents the output ripple issues to install schottky diodes on the Bucks

(s) that are expected to perform under these extreme corner conditions.

(Schottky diodes are recommended to reduce the output ripple, if system requirements include this shaded area of operation. $V_{IN} > 1.5V$ and $I_{LOAD} > 1.24$)

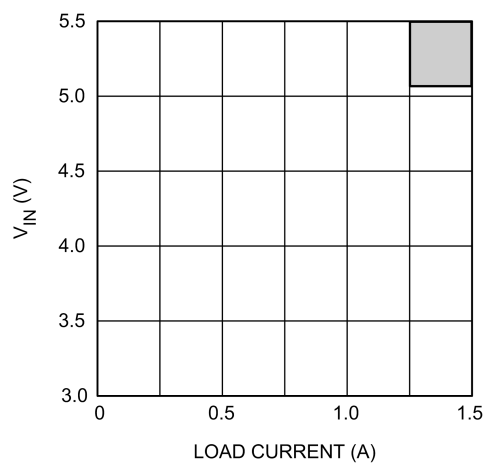

20207647

Board Layout Considerations

查询"LP3972SQ-A514"供应商

PC board layout is an important part of DC-DC converter design. Poor board layout can disrupt the performance of a DC-DC converter and surrounding circuitry by contributing to EMI, ground bounce, and resistive voltage loss in the traces. These can send erroneous signals to the DC-DC converter IC, resulting in poor regulation or instability.

Good layout for the converters can be implemented by following a few simple design rules.

1. Place the converters, inductor and filter capacitors close together and make the traces short. The traces between these components carry relatively high switching currents and act as antennas. Following this rule reduces radiated noise. Special care must be given to place the input filter capacitor very close to the V_{IN} and GND pin.
2. Arrange the components so that the switching current loops curl in the same direction. During the first half of each cycle, current flows from the input filter capacitor through the converter and inductor to the output filter capacitor and back through ground, forming a current loop. In the second half of each cycle, current is pulled up from ground through the converter by the inductor to the output filter capacitor and then back through ground forming a second current loop. Routing these loops so the current curls in the same direction prevents magnetic field reversal between the two half-cycles and reduces radiated noise.
3. Connect the ground pins of the converter and filter capacitors together using generous component-side copper fill as a pseudo-ground plane. Then, connect this to the ground-plane (if one is used) with several vias. This reduces ground-plane noise by preventing the switching currents from circulating through the ground plane. It also reduces ground bounce at the converter by giving it a low-impedance ground connection.
4. Use wide traces between the power components and for power connections to the DC-DC converter circuit. This reduces voltage errors caused by resistive losses across the traces.
5. Route noise sensitive traces, such as the voltage feedback path, away from noisy traces between the power components. The voltage feedback trace must remain close to the converter circuit and should be direct but should be routed opposite to noisy components. This reduces EMI radiated onto the DC-DC converter's own voltage feedback trace. A good approach is to route the feedback trace on another layer and to have a ground plane between the top layer and layer on which the feedback trace is routed. In the same manner for the adjustable part it is desired to have the feedback dividers on the bottom layer.
6. Place noise sensitive circuitry, such as radio RF blocks, away from the DC-DC converter, CMOS digital blocks and other noisy circuitry. Interference with noise-sensitive circuitry in the system can be reduced through distance.

Physical Dimensions inches (millimeters) unless otherwise noted

[查询"LP3972SQ-A514"供应商](#)

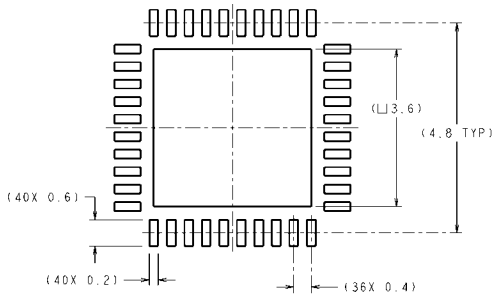

DIMENSIONS ARE IN MILLIMETERS
DIMENSIONS IN () FOR REFERENCE ONLY

RECOMMENDED LAND PATTERN

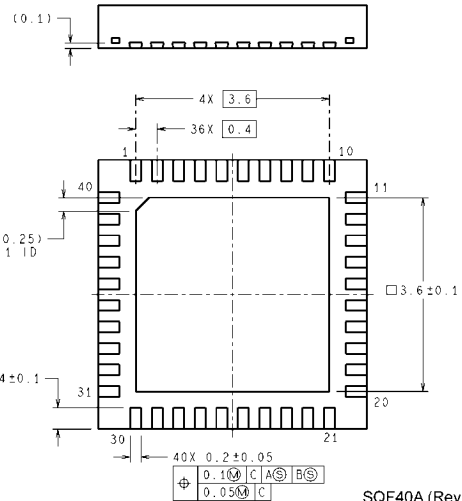
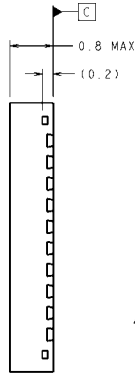
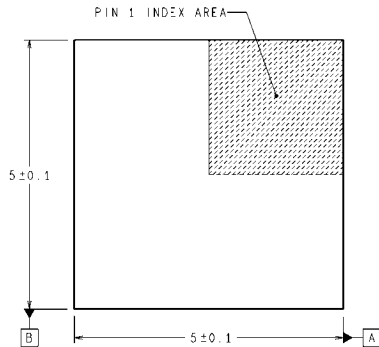

| | | | |
|-------|---|---|---|
| 0.10 | C | A | B |
| 0.050 | C | | |

SQF40A (Rev B)

**40-Pin Leadless Leadframe Package
NS Package Number SQF40A**

[查询"LP3972SQ-A514"供应商](#)

Notes

For more National Semiconductor product information and proven design tools, visit the following Web sites at:

| Products | | Design Support | |
|--------------------------------|--|-------------------------|--|
| Amplifiers | www.national.com/amplifiers | WEBENCH | www.national.com/webench |
| Audio | www.national.com/audio | Analog University | www.national.com/AU |
| Clock Conditioners | www.national.com/timing | App Notes | www.national.com/appnotes |
| Data Converters | www.national.com/adc | Distributors | www.national.com/contacts |
| Displays | www.national.com/displays | Green Compliance | www.national.com/quality/green |
| Ethernet | www.national.com/ethernet | Packaging | www.national.com/packaging |
| Interface | www.national.com/interface | Quality and Reliability | www.national.com/quality |
| LVDS | www.national.com/lvds | Reference Designs | www.national.com/refdesigns |
| Power Management | www.national.com/power | Feedback | www.national.com/feedback |
| Switching Regulators | www.national.com/switchers | | |
| LDOs | www.national.com/lido | | |
| LED Lighting | www.national.com/led | | |
| PowerWise | www.national.com/powerwise | | |
| Serial Digital Interface (SDI) | www.national.com/sdi | | |
| Temperature Sensors | www.national.com/tempsensors | | |
| Wireless (PLL/VCO) | www.national.com/wireless | | |

THE CONTENTS OF THIS DOCUMENT ARE PROVIDED IN CONNECTION WITH NATIONAL SEMICONDUCTOR CORPORATION ("NATIONAL") PRODUCTS. NATIONAL MAKES NO REPRESENTATIONS OR WARRANTIES WITH RESPECT TO THE ACCURACY OR COMPLETENESS OF THE CONTENTS OF THIS PUBLICATION AND RESERVES THE RIGHT TO MAKE CHANGES TO SPECIFICATIONS AND PRODUCT DESCRIPTIONS AT ANY TIME WITHOUT NOTICE. NO LICENSE, WHETHER EXPRESS, IMPLIED, ARISING BY ESTOPPEL OR OTHERWISE, TO ANY INTELLECTUAL PROPERTY RIGHTS IS GRANTED BY THIS DOCUMENT.

TESTING AND OTHER QUALITY CONTROLS ARE USED TO THE EXTENT NATIONAL DEEMS NECESSARY TO SUPPORT NATIONAL'S PRODUCT WARRANTY. EXCEPT WHERE MANDATED BY GOVERNMENT REQUIREMENTS, TESTING OF ALL PARAMETERS OF EACH PRODUCT IS NOT NECESSARILY PERFORMED. NATIONAL ASSUMES NO LIABILITY FOR APPLICATIONS ASSISTANCE OR BUYER PRODUCT DESIGN. BUYERS ARE RESPONSIBLE FOR THEIR PRODUCTS AND APPLICATIONS USING NATIONAL COMPONENTS. PRIOR TO USING OR DISTRIBUTING ANY PRODUCTS THAT INCLUDE NATIONAL COMPONENTS, BUYERS SHOULD PROVIDE ADEQUATE DESIGN, TESTING AND OPERATING SAFEGUARDS.

EXCEPT AS PROVIDED IN NATIONAL'S TERMS AND CONDITIONS OF SALE FOR SUCH PRODUCTS, NATIONAL ASSUMES NO LIABILITY WHATSOEVER, AND NATIONAL DISCLAIMS ANY EXPRESS OR IMPLIED WARRANTY RELATING TO THE SALE AND/OR USE OF NATIONAL PRODUCTS INCLUDING LIABILITY OR WARRANTIES RELATING TO FITNESS FOR A PARTICULAR PURPOSE, MERCHANTABILITY, OR INFRINGEMENT OF ANY PATENT, COPYRIGHT OR OTHER INTELLECTUAL PROPERTY RIGHT.

LIFE SUPPORT POLICY

NATIONAL'S PRODUCTS ARE NOT AUTHORIZED FOR USE AS CRITICAL COMPONENTS IN LIFE SUPPORT DEVICES OR SYSTEMS WITHOUT THE EXPRESS PRIOR WRITTEN APPROVAL OF THE CHIEF EXECUTIVE OFFICER AND GENERAL COUNSEL OF NATIONAL SEMICONDUCTOR CORPORATION. As used herein:

Life support devices or systems are devices which (a) are intended for surgical implant into the body, or (b) support or sustain life and whose failure to perform when properly used in accordance with instructions for use provided in the labeling can be reasonably expected to result in a significant injury to the user. A critical component is any component in a life support device or system whose failure to perform can be reasonably expected to cause the failure of the life support device or system or to affect its safety or effectiveness.

National Semiconductor and the National Semiconductor logo are registered trademarks of National Semiconductor Corporation. All other brand or product names may be trademarks or registered trademarks of their respective holders.

Copyright© 2008 National Semiconductor Corporation

For the most current product information visit us at www.national.com



**National Semiconductor
Americas Technical
Support Center**
Email:
new.feedback@nsc.com
Tel: 1-800-272-9959

**National Semiconductor Europe
Technical Support Center**
Email: europe.support@nsc.com
German Tel: +49 (0) 180 5010 771
English Tel: +44 (0) 870 850 4288

**National Semiconductor Asia
Pacific Technical Support Center**
Email: ap.support@nsc.com

**National Semiconductor Japan
Technical Support Center**
Email: jpn.feedback@nsc.com