

NX series Screw Terminal Type, High ripple longer life.

查询"LNx2G102MSEF"供应商

- Suited for use in industrial power supplies for inverter circuitry, etc.
- High ripple current, extra-high voltage application.
- High reliability, long life for 20,000 hours application of rated ripple current at +85°C.
- Extended range up to $\phi 100 \times 250L$ size.
- Flame retardant electrolyte type available.
- Bushing type for better vibration and insulation also available.
- Available for adapted to the RoHS directive (2002/95/EC).

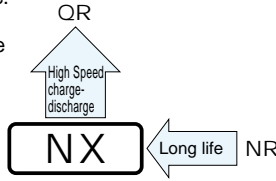
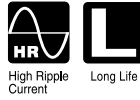

Specifications

Item	Performance Characteristics					
Category Temperature Range	-25 ~ +85°C					
Rated Voltage Range	350 ~ 630V					
Rated Capacitance Range	1000 ~ 27000 μ F					
Capacitance Tolerance	$\pm 20\%$ at 120Hz, 20°C					
Leakage Current	After 5 minutes' application of rated voltage, leakage current is not more than $3\sqrt{CV}$ (μ A) or 5 mA, whichever is smaller (at 20°C). [C: Rated Capacitance(μ F), V: Voltage (V)]					
tan δ	See P225 (Measurement frequency: 120Hz, Temperature: 20°C)					
Stability at Low Temperature	<table border="1"> <tr> <td>Rated voltage (V)</td> <td>350 ~ 630</td> <td rowspan="2">Measurement frequency: 120Hz</td> </tr> <tr> <td>Impedance ratio ZT/Z20(MAX.)</td> <td>Z - 25°C / Z + 20°C</td> </tr> </table>	Rated voltage (V)	350 ~ 630	Measurement frequency: 120Hz	Impedance ratio ZT/Z20(MAX.)	Z - 25°C / Z + 20°C
	Rated voltage (V)	350 ~ 630	Measurement frequency: 120Hz			
Impedance ratio ZT/Z20(MAX.)	Z - 25°C / Z + 20°C					
Endurance	After an application of DC voltage (in the range of rated voltage even after over-lapping the standard ripple current) for 20,000 hours at 85°C, capacitors shall meet the characteristics requirements indicated at right. (2000 hours at 85°C for the parts rated at 630V, 5000 hours at 85°C for the parts rated at 500V and 550V)					
	After an application of DC voltage (in the range of rated DC voltage even after over-lapping the maximum allowable ripple current) for 5000 hours at 85°C, capacitors meet the characteristic requirements listed at right.					
	<table border="1"> <tr> <td>Capacitance change</td> <td>Within $\pm 20\%$ of initial value</td> </tr> <tr> <td>tan δ</td> <td>300% or less of initial specified value</td> </tr> <tr> <td>Leakage current</td> <td>Initial specified value or less</td> </tr> </table>	Capacitance change	Within $\pm 20\%$ of initial value	tan δ	300% or less of initial specified value	Leakage current
Capacitance change	Within $\pm 20\%$ of initial value					
tan δ	300% or less of initial specified value					
Leakage current	Initial specified value or less					
Shelf Life	After storing the capacitors under no load at 85°C for 1000 hours, and after performing voltage treatment based on JIS C 5101-4 clause 4.1 at 20°C, they will meet the specified value for endurance characteristics listed above.					
Marking	Printed with white color letter on black sleeve.					

Drawing

Method mount metal bracket

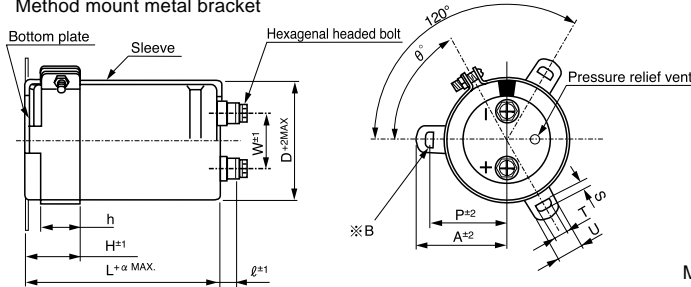

※ B
3-leg brackets for $\phi 90$ capacitors have different hole shapes from the ordinary ones illustrated below.

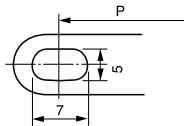

Method to mount resin bushing ($\phi 76.2$) (Apply to L=150 or more)

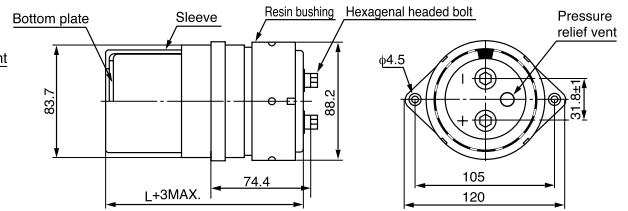

Method to mount resin bushing ($\phi 90$) (Apply to L=150 or more)

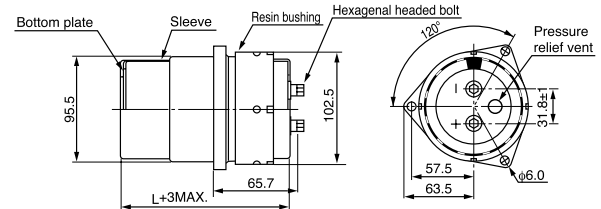

● Dimension of terminal pitch (W) and length (ℓ) and Nominal dia. of bolt (mm)

ϕD	W	ℓ	α	Nominal dia. of bolt
51	22.0	6	3	M5
63.5	28.6	6	3	M5
76.2	31.8	6	3	M5
90	31.8	6	3	M5
100	41.5	10	4	M8

● Dimensions of mounting bracket (mm)

Symbol	3-Leg					2-Leg				
	ϕD	51	63.5	76.2	90	100	51	63.5	76.2	90
P		32.5	38.1	44.5	50.8	56.3	33.2	40.5	46.5	53
A		38.5	43	49.2	58.5	62	40	46.5	53	59
T		7.5	8.0	7.0	8.0	8.0	6.0	7.0	6.0	6.0
S		5.0	5.0	5.0	5.0	5.0	4.5	4.5	4.5	4.5
U		12	14	14	18	16	14	14	14	14
θ°		60	60	60	60	60	30	30	30	30
H		20	25	30	35	36	25	35	35	35
h		15	20	24	25	30	15	20	20	20

Type numbering system (Example: 450V 2200 μ F)

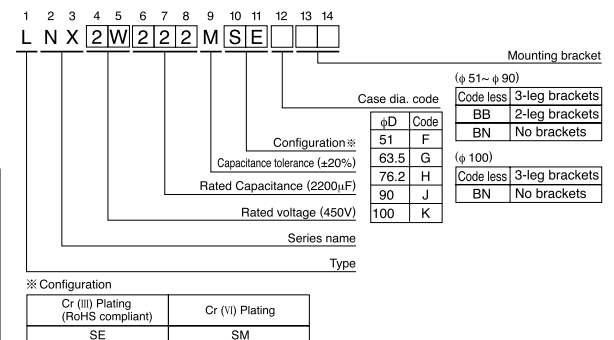

Resin bushing available upon request.

※ Please contact to us if PVC less products are required.

● Dimension table in next page.

NX series

查询"LNX2G102MSEF"供应商

■ Dimensions

V (Surge) (Code)	Cap.(μF)	Case size φ D×L(mm)	Standard ripple (Arms) ±1	Rated ripple (Arms) ±2	tan δ (MAX)	Leakage current (mA MAX) ±3	Code
350V (40V) (2V)	1000	51 × 60	3.5	4.6	0.2	1.77	LNX2V102MSEF
	1200	51 × 70	4.2	5.3	0.2	1.94	LNX2V122MSEF
	1500	51 × 80	4.9	6.3	0.2	2.17	LNX2V152MSEF
	1800	51 × 90	5.6	7.3	0.2	2.38	LNX2V182MSEF
	2200	51 × 110	6.7	8.8	0.2	2.63	LNX2V222MSEF
		51 × 130	8.0	10.3	0.2	2.92	LNX2V272MSEF
	2700	63.5 × 90	7.7	9.9	0.2	2.92	LNX2V272MSEG
		51 × 150	9.2	12.1	0.2	3.22	LNX2V332MSEF
	3300	63.5 × 100	9.0	11.8	0.2	3.22	LNX2V332MSEG
		63.5 × 110	10.4	12.5	0.2	3.50	LNX2V392MSEF
	3900	76.2 × 90	10.3	12.2	0.2	3.50	LNX2V392MSEH
		63.5 × 130	12.0	14.8	0.2	3.85	LNX2V472MSEG
	4700	76.2 × 100	11.9	14.0	0.2	3.85	LNX2V472MSEH
		63.5 × 150	14.0	17.0	0.2	4.20	LNX2V562MSEG
	5600	76.2 × 110	13.5	16.4	0.2	4.20	LNX2V562MSEH
		63.5 × 170	16.3	19.6	0.2	4.63	LNX2V682MSEG
	6800	76.2 × 130	16.0	19.1	0.2	4.63	LNX2V682MSEH
		76.2 × 150	18.7	22.0	0.2	5.00	LNX2V822MSEH
	8200	90 × 130	18.2	21.4	0.2	5.00	LNX2V822MSEJ
		76.2 × 170	21.8	25.5	0.2	5.00	LNX2V103MSEH
		90 × 150	21.3	25.3	0.2	5.00	LNX2V103MSEJ
10000	76.2 × 190	25.1	29.1	0.2	5.00	LNX2V123MSEH	
	90 × 150	24.8	28.8	0.2	5.00	LNX2V123MSEJ	
15000	90 × 190	29.0	36.0	0.2	5.00	LNX2V153MSEJ	
18000	90 × 220	32.4	39.7	0.2	5.00	LNX2V183MSEJ	
22000	100 × 220	38.0	43.2	0.2	5.00	LNX2V223MSEK	
27000	100 × 250	42.0	47.0	0.2	5.00	LNX2V273MSEK	
400V (45V) (2G)	1000	51 × 70	3.8	5.0	0.2	1.90	LNX2G102MSEF
	1200	51 × 80	4.5	5.8	0.2	2.08	LNX2G122MSEF
	1500	51 × 100	5.3	6.8	0.2	2.32	LNX2G152MSEF
	1800	51 × 110	6.0	8.2	0.2	2.55	LNX2G182MSEF
	2200	51 × 130	7.0	9.3	0.2	2.81	LNX2G222MSEF
		63.5 × 90	6.8	8.9	0.2	2.81	LNX2G222MSEG
	2700	63.5 × 110	8.2	10.8	0.2	3.12	LNX2G272MSEG
		76.2 × 90	8.1	10.6	0.2	3.12	LNX2G272MSEH
	3300	63.5 × 130	9.6	12.9	0.2	3.45	LNX2G332MSEG
		76.2 × 100	9.3	12.4	0.2	3.45	LNX2G332MSEH
	3900	63.5 × 150	11.0	14.4	0.2	3.75	LNX2G392MSEG
		76.2 × 100	10.5	13.9	0.2	3.75	LNX2G392MSEH
	4700	63.5 × 170	12.6	16.6	0.2	4.11	LNX2G472MSEG
		76.2 × 130	12.3	16.0	0.2	4.11	LNX2G472MSEH
	5600	63.5 × 190	14.7	18.8	0.2	4.49	LNX2G562MSEG
		76.2 × 150	14.3	18.3	0.2	4.49	LNX2G562MSEH
	6800	76.2 × 170	16.7	21.2	0.2	4.95	LNX2G682MSEH
		90 × 130	16.3	20.7	0.2	4.95	LNX2G682MSEJ
	8200	76.2 × 190	19.3	24.1	0.2	5.00	LNX2G822MSEH
		90 × 150	19.0	23.7	0.2	5.00	LNX2G822MSEJ
	10000	76.2 × 220	22.7	28.3	0.2	5.00	LNX2G103MSEH
90 × 170		22.2	28.0	0.2	5.00	LNX2G103MSEJ	
12000	90 × 190	25.5	31.9	0.2	5.00	LNX2G123MSEJ	
15000	100 × 190	29.6	37.0	0.2	5.00	LNX2G153MSEK	
18000	100 × 220	33.0	40.5	0.2	5.00	LNX2G183MSEK	
22000	100 × 250	41.4	44.7	0.2	5.00	LNX2G223MSEK	

● Frequency coefficient of rated ripple current

Frequency (Hz)	60	120	360	1k	10k~
Coefficient	0.82	1.00	1.20	1.35	1.40

- (※ 1) • Standard ripple current:
Ripple current value allowable for the life time of 20,000 hours at 85°C.
(5,000 hours at 85°C for the voltage rating of 500V and 550V, 2,000 hours at 85°C for the voltage rating of 630V)
- (※ 2) • Maximum rated ripple current:
Ripple current value allowable for the life time of 5,000 hours at 85°C.
• Estimated life time of capacitor is calculated by the following formula, taking the operating temperature, inner temperature rise due to the ripple and derated voltage into consideration.

$$L_n = L_0 \times 2^{\frac{85-T}{10}} \times 2^{-\frac{\Delta T}{K}} \times \alpha$$

- Where,
- L_n : Lifetime under normal operating conditions.(h)
 - L_0 : Lifetime under maximum operating temperature of 85°C and applied DC voltage. (28000h)
 - T : Ambient temperature.(°C)
 - ΔT : Inner temperature rise of capacitor due to ripple current(°C)
 - K : Acceleration coefficient for temperature rise due to the ripple current.
when $T+\Delta T \leq 90^\circ\text{C}, K=10$
when $T+\Delta T > 90^\circ\text{C}, K=2.5$
 - α : Life factor

• Life factor α due to the voltage derating shall be decided by the temperature and the applied voltage

Oper.temp.	T ≤ 70°C	70°C < T ≤ 85°C		
Voltage ratio	—	V/V ₀ ≤ 0.8	0.8 < V/V ₀ ≤ 0.9	0.9 < V/V ₀ ≤ 1.0
α	1.0	1.0	0.8	0.7

V : Applied voltage(V) V₀ : Rated voltage(V)

V (Surge) (Code)	Cap.(μF)	Case size φ D×L(mm)	Standard ripple (Arms) ±1	Rated ripple (Arms) ±2	tan δ (MAX)	Leakage current (mA MAX) ±3	Code
450V (50V) (2W)	1000	51 × 80	4.0	5.2	0.2	2.01	LNX2W102MSEF
	1200	51 × 100	4.7	6.3	0.2	2.20	LNX2W122MSEF
	1500	51 × 110	5.4	7.3	0.2	2.46	LNX2W152MSEF
	1800	51 × 130	6.4	8.7	0.2	2.70	LNX2W182MSEF
		63.5 × 90	6.1	7.6	0.2	2.70	LNX2W182MSEG
	2200	63.5 × 110	7.2	9.6	0.2	2.98	LNX2W222MSEG
		76.2 × 90	7.1	9.4	0.2	2.98	LNX2W222MSEH
	2700	63.5 × 130	8.6	11.3	0.2	3.31	LNX2W272MSEG
		76.2 × 100	8.3	11.0	0.2	3.31	LNX2W272MSEH
	3300	63.5 × 150	10.0	13.3	0.2	3.66	LNX2W332MSEG
		76.2 × 110	9.7	12.9	0.2	3.66	LNX2W332MSEH
	3900	63.5 × 170	11.4	15.1	0.2	3.97	LNX2W392MSEG
		76.2 × 130	11.2	14.6	0.2	3.97	LNX2W392MSEH
	4700	63.5 × 190	13.0	17.3	0.2	4.36	LNX2W472MSEG
		76.2 × 150	12.9	16.9	0.2	4.36	LNX2W472MSEH
	5600	76.2 × 170	15.4	19.4	0.2	4.76	LNX2W562MSEH
		90 × 150	15.3	19.1	0.2	4.76	LNX2W562MSEJ
	6800	76.2 × 190	17.3	22.0	0.2	5.00	LNX2W682MSEG
		90 × 150	17.1	21.6	0.2	5.00	LNX2W682MSEJ
	8200	76.2 × 220	20.3	25.7	0.2	5.00	LNX2W822MSEG
		90 × 170	19.8	25.4	0.2	5.00	LNX2W822MSEJ
10000	90 × 190	23.0	29.6	0.2	5.00	LNX2W103MSEJ	
12000	90 × 220	26.9	33.5	0.2	5.00	LNX2W123MSEJ	
15000	100 × 220	31.1	38.0	0.2	5.00	LNX2W153MSEK	
18000	100 × 250	37.0	41.3	0.2	5.00	LNX2W183MSEK	
500V (55V) (2H)	1000	51 × 110	4.2	—	0.2	2.12	LNX2H102MSEF
	1200	63.5 × 90	4.8	—	0.2	2.32	LNX2H122MSEG
	1500	63.5 × 90	5.5	—	0.2	2.60	LNX2H152MSEG
	1800	63.5 × 110	6.5	—	0.2	2.85	LNX2H182MSEG
	2200	63.5 × 130	7.7	—	0.2	3.15	LNX2H222MSEG
	2700	76.2 × 110	8.8	—	0.2	3.49	LNX2H272MSEH
	3300	76.2 × 130	10.4	—	0.2	3.85	LNX2H332MSEH
	3900	76.2 × 150	12.1	—	0.2	4.19	LNX2H392MSEH
	4700	90 × 130	13.7	—	0.2	4.60	LNX2H472MSEH
	5600	90 × 150	15.9	—	0.2	5.00	LNX2H562MSEJ
	6800	90 × 170	18.5	—	0.2	5.00	LNX2H682MSEJ
	8200	90 × 190	21.4	—	0.2	5.00	LNX2H822MSEJ
10000	100 × 190	23.8	—	0.2	5.00	LNX2H103MSEK	
12000	100 × 220	27.8	—	0.2	5.00	LNX2H123MSEK	
550V (60V) (2L)	1000	51 × 130	4.3	—	0.2	2.22	LNX2L102MSEF
	1200	63.5 × 110	5.0	—	0.2	2.44	LNX2L122MSEG
	1500	63.5 × 130	6.0	—	0.2	2.72	LNX2L152MSEG
	1800	76.2 × 110	6.7	—	0.2	2.98	LNX2L182MSEH
	2200	76.2 × 130	8.0	—	0.2	3.30	LNX2L222MSEH
	2700	76.2 × 150	9.4	—	0.2	3.66	LNX2L272MSEH
	3300	76.2 × 170	11.0	—	0.2	4.04	LNX2L332MSEH
	3900	90 × 150	12.5	—	0.2	4.39	LNX2L392MSEJ
	4700	90 × 170	14.5	—	0.2	4.82	LNX2L472MSEJ
	5600	90 × 190	16.6	—	0.2	5.00	LNX2L562MSEJ
	6800	90 × 220	19.5	—	0.2	5.00	LNX2L682MSEJ
	8200	100 × 220	21.6	—	0.2	5.00	LNX2L822MSEK
10000	100 × 250	25.2	—	0.2	5.00	LNX2L103MSEK	
630V (68V) (2J)	1000	63.5 × 130	5.9	—	0.3	2.38	LNX2J102MSEG
	1200	76.2 × 110	6.7	—	0.3	2.61	LNX2J122MSEH
	1500	76.2 × 130	8.1	—	0.3	2.92	LNX2J152MSEH
	1800	76.2 × 150	9.6	—	0.3	3.19	LNX2J182MSEH
	2200	90 × 130	10.7	—	0.3	3.53	LNX2J222MSEJ
	2700	90 × 150	12.6	—	0.3	3.91	LNX2J272MSEJ
	3300	90 × 170	14.7	—	0.3	4.33	LNX2J332MSEJ
	3900	90 × 190	17.3	—	0.3	4.70	LNX2J392MSEJ
	4700	100 × 220	21.4	—	0.3	5.00	LNX2J472MSEK
	5600	100 × 250	24.7	—	0.3	5.00	LNX2J562MSEK

Ripple (Arms) at 85°C 120Hz

(※ 3) Leakage current: $I = 3\sqrt{CV} \times 10^{-3}$ or 5mA, whichever the smaller.

- I : Leakage Current (mA)
- C : Rated Capacitance (μF)
- V : Voltage (V)

• 3-leg bracket is furnished as standard.
In case no-bracket or 2-leg bracket required, please put BN or BB at the end of type number.

- Ex. 3-leg bracket LNX2G472MSEH
2-leg bracket LNX2G472MSEHBB
No bracket LNX2G472MSEHBN

• Flame-retardant type electrolyte is also available.

Please contact to Nichicon representative for the rated ripple current value.