



MICROWAVE CORPORATION v01.1009



# HMC849LP4CE

## HIGH ISOLATION SPDT NON-REFLECTIVE SWITCH, DC - 6 GHz

### Typical Applications

The HMC849LP4CE is ideal for:

- Cellular/4G Infrastructure
- WiMAX, WiBro & Fixed Wireless
- Automotive Telematics
- Mobile Radio
- Test Equipment

### Features

- High Isolation: up to 60 dB
- Single Positive Control: 0/+3V to +5V
- High Input IP3: +52 dBm
- Non-Reflective Design
- "All Off" State
- 24 Lead 4x4 mm QFN Package: 16 mm<sup>2</sup>

### Functional Diagram

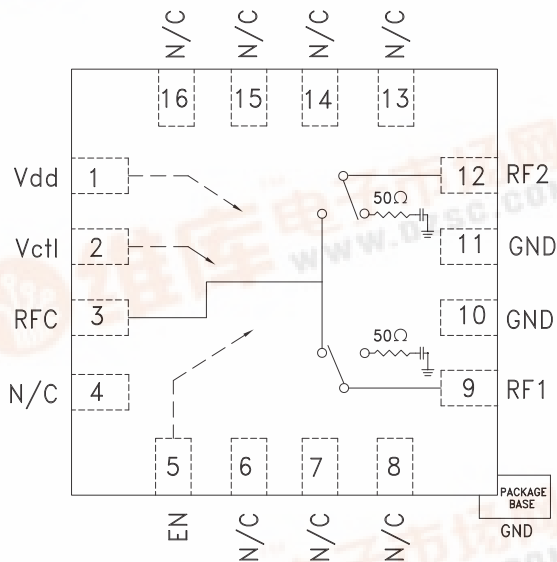

### General Description

The HMC849LP4CE is a high isolation non-reflective DC to 6 GHz GaAs pHEMT SPDT switch in a low cost leadless surface mount package. The switch is ideal for cellular/WiMAX/4G Infrastructure applications yielding up to 60 dB isolation, low 0.8 dB insertion loss and +52 dBm input IP3. Power handling is excellent up through the 5 - 6 GHz WiMAX band with the switch offering a P1dB compression point of +31 dBm. On-chip circuitry allows a single positive voltage control of 0/+3V or 0/+5V at very low DC currents. An enable input (EN) set to logic high will put the switch in an "all off" state.

### Electrical Specifications, $T_A = +25\text{ }^\circ\text{C}$ , $V_{ctl} = 0/V_{dd}$ , $V_{dd} = +3V$ to $+5V$ , 50 Ohm System

| Parameter  | Frequency      | Min.                             | Typ. | Max. | Units |
|--|----------------|----------------------------------|------|------|-------|
| Insertion Loss   | DC - 2.0 GHz   |                                  | 0.8  | 1.3  | dB    |
|  | 2.0 - 4.0 GHz  |                                  | 1.0  | 1.5  | dB    |
|  | 4.0 - 6.0 GHz  |                                  | 1.7  | 2.5  | dB    |
| Isolation (RFC to RF1/RF2)   | DC - 2.0 GHz   | 53                               | 60   |      | dB    |
|  | 2.0 - 4.0 GHz  | 48                               | 55   |      | dB    |
|  | 4.0 - 6.0 GHz  | 40                               | 52   |      | dB    |
| Return Loss (On State)   | DC - 4.0 GHz   |                                  | 17   |      | dB    |
|  | 4.0 - 6.0 GHz  |                                  | 13   |      | dB    |
| Return Loss (Off State)  | DC - 6.0 GHz   |                                  | 15   |      | dB    |
| Input Power for 1 dB Compression   | 0.35 - 4.0 GHz | +3V                              | 29   | 30   | dBm   |
|  |                | +5V                              | 34   | 35   | dBm   |
| Input Third Order Intercept<br>(Two-Tone Input Power = +7 dBm Each Tone) | DC - 6.0 GHz   |                                  | 52   |      | dBm   |
| Switching Speed  | DC - 4.0 GHz   | tRISE, tFALL (10/90% RF)         | 80   |      | ns    |
|  |                | tON, tOFF (50% CTL to 10/90% RF) | 150  |      | ns    |



# HMC849LP4CE

## HIGH ISOLATION SPDT NON-REFLECTIVE SWITCH, DC - 6 GHz

**Insertion Loss**

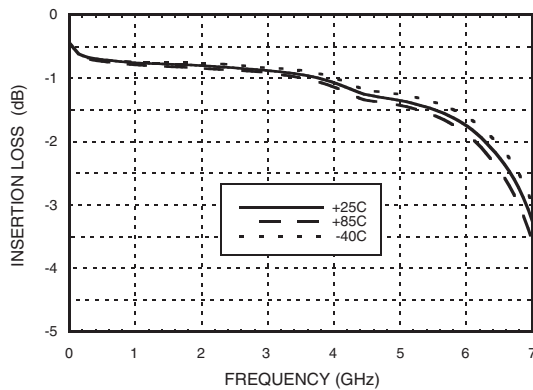

**Return Loss [1]**

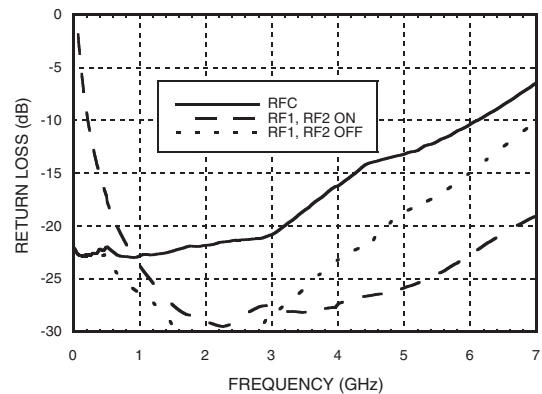

**Isolation Between Ports RFC and RF1 / RF2**

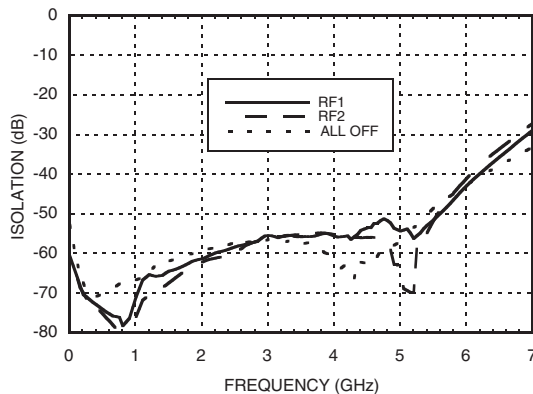

**Isolation Between Ports RF1 and RF2**

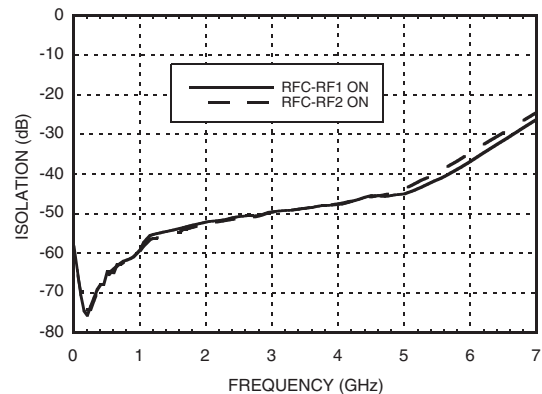

**0.1 and 1 dB Input Compression Point, Vdd = 5V, Linear**

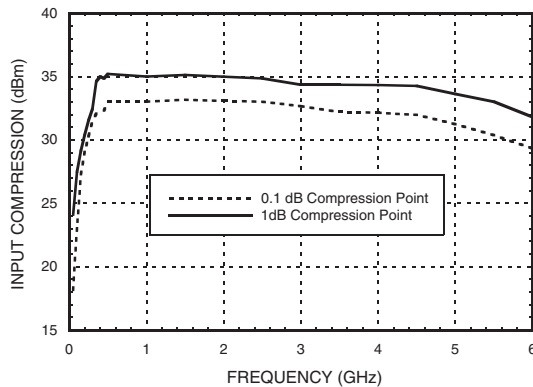

**0.1 and 1 dB Input Compression Point, Vdd = 3V, Linear**

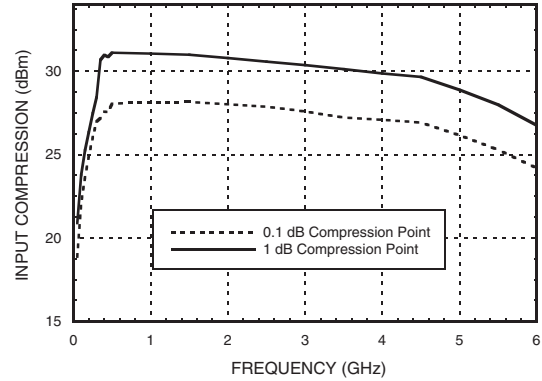

[1] RFC is reflective in "all off" state.



# HMC849LP4CE

## HIGH ISOLATION SPDT NON-REFLECTIVE SWITCH, DC - 6 GHz

**0.1 and 1 dB Input Compression Point, V<sub>dd</sub> = 5V**

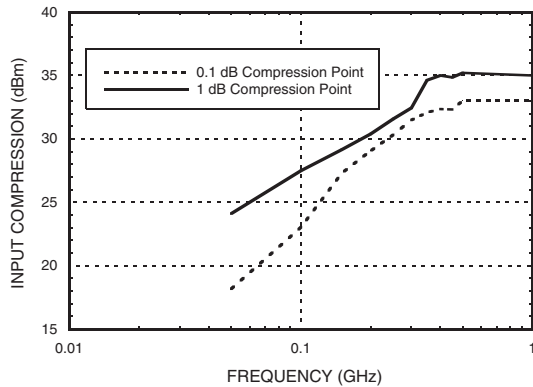

**0.1 and 1 dB Input Compression Point, V<sub>dd</sub> = 3V**

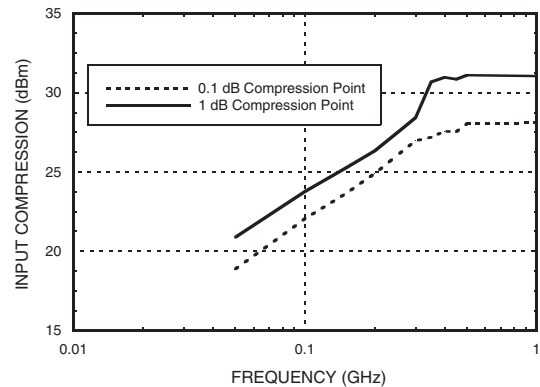

**Input Third Order Intercept Point, V<sub>dd</sub> = 5V, Linear**

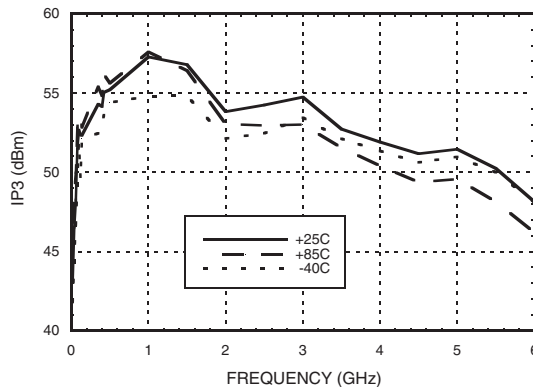

**Input Third Order Intercept Point, V<sub>dd</sub> = 3V, Linear**

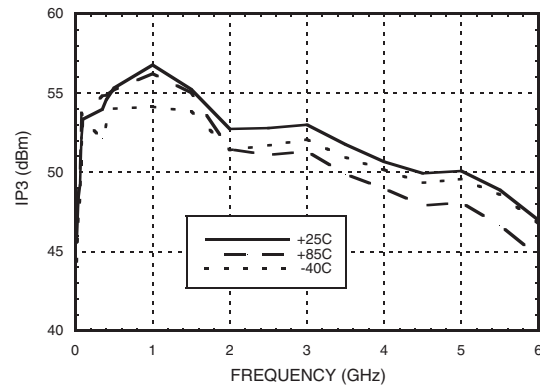

**Input Third Order Intercept Point, V<sub>dd</sub> = 5V**

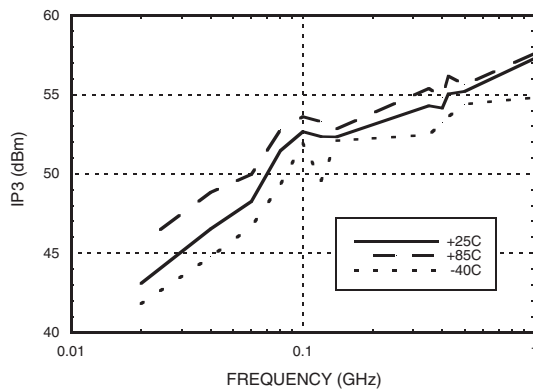

**Input Third Order Intercept Point, V<sub>dd</sub> = 3V**

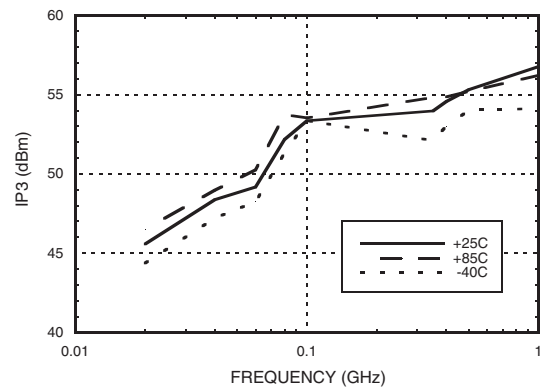



v01.1009

# HMC849LP4CE

## HIGH ISOLATION SPDT NON-REFLECTIVE SWITCH, DC - 6 GHz

### Absolute Maximum Ratings

|   |                |
|---|----------------|
| Bias Voltage (Vdd)  | 7V             |
| Control Voltage (Vctl, EN)  | -1V to Vdd +1V |
| RF Input Power *  |                |
| Through Path 3V/5V  | 30.60 / 33 dBm |
| Termination Path 3V/5V  | 26.4 dBm       |
| Channel Temperature   | 150 °C         |
| Continuous P <sub>diss</sub> (T = 85 °C)<br>(derate 17.6 mW/°C for through path, and<br>6.8 mW/°C for termination path above 85 °C) |                |
| Through Path  | 1.144 W        |
| Termination Path  | 0.441 W        |
| Thermal Resistance<br>(channel to package bottom)   |                |
| Through Path  | 56.8 °C/W      |
| Termination Path  | 147.3 °C/W     |
| Storage Temperature   | -65 to +150 °C |
| Operating Temperature   | -40 to +85 °C  |
| ESD Sensitivity (HBM)   | Class 1A       |

\* The RF input power is quite lower than the breakdown power levels. Hence, the only concern with this product is the thermal limit.



ELECTROSTATIC SENSITIVE DEVICE  
OBSERVE HANDLING PRECAUTIONS

### Bias Voltage & Current

| Vdd (V) | I <sub>dd</sub> (Typ.) (mA) |
|---------|-----------------------------|
| 3       | 0.80                        |
| 5       | 0.85                        |

### Digital Control Voltages

| State | Bias Condition                               |
|-------|--|
| Low   | 0 to +0.8 V <sub>dc</sub> @ <1 μA Typical    |
| High  | +2.0 to +5.0 V <sub>dc</sub> @ 30 μA Typical |

### Truth Table

| Control Input |      | Signal Path State |           |
|---------------|------|-------------------|-----------|
| Vctl          | EN   | RFC - RF1         | RFC - RF2 |
| Low           | Low  | OFF               | ON        |
| High          | Low  | ON                | OFF       |
| Low           | High | OFF               | OFF       |
| High          | High | OFF               | OFF       |



# HMC849LP4CE

## HIGH ISOLATION SPDT NON-REFLECTIVE SWITCH, DC - 6 GHz

### Outline Drawing

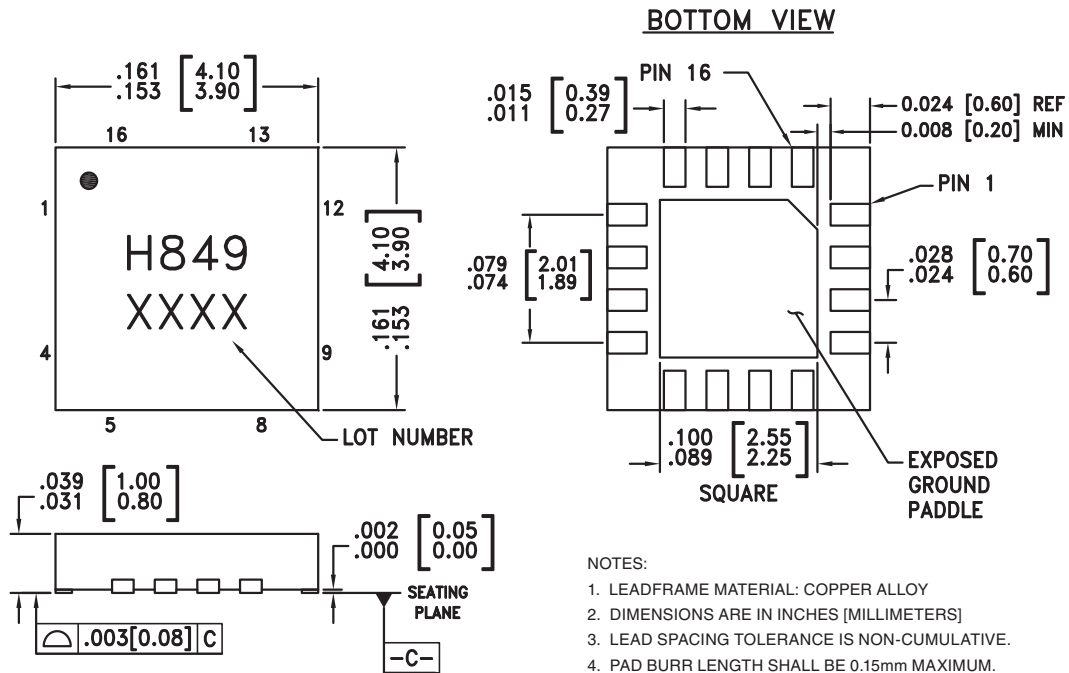

- NOTES:
1. LEADFRAME MATERIAL: COPPER ALLOY
  2. DIMENSIONS ARE IN INCHES [MILLIMETERS]
  3. LEAD SPACING TOLERANCE IS NON-CUMULATIVE.
  4. PAD BURR LENGTH SHALL BE 0.15mm MAXIMUM.  
PAD BURR HEIGHT SHALL BE 0.05mm MAXIMUM.
  5. PACKAGE WARP SHALL NOT EXCEED 0.05mm.
  6. ALL GROUND LEADS AND GROUND PADDLE MUST BE SOLDERED TO PCB RF GROUND.
  7. REFER TO HITTITE APPLICATION NOTE FOR SUGGESTED LAND PATTERN.

### Package Information

| Part Number | Package Body Material                              | Lead Finish   | MSL Rating          | Package Marking <sup>[1]</sup> |
|-------------|--|---------------|---------------------|--------------------------------|
| HMC849LP4CE | RoHS-compliant Low Stress Injection Molded Plastic | 100% matte Sn | MSL1 <sup>[2]</sup> | H849<br>XXXX                   |

[1] 4-Digit lot number XXXX

[2] Max peak reflow temperature of 260 °C



v01.1009



# HMC849LP4CE

## HIGH ISOLATION SPDT NON-REFLECTIVE SWITCH, DC - 6 GHz

### Pin Descriptions

| Pin Number                 | Function      | Description  | Interface Schematic |
|----------------------------|---------------|--|---------------------|
| 1                          | Vdd           | Supply Voltage.  |                     |
| 2                          | Vctl          | Control input. See truth and control voltage tables.   |                     |
| 3, 9, 12                   | RFC, RF1, RF2 | These pins are DC coupled and matched to 50 Ohms. Blocking capacitors are required.  |                     |
| 4, 6, 7, 8, 13, 14, 15, 16 | N/C           | The pins are not connected internally; however, all data shown herein was measured with these pins connected to RF/DC ground externally. |                     |
| 5                          | EN            | Enable. See truth and control voltage tables.  |                     |
| 10, 11                     | GND           | Package bottom must also be connected to PCB RF ground.  |                     |

### Application Circuit

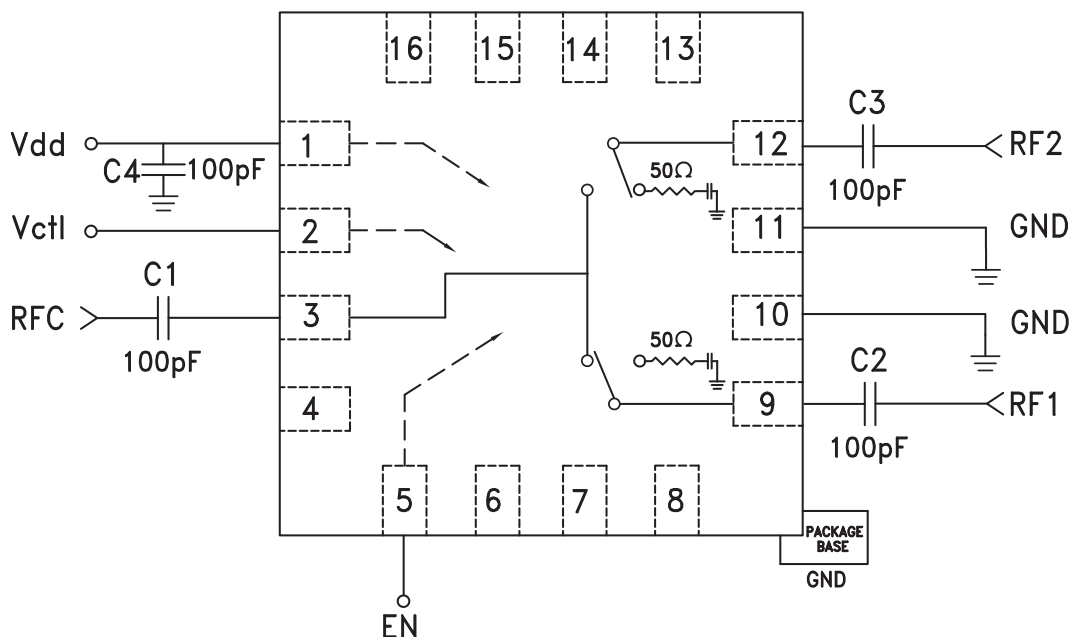

For price, delivery, and to place orders, please contact Hittite Microwave Corporation:  
 20 Alpha Road, Chelmsford, MA 01824 Phone: 978-250-3343 Fax: 978-250-3373  
 Order On-line at [www.hittite.com](http://www.hittite.com)



MICROWAVE CORPORATION v01.1009



# HMC849LP4CE

**HIGH ISOLATION SPDT  
NON-REFLECTIVE SWITCH, DC - 6 GHz**

## Evaluation PCB

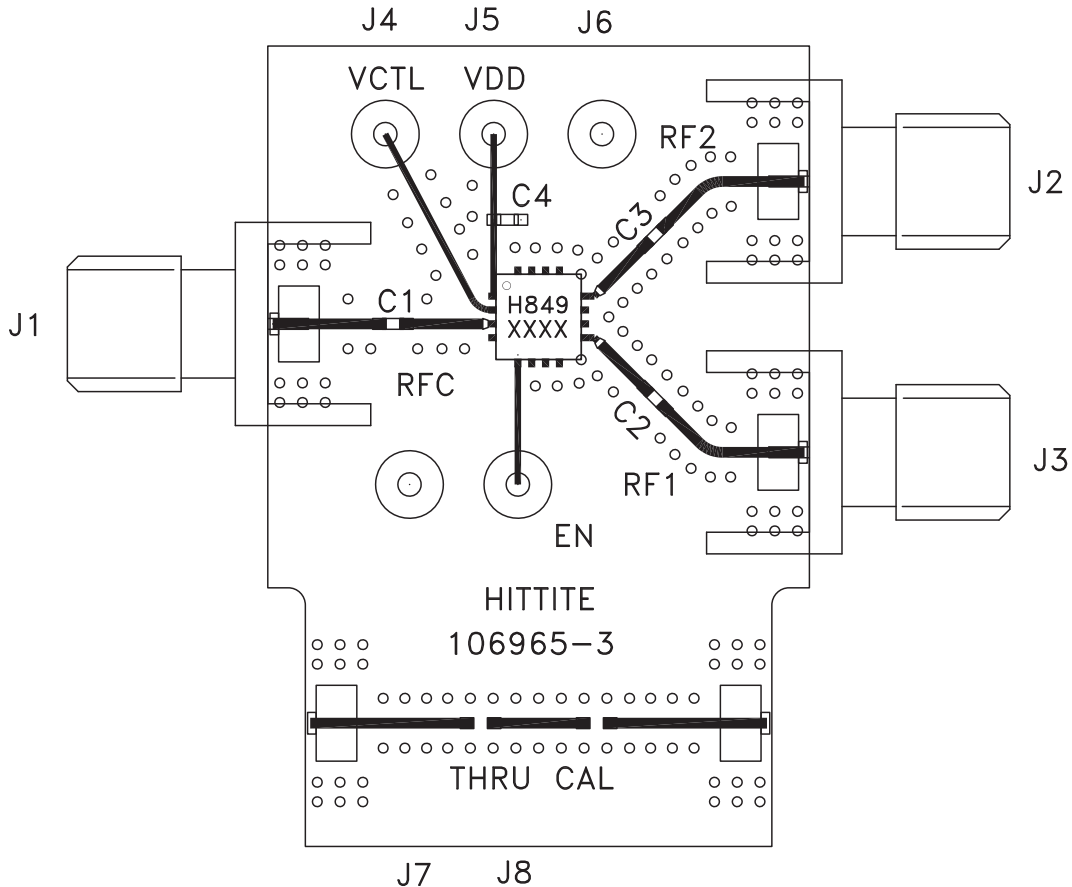

### List of Materials for Evaluation PCB 106975 [1]

| Item    | Description                 |
|---------|-----------------------------|
| J1 - J3 | PC Mount SMA RF Connector   |
| J4 - J8 | DC Pin                      |
| C1 - C4 | 100 pF Capacitor, 0402 Pkg. |
| U1      | HMC849LP4CE SPDT Switch     |
| PCB [2] | 106965 Evaluation PCB       |

[1] Reference this number when ordering complete evaluation PCB

[2] Circuit Board Material: Rogers 4350 or Arlon 25FR

The circuit board used in the final application should be generated with proper RF circuit design techniques. Signal lines at the RF port should have 50 Ohm impedance and the package ground leads and backside ground slug should be connected directly to the ground plane similar to that shown above. The evaluation circuit board shown above is available from Hittite Microwave Corporation upon request.

[查询"HMC849LP4CE"供应商](#)



## HMC849LP4CE

**HIGH ISOLATION SPDT  
NON-REFLECTIVE SWITCH, DC - 6 GHz**

**Notes:**



**This datasheet has been downloaded from:**

**[www.EEworld.com.cn](http://www.EEworld.com.cn)**

**Free Download**

**Daily Updated Database**

**100% Free Datasheet Search Site**

**100% Free IC Replacement Search Site**

**Convenient Electronic Dictionary**

**Fast Search System**

**[www.EEworld.com.cn](http://www.EEworld.com.cn)**