



## LMH6601/LMH6601Q

### 250 MHz, 2.4V CMOS Operational Amplifier with Shutdown

#### General Description

The LMH6601 is a low voltage (2.4V – 5.5V), high speed voltage feedback operational amplifier suitable for use in a variety of consumer and industrial applications. With a bandwidth of 125 MHz at a gain of +2 and guaranteed high output current of 100 mA, the LMH6601 is an ideal choice for video line driver applications including HDTV. Low input bias current (50 pA maximum), rail-to-rail output, and low current noise allow the LMH6601 to be used in various industrial applications such as transimpedance amplifiers, active filters, or high-impedance buffers. The LMH6601 is an attractive solution for systems which require high performance at low supply voltages. The LMH6601 is available in a 6-pin SC70 package, and includes a micropower shutdown feature.

#### Features

$V_S = 3.3V$ ,  $T_A = 25^\circ C$ ,  $A_V = 2 V/V$ ,  $R_L = 150\Omega$  to  $V^-$ , unless specified.

- 125 MHz –3 dB small signal bandwidth
- 75 MHz –3 dB large signal bandwidth
- 30 MHz large signal 0.1 dB gain flatness
- 260 V/ $\mu s$  slew rate
- 0.25%/0.25° differential gain/differential phase
- Rail-to-rail output
- 2.4V – 5.5V single supply operating range
- 6-Pin SC70 Package
- LMH6601Q is AEC-Q100 grade 3 qualified and is manufactured on an automotive grade flow

#### Applications

- Video amplifier
- Charge amplifier
- Set-top box
- Sample & hold
- Transimpedance amplifier
- Line driver
- High impedance buffer
- Automotive

Response at a Gain of +2 for Various Supply Voltages

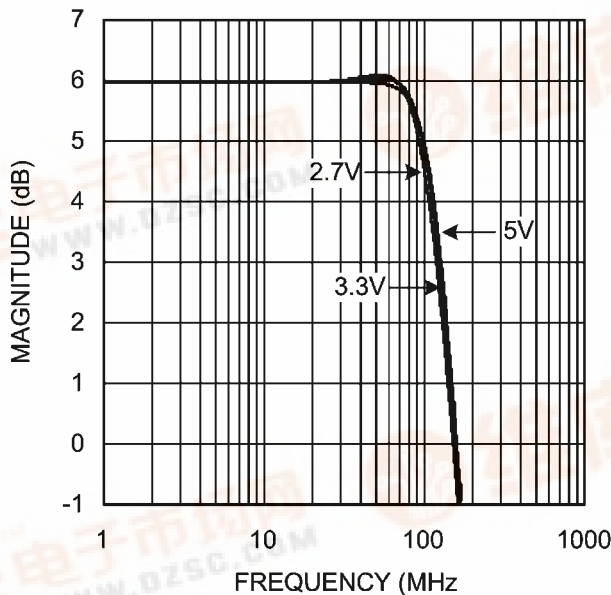

20136441



**Absolute Maximum Ratings** (Note 1)

查询"LMH6601"供应商

If Military/Aerospace specified devices are required, please contact the National Semiconductor Sales Office/Distributors for availability and specifications.

## ESD Tolerance (Note 4)

Human Body Model	2 kV
Machine Model	200V
$V_{IN}$ Differential	$\pm 2.5V$
Input Current	$\pm 10$ mA
Output Current	200 mA (Note 3)
Supply Voltage ( $V^+ - V^-$ )	6.0V
Voltage at Input/Output Pins	$V^+ + 0.5V, V^- - 0.5V$

Storage Temperature Range	$-65^\circ\text{C}$ to $+150^\circ\text{C}$
Junction Temperature	$+150^\circ\text{C}$
Soldering Information	
Infrared or Convection (20 sec.)	235 $^\circ\text{C}$
Wave Soldering (10 sec.)	260 $^\circ\text{C}$

**Operating Ratings** (Note 1)

Supply Voltage ( $V^+ - V^-$ )	2.4V to 5.5V
Operating Temperature Range	$-40^\circ\text{C}$ to $+85^\circ\text{C}$
Package Thermal Resistance ( $\theta_{JA}$ )	414 $^\circ\text{C/W}$
6-pin SC70	

**5V Electrical Characteristics**

Single Supply with  $V_S = 5V$ ,  $A_V = +2$ ,  $R_F = 604\Omega$ ,  $\overline{SD}$  tied to  $V^+$ ,  $V_{OUT} = V_S/2$ ,  $R_L = 150\Omega$  to  $V^-$  unless otherwise specified. **Boldface** limits apply at temperature extremes. (Note 2)

Symbol	Parameter	Condition	Min (Note 6)	Typ (Note 6)	Max (Note 6)	Units
<b>Frequency Domain Response</b>						
SSBW	-3 dB Bandwidth Small Signal	$V_{OUT} = 0.25 V_{PP}$		130		MHz
SSBW_1		$V_{OUT} = 0.25 V_{PP}, A_V = +1$		250		
Peak	Peaking	$V_{OUT} = 0.25 V_{PP}, A_V = +1$		2.5		dB
Peak_1	Peaking	$V_{OUT} = 0.25 V_{PP}$		0		dB
LSBW	-3 dB Bandwidth Large Signal	$V_{OUT} = 2 V_{PP}$		81		MHz
Peak_2	Peaking	$V_{OUT} = 2 V_{PP}$		0		dB
0.1 dB BW	0.1 dB Bandwidth	$V_{OUT} = 2 V_{PP}$		30		MHz
GBWP_1k	Gain Bandwidth Product	Unity Gain, $R_L = 1\text{ k}\Omega$ to $V_S/2$		155		MHz
GBWP_150		Unity Gain, $R_L = 150\Omega$ to $V_S/2$		125		
$A_{VOL}$	Large Signal Open Loop Gain	$0.5V < V_{OUT} < 4.5V$	56	66		dB
PBW	Full Power BW	$-1$ dB, $A_V = +4$ , $V_{OUT} = 4.2 V_{PP}$ , $R_L = 150\Omega$ to $V_S/2$		30		MHz
DG	Differential Gain	4.43 MHz, $1.7V \leq V_{OUT} \leq 3.3V$ , $R_L = 150\Omega$ to $V^-$		0.06		%
DP	Differential Phase	4.43 MHz, $1.7V \leq V_{OUT} \leq 3.3V$ , $R_L = 150\Omega$ to $V^-$		0.10		deg
<b>Time Domain Response</b>						
TRS/TRL	Rise & Fall Time	0.25V Step		2.6		ns
OS	Overshoot	0.25V Step		10		%
SR	Slew Rate	2V Step		275		V/ $\mu\text{s}$
$T_S$	Settling Time	1V Step, $\pm 0.1\%$		50		ns
$T_{S_1}$		1V Step, $\pm 0.02\%$		220		
PD	Propagation Delay	Input to Output, 250 mV Step, 50%		2.4		ns
$C_L$	Cap Load Tolerance	$A_V = -1$ , 10% Overshoot, 75 $\Omega$ in Series		50		pF
<b>Distortion &amp; Noise Performance</b>						
HD2	Harmonic Distortion (2 <sup>nd</sup> )	2 $V_{PP}$ , 10 MHz		-56		dBc
HD2_1		4 $V_{PP}$ , 10 MHz, $R_L = 1\text{ k}\Omega$ to $V_S/2$		-61		
HD3	Harmonic Distortion (3 <sup>rd</sup> )	2 $V_{PP}$ , 10 MHz		-73		dBc
HD3_1		4 $V_{PP}$ , 10 MHz, $R_L = 1\text{ k}\Omega$ to $V_S/2$		-64		
THD	Total Harmonic Distortion	4 $V_{PP}$ , 10 MHz, $R_L = 1\text{ k}\Omega$ to $V_S/2$		-58		
$V_{N1}$	Input Voltage Noise	>10 MHz		7		nV/ $\sqrt{\text{Hz}}$
$V_{N2}$		1 MHz		10		

Symbol	Parameter	Condition	Min (Note 6)	Typ (Note 6)	Max (Note 6)	Units
$I_N$	Input Current Noise	>1 MHz		50		fA/√Hz
<b>Static, DC Performance</b>						
$V_{IO}$	Input Offset Voltage			±1	±2.4 ±5.0	mV
$DV_{IO}$	Input Offset Voltage Average Drift	(Note 8)		-5		μV/°C
$I_B$	Input Bias Current	(Note 9)		5	50	pA
$I_{OS}$	Input Offset Current	(Note 9)		2	25	pA
$R_{IN}$	Input Resistance	$0V \leq V_{IN} \leq 3.5V$		10		TΩ
$C_{IN}$	Input Capacitance			1.3		pF
+PSRR	Positive Power Supply Rejection Ratio	DC	55 51	59		dB
-PSRR	Negative Power Supply Rejection Ratio	DC	53 50	61		dB
CMRR	Common Mode Rejection Ratio	DC	56 53	68		dB
CMVR	Input Voltage Range	CMRR > 50 dB	V- -0.20	-	V+ - 1.5	V
$I_{CC}$	Supply Current	Normal Operation $V_{OUT} = V_S/2$		9.6	11.5 13.5	mA
		Shutdown $\overline{SD}$ tied to $\leq 0.5V$ (Note 5)		100		nA
VOH1	Output High Voltage (Relative to V+)	$R_L = 150\Omega$ to V-	-210 -480	-190		mV
VOH2		$R_L = 75\Omega$ to $V_S/2$		-190		
VOH3		$R_L = 10\text{ k}\Omega$ to V-	-60 -110	-12		
VOL1	Output Low Voltage (Relative to V-)	$R_L = 150\Omega$ to V-		+5	+45 +125	mV
VOL2		$R_L = 75\Omega$ to $V_S/2$		+120		
VOL3		$R_L = 10\text{ k}\Omega$ to V-		+5	+45 +125	
$I_O$	Output Current	$V_{OUT} < 0.6V$ from Respective Supply	Source		150	mA
			Sink		180	
$I_{O-1}$		$V_{OUT} = V_S/2$ , $V_{ID} = \pm 18\text{ mV}$ (Note 10)	±100			
Load	Output Load Rating	THD < -30 dBc, f = 200 kHz, $R_L$ tied to $V_S/2$ , $V_{OUT} = 4 V_{PP}$		20		Ω
$R_{O\_Enabled}$	Output Resistance	Enabled, $A_V = +1$		0.2		Ω
$R_{O\_Disabled}$	Output Resistance	Shutdown		>100		MΩ
$C_{O\_Disabled}$	Output Capacitance	Shutdown		5.0		pF
<b>Miscellaneous Performance</b>						
VDMAX	Voltage Limit for Disable (Pin 5)	(Note 5)	0		0.5	V
VDMIN	Voltage Limit for Enable (Pin 5)	(Note 5)	4.5		5.0	V
$I_i$	Logic Input Current (Pin 5)	$\overline{SD} = 5V$ (Note 5)		10		pA
$V_{glitch}$	Turn-on Glitch			2.2		V
$T_{on}$	Turn-on Time			1.4		μs
$T_{off}$	Turn-off Time			520		ns
Isolation <sub>OFF</sub>	Off Isolation	1 MHz, $R_L = 1\text{ k}\Omega$		60		dB
$T_{OL}$	Overload Recovery			<20		ns

### 3.3V Electrical Characteristics

Single Supply with  $V_S = 3.3V$ ,  $A_V = +2$ ,  $R_F = 604\Omega$ ,  $\overline{SD}$  tied to  $V^+$ ,  $V_{OUT}$  to  $V_S/2$  or  $V^-$  unless otherwise specified. **Boldface** limits apply at temperature extremes. (Note 2)

Symbol	Parameter	Condition	Min (Note 6)	Typ (Note 6)	Max (Note 6)	Units
<b>Frequency Domain Response</b>						
SSBW	-3 dB Bandwidth Small Signal	$V_{OUT} = 0.25 V_{PP}$		125		MHz
SSBW_1		$V_{OUT} = 0.25 V_{PP}$ , $A_V = +1$		250		
Peak	Peaking	$V_{OUT} = 0.25 V_{PP}$ , $A_V = +1$		3		dB
Peak_1	Peaking	$V_{OUT} = 0.25 V_{PP}$		0.05		dB
LSBW	-3 dB Bandwidth Large Signal	$V_{OUT} = 2 V_{PP}$		75		MHz
Peak_2	Peaking	$V_{OUT} = 2 V_{PP}$		0		dB
0.1 dB BW	0.1 dB Bandwidth	$V_{OUT} = 2 V_{PP}$		30		MHz
GBWP_1k	Gain Bandwidth Product	Unity Gain, $R_L = 1 k\Omega$ to $V_S/2$		115		MHz
GBWP_150		Unity Gain, $R_L = 150\Omega$ to $V_S/2$		105		
$A_{VOL}$	Large Signal Open Loop Gain	$0.3V < V_{OUT} < 3V$	56	67		dB
PBW	Full Power BW	-1 dB, $A_V = +4$ , $V_{OUT} = 2.8V_{PP}$ , $R_L = 150\Omega$ to $V_S/2$		30		MHz
DG	Differential Gain	4.43 MHz, $0.85V \leq V_{OUT} \leq 2.45V$ , $R_L = 150\Omega$ to $V^-$		0.06		%
DP	Differential Phase	4.43 MHz, $0.85V \leq V_{OUT} \leq 2.45V$ , $R_L = 150\Omega$ to $V^-$		0.23		deg
<b>Time Domain Response</b>						
TRS/TRL	Rise & Fall Time	0.25V Step		2.7		ns
OS	Overshoot	0.25V Step		10		%
SR	Slew Rate	2V Step		260		V/ $\mu$ s
$T_S$	Settling Time	1V Step, $\pm 0.1\%$		70		ns
$T_{S,1}$		1V Step, $\pm 0.02\%$		300		
PD	Propagation Delay	Input to Output, 250 mV Step, 50%		2.6		ns
$C_L$	Cap Load Tolerance	$A_V = -1$ , 10% Overshoot, 82 $\Omega$ in Series		50		pF
<b>Distortion &amp; Noise Performance</b>						
HD2	Harmonic Distortion (2 <sup>nd</sup> )	$2 V_{PP}$ , 10 MHz		-61		dBc
HD2_1		$2 V_{PP}$ , 10 MHz $R_L = 1 k\Omega$ to $V_S/2$		-79		
HD3	Harmonic Distortion (3 <sup>rd</sup> )	$2 V_{PP}$ , 10 MHz		-53		dBc
HD3_2		$2 V_{PP}$ , 10 MHz $R_L = 1 k\Omega$ to $V_S/2$		-69		
THD	Total Harmonic Distortion	$2 V_{PP}$ , 10 MHz $R_L = 1 k\Omega$ to $V_S/2$		-66		dBc
$V_{N1}$	Input Voltage Noise	>10 MHz		7		nV/ $\sqrt{Hz}$
$V_{N2}$		1 MHz		10		
$I_N$	Input Current Noise	>1 MHz		50		fA/ $\sqrt{Hz}$
<b>Static, DC Performance</b>						
$V_{IO}$	Input Offset Voltage			$\pm 1$	$\pm 2.6$ <b><math>\pm 5.5</math></b>	mV
$DV_{IO}$	Input Offset Voltage Average Drift	(Note 8)		-4.5		$\mu$ V/ $^{\circ}$ C
$I_B$	Input Bias Current	(Note 9)		5	50	pA
$I_{OS}$	Input Offset Current	(Note 9)		2	25	pA
$R_{IN}$	Input Resistance	$0V \leq V_{IN} \leq 1.8V$		15		T $\Omega$
$C_{IN}$	Input Capacitance			1.4		pF

Symbol	Parameter	Condition	Min (Note 6)	Typ (Note 6)	Max (Note 6)	Units
+PSRR	Positive Power Supply Rejection Ratio	DC	61 <b>51</b>	80		dB
-PSRR	Negative Power Supply Rejection Ratio	DC	57 <b>52</b>	72		dB
CMRR	Common Mode Rejection Ratio	DC	58 <b>55</b>	73		dB
CMVR	Input Voltage Range	CMRR > 50 dB	<b>V- -0.20</b>	-	<b>V+ -1.5</b>	V
I <sub>CC</sub>	Supply Current	Normal Operation V <sub>OUT</sub> = V <sub>S</sub> /2		9.2	11 <b>13</b>	mA
		Shutdown SD tied to ≤ 0.33V (Note 5)		100		nA
VOH1	Output High Voltage (Relative to V <sup>+</sup> )	R <sub>L</sub> = 150Ω to V <sup>-</sup>	-210 <b>-360</b>	-190		mV
VOH2		R <sub>L</sub> = 75Ω to V <sub>S</sub> /2		-190		
VOH3		R <sub>L</sub> = 10 kΩ to V <sup>-</sup>	-50 <b>-100</b>	-10		
VOL1	Output Low Voltage (Relative to V <sup>-</sup> )	R <sub>L</sub> = 150Ω to V <sup>-</sup>		+4	+45 <b>+125</b>	mV
VOL2		R <sub>L</sub> = 75Ω to V <sub>S</sub> /2		+105		
VOL3		R <sub>L</sub> = 10 kΩ to V <sup>-</sup>		+4	+45 <b>+125</b>	
I <sub>O</sub>	Output Current	V <sub>OUT</sub> < 0.6V from Respective Supply	Source	50		mA
I <sub>O-1</sub>			Sink	75		
		V <sub>OUT</sub> = V <sub>S</sub> /2, V <sub>ID</sub> = ±18 mV (Note 10)	±75			
Load	Output Load Rating	THD < -30 dBc, f = 200 kHz, R <sub>L</sub> tied to V <sub>S</sub> /2, V <sub>OUT</sub> = 2.6 V <sub>PP</sub>		25		Ω
R <sub>O-Enabled</sub>	Output Resistance	Enabled, A <sub>V</sub> = +1		0.2		Ω
R <sub>O-Disabled</sub>	Output Resistance	Shutdown		>100		MΩ
C <sub>O-Disabled</sub>	Output Capacitance	Shutdown		5.6		pF
<b>Miscellaneous Performance</b>						
V <sub>DMAX</sub>	Voltage Limit for Disable (Pin 5)	(Note 5)	<b>0</b>		<b>0.33</b>	V
V <sub>DMIN</sub>	Voltage Limit for Enable (Pin 5)	(Note 5)	<b>2.97</b>		<b>3.3</b>	V
I <sub>i</sub>	Logic Input Current (Pin 5)	SD = 3.3V (Note 5)		8		pA
V <sub>glitch</sub>	Turn-on Glitch			1.6		V
T <sub>on</sub>	Turn-on Time			3.5		μs
T <sub>off</sub>	Turn-off Time			500		ns
Isolation <sub>OFF</sub>	Off Isolation	1 MHz, R <sub>L</sub> = 1 kΩ		60		dB

## 2.7V Electrical Characteristics

Single Supply with  $V_S = 2.7V$ ,  $A_V = +2$ ,  $R_F = 604\Omega$ ,  $\overline{SD}$  tied to  $V^+$ ,  $V_{OUT} =$   $V_{IN}$  unless otherwise specified. **Boldface** limits apply at temperature extremes. (Note 2)

Symbol	Parameter	Condition	Min (Note 6)	Typ (Note 6)	Max (Note 6)	Units
<b>Frequency Domain Response</b>						
SSBW	-3 dB Bandwidth Small Signal	$V_{OUT} = 0.25 V_{PP}$		120		MHz
SSBW_1		$V_{OUT} = 0.25 V_{PP}$ , $A_V = +1$		250		
Peak	Peaking	$V_{OUT} = 0.25 V_{PP}$ , $A_V = +1$		3.1		dB
Peak_1	Peaking	$V_{OUT} = 0.25 V_{PP}$		0.1		dB
LSBW	-3 dB Bandwidth Large Signal	$V_{OUT} = 2 V_{PP}$		73		MHz
Peak_2	Peaking	$V_{OUT} = 2 V_{PP}$		0		dB
0.1 dB BW	0.1 dB Bandwidth	$V_{OUT} = 2V_{PP}$		30		MHz
GBWP_1k	Gain Bandwidth Product	Unity Gain, $R_L = 1 k\Omega$ to $V_S/2$		110		MHz
GBWP_150		Unity Gain, $R_L = 150\Omega$ to $V_S/2$		81		
$A_{VOL}$	Large Signal Open Loop Gain	$0.25V < V_{OUT} < 2.5V$	56	65		dB
PBW	Full Power BW	-1 dB, $A_V = +4$ , $V_{OUT} = 2 V_{PP}$ , $R_L = 150\Omega$ to $V_S/2$		13		MHz
DG	Differential Gain	4.43 MHz, $0.45V \leq V_{OUT} \leq 2.05V$ $R_L = 150\Omega$ to $V^-$		0.12		%
DP	Differential Phase	4.43 MHz, $0.45V \leq V_{OUT} \leq 2.05V$ $R_L = 150\Omega$ to $V^-$		0.62		deg
<b>Time Domain Response</b>						
TRS/TRL	Rise & Fall Time	0.25V Step		2.7		ns
OS	Overshoot	0.25V Step		10		%
SR	Slew Rate	2V Step		260		V/ $\mu$ s
$T_S$	Settling Time	1V Step, $\pm 0.1\%$		147		ns
$T_{S_1}$		1V Step, $\pm 0.02\%$		410		
PD	Propagation Delay	Input to Output, 250 mV Step, 50%		3.4		ns
<b>Distortion &amp; Noise Performance</b>						
HD2	Harmonic Distortion (2 <sup>nd</sup> )	1 $V_{PP}$ , 10 MHz		-58		dBc
HD3	Harmonic Distortion (3 <sup>rd</sup> )	1 $V_{PP}$ , 10 MHz		-60		dBc
$V_{N1}$	Input Voltage Noise	>10 MHz		8.4		nV/ $\sqrt{Hz}$
$V_{N2}$		1 MHz		12		
$I_N$	Input Current Noise	>1 MHz		50		fA/ $\sqrt{Hz}$
<b>Static, DC Performance</b>						
$V_{IO}$	Input Offset Voltage			$\pm 1$	$\pm 3.5$ <b><math>\pm 6.5</math></b>	mV
$DV_{IO}$	Input Offset Voltage Average Drift	(Note 8)		-6.5		$\mu$ V/ $^{\circ}$ C
$I_B$	Input Bias Current	(Note 9)		5	50	pA
$I_{OS}$	Input Offset Current	(Note 9)		2	25	pA
$R_{IN}$	Input Resistance	$0V \leq V_{IN} \leq 1.2V$		20		T $\Omega$
$C_{IN}$	Input Capacitance			1.6		pF
+PSRR	Positive Power Supply Rejection Ratio	DC	58 53	68		dB
-PSRR	Negative Power Supply Rejection Ratio	DC	56 53	69		dB
CMRR	Common Mode Rejection Ratio	DC	57 52	77		dB
CMVR	Input Voltage Range	CMRR > 50 dB	<b>V- -0.20</b>	-	<b>V+ -1.5</b>	V

Symbol	Parameter	Condition	Min (Note 6)	Typ (Note 6)	Max (Note 6)	Units
I <sub>CC</sub>	Supply Current	Normal Operation $V_{OUT} = V_S/2$		9.0	10.6 <b>12.5</b>	mA
		Shutdown $\overline{SD}$ tied to $\leq 0.27V$ (Note 5)		100		nA
VOH1	Output High Voltage (Relative to V <sup>+</sup> )	$R_L = 150\Omega$ to V <sup>-</sup>	-260 <b>-420</b>	-200		mV
VOH2		$R_L = 75\Omega$ to $V_S/2$		-200		
VOH3		$R_L = 10\text{ k}\Omega$ to V <sup>-</sup>	-50 <b>100</b>	-10		
VOL1	Output Low Voltage (Relative to V <sup>-</sup> )	$R_L = 150\Omega$ to V <sup>-</sup>		+4	+45 <b>+125</b>	mV
VOL2		$R_L = 75\Omega$ to $V_S/2$		+125		
VOL3		$R_L = 10\text{ k}\Omega$ to V <sup>-</sup>		+4	+45 <b>125</b>	
I <sub>O</sub>	Output Current	$V_{OUT} \leq 0.6V$ from Respective Supply	Source		25	mA
I <sub>O-1</sub>			Sink		62	
		$V_{OUT} = V_S/2$ , $V_{ID} = \pm 18\text{ mV}$ (Note 10)	Source	25		
	Sink		35			
Load	Output Load Rating	THD < -30 dBc, f = 200 kHz, $R_L$ tied to $V_S/2$ , $V_{OUT} = 2.2 V_{PP}$		40		$\Omega$
R <sub>O_Enable</sub>	Output Resistance	Enabled, $A_V = +1$		0.2		$\Omega$
R <sub>O_Disabled</sub>	Output Resistance	Shutdown		>100		M $\Omega$
C <sub>O_Disabled</sub>	Output Capacitance	Shutdown		5.6		pF
<b>Miscellaneous Performance</b>						
V <sub>DMAX</sub>	Voltage Limit for Disable (Pin 5)	(Note 5)	<b>0</b>		<b>0.27</b>	V
V <sub>DMIN</sub>	Voltage Limit for Enable (Pin 5)	(Note 5)	<b>2.43</b>		<b>2.7</b>	V
I <sub>i</sub>	Logic Input Current (Pin 5)	$\overline{SD} = 2.7V$ (Note 5)		4		pA
V <sub>glitch</sub>	Turn-on Glitch			1.2		V
T <sub>on</sub>	Turn-on Time			5.2		$\mu$ s
T <sub>off</sub>	Turn-off Time			760		ns
Isolation <sub>OFF</sub>	Off Isolation	1 MHz, $R_L = 1\text{ k}\Omega$		60		dB

**Note 1:** Absolute Maximum Ratings indicate limits beyond which damage to the device may occur. Operating Ratings indicate conditions for which the device is intended to be functional, but specific performance is not guaranteed. For guaranteed specifications and the test conditions, see the Electrical Characteristics.

**Note 2:** Electrical Table values apply only for factory testing conditions at the temperature indicated. Factory testing conditions result in very limited self-heating of the device such that  $T_J = T_A$ . No guarantee of parametric performance is indicated in the electrical tables under conditions of internal self-heating where  $T_J > T_A$ .

**Note 3:** The maximum continuous output current ( $I_{OUT}$ ) is determined by device power dissipation limitations.

**Note 4:** Human Body Model, applicable std. MIL-STD-883, Method 3015.7. Machine Model, applicable std. JESD22-A115-A (ESD MM std. of JEDEC). Field-Induced Charge-Device Model, applicable std. JESD22-C101-C (ESD FICDM std. of JEDEC).

**Note 5:**  $\overline{SD}$  logic is CMOS compatible. To ensure proper logic level and to minimize power supply current,  $\overline{SD}$  should typically be less than 10% of total supply voltage away from either supply rail.

**Note 6:** Typical values represent the most likely parametric norm as determined at the time of characterization. Actual typical values may vary over time and will also depend on the application and configuration. The typical values are not tested and are not guaranteed on shipped production material.

**Note 7:** Negative input current implies current flowing out of the device.

**Note 8:** Drift determined by dividing the change in parameter at temperature extremes by the total temperature change.

**Note 9:** This parameter is guaranteed by design and/or characterization and is not tested in production.

**Note 10:** "V<sub>ID</sub>" is input differential voltage (input overdrive).

## Connection Diagram

查询 LMH6601 供应商

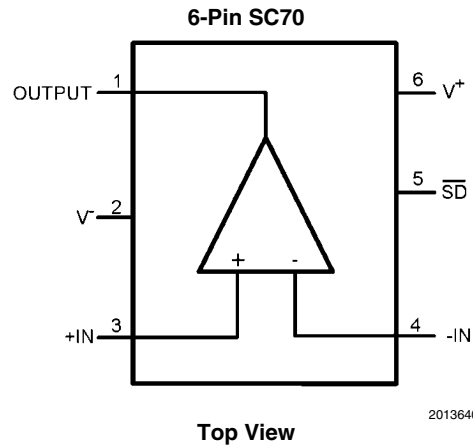

## Ordering Information

Package	Part Number	Package Marking	Transport Media	NSC Drawing	Features
6-Pin SC70	LMH6601MG	A95	1k Units Tape and Reel	MAA06A	AEC-Q100 grade 3 qualified. Automotive Grade Production Flow**
	LMH6601MGX		3k Units Tape and Reel		
	LMH6601QMG	AKA	1k Units Tape and Reel		
	LMH6601QMGX		3k Units Tape and Reel		

\*\*Automotive Grade (Q) product incorporates enhanced manufacturing and support processes for the automotive market, including defect detection methodologies. Reliability qualification is compliant with the requirements and temperature grades defined in the AEC-Q100 standard. Automotive grade products are identified with the letter Q. For more information, go to <http://www.national.com/automotive>.



# Typical Performance Characteristics

Unless otherwise noted, all data is with  $A_V = +2$ ,  $R_F = R_{IN} = 10k\Omega$ ,  $V_S = 5V$ ,  $R_S = 2k\Omega$ ,  $SD$  tied to  $V^+$ ,  $R_L = 150\Omega$  to  $V^-$ ,  $T = 25^\circ C$ .

Frequency Response for Various Output Amplitudes

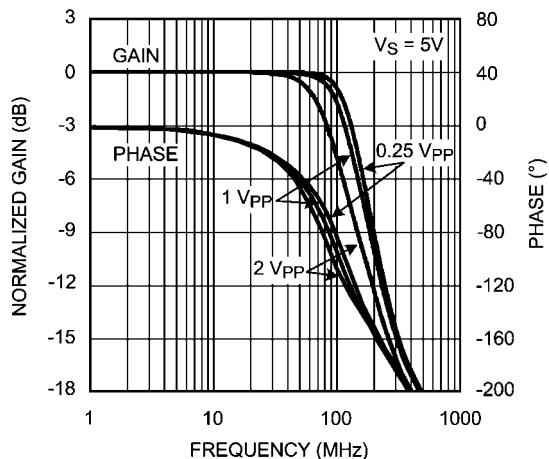

20136413

Frequency Response for Various Output Amplitudes

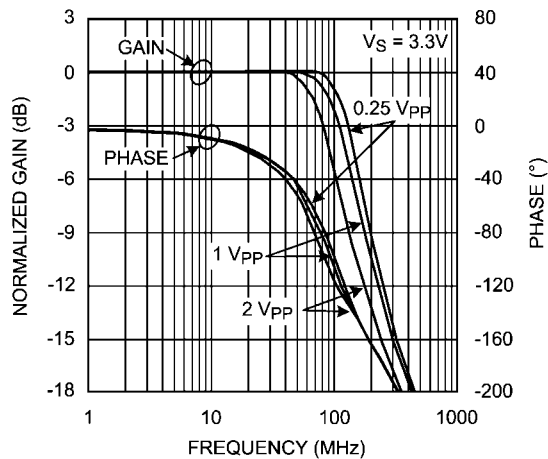

20136414

Frequency Response for Various Output Amplitudes

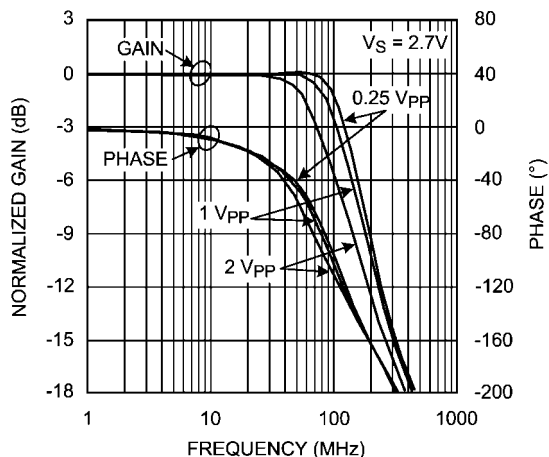

20136415

-3 dB BW vs. Supply Voltage for Various Output Swings

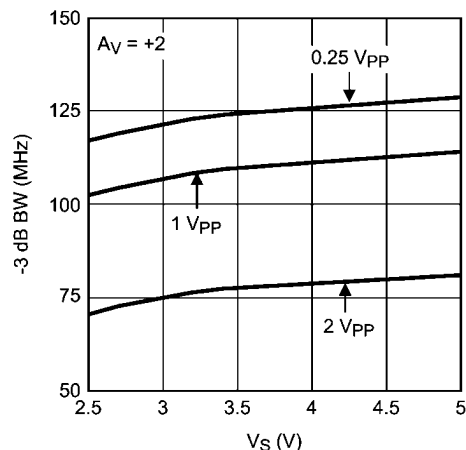

20136420

Non-inverting Frequency Response for Various Gain

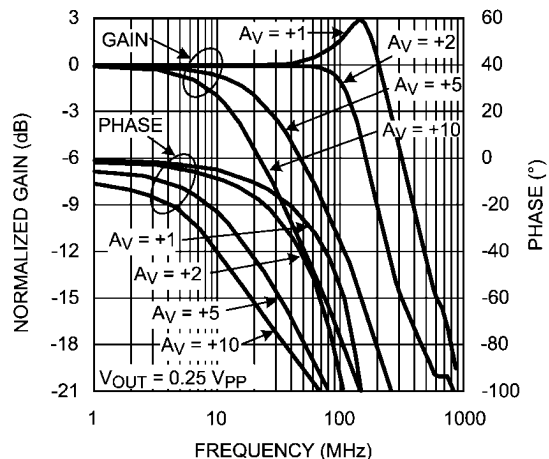

20136416

Inverting Frequency Response for Various Gain

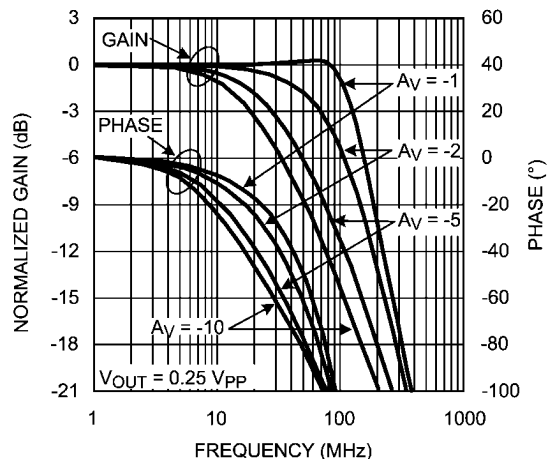

20136417

查询"LMH6601"供应商

Frequency Response for Various Loads

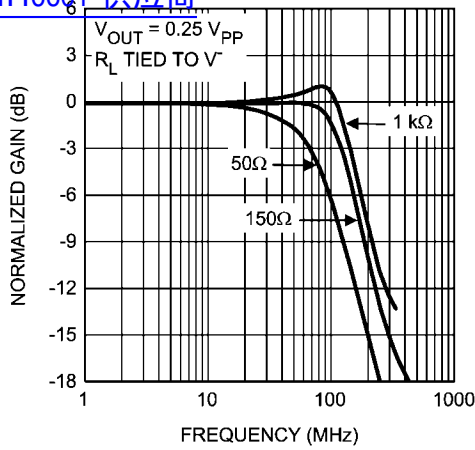

20136419

Frequency Response for Various Supply Voltages

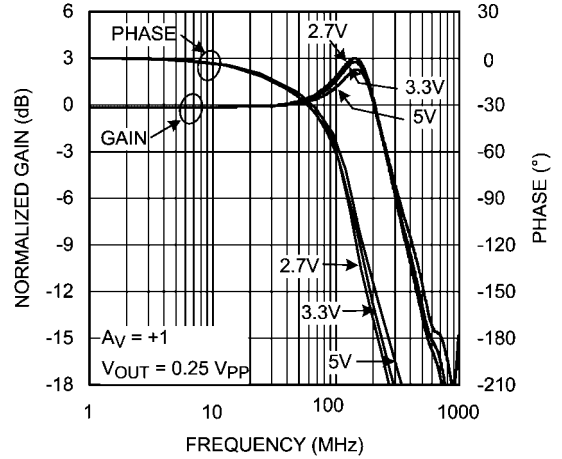

20136421

-3 dB BW vs. Ambient Temperature

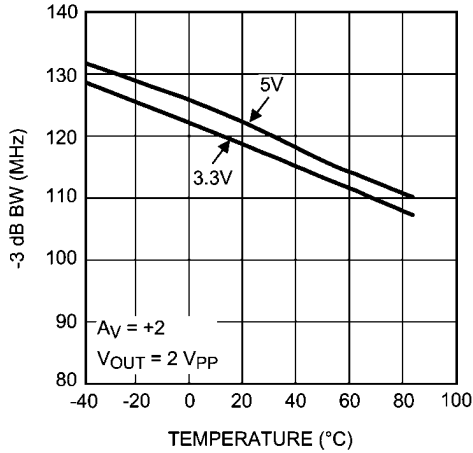

20136422

Frequency Response for Various Cap Load

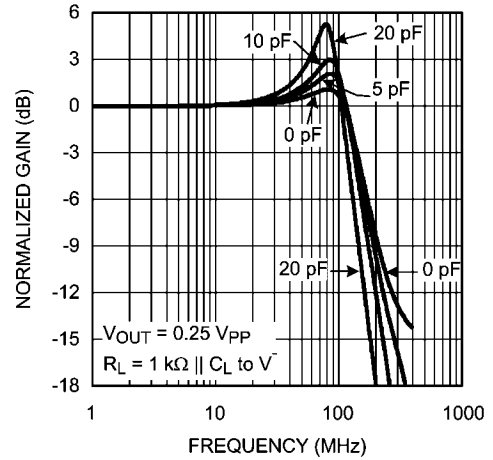

20136418

Frequency Response for Various Supply Voltage

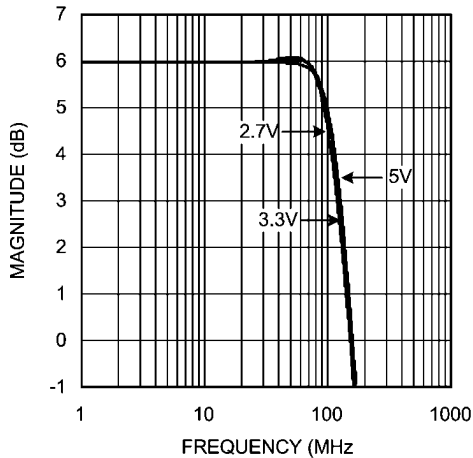

20136441

Max Output Swing vs. Frequency

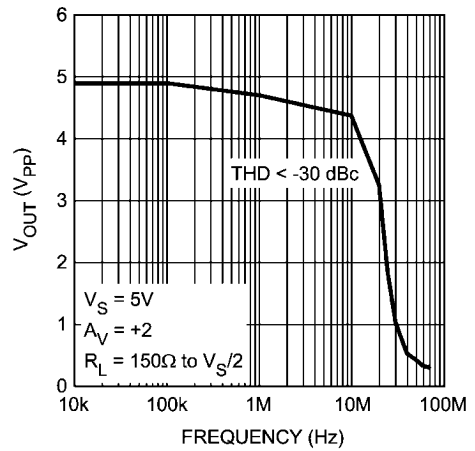

20136426

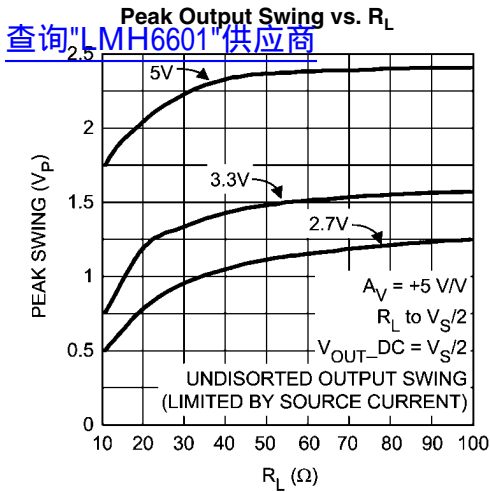

20136427

**Output Swing vs. Sink Current for Various Supply Voltages**

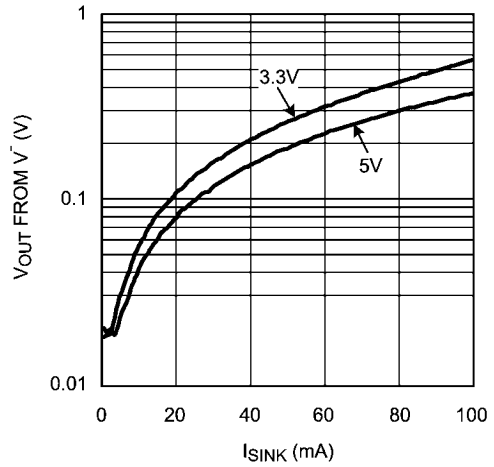

20136464

**Output Swing vs. Source Current for Various Supply Voltages**

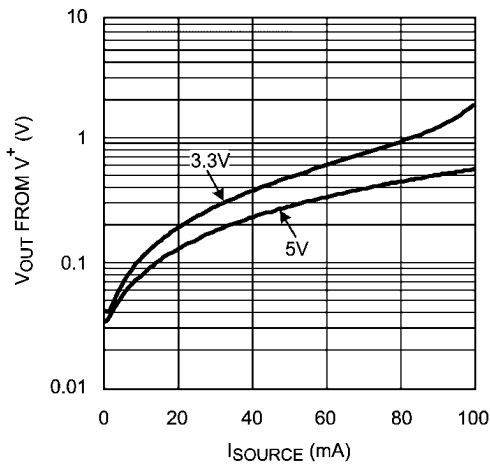

20136465

**HD2 vs. Frequency**

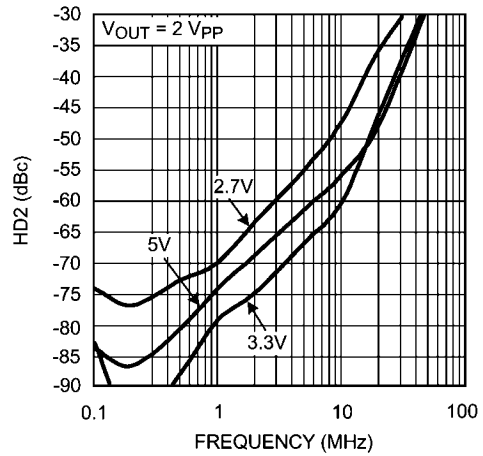

20136404

**HD3 vs. Frequency**

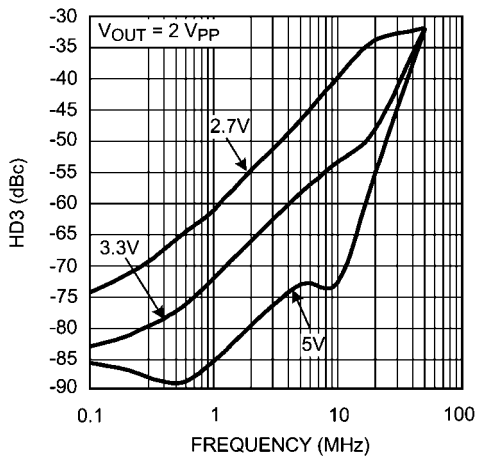

20136405

**THD vs. Output Swing**

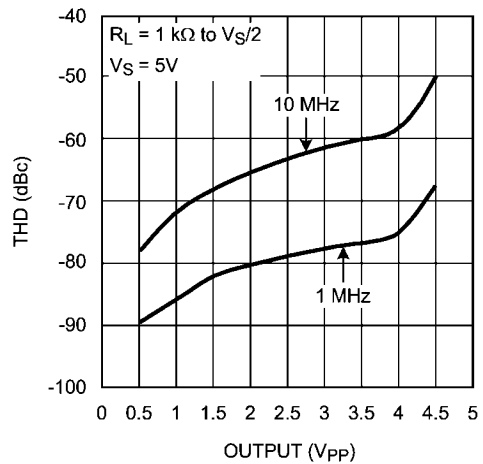

20136402

查询"LMH6601"供应商

THD vs. Output Swing

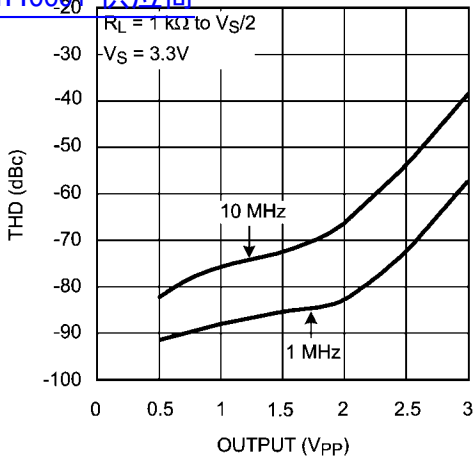

20136403

Slew Rate vs. Ambient Temperature

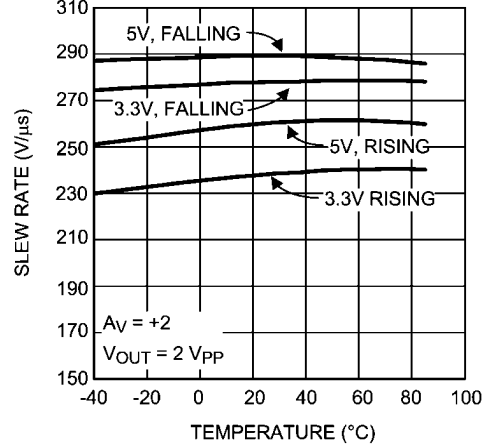

20136423

Settling Time ( $\pm 1\%$ ) vs. Output Swing

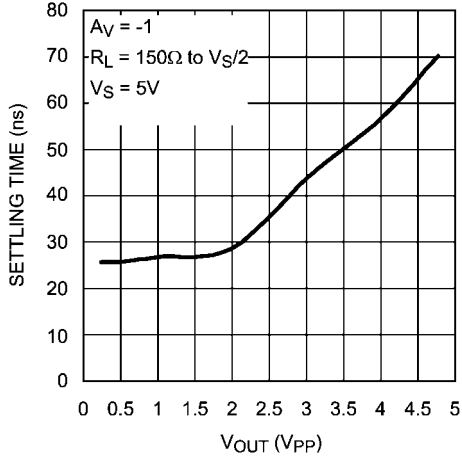

20136411

Output Settling

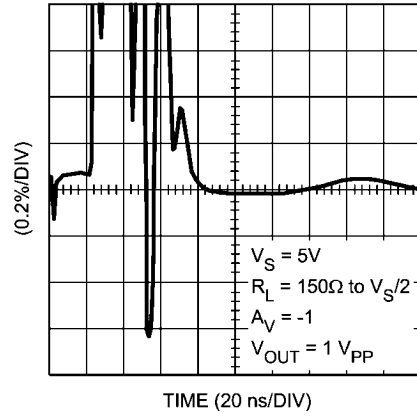

20136412

Isolation Resistor & Settling Time vs.  $C_L$

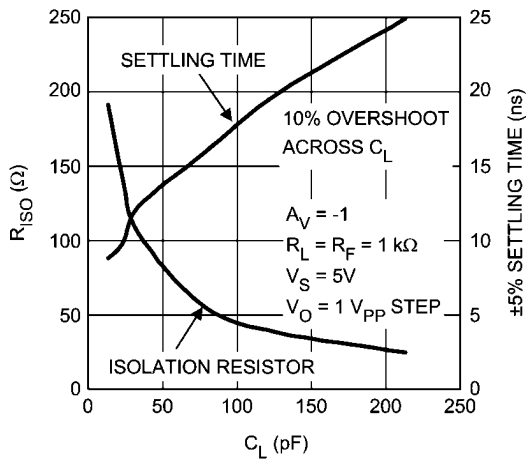

20136428

Isolation Resistor & Settling Time vs.  $C_L$

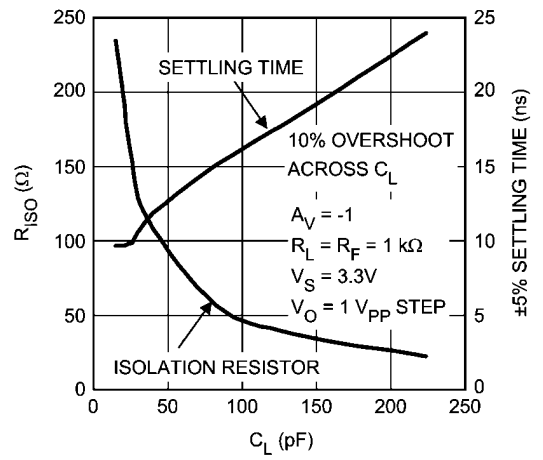

20136429

Closed Loop Output Impedance vs. Frequency for Various Supply Voltages

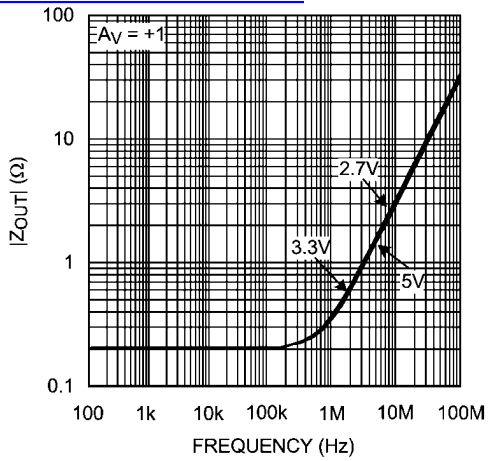

20136410

Off Isolation vs. Frequency

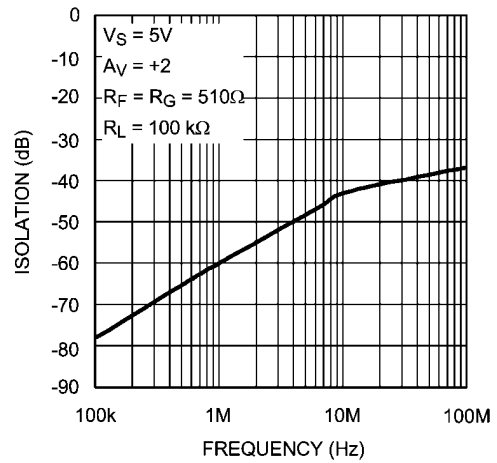

20136408

Noise Voltage vs. Frequency

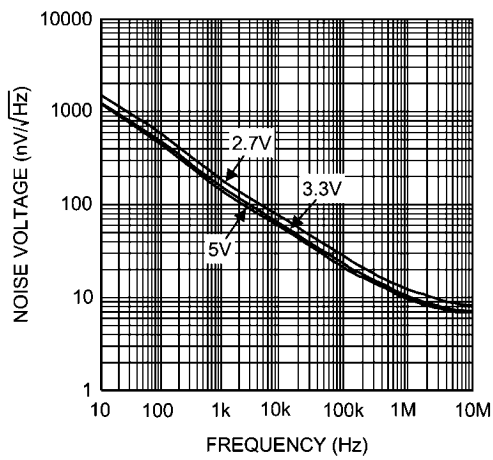

20136424

Open Loop Gain/ Phase

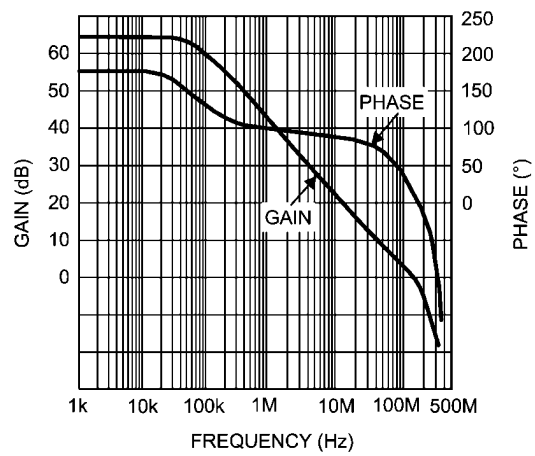

20136435

CMRR vs. Frequency

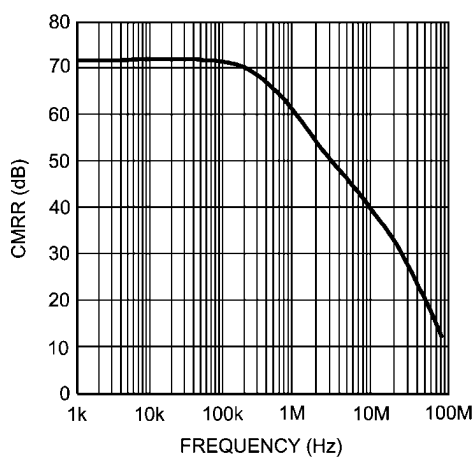

20136425

+PSRR vs. Frequency

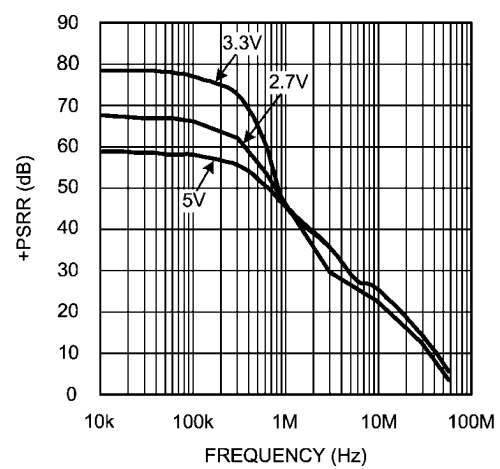

20136439

查询"LMH6601"供应商

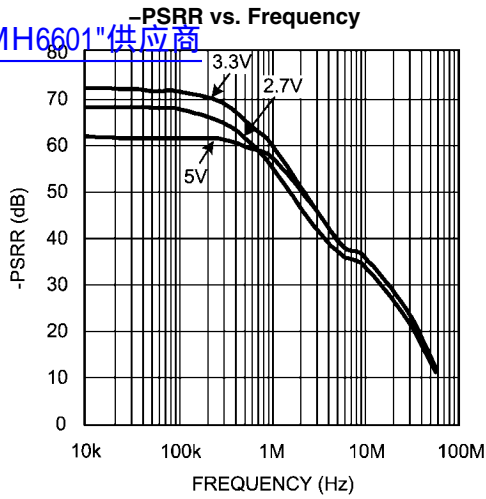

### Supply Current vs. Ambient Temperature

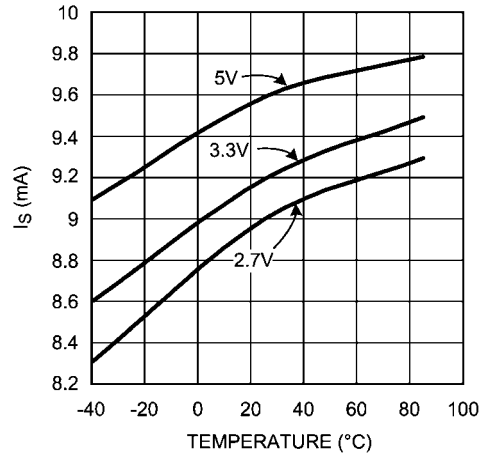

### Supply Current vs. V<sub>CM</sub>

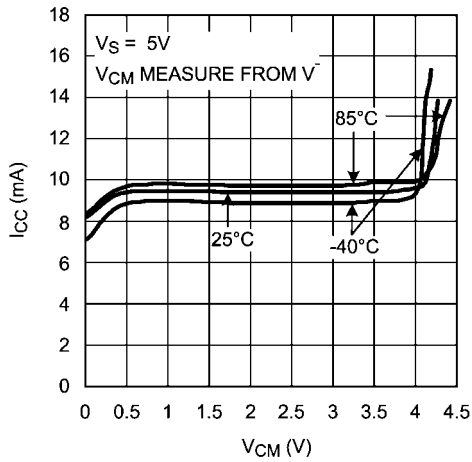

### Supply Current vs. Supply Voltage

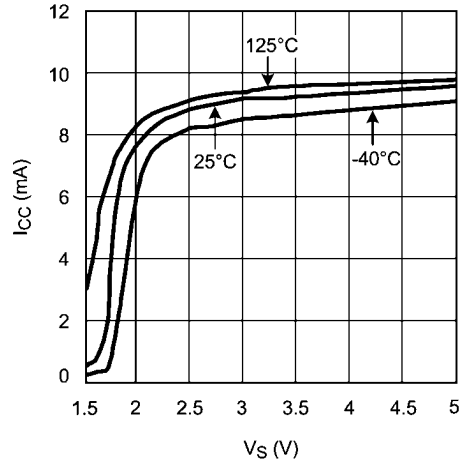

### Offset Voltage vs. Ambient Temperature for 3 Representative Units

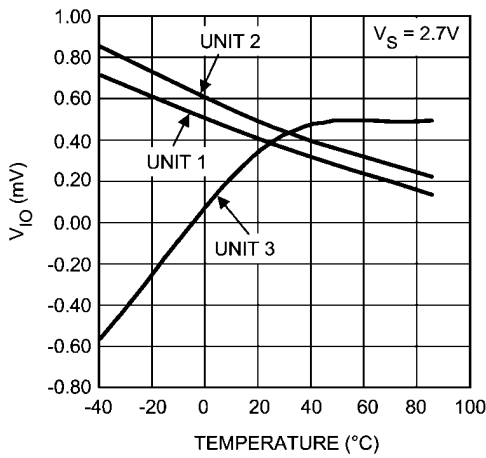

### Offset Voltage Distribution

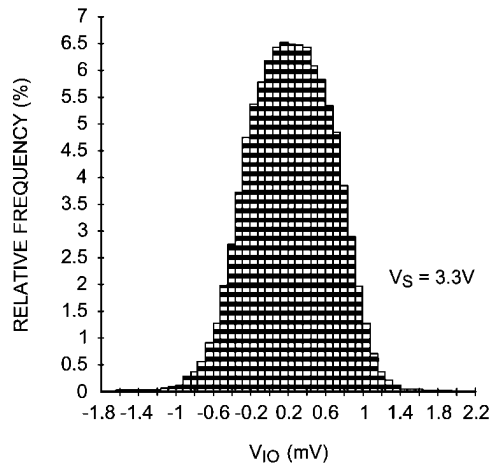

Offset Voltage vs.  $V_{CM}$  (Typical Part)

查询"LMH6601"供应商

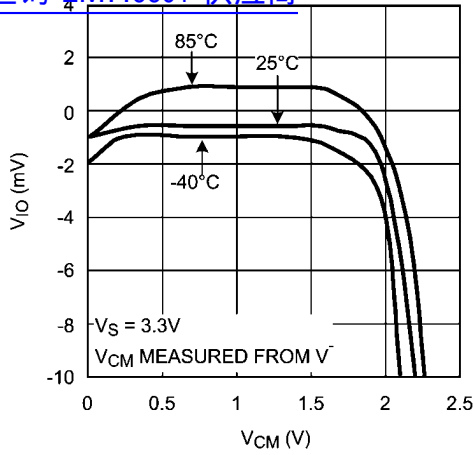

20136438

Input Bias Current vs. Common Mode Voltage

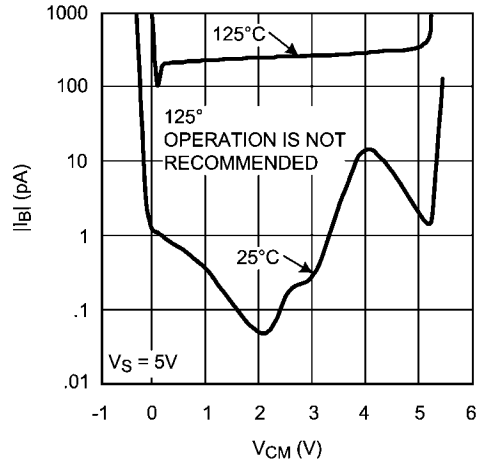

20136442

Small Signal Step Response

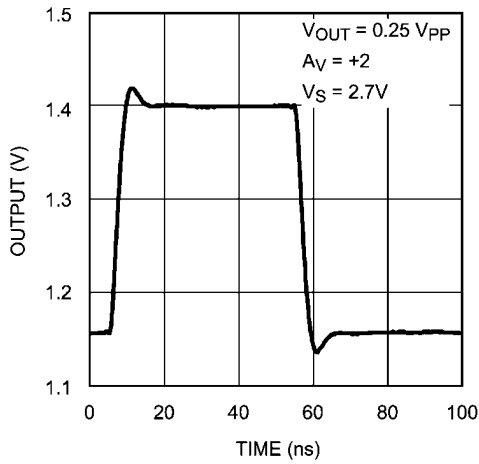

20136431

Large Signal Step Response

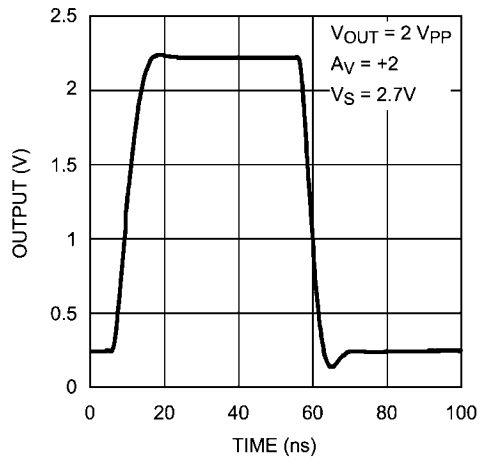

20136430

Large Signal Step Response

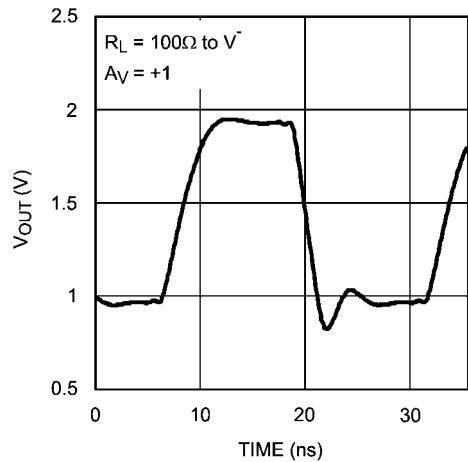

20136432

Turn On/Off Waveform

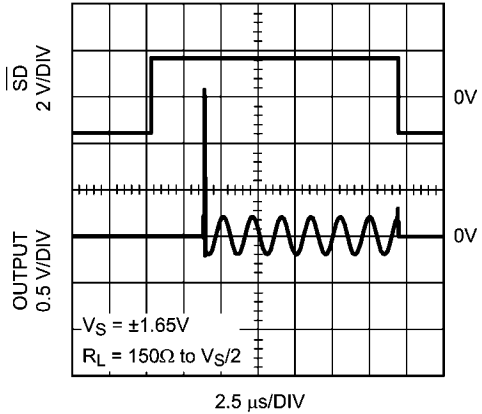

20136466

查询"LMH6601"供应商

DG vs.  $V_{OUT}$  for Various  $V_S$

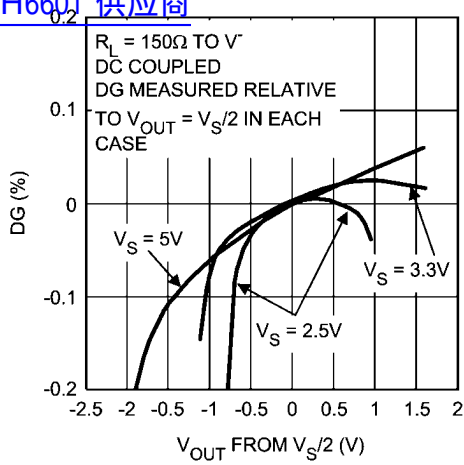

20136471

DP vs.  $V_{OUT}$  for Various  $V_S$

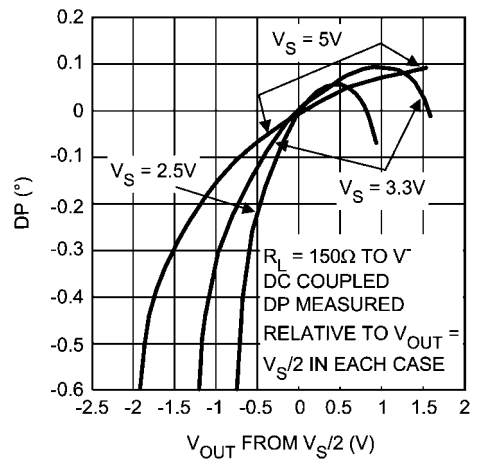

20136472

DG vs.  $V_{OUT}$  (DC and AC Coupled Load Compared)

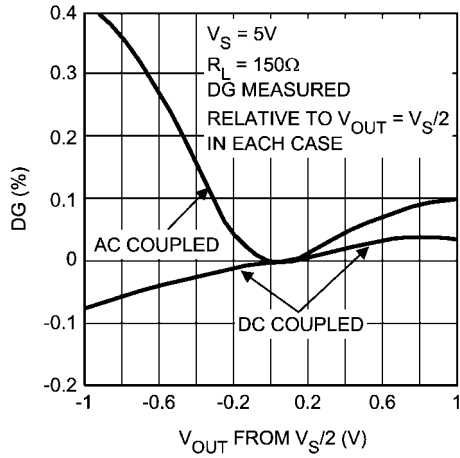

20136473

DP vs.  $V_{OUT}$  (DC and AC Coupled Load Compared)

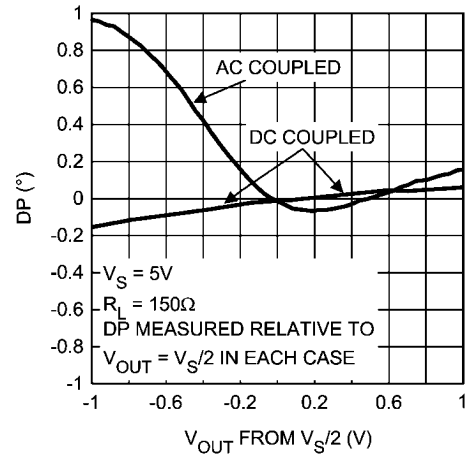

20136474



## Application Information

查询"LMH6601"供应商

### OPTIMIZING PERFORMANCE

With many op amps, additional device non-linearity and sometimes less loop stability arises when the output has to switch from current-source mode to current-sink mode or vice versa. When it comes to achieving the lowest distortion and the best Differential Gain/ Differential Phase (DG/ DP, broadcast video specs), the LMH6601 is optimized for single supply DC coupled output applications where the load current is returned to the negative rail ( $V^-$ ). That is where the output stage is most linear (lowest distortion) and which corresponds to unipolar current flowing out of this device. To that effect, it is easy to see that the distortion specifications improve when the output is only sourcing current which is the distortion-optimized mode of operation for the LMH6601. In application where the LMH6601 output is AC coupled or when it is powered by separate dual supplies for  $V^+$  and  $V^-$ , the output stage supplies both source and sink current to the load and results in less than optimum distortion (and DG/DP). *Figure 1* compares the distortion results between a DC and an AC coupled load to show the magnitude of this difference. See the DG/DP plots in the Typical Performance Characteristics section for a comparison between DC and AC coupling of the video load.

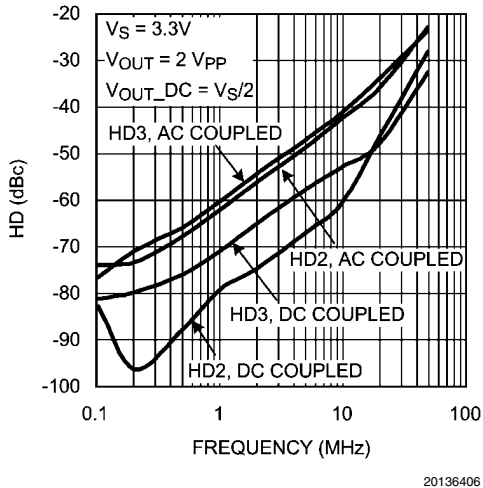

**FIGURE 1. Distortion Comparison between DC & AC Coupling of the Load**

In certain applications, it may be possible to optimize the LMH6601 for best distortion (and DG/DP) even though the load may require bipolar output current by adding a pull-down resistor to the output. Adding an output pull-down resistance of appropriate value could change the LMH6601 output loading into source-only. This comes at the price of higher total power dissipation and increased output current requirement. *Figure 2* shows how to calculate the pull-down resistor value for both the dual supply and for the AC coupled load applications.

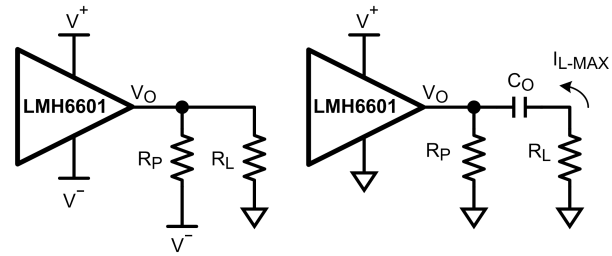

(a) DUAL SUPPLY

(b) AC COUPLED LOAD

$$R_P \leq R_L \left( \frac{V^-}{V_{O\_MIN}} - 1 \right)$$

$V_{O\_MIN}$  is the most negative swing at output

$$R_P \leq \frac{V_{O\_MIN}}{I_{L\_MAX}}$$

$V_{O\_MIN}$  is the most negative swing at output and  $I_{L\_MAX}$  is maximum load current with direction shown

20136470

**FIGURE 2. Output Pull-Down Value for Dual Supply & AC Coupling**

Furthermore, with a combination of low closed loop gain setting (i.e.  $A_V = +1$  for example where device bandwidth is the highest), light output loading ( $R_L > 1 \text{ k}\Omega$ ), and with a significant capacitive load ( $C_L > 10 \text{ pF}$ ), the LMH6601 is most stable if output sink current is kept to less than about 5 mA. The pull-down method described in *Figure 2* is applicable in these cases as well where the current that would normally be sunk by the op amp is diverted to the  $R_P$  path instead.

### SHUTDOWN CAPABILITY AND TURN ON/ OFF BEHAVIOR

With the device in shutdown mode, the output goes into high impedance ( $R_{OUT} > 100 \text{ M}\Omega$ ) mode. In this mode, the only path between the inputs and the output pin is through the external components around the device. So, for applications where there is active signal connection to the inverting input, with the LMH6601 in shutdown, the output could show signal swings due to current flow through these external components. For non-inverting amplifiers in shutdown, no output swings would occur, because of complete input-output isolation, with the exception of capacitive coupling.

For maximum power saving, the LMH6601 supply current drops to around  $0.1 \mu\text{A}$  in shutdown. All significant power consumption within the device is disabled for this purpose. Because of this, the LMH6601 turn on time is measured in micro-seconds whereas its turn off is fast (nano-seconds) as would be expected from a high speed device like this.

The LMH6601  $\overline{\text{SD}}$  pin is a CMOS compatible input with a pico-ampere range input current drive requirement. This pin needs to be tied to a level or otherwise the device state would be indeterminate. The device shutdown threshold is half way between the  $V^+$  and  $V^-$  pin potentials at any supply voltage. For example, with  $V^+$  tied to 10V and  $V^-$  equal to 5V, you can expect the threshold to be at 7.5V. The state of the device (shutdown or normal operation) is guaranteed over temperature as long as the  $\overline{\text{SD}}$  pin is held to within 10% of the total supply voltage.

For  $V^+ = 10\text{V}$ ,  $V^- = 5\text{V}$ , as an example:

- Shutdown Range  $5\text{V} \leq \overline{\text{SD}} \leq 5.5\text{V}$
- Normal Operation Range  $9.5\text{V} \leq \overline{\text{SD}} \leq 10\text{V}$

## OVERLOAD RECOVERY AND SWING CLOSE TO RAILS

查询LMH6601供应商  
The LMH6601 can recover from an output overload in less than 20 ns. See Figure 3 below for the input and output scope photos:

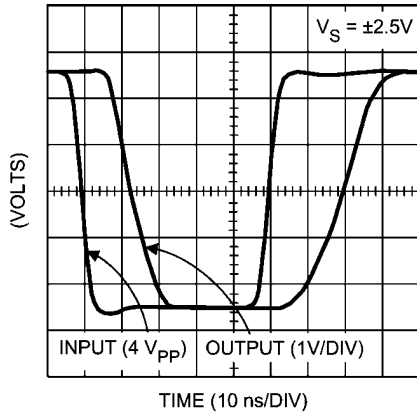

20136407

**FIGURE 3. LMH6601 Output Overload Recovery Waveform**

In Figure 3, the input step function is set so that the output is driven to one rail and then the other and then the output recovery is measured from the time the input crosses 0V to when the output reaches this point.

Also, when the LMH6601 input voltage range is exceeded near the  $V^+$  rail, the output does not experience output phase reversal, as some op amps do. This is particularly advantageous in applications where output phase reversal has to be avoided at all costs, such as in servo loop control among others. This adds to the LMH6601's set of features which make this device easy to use.

In addition, the LMH6601's output swing close to either rail is well-behaved as can be seen in the scope photo of Figure 4.

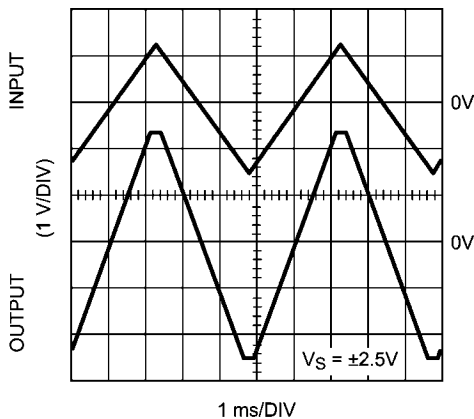

20136443

**FIGURE 4. LMH6601's "Clean" Swing to Either Rail**

With some op amps, when the output approaches either one or both rails and saturation starts to set in, there is significant increase in the transistor parasitic capacitances which leads to loss of Phase Margin. That is why with these devices, there are sometimes hints of instability with output close to the rails. With the LMH6601, as can be seen in Figure 4, the output waveform remains free of instability throughout its range of voltages.

## SINGLE SUPPLY VIDEO APPLICATION

The LMH6601's high speed and fast slew rate make it an ideal choice for video amplifier and buffering applications. There are cost benefits in having a single operating supply. Single supply video systems can take advantage of the LMH6601's low supply voltage operation along with its ability to operate with input common mode voltages at or slightly below the  $V^-$  rail. Additional cost savings can be achieved by eliminating or reducing the value of the input and output AC coupling capacitors commonly employed in single supply video applications. This Application section shows some circuit techniques used to help in doing just that.

## DC COUPLED, SINGLE SUPPLY BASEBAND VIDEO AMPLIFIER/DRIVER

The LMH6601 output can swing very close to either rail to maximize the output dynamic range which is of particular interest when operating in a low voltage single supply environment. Under light output load conditions, the output can swing as close as a few milli-volts of either rail. This also allows a video amplifier to preserve the video black level for excellent video integrity. In the example shown below in Figure 5, the baseband video output is amplified and buffered by the LMH6601 which then drives the 75Ω back terminated video cable for an overall gain of +1 delivered to the 75Ω load. The input video would normally have a level between 0V to approximately 0.75V.

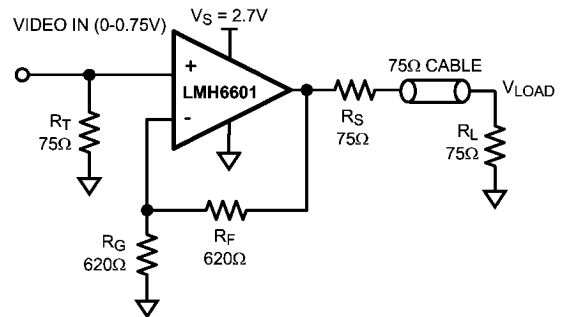

20136444

**FIGURE 5. Single Supply Video Driver Capable of Maintaining Accurate Video Black Level**

With the LMH6601 input common mode range including the V<sup>-</sup> (ground) rail, there will be no need for AC coupling or level shifting and the input can directly drive the non-inverting input which has the additional advantage of high amplifier input impedance. With LMH6601's wide rail-to-rail output swing, as stated earlier, the video black level of 0V is maintained at the load with minimal circuit complexity and using no AC coupling capacitors. Without true rail-to-rail output swing of the LMH6601, and more importantly without the LMH6601's ability of exceedingly close swing to V<sup>-</sup>, the circuit would not operate properly as shown at the expense of more complexity. This circuit will also work for higher input voltages. The only significant requirement is that there is at least 1.8V from the maximum input voltage to the positive supply (V<sup>+</sup>).

The Composite Video Output of some low cost consumer video equipment consists of a current source which develops the video waveform across a load resistor (usually 75Ω), as shown in [Figure 6](#) below. With these applications, the same circuit configuration just described and shown in [Figure 6](#) will be able to buffer and drive the Composite Video waveform which includes sync and video combined. However, with this arrangement, the LMH6601 supply voltage needs to be at least 3.3V or higher in order to allow proper input common mode voltage headroom because the input can be as high as 1V peak.

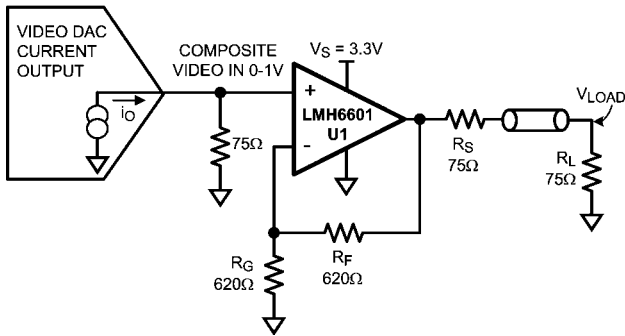

20136445

**FIGURE 6. Single Supply Composite Video Driver for Consumer Video Outputs**

If the "Video In" signal is Composite Video with negative going Sync tip, a variation of the previous configurations should be used. This circuit produces a unipolar (above 0V) DC coupled single supply video signal as shown in [Figure 7](#).

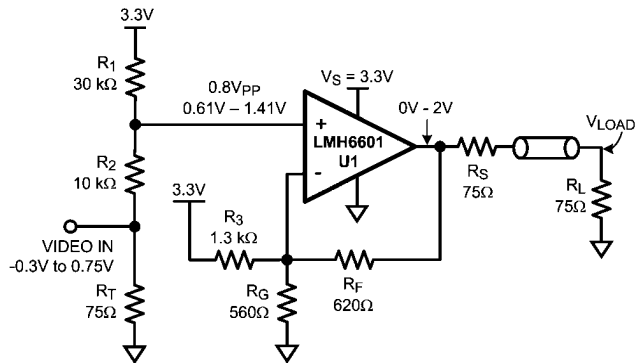

20136446

**FIGURE 7. Single Supply DC Coupled Composite Video Driver for Negative Going Sync Tip**

In the circuit of [Figure 7](#), the input is shifted positive by means of R<sub>1</sub>, R<sub>2</sub>, and R<sub>T</sub> in order to satisfy U1's Common Mode input range. The signal will lose 20% of its amplitude in the process. The closed loop gain of U1 will need to be set to make up for this 20% loss in amplitude. This gives rise to the gain expression shown below which is based on a getting a 2 V<sub>PP</sub> output with a 0.8 V<sub>PP</sub> input:

$$\frac{R_F}{R_G || R_3} = \frac{2V}{0.8V} - 1 = 1.5V/V \tag{1}$$

R<sub>3</sub> will produce a negative shift at the output due to V<sub>S</sub> (3.3V in this case). R<sub>3</sub> will need to be set so that the "Video In" sync tip (-0.3V at R<sub>T</sub> or 0.61V at U1 non-inverting input) corresponds to near 0V at the output.

$$\frac{R_F}{R_3} = \frac{0.61}{3.3V - 0.61} \left( 1 + \frac{R_F}{R_G} \right) = 0.227 \left( 1 + \frac{R_F}{R_G} \right) \tag{2}$$

[Equation 1](#) and [Equation 2](#) need to be solved simultaneously to arrive at the values of R<sub>3</sub>, R<sub>F</sub>, and R<sub>G</sub> which will satisfy both. From the datasheet, one can set R<sub>F</sub> = 620Ω to be close to the recommended value for a gain of +2. It is easier to solve for R<sub>G</sub> and R<sub>3</sub> by starting with a good estimate for one and iteratively solving [Equation 1](#) and [Equation 2](#) to arrive at the results. Here is one possible iteration cycle for reference:

**R<sub>F</sub> = 620Ω**

查询"LMH6601"供应商

TABLE 1. Finding *Figure 7* External Resistor Values by Iteration

Estimate $R_G$ ( $\Omega$ )	Calculated (from <i>Equation 2</i> ) $R_3$ ( $\Omega$ )	<i>Equation 1</i> LHS Calculated	Comment (Compare <i>Equation 1</i> LHS Calculated to RHS)
1k	1.69k	0.988	Increase <i>Equation 1</i> LHS by reducing $R_G$
820	1.56k	1.15	Increase <i>Equation 1</i> LHS by reducing $R_G$
620	1.37k	1.45	Increase <i>Equation 1</i> LHS by reducing $R_G$
390	239	4.18	Reduce <i>Equation 1</i> LHS by increasing $R_G$
<b>560</b>	<b>1.30k</b>	1.59	Close to target value of 1.5V/V for <i>Equation 1</i>

The final set of values for  $R_G$  and  $R_3$  in Table 1 are values which will result in the proper gain and correct video levels (0V to 1V) at the output ( $V_{LOAD}$ ).

### AC COUPLED VIDEO

Many monitors and displays accept AC coupled inputs. This simplifies the amplification and buffering task in some respects. As can be seen in *Figure 8*,  $R_1$  and  $R_2$  simply set the input to the center of the input linear range while  $C_{IN}$  AC couples the video onto the op amp's input. The op amp is set for a closed loop gain of 2 with  $R_F$  and  $R_G$ .  $C_G$  is there to make sure the device output is also biased at mid-supply. Because

of the DC bias at the output, the load needs to be AC coupled as well through  $C_O$ . Some applications implement a small valued ceramic capacitor (not shown) in parallel with  $C_O$  which is electrolytic. The reason for this is that the ceramic capacitor will tend to shunt the inductive behavior of the Electrolytic capacitor at higher frequencies for an improved overall low impedance output.

$C_{G2}$  is intended to boost the high frequency gain in order to improve the video frequency response. This value is to be set and trimmed on the board to meet the application's specific system requirements.

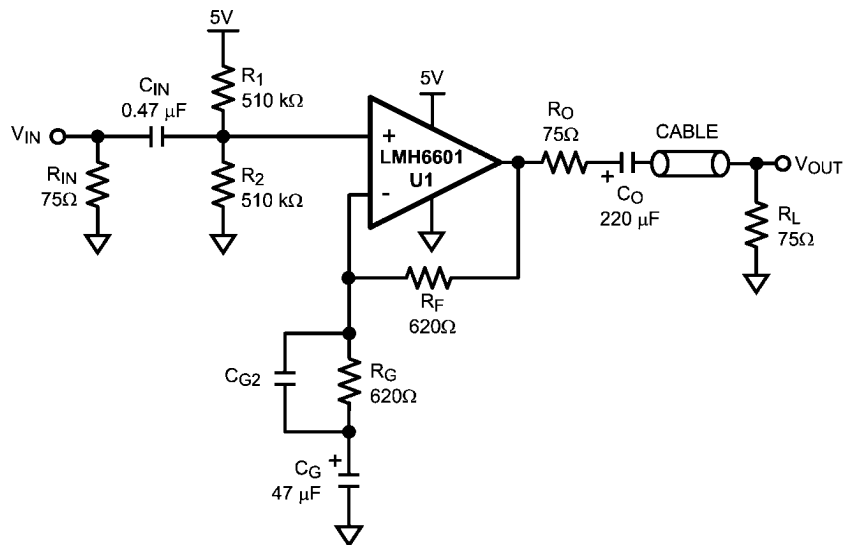

20136449

FIGURE 8. AC Coupled Video Amplifier/Driver

### SAG COMPENSATION

The capacitors shown in *Figure 8* (except  $C_{G2}$ ), and especially  $C_O$ , are the large electrolytic type which are considerably costly and take up valuable real estate on the board. It is possible to reduce the value of the output coupling capacitor,  $C_O$ , which is the largest of all, by using what is called SAG compensation. SAG refers to what the output video experiences due to the low frequency video content it contains

which cannot adequately go through the output AC coupling scheme due to the low frequency limit of this circuit. The -3 dB low frequency limit of the output circuit is given by:

$$f_{\text{low\_frequency}} (-3 \text{ dB}) = 1 / (2 * \pi * 75 * 2(\Omega) * C_O) \\ = \sim 4.82 \text{ Hz For } C_O = 220 \mu\text{F} \quad (3)$$

A possible implementation of the SAG compensation is shown in *Figure 9*.

[查询"LMH6601"供应商](#)

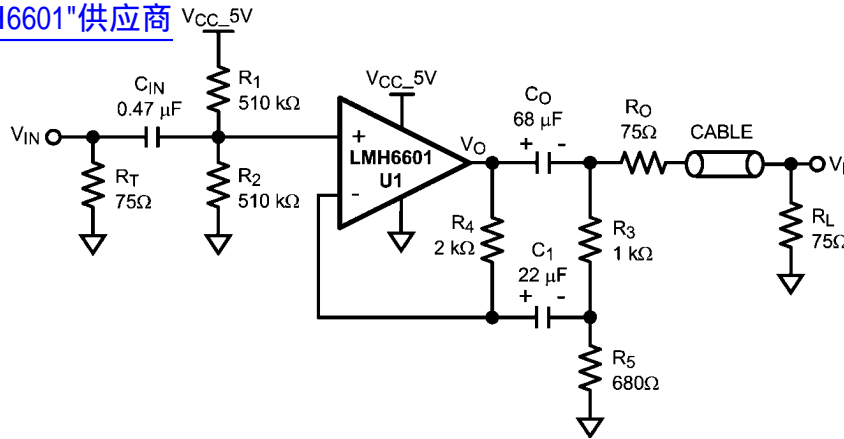

20136450

FIGURE 9. AC Coupled Video Amplifier/Driver with SAG Compensation

In this circuit, the output coupling capacitor value and size is reduced at the expense of a slightly more complicated circuitry. Note that C1 is not only part of the SAG compensation, but it also sets the amplifier's DC gain to 0 dB so that the output is set to mid-rail for linearity purposes. Also note that exceptionally high values are chosen for the R1 and R2 biasing resistors (510 kΩ). The LMH6601 has extremely low input bias current which allows this selection thereby reducing the CIN value in this circuit such that CIN can even be a non-polar capacitors which will reduce cost.

At high enough frequencies where both CO and C1 can be considered to be shorted out, R3 shunts R4 and the closed loop gain is determined by:

$$\text{Closed\_loop\_Gain (V/V)} = \frac{V_L}{V_{IN}} = \left(1 + \frac{R_3 \parallel R_4}{R_5}\right) \times \frac{R_L}{R_L + R_O} = 0.99 \text{ V/V} \quad (4)$$

At intermediate frequencies, where the CO, RO, RL path experiences low frequency gain loss, the R3, R5, C1 path provides feedback from the load side of CO. With the load side gain reduced at these lower frequencies, the feedback to the op amp inverting node reduces, causing an increase at the op amp's output as a response.

For NTSC video, low values of CO influence how much video black level shift occurs during the vertical blanking interval (~1.5 ms) which has no video activity and thus is sensitive to CO's charge dissipation through the load which could cause output SAG. An especially tough pattern is the NTSC pattern called "Pulse & Bar." With this pattern the entire top and bottom portion of the field is black level video where, for about

11 ms, CO is discharging through the load with no video activity to replenish that charge.

Figure 10 shows the output of the Figure 9 circuit highlighting the SAG.

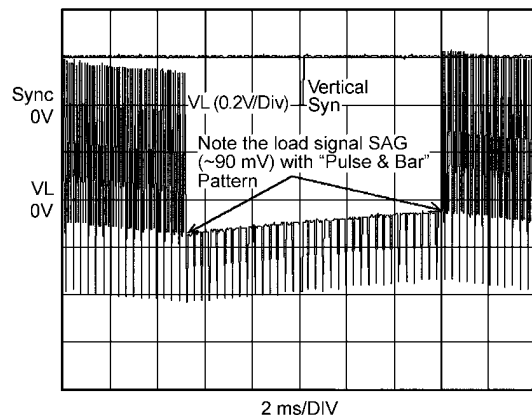

20136451

FIGURE 10. Figure 9 Scope Photo Showing Video SAG

With the circuit of Figure 9 and any other AC coupled pulse amplifier, the waveform duty cycle variations exert additional restrictions on voltage swing at any node. This is illustrated in the waveforms shown in Figure 11.

[查询"LMH6601"供应商](#)

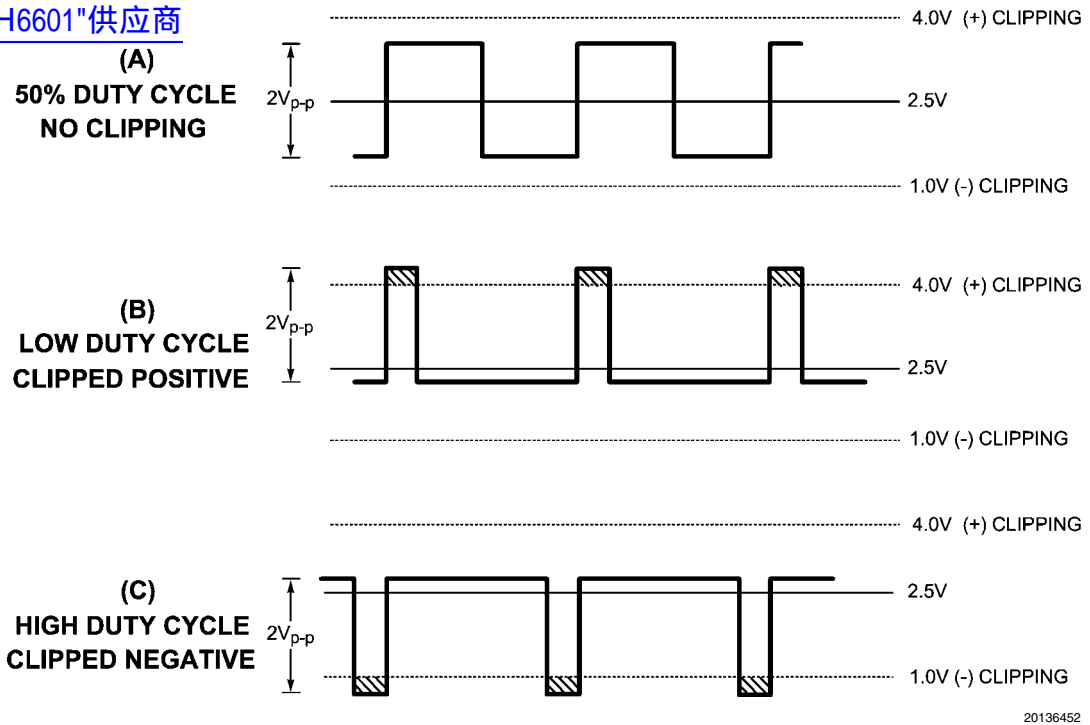

FIGURE 11. Headroom Considerations with AC Coupled Amplifiers

If a stage has a  $3 V_{PP}$  unclipped swing capability available at a given node, as shown in [Figure 11](#), the maximum allowable amplitude for an arbitrary waveform is  $\frac{1}{2}$  of  $3V$  or  $1.5 V_{PP}$ . This is due to the shift in the average value of the waveform as the duty cycle varies. [Figure 11](#) shows what would happen if a  $2 V_{PP}$  signal were applied. A low duty cycle waveform, such as the one in [Figure 11B](#), would have high positive excursions. At low enough duty cycles, the waveform could get clipped on the top, as shown, or a more subtle loss of linearity could occur prior to full-blown clipping. The converse of this occurs with high duty cycle waveforms and negative clipping, as depicted in [Figure 11C](#).

#### HOW TO PICK THE RIGHT VIDEO AMPLIFIER

Apart from output current drive and voltage swing, the op amp used for a video amplifier/cable driver should also possess the minimum requirement for speed and slew rate. For video type loads, it is best to consider Large Signal Bandwidth (or LSBW in the National Semiconductor data sheet tables) as video signals could be as large as  $2 V_{PP}$  when applied to the commonly used gain of +2 configuration. Because of this relatively large swing, the op amp Slew Rate (SR) limitation should also be considered. [Table 2](#) shows these requirements for various video line rates calculated using a rudimentary technique and intended as a first order estimate only.

TABLE 2. Rise Time, -3 dB BW, and Slew Rate Requirements for Various Video Line Rates

Video Standard	Line Rate (HxV)	Refresh Rate (Hz)	Horizontal Active (KH%)	Vertical Active (KV%)	Pixel Time (ns)	Rise Time (ns)	LSBW (MHz)	SR (V/ $\mu$ s)
TV_NTSC	451x483	30	84	92	118.3	39.4	9	41
VGA	640x480	75	80	95	33.0	11.0	32	146
SVGA	800x600	75	76	96	20.3	6.8	52	237
XGA	1024x768	75	77	95	12.4	4.1	85	387
SXGA	1280x1024	75	75	96	7.3	2.4	143	655
UXGA	1600x1200	75	74	96	4.9	1.6	213	973

For any video line rate (HxV corresponding to the number of Active lines) and a particular line rate speed requirements can be estimated if the Horizontal Active (KH%) and Vertical Active (KV%) numbers are known. These percentages correspond to the percentages of the active number of lines (horizontal or vertical) to the total number of lines as set by VESA standards. Here are the general expressions and the specific calculations for the SVGA line rate shown in [Table 2](#).

$$\begin{aligned}
 \text{PIXEL\_TIME (ns)} &= \frac{1}{\text{REFRESH\_RATE}} \times \text{KH} \times \text{KV} \times 1 \times 10^5 \\
 &= \frac{1}{75 \text{ Hz}} \times 76 \times 96 \times 1 \times 10^5 = 20.3 \text{ ns}
 \end{aligned}
 \tag{5}$$

Requiring that an “On” pixel is illuminated to at least 90% of its final value before changing state will result in the rise/fall time equal to, at most, the pixel time as shown below:

$$\text{RISE/FALL\_TIME} = \frac{\text{PIXEL\_TIME}}{3} = \frac{20.3 \text{ ns}}{3} = 6.8 \text{ ns}
 \tag{6}$$

Assuming a single pole frequency response roll-off characteristic for the closed loop amplifier used, we have:

$$-3 \text{ dB\_BW} = \frac{0.35}{\text{RISE/FALL\_TIME}} = \frac{0.35}{6.8 \text{ ns}} = 52 \text{ MHz}
 \tag{7}$$

Rise/Fall times are 10%-90% transition times, which for a 2 V<sub>PP</sub> video step would correspond to a total voltage shift of 1.6V (80% of 2V). So, the Slew Rate requirement can be calculated as follows:

$$\text{SR(V/}\mu\text{s)} = \frac{1.6\text{V}}{\text{RISE/FALL\_TIME (ns)} \times 1 \times 10^3} = \frac{1.6\text{V}}{6.8 \text{ ns}} = 237(\text{V}/\mu\text{s})
 \tag{8}$$

The LMH6601 specifications show that it would be a suitable choice for video amplifiers up to and including the SVGA line rate as demonstrated above.

For more information about this topic and others relating to video amplifiers, please see Application Note 1013:

<http://www.national.com/an/AN/AN-1013.pdf#page=1>

### CURRENT TO VOLTAGE CONVERSION (TRANSIMPEDANCE AMPLIFIER (TIA))

Being capable of high speed and having ultra low input bias current makes the LMH6601 a natural choice for Current to Voltage applications such as photodiode I-V conversion. In these type of applications, as shown in [Figure 12](#) below, the photodiode is tied to the inverting input of the amplifier with R<sub>F</sub> set to the proper gain (gain is measured in Ohms).

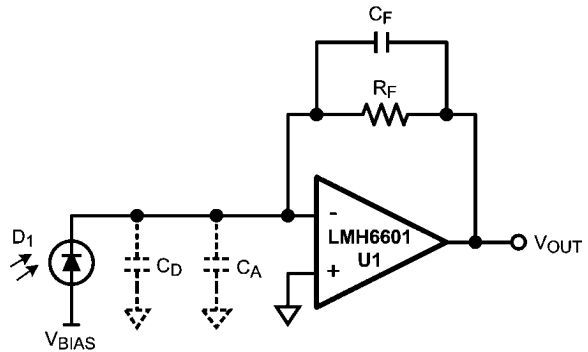

20136458

**FIGURE 12. Typical Connection of a Photodiode Detector to an op amp**

With the LMH6601 input bias current in the femto-amperes range, even large values of gain (R<sub>F</sub>) do not increase the output error term appreciably. This allows circuit operation to a lower light intensity level which is always of special importance in these applications. Most photo-diodes have a relatively large capacitance (C<sub>D</sub>) which would be even larger for a photo-diode designed for higher sensitivity to light because of its larger area. Some applications may run the photodiode with a reverse bias in order to reduce its capacitance with the disadvantage of increased contributions from both dark current and noise current. [Figure 13](#) shows a typical photodiode capacitance plot vs. reverse bias for reference.

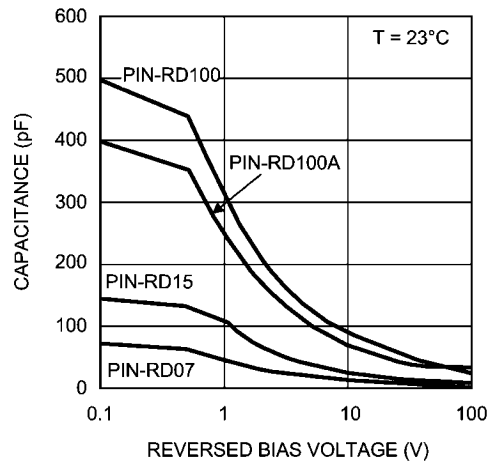

20136459

**FIGURE 13. Typical Capacitance vs. Reverse Bias (Source: OSI Optoelectronics)**

查询 LMH6601 供应商

The diode capacitance ( $C_D$ ) along with the input capacitance of the LMH6601 ( $C_{IN}$ ) has bearing on the stability of this circuit and how it is compensated. With large transimpedance gain values ( $R_F$ ), the total combined capacitance on the amplifier inverting input ( $C_{IN} = C_D + C_A$ ) will work against  $R_F$  to create a zero in the Noise Gain (NG) function (see [Figure 14](#)). If left untreated, at higher frequencies where NG equals the open loop transfer function there will be excess phase shift around the loop (approaching 180°) and therefore, the circuit could be unstable. This is illustrated in [Figure 14](#).

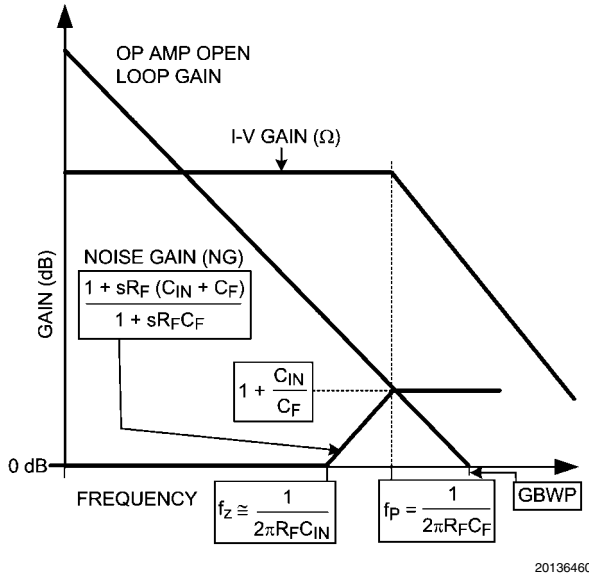

**FIGURE 14. Transimpedance Amplifier Graphical Stability Analysis and Compensation**

**TABLE 3. Transimpedance Amplifier [Figure 12](#) Compensation and Performance Results**

$C_D$ (pF)	$C_{IN}$ (pF)	$C_F$ Calculated (pF)	$C_F$ used (pF)	-3 dB BW Calculated (MHz)	-3 dB BW Measured (MHz)	Step Response Overshoot (%)
10	12	1.1	1	14	15	6
50	52	2.3	3	7	7.0	4
500	502	7.2	8	2	2.5	9

$C_A = 2$  pF  
 $GBWP = 155$  MHz  
 $V_S = 5$  V

[Figure 14](#) shows that placing a capacitor,  $C_F$ , with the proper value, across  $R_F$  will create a pole in the NG function at  $f_p$ . For optimum performance, this capacitor is usually picked so that NG is equal to the op amp's open loop gain at  $f_p$ . This will cause a "flattening" of the NG slope beyond the point of intercept of the two plots (open loop gain and NG) and will result in a Phase Margin (PM) of 45° assuming  $f_p$  and  $f_z$  are at least a decade apart. This is because at the point of intercept, the NG pole at  $f_p$  will have a 45° phase lead contribution which leaves 45° of PM. For reference, [Figure 14](#) also shows the transimpedance gain (I-V ( $\Omega$ ))

Here is the theoretical expression for the optimum  $C_F$  value and the expected -3 dB bandwidth:

$$C_F = \sqrt{\frac{C_{IN}}{2\pi(GBWP)R_F}} \tag{9}$$

$$f_{.3\text{ dB}} \cong \sqrt{\frac{GBWP}{2\pi R_F C_{IN}}} \tag{10}$$

[Table 3](#), below, lists the results, along with the assumptions and conditions, of testing the LMH6601 with various photodiodes having different capacitances ( $C_D$ ) at a transimpedance gain ( $R_F$ ) of 10 k $\Omega$ .



## TRANSIMPEDANCE AMPLIFIER NOISE

### CONSIDERATIONS

When analyzing the noise at the output of the I-V converter, it is important to note that the various noise sources (i.e. op amp noise voltage, feedback resistor thermal noise, input noise current, photodiode noise current) do not all operate over the same frequency band. Therefore, when the noise at the output is calculated, this should be taken into account.

The op amp noise voltage will be gained up in the region between the noise gain's "zero" and its "pole" ( $f_z$  and  $f_p$  in [Figure 14](#)). The higher the values of  $R_F$  and  $C_{IN}$ , the sooner the noise gain peaking starts and therefore its contribution to the total output noise would be larger. It is obvious to note that it is advantageous to minimize  $C_{IN}$  (e.g. by proper choice of op amp, by applying a reverse bias across the diode at the expense of excess dark current and noise). However, most low noise op amps have a higher input capacitance compared to ordinary op amps. This is due to the low noise op amp's larger input stage.

### OTHER APPLICATIONS

$$R_F = 10 \text{ M}\Omega \text{ to } 10 \text{ G}\Omega$$

$$R_S = 1 \text{ M}\Omega \text{ or SMALLER FOR HIGH COUNTING RATES}$$

$$C_F = 1 \text{ pF}$$

$$C_D = 1 \text{ pF to } 10 \text{ }\mu\text{F}$$

$$V_{OUT} = Q/C_F \text{ WHERE } Q \text{ IS CHARGE}$$

$$\text{CREATED BY ONE PHOTON or PARTICLE}$$

$$\text{ADJUST } V_{BIAS} \text{ FOR MAXIMUM SNR}$$

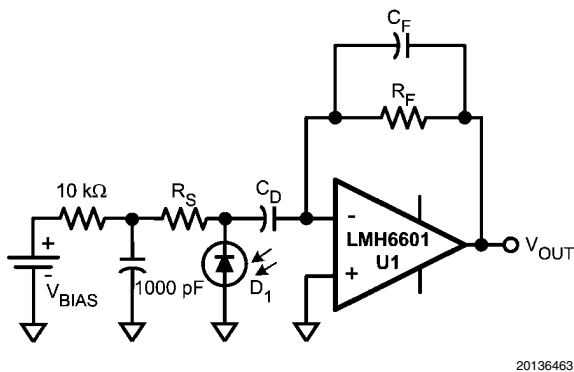

20136463

**FIGURE 15. Charge Preamplifier Taking Advantage of LMH6601's Femto-Ampere Range Input Bias Current**

### CAPACITIVE LOAD

The LMH6601 can drive a capacitive load of up to 1000 pF with correct isolation and compensation. [Figure 16](#) illustrates the in-loop compensation technique to drive a large capacitive load.

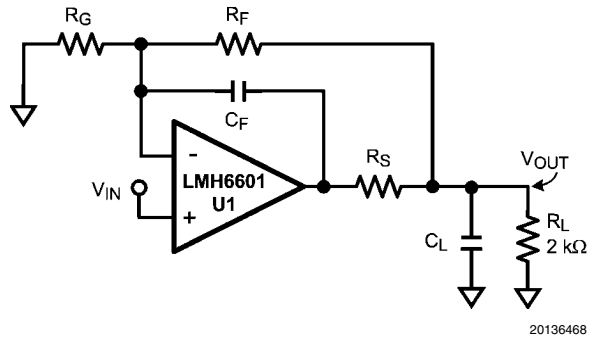

20136468

**FIGURE 16. In-Loop Compensation Circuit for Driving a Heavy Capacitive Load**

When driving a high capacitive load, an isolation resistor ( $R_S$ ) should be connected in series between the op amp output and the capacitive load to provide isolation and to avoid oscillations. A small value capacitor ( $C_F$ ) is inserted between the op amp output and the inverting input as shown such that this capacitor becomes the dominant feedback path at higher frequency. Together these components allow heavy capacitive loading while keeping the loop stable.

There are few factors which affect the driving capability of the op amp:

- Op amp internal architecture
- Closed loop gain and output capacitor loading

[Table 4](#) shows the measured step response for various values of load capacitors ( $C_L$ ), series resistor ( $R_S$ ) and feedback resistor ( $C_F$ ) with gain of +2 ( $R_F = R_G = 604\Omega$ ) and  $R_L = 2 \text{ k}\Omega$ :

**TABLE 4. LMH6601 Step Response Summary for the Circuit of [Figure 16](#)**

$C_L$ (pF)	$R_S$ ( $\Omega$ )	$C_F$ (pF)	$t_{rise}/t_{fall}$ (ns)	Overshoot (%)
10	0	1	6*	8
50	0	1	7*	6
110	47	1	10	16
300	6	10	12	20
500	80	10	33	10
910	192	10	65	10

\* Response limited by input step generator rise time of 5 ns

[Figure 17](#) shows the increase in rise/fall time (bandwidth decrease) at  $V_{OUT}$  with larger capacitive loads, illustrating the trade-off between the two:

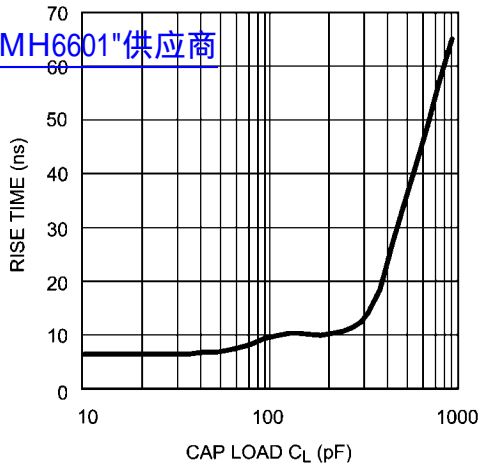
[查询"LMH6601"供应商](#)

20136469

**FIGURE 17. LMH6601 In-Loop Compensation Response****EVALUATION BOARD**

National Semiconductor provides the following evaluation board as a guide for high frequency layout and as an aid in device testing and characterization. Many of the datasheet plots were measured with this board:

Device	Package	Board Part #
LMH6601MG	SC70-6	LMH730165

This evaluation board can be shipped when a device sample request is placed with National Semiconductor.

**Physical Dimensions** inches (millimeters) unless otherwise noted  
[查询"LMH6601"供应商](#)

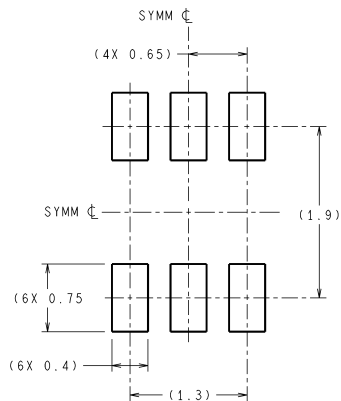
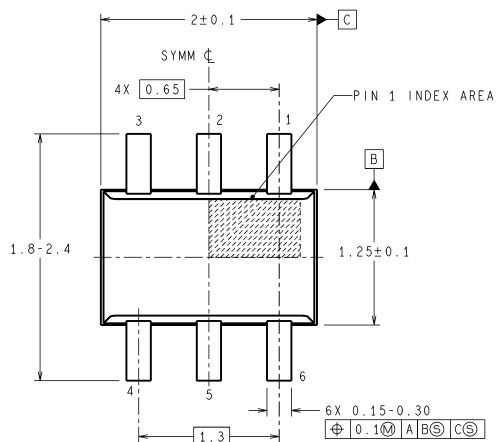

LAND PATTERN RECOMMENDATION

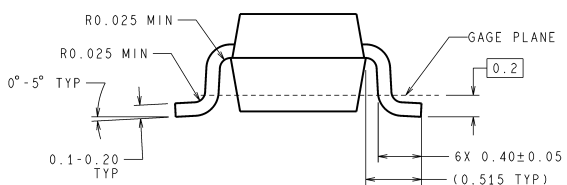
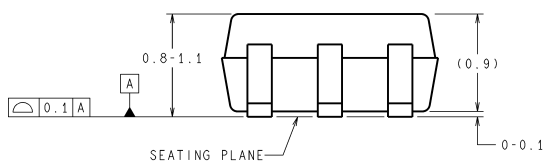

DIMENSIONS ARE IN MILLIMETERS  
 DIMENSIONS IN ( ) FOR REFERENCE ONLY

MAA06A (Rev B)

**6-Pin SC70**  
**NS Package Number MA006A**

[查询"LMH6601"供应商](#)

## Notes

For more National Semiconductor product information and proven design tools, visit the following Web sites at:

Products		Design Support	
Amplifiers	<a href="http://www.national.com/amplifiers">www.national.com/amplifiers</a>	WEBENCH® Tools	<a href="http://www.national.com/webench">www.national.com/webench</a>
Audio	<a href="http://www.national.com/audio">www.national.com/audio</a>	App Notes	<a href="http://www.national.com/appnotes">www.national.com/appnotes</a>
Clock and Timing	<a href="http://www.national.com/timing">www.national.com/timing</a>	Reference Designs	<a href="http://www.national.com/refdesigns">www.national.com/refdesigns</a>
Data Converters	<a href="http://www.national.com/adc">www.national.com/adc</a>	Samples	<a href="http://www.national.com/samples">www.national.com/samples</a>
Interface	<a href="http://www.national.com/interface">www.national.com/interface</a>	Eval Boards	<a href="http://www.national.com/evalboards">www.national.com/evalboards</a>
LVDS	<a href="http://www.national.com/lvds">www.national.com/lvds</a>	Packaging	<a href="http://www.national.com/packaging">www.national.com/packaging</a>
Power Management	<a href="http://www.national.com/power">www.national.com/power</a>	Green Compliance	<a href="http://www.national.com/quality/green">www.national.com/quality/green</a>
Switching Regulators	<a href="http://www.national.com/switchers">www.national.com/switchers</a>	Distributors	<a href="http://www.national.com/contacts">www.national.com/contacts</a>
LDOs	<a href="http://www.national.com/ldo">www.national.com/ldo</a>	Quality and Reliability	<a href="http://www.national.com/quality">www.national.com/quality</a>
LED Lighting	<a href="http://www.national.com/led">www.national.com/led</a>	Feedback/Support	<a href="http://www.national.com/feedback">www.national.com/feedback</a>
Voltage Reference	<a href="http://www.national.com/vref">www.national.com/vref</a>	Design Made Easy	<a href="http://www.national.com/easy">www.national.com/easy</a>
PowerWise® Solutions	<a href="http://www.national.com/powerwise">www.national.com/powerwise</a>	Solutions	<a href="http://www.national.com/solutions">www.national.com/solutions</a>
Serial Digital Interface (SDI)	<a href="http://www.national.com/sdi">www.national.com/sdi</a>	Mil/Aero	<a href="http://www.national.com/milaero">www.national.com/milaero</a>
Temperature Sensors	<a href="http://www.national.com/tempensors">www.national.com/tempensors</a>	SolarMagic™	<a href="http://www.national.com/solarmagic">www.national.com/solarmagic</a>
Wireless (PLL/VCO)	<a href="http://www.national.com/wireless">www.national.com/wireless</a>	PowerWise® Design University	<a href="http://www.national.com/training">www.national.com/training</a>

THE CONTENTS OF THIS DOCUMENT ARE PROVIDED IN CONNECTION WITH NATIONAL SEMICONDUCTOR CORPORATION ("NATIONAL") PRODUCTS. NATIONAL MAKES NO REPRESENTATIONS OR WARRANTIES WITH RESPECT TO THE ACCURACY OR COMPLETENESS OF THE CONTENTS OF THIS PUBLICATION AND RESERVES THE RIGHT TO MAKE CHANGES TO SPECIFICATIONS AND PRODUCT DESCRIPTIONS AT ANY TIME WITHOUT NOTICE. NO LICENSE, WHETHER EXPRESS, IMPLIED, ARISING BY ESTOPPEL OR OTHERWISE, TO ANY INTELLECTUAL PROPERTY RIGHTS IS GRANTED BY THIS DOCUMENT.

TESTING AND OTHER QUALITY CONTROLS ARE USED TO THE EXTENT NATIONAL DEEMS NECESSARY TO SUPPORT NATIONAL'S PRODUCT WARRANTY. EXCEPT WHERE MANDATED BY GOVERNMENT REQUIREMENTS, TESTING OF ALL PARAMETERS OF EACH PRODUCT IS NOT NECESSARILY PERFORMED. NATIONAL ASSUMES NO LIABILITY FOR APPLICATIONS ASSISTANCE OR BUYER PRODUCT DESIGN. BUYERS ARE RESPONSIBLE FOR THEIR PRODUCTS AND APPLICATIONS USING NATIONAL COMPONENTS. PRIOR TO USING OR DISTRIBUTING ANY PRODUCTS THAT INCLUDE NATIONAL COMPONENTS, BUYERS SHOULD PROVIDE ADEQUATE DESIGN, TESTING AND OPERATING SAFEGUARDS.

EXCEPT AS PROVIDED IN NATIONAL'S TERMS AND CONDITIONS OF SALE FOR SUCH PRODUCTS, NATIONAL ASSUMES NO LIABILITY WHATSOEVER, AND NATIONAL DISCLAIMS ANY EXPRESS OR IMPLIED WARRANTY RELATING TO THE SALE AND/OR USE OF NATIONAL PRODUCTS INCLUDING LIABILITY OR WARRANTIES RELATING TO FITNESS FOR A PARTICULAR PURPOSE, MERCHANTABILITY, OR INFRINGEMENT OF ANY PATENT, COPYRIGHT OR OTHER INTELLECTUAL PROPERTY RIGHT.

### LIFE SUPPORT POLICY

**NATIONAL'S PRODUCTS ARE NOT AUTHORIZED FOR USE AS CRITICAL COMPONENTS IN LIFE SUPPORT DEVICES OR SYSTEMS WITHOUT THE EXPRESS PRIOR WRITTEN APPROVAL OF THE CHIEF EXECUTIVE OFFICER AND GENERAL COUNSEL OF NATIONAL SEMICONDUCTOR CORPORATION.** As used herein:

Life support devices or systems are devices which (a) are intended for surgical implant into the body, or (b) support or sustain life and whose failure to perform when properly used in accordance with instructions for use provided in the labeling can be reasonably expected to result in a significant injury to the user. A critical component is any component in a life support device or system whose failure to perform can be reasonably expected to cause the failure of the life support device or system or to affect its safety or effectiveness.

National Semiconductor and the National Semiconductor logo are registered trademarks of National Semiconductor Corporation. All other brand or product names may be trademarks or registered trademarks of their respective holders.

Copyright© 2009 National Semiconductor Corporation

For the most current product information visit us at [www.national.com](http://www.national.com)



**National Semiconductor Americas Technical Support Center**  
Email: [support@nsc.com](mailto:support@nsc.com)  
Tel: 1-800-272-9959

**National Semiconductor Europe Technical Support Center**  
Email: [europe.support@nsc.com](mailto:europe.support@nsc.com)

**National Semiconductor Asia Pacific Technical Support Center**  
Email: [ap.support@nsc.com](mailto:ap.support@nsc.com)

**National Semiconductor Japan Technical Support Center**  
Email: [jpn.feedback@nsc.com](mailto:jpn.feedback@nsc.com)