

# 2SC3871

查询"2SC3871"供应商

## Silicon NPN triple diffusion planar type

For high breakdown voltage high-speed switching

### Features

- High-speed switching
- High collector to base voltage  $V_{CBO}$
- Wide area of safe operation (ASO)
- Full-pack package which can be installed to the heat sink with one screw

### Absolute Maximum Ratings ( $T_C=25^\circ\text{C}$ )

Parameter	Symbol	Ratings	Unit	
Collector to base voltage	$V_{CBO}$	500	V	
Collector to emitter voltage	$V_{CES}$	500	V	
	$V_{CEO}$	400	V	
Emitter to base voltage	$V_{EBO}$	7	V	
Peak collector current	$I_{CP}$	20	A	
Collector current	$I_C$	10	A	
Base current	$I_B$	5	A	
Collector power dissipation	$P_C$	$T_C=25^\circ\text{C}$	45	W
		$T_a=25^\circ\text{C}$	2	
Junction temperature	$T_j$	150	$^\circ\text{C}$	
Storage temperature	$T_{stg}$	-55 to +150	$^\circ\text{C}$	

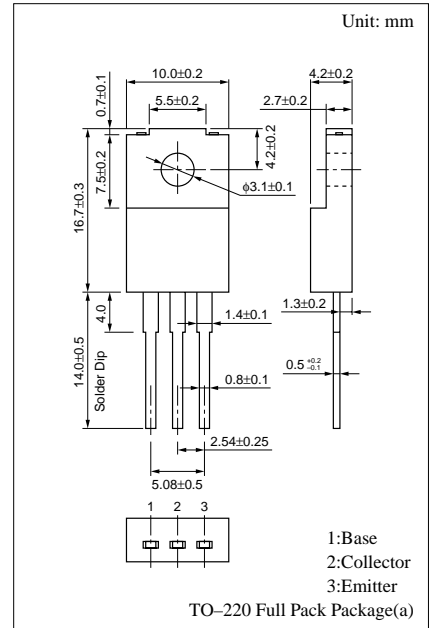

### Electrical Characteristics ( $T_C=25^\circ\text{C}$ )

Parameter	Symbol	Conditions	min	typ	max	Unit
Collector cutoff current	$I_{CBO}$	$V_{CB} = 500\text{V}, I_E = 0$			100	$\mu\text{A}$
Emitter cutoff current	$I_{EBO}$	$V_{EB} = 5\text{V}, I_C = 0$			100	$\mu\text{A}$
Collector to emitter voltage	$V_{CEO}$	$I_C = 10\text{mA}, I_B = 0$	400			V
Forward current transfer ratio	$h_{FE1}$	$V_{CE} = 5\text{V}, I_C = 0.1\text{A}$	15			
	$h_{FE2}$	$V_{CE} = 5\text{V}, I_C = 5\text{A}$	8			
Collector to emitter saturation voltage	$V_{CE(sat)}$	$I_C = 5\text{A}, I_B = 1\text{A}$			1	V
Base to emitter saturation voltage	$V_{BE(sat)}$	$I_C = 5\text{A}, I_B = 1\text{A}$			1.5	V
Transition frequency	$f_T$	$V_{CE} = 10\text{V}, I_C = 0.5\text{A}, f = 10\text{MHz}$		25		MHz
Turn-on time	$t_{on}$	$I_C = 5\text{A}, I_{B1} = 1\text{A}, I_{B2} = -2\text{A}, V_{CC} = 150\text{V}$			0.7	$\mu\text{s}$
Storage time	$t_{stg}$				2	$\mu\text{s}$
Fall time	$t_f$				0.3	$\mu\text{s}$

[查询"2SC3871"供应商](#)

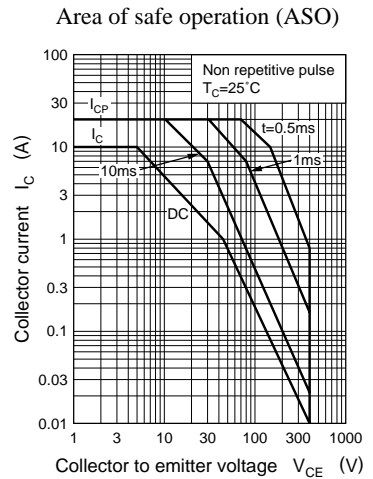
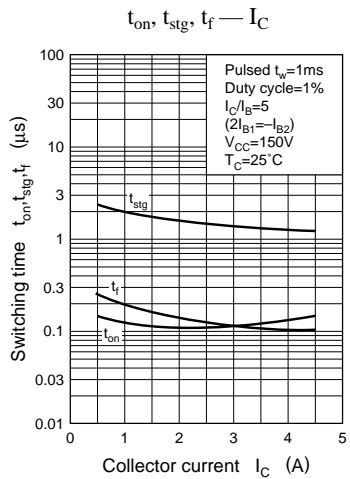
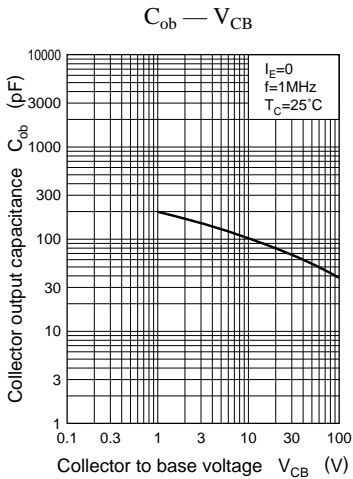
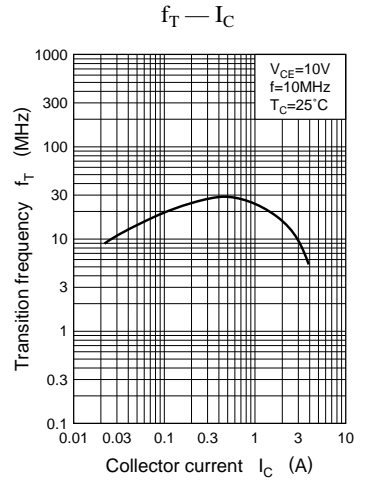
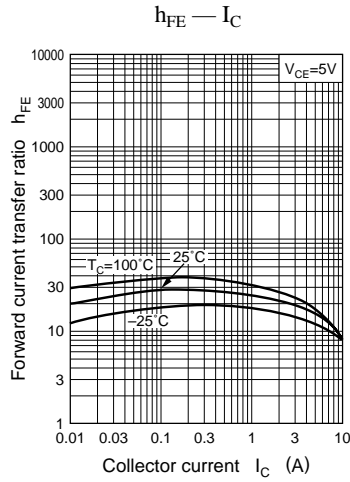
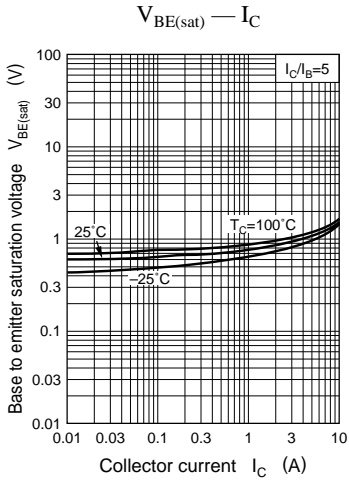
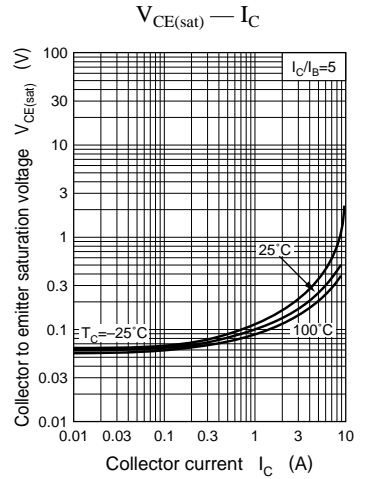
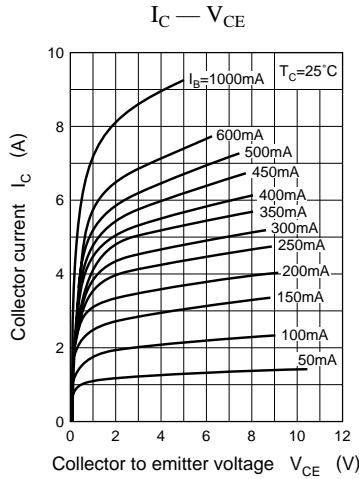
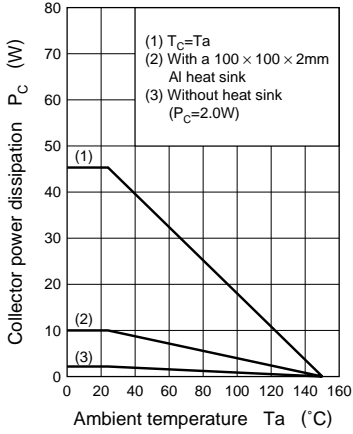

[查询"2SC3871"供应商](#)

Mode of safe operation, reverse bias ASO

Reverse bias ASO measuring circuit

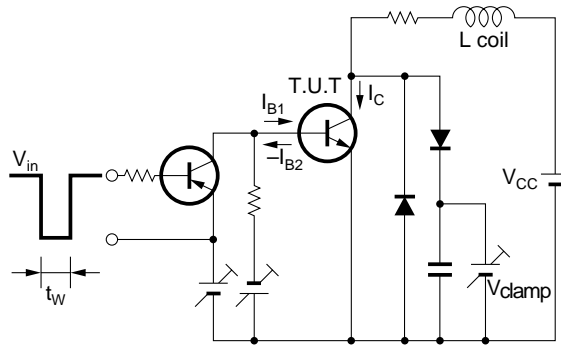
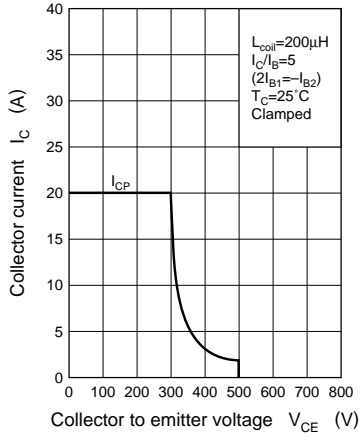

$R_{th(t)} - t$

