

# DTA114EM3T5G Series

Preferred Devices

## Digital Transistors (BRT)

### PNP Silicon Surface Mount Transistors with Monolithic Bias Resistor Network

This new series of digital transistors is designed to replace a single device and its external resistor bias network. The digital transistor contains a single transistor with a monolithic bias network consisting of two resistors; a series base resistor and a base-emitter resistor. The digital transistor eliminates these individual components by integrating them into a single device. The use of a digital transistor can reduce both system cost and board space. The device is housed in the SOT-723 package which is designed for low power surface mount applications.

- Simplifies Circuit Design
- Reduces Board Space
- Reduces Component Count
- The SOT-723 Package can be Soldered using Wave or Reflow.
- Available in 4 mm, 8000 Unit Tape & Reel
- These are Pb-Free Devices

#### MAXIMUM RATINGS ( $T_A = 25^\circ\text{C}$ unless otherwise noted)

Rating	Symbol	Value	Unit
Collector-Base Voltage	$V_{CBO}$	50	Vdc
Collector-Emitter Voltage	$V_{CEO}$	50	Vdc
Collector Current	$I_C$	100	mAdc



ON Semiconductor®

<http://onsemi.com>

## PNP SILICON DIGITAL TRANSISTORS

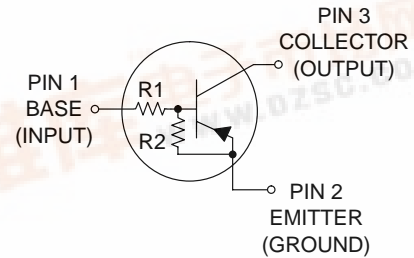

#### MARKING DIAGRAM



xx = Specific Device Code  
(See Marking Table on page 2)  
M = Date Code

#### ORDERING INFORMATION

See detailed ordering and shipping information in the package dimensions section on page 2 of this data sheet.

**Preferred** devices are recommended choices for future use and best overall value.



# DTA114EM3T5G Series

## ORDERING INFORMATION, DEVICE MARKING AND RESISTOR VALUES

Device	Marking	R1 (K)	R2 (K)	Package	Shipping†
DTA114EM3T5G	6A	10	10	SOT-723 (Pb-Free)	8000/Tape & Reel
DTA124EM3T5G*	6B	22	22		
DTA144EM3T5G	6C	47	47		
DTA114YM3T5G	6D	10	47		
DTA114TM3T5G	6E	10	∞		
DTA143TM3T5G*	6F	4.7	∞		
DTA123EM3T5G*	6H	2.2	2.2		
DTA143EM3T5G*	6J	4.7	4.7		
DTA143ZM3T5G*	6K	4.7	47		
DTA124XM3T5G	6L	22	47		
DTA123JM3T5G*	6M	2.2	47		
DTA115EM3T5G	6N	100	100		
DTA144WM3T5G*	6P	47	22		

\*Available upon request

†For information on tape and reel specifications, including part orientation and tape sizes, please refer to our Tape and Reel Packaging Specification Brochure, BRD8011/D.

## THERMAL CHARACTERISTICS

Characteristic	Symbol	Max	Unit
Total Device Dissipation, FR-4 Board (Note 1.) @ $T_A = 25^\circ\text{C}$ Derate above $25^\circ\text{C}$	$P_D$	260 2.0	mW mW/ $^\circ\text{C}$
Thermal Resistance, Junction to Ambient (Note 1.)	$R_{\theta JA}$	480	$^\circ\text{C/W}$
Total Device Dissipation, FR-4 Board (Note 2.) @ $T_A = 25^\circ\text{C}$ Derate above $25^\circ\text{C}$	$P_D$	600 4.8	mW mW/ $^\circ\text{C}$
Thermal Resistance, Junction to Ambient (Note 2.)	$R_{\theta JA}$	205	$^\circ\text{C/W}$
Junction and Storage Temperature Range	$T_J, T_{stg}$	-55 to +150	$^\circ\text{C}$

1. FR-4 @ Minimum Pad
2. FR-4 @  $1.0 \times 1.0$  Inch Pad

# DTA114EM3T5G Series

## ELECTRICAL CHARACTERISTICS (T<sub>A</sub> = 25°C unless otherwise noted)

Characteristic	Symbol	Min	Typ	Max	Unit
<b>OFF CHARACTERISTICS</b>					
Collector–Base Cutoff Current (V <sub>CB</sub> = 50 V, I <sub>E</sub> = 0)	I <sub>CBO</sub>	–	–	100	nAdc
Collector–Emitter Cutoff Current (V <sub>CE</sub> = 50 V, I <sub>B</sub> = 0)	I <sub>CEO</sub>	–	–	500	nAdc
Emitter–Base Cutoff Current (V <sub>EB</sub> = 6.0 V, I <sub>C</sub> = 0)	I <sub>EBO</sub>	–	–	0.5	mAdc
	DTA114EM3T5G	–	–	0.2	
	DTA124EM3T5G	–	–	0.1	
	DTA144EM3T5G	–	–	0.2	
	DTA114YM3T5G	–	–	0.9	
	DTA114TM3T5G	–	–	1.9	
	DTA143TM3T5G	–	–	2.3	
	DTA123EM3T5G	–	–	1.5	
	DTA143EM3T5G	–	–	0.18	
	DTA143ZM3T5G	–	–	0.13	
	DTA124XM3T5G	–	–	0.2	
	DTA123JM3T5G	–	–	0.05	
	DTA115EM3T5G	–	–	0.13	
	DTA144WM3T5G	–	–		
Collector–Base Breakdown Voltage (I <sub>C</sub> = 10 μA, I <sub>E</sub> = 0)	V <sub>(BR)CBO</sub>	50	–	–	Vdc
Collector–Emitter Breakdown Voltage (Note 3.) (I <sub>C</sub> = 2.0 mA, I <sub>B</sub> = 0)	V <sub>(BR)CEO</sub>	50	–	–	Vdc
<b>ON CHARACTERISTICS (Note 3.)</b>					
DC Current Gain (V <sub>CE</sub> = 10 V, I <sub>C</sub> = 5.0 mA)	h <sub>FE</sub>	35	60	–	
	DTA114EM3T5G	60	100	–	
	DTA124EM3T5G	80	140	–	
	DTA144EM3T5G	80	140	–	
	DTA114YM3T5G	160	250	–	
	DTA114TM3T5G	160	250	–	
	DTA143TM3T5G	8.0	15	–	
	DTA123EM3T5G	15	27	–	
	DTA143EM3T5G	80	140	–	
	DTA143ZM3T5G	80	130	–	
	DTA124XM3T5G	80	140	–	
	DTA123JM3T5G	80	150	–	
	DTA115EM3T5G	80	140	–	
	DTA144WM3T5G	80	140	–	
Collector–Emitter Saturation Voltage (I <sub>C</sub> = 10 mA, I <sub>E</sub> = 0.3 mA) (I <sub>C</sub> = 10 mA, I <sub>B</sub> = 5 mA) DTA123EM3T5G (I <sub>C</sub> = 10 mA, I <sub>B</sub> = 1 mA) DTA114TM3T5G/DTA143TM3T5G/ DTA143ZM3T5G/DTA124XM3T5G/DTA143EM3T5G	V <sub>CE(sat)</sub>	–	–	0.25	Vdc
Output Voltage (on) (V <sub>CC</sub> = 5.0 V, V <sub>B</sub> = 2.5 V, R <sub>L</sub> = 1.0 kΩ)	V <sub>OL</sub>	–	–	0.2	Vdc
	DTA114EM3T5G	–	–	0.2	
	DTA124EM3T5G	–	–	0.2	
	DTA114YM3T5G	–	–	0.2	
	DTA114TM3T5G	–	–	0.2	
	DTA143TM3T5G	–	–	0.2	
	DTA123EM3T5G	–	–	0.2	
	DTA143EM3T5G	–	–	0.2	
	DTA143ZM3T5G	–	–	0.2	
	DTA124XM3T5G	–	–	0.2	
	DTA123JM3T5G	–	–	0.2	
(V <sub>CC</sub> = 5.0 V, V <sub>B</sub> = 3.5 V, R <sub>L</sub> = 1.0 kΩ)	DTA144EM3T5G	–	–	0.2	
(V <sub>CC</sub> = 5.0 V, V <sub>B</sub> = 5.5 V, R <sub>L</sub> = 1.0 kΩ)	DTA115EM3T5G	–	–	0.2	
(V <sub>CC</sub> = 5.0 V, V <sub>B</sub> = 4.0 V, R <sub>L</sub> = 1.0 kΩ)	DTA144WM3T5G	–	–	0.2	
Output Voltage (off) (V <sub>CC</sub> = 5.0 V, V <sub>B</sub> = 0.5 V, R <sub>L</sub> = 1.0 kΩ) (V <sub>CC</sub> = 5.0 V, V <sub>B</sub> = 0.25 V, R <sub>L</sub> = 1.0 kΩ)	V <sub>OH</sub>	4.9	–	–	Vdc
	DTA114TM3T5G				
	DTA143TM3T5G				
	DTA123EM3T5G				
	DTA143EM3T5G				

3. Pulse Test: Pulse Width < 300 μs, Duty Cycle < 2.0%

# DTA114EM3T5G Series

查询DTA114EM3T5G 响应器

(T<sub>A</sub> = 25°C unless otherwise noted) (Continued)

Characteristic	Symbol	Min	Typ	Max	Unit	
Input Resistor	DTA114EM3T5G	R1	7.0	10	13	kΩ
	DTA124EM3T5G		15.4	22	28.6	
	DTA144EM3T5G		32.9	47	61.1	
	DTA114YM3T5G		7.0	10	13	
	DTA114TM3T5G		7.0	10	13	
	DTA143TM3T5G		3.3	4.7	6.1	
	DTA123EM3T5G		1.5	2.2	2.9	
	DTA143EM3T5G		3.3	4.7	6.1	
	DTA143ZM3T5G		3.3	4.7	6.1	
	DTA124XM3T5G		15.4	22	28.6	
	DTA123JM3T5G		1.54	2.2	2.86	
	DTA115EM3T5G		70	100	130	
	DTA144WM3T5G		32.9	47	61.1	
Resistor Ratio /	DTA114EM3T5G/DTA124EM3T5G/DTA144EM3T5G  DTA115EM3T5G DTA114YM3T5G DTA114TM3T5G/DTA143TM3T5G DTA123EM3T5G/DTA143EM3T5G DTA143ZM3T5G DTA124XM3T5G DTA123JM3T5G DTA144WM3T5G	R <sub>1</sub> /R <sub>2</sub>	0.8 0.17 – 0.8 0.055 0.38 0.038 1.7	1.0 0.21 – 1.0 0.1 0.47 0.047 2.1	1.2 0.25 – 1.2 0.185 0.56 0.056 2.6	

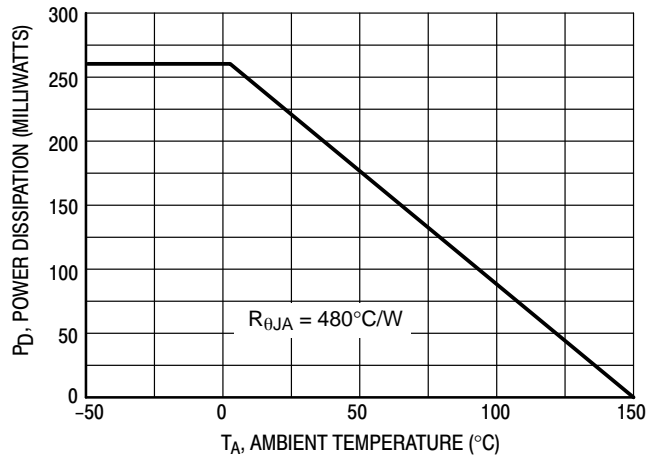

**Figure 1. Derating Curve**

# DTA114EM3T5G Series

## TYPICAL ELECTRICAL CHARACTERISTICS – DTA114EM3T5G

查询"DTA144EM3T5G"供应商

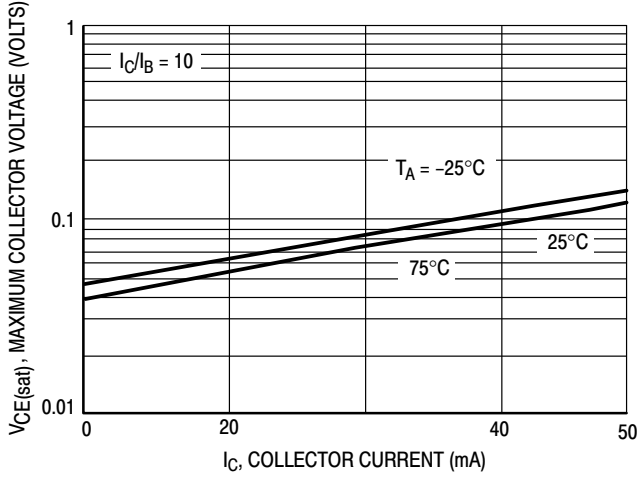

Figure 2.  $V_{CE(sat)}$  versus  $I_C$

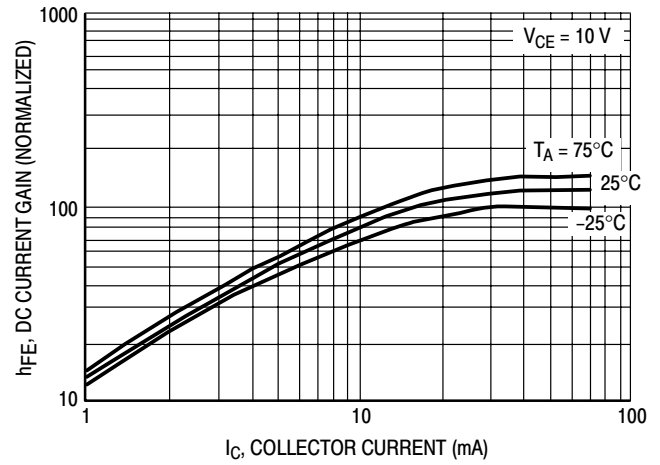

Figure 3. DC Current Gain

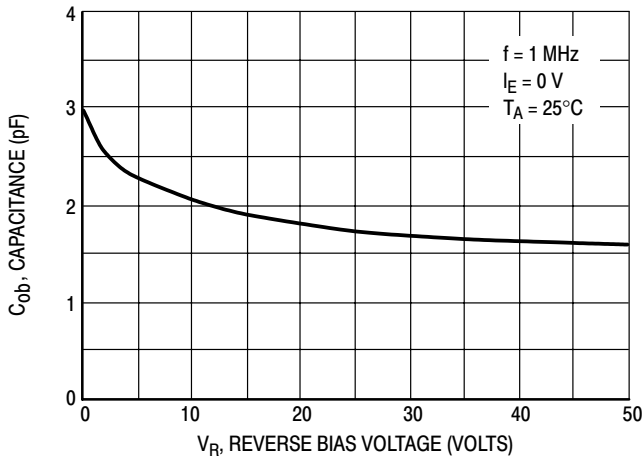

Figure 4. Output Capacitance

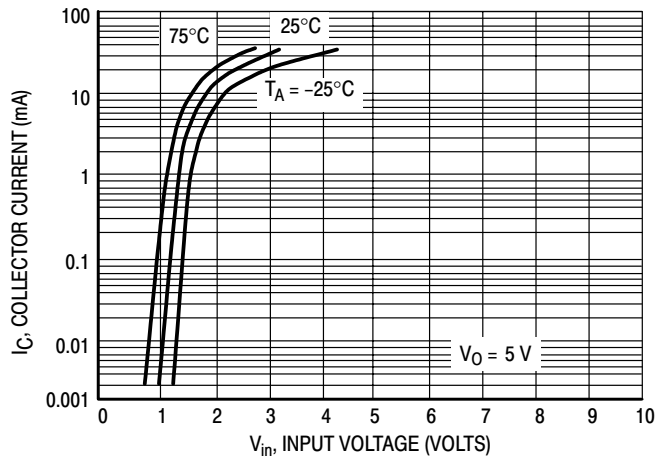

Figure 5. Output Current versus Input Voltage

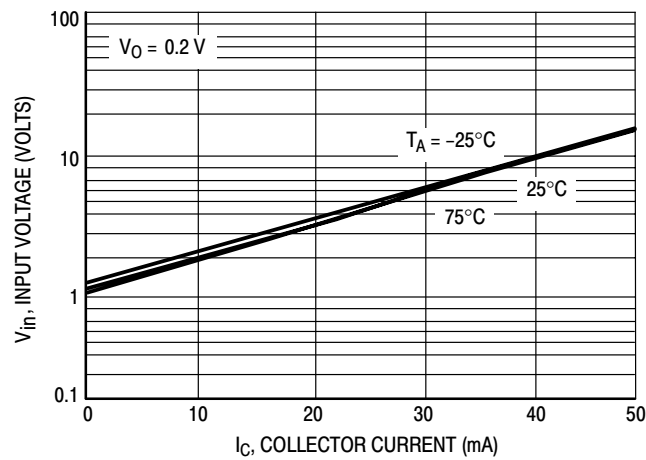

Figure 6. Input Voltage versus Output Current

# DTA114EM3T5G Series

## TYPICAL ELECTRICAL CHARACTERISTICS – DTA124EM3T5G

查询"DTA144EM3T5G"供应商

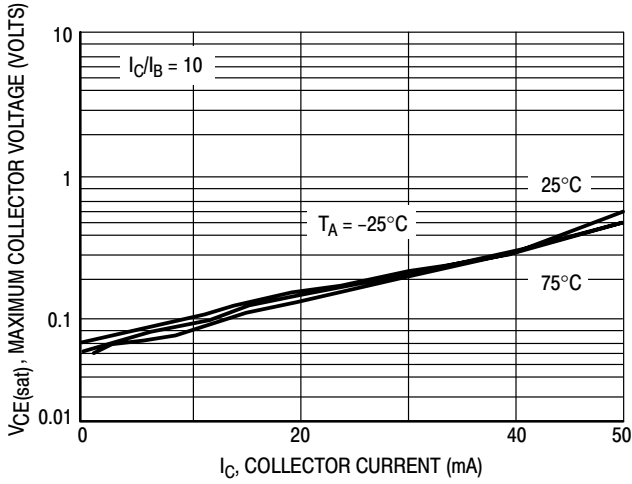

Figure 7.  $V_{CE(sat)}$  versus  $I_C$

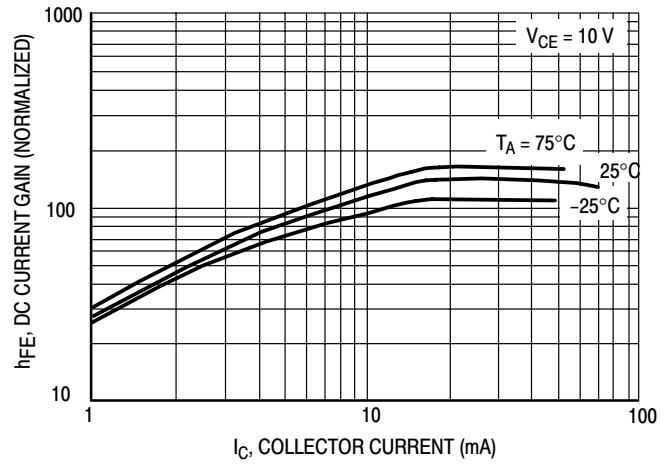

Figure 8. DC Current Gain

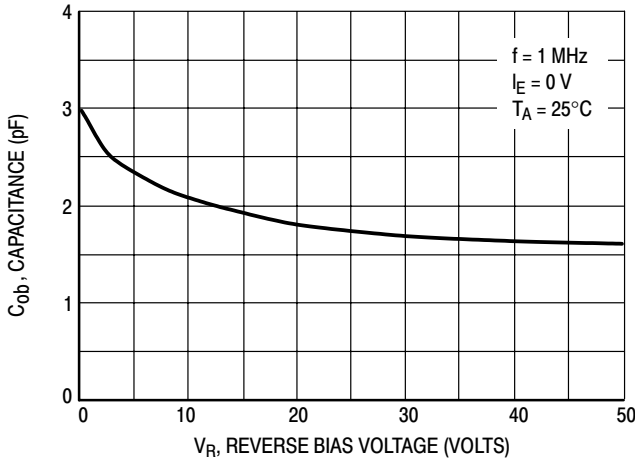

Figure 9. Output Capacitance

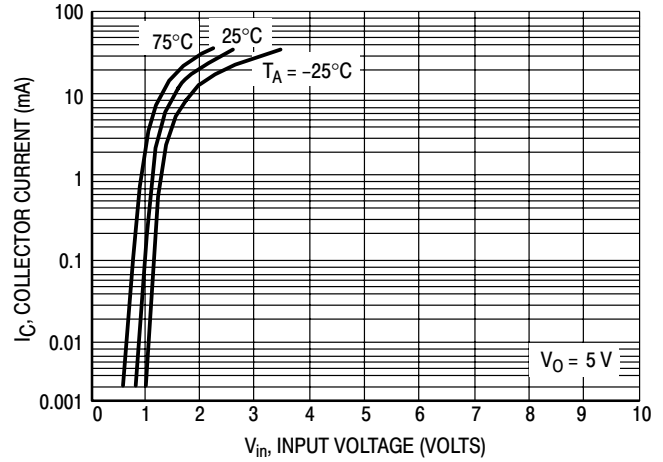

Figure 10. Output Current versus Input Voltage

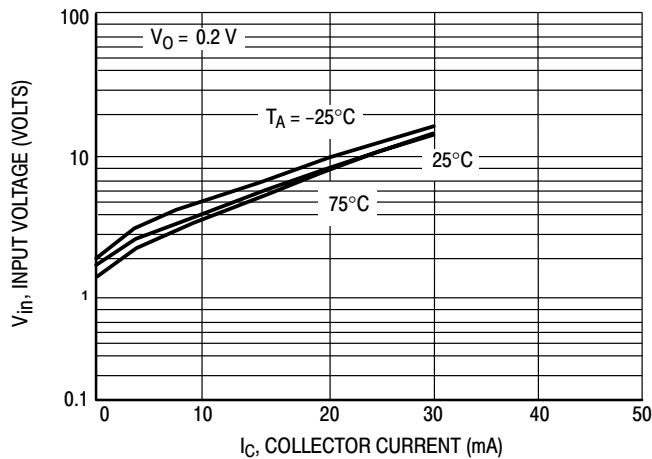

Figure 11. Input Voltage versus Output Current

# DTA114EM3T5G Series

## TYPICAL ELECTRICAL CHARACTERISTICS – DTA144EM3T5G

[查询"DTA144EM3T5G"供应商](#)

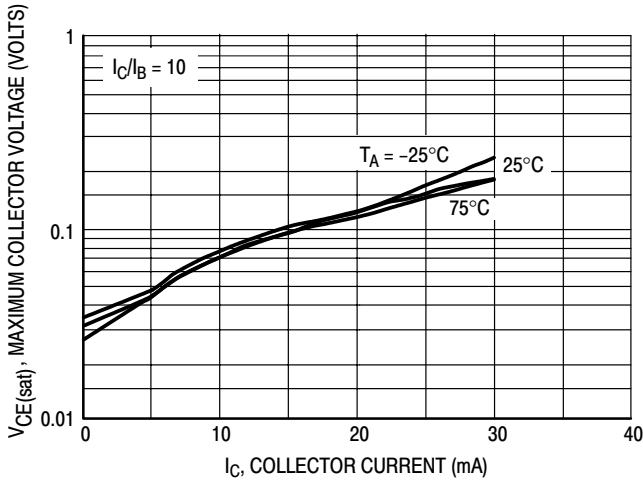

Figure 12.  $V_{CE(sat)}$  versus  $I_C$

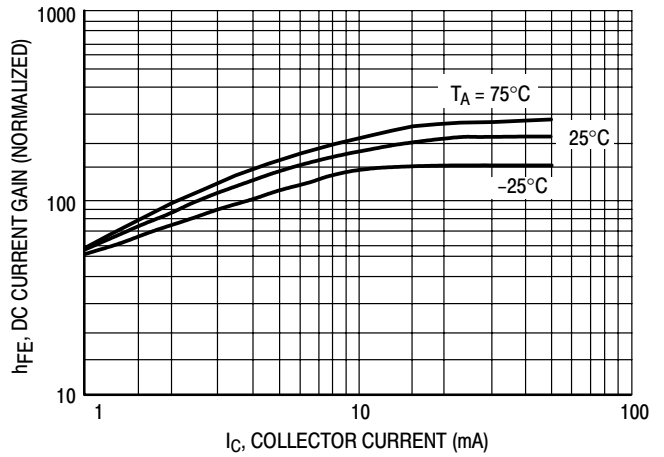

Figure 13. DC Current Gain

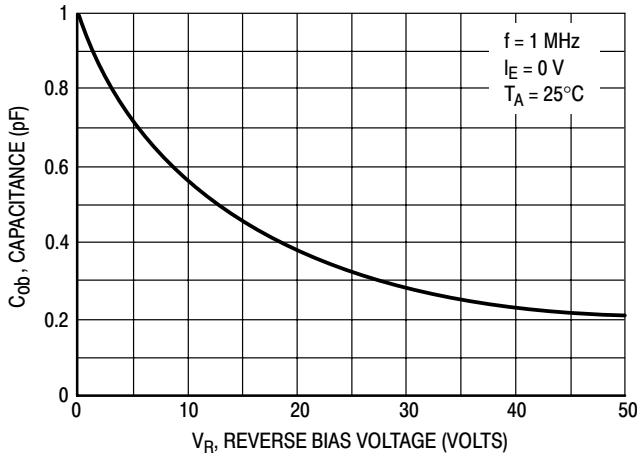

Figure 14. Output Capacitance

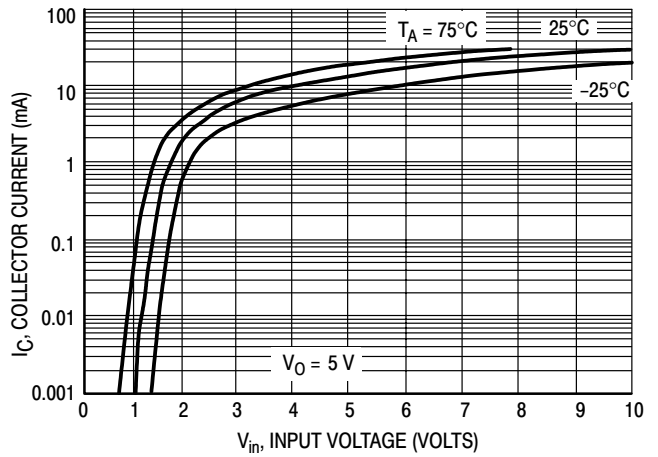

Figure 15. Output Current versus Input Voltage

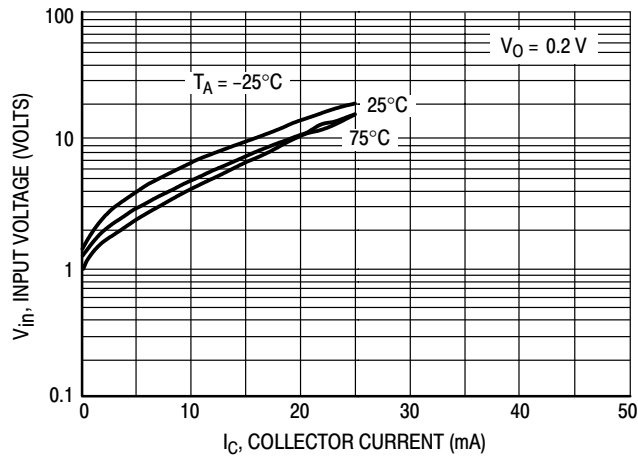

Figure 16. Input Voltage versus Output Current

# DTA114EM3T5G Series

## TYPICAL ELECTRICAL CHARACTERISTICS – DTA114YM3T5G

查询"DTA144EM3T5G"供应商

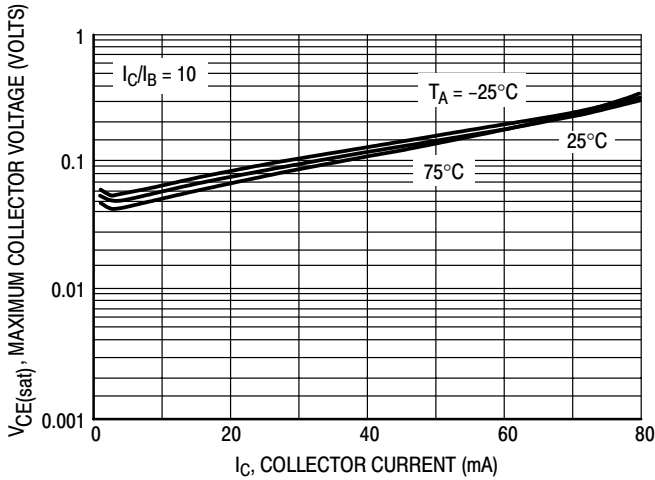

Figure 17.  $V_{CE(sat)}$  versus  $I_C$

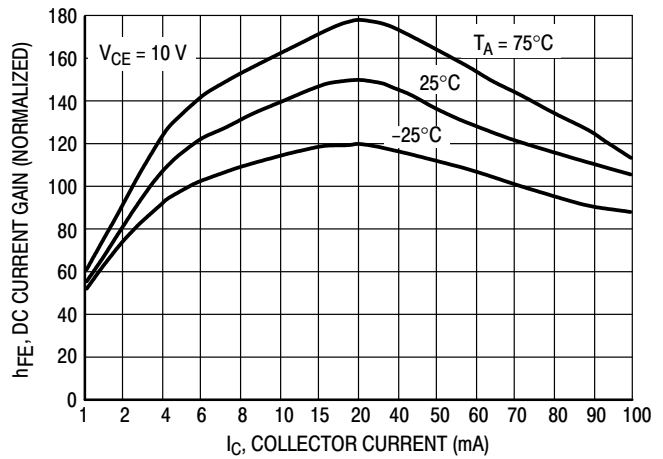

Figure 18. DC Current Gain

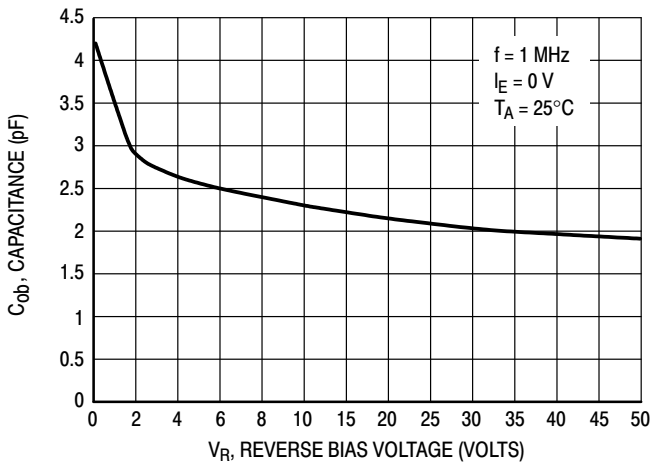

Figure 19. Output Capacitance

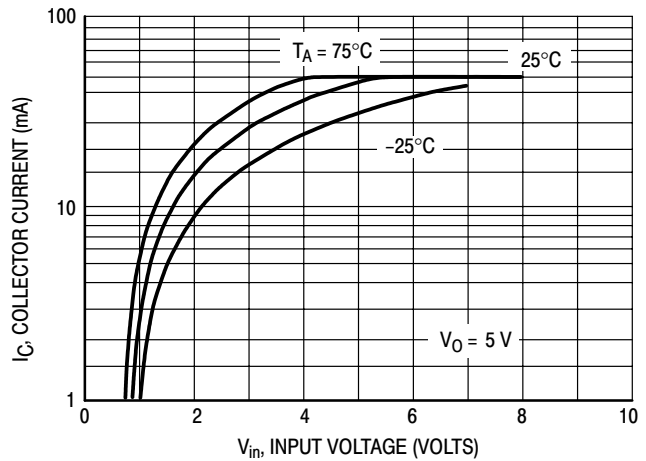

Figure 20. Output Current versus Input Voltage

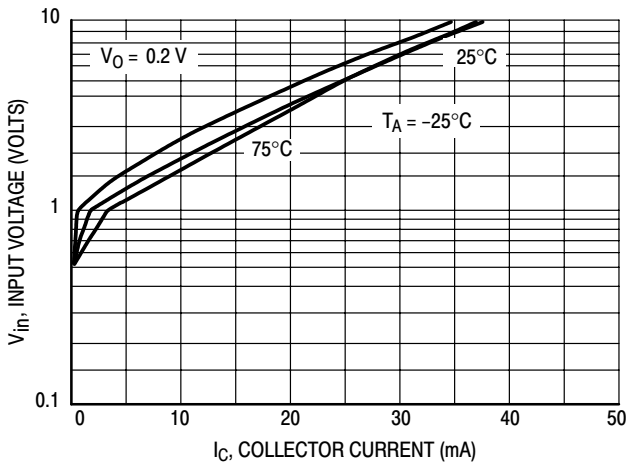

Figure 21. Input Voltage versus Output Current

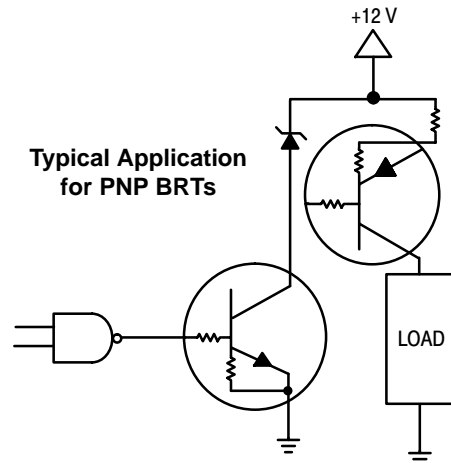

Figure 22. Inexpensive, Unregulated Current Source



# DTA114EM3T5G Series

## TYPICAL ELECTRICAL CHARACTERISTICS — DTA115EM3T5G

[查询"DTA144EM3T5G"供应商](#)

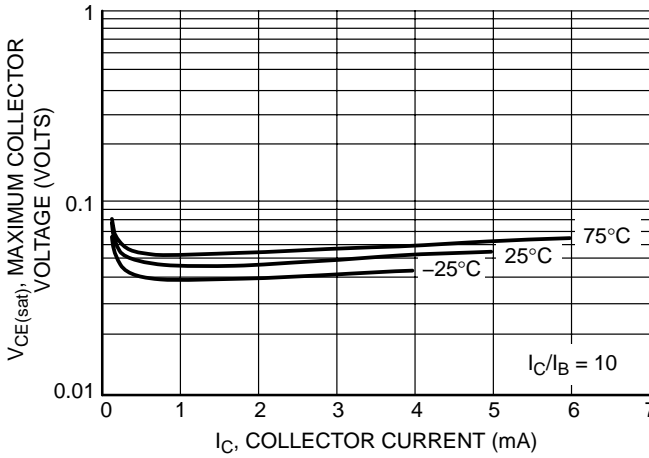

**Figure 23. Maximum Collector Voltage versus Collector Current**

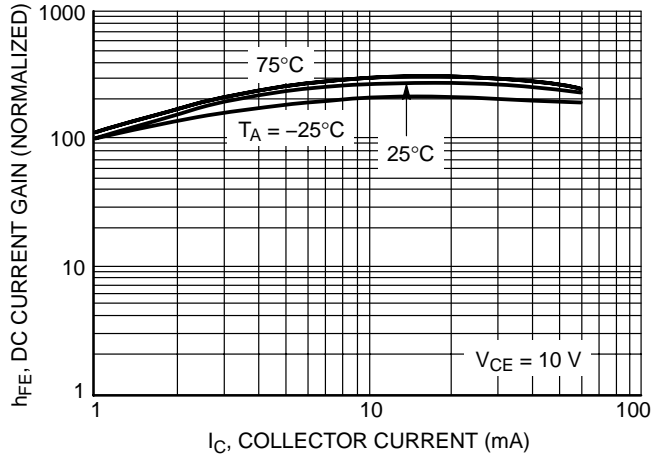

**Figure 24. DC Current Gain**

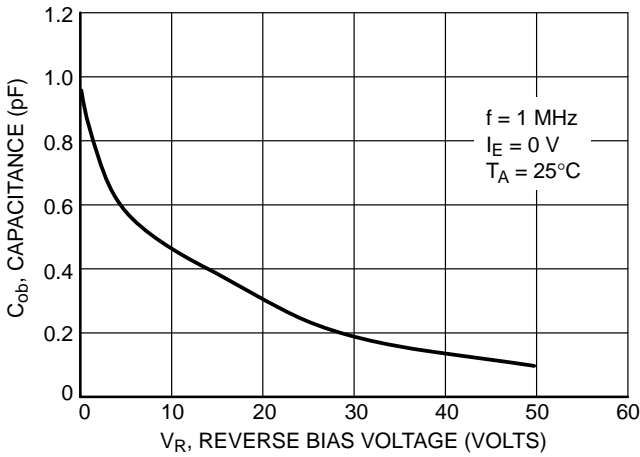

**Figure 25. Output Capacitance**

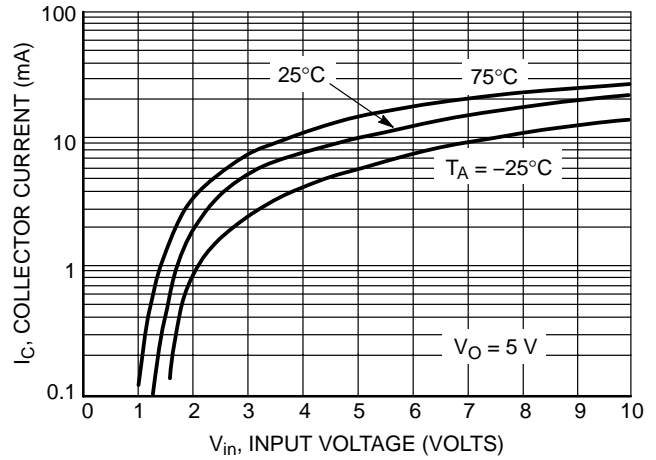

**Figure 26. Output Current versus Input Voltage**

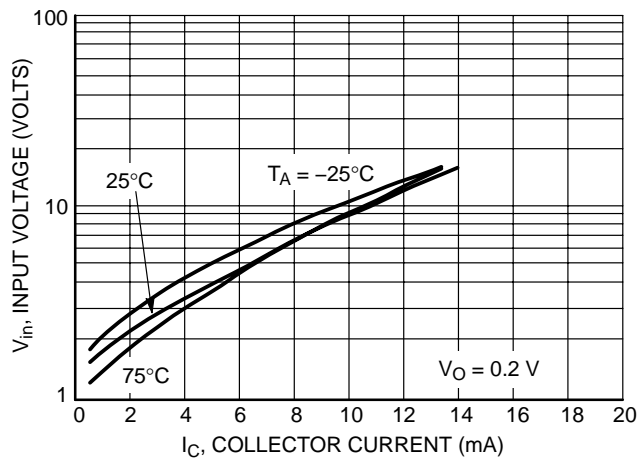
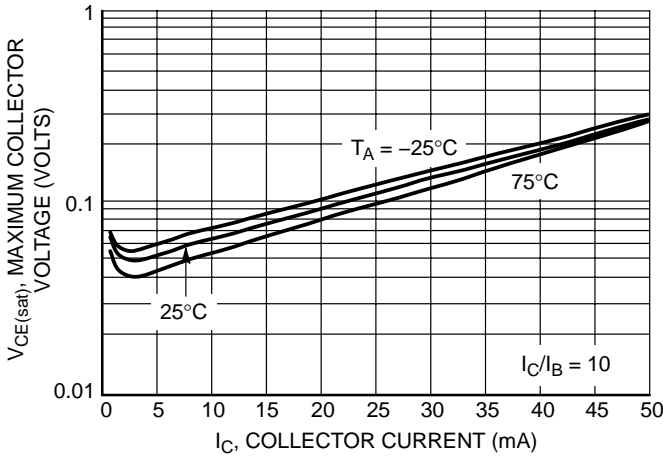

**Figure 27. Input Voltage versus Output Current**

# DTA114EM3T5G Series

## TYPICAL ELECTRICAL CHARACTERISTICS — DTA144WM3T5G

[查询"DTA144EM3T5G" 供应商](#)



**Figure 28. Maximum Collector Voltage versus Collector Current**

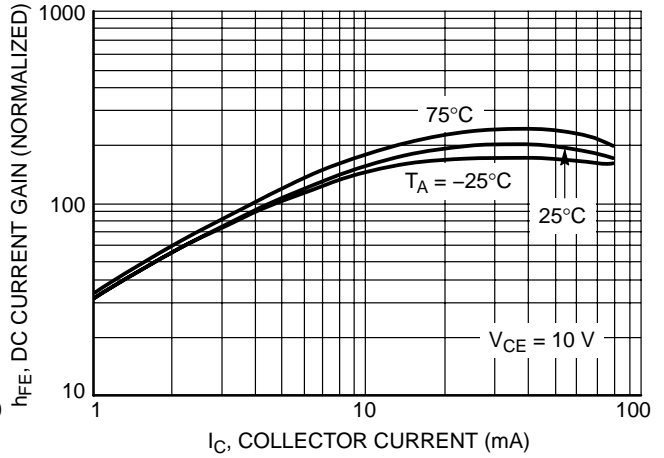

**Figure 29. DC Current Gain**

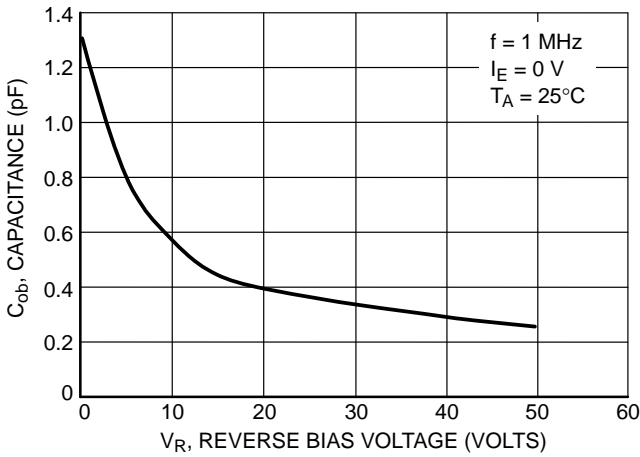

**Figure 30. Output Capacitance**

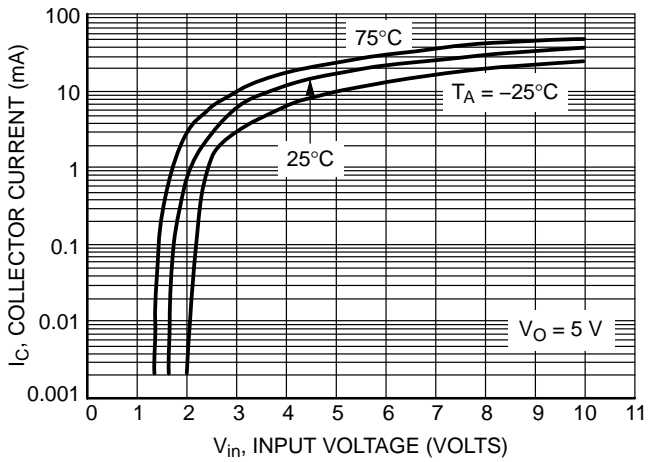

**Figure 31. Output Current versus Input Voltage**

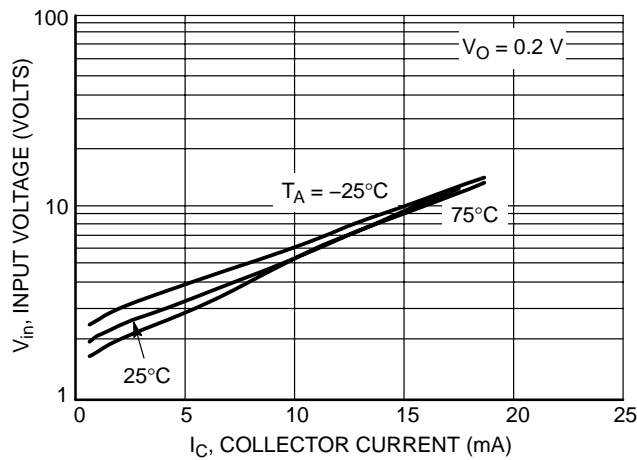

**Figure 32. Input Voltage versus Output Current**

# DTA114EM3T5G Series

[查询"DTA144EM3T5G"供应商](#)

## PACKAGE DIMENSIONS

**SOT-723**  
CASE 631AA-01  
ISSUE A

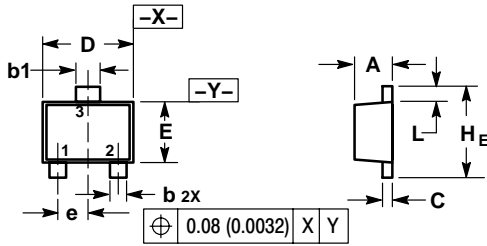

**NOTES:**

1. DIMENSIONING AND TOLERANCING PER ANSI Y14.5M, 1982.
2. CONTROLLING DIMENSION: MILLIMETERS.
3. MAXIMUM LEAD THICKNESS INCLUDES LEAD FINISH. MINIMUM LEAD THICKNESS IS THE MINIMUM THICKNESS OF BASE MATERIAL.
4. DIMENSIONS D AND E DO NOT INCLUDE MOLD FLASH, PROTRUSIONS OR GATE BURRS.

DIM	MILLIMETERS			INCHES		
	MIN	NOM	MAX	MIN	NOM	MAX
A	0.45	0.50	0.55	0.018	0.020	0.022
b	0.15	0.20	0.27	0.0059	0.0079	0.0106
b1	0.25	0.3	0.35	0.010	0.012	0.014
C	0.07	0.12	0.17	0.0028	0.0047	0.0067
D	1.15	1.20	1.25	0.045	0.047	0.049
E	0.75	0.80	0.85	0.03	0.032	0.034
e	0.40 BSC			0.016 BSC		
HE	1.15	1.20	1.25	0.045	0.047	0.049
L	0.15	0.20	0.25	0.0059	0.0079	0.0098

STYLE 1:  
PIN 1. BASE  
2. EMITTER  
3. COLLECTOR

### SOLDERING FOOTPRINT\*

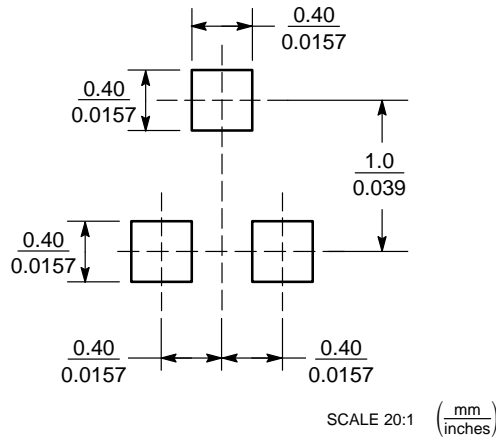

### SOT-723

\*For additional information on our Pb-Free strategy and soldering details, please download the ON Semiconductor Soldering and Mounting Techniques Reference Manual, SOLDERRM/D.

# DTA114EM3T5G Series

[查询"DTA144EM3T5G"供应商](#)

**ON Semiconductor** and  are registered trademarks of Semiconductor Components Industries, LLC (SCILLC). SCILLC reserves the right to make changes without further notice to any products herein. SCILLC makes no warranty, representation or guarantee regarding the suitability of its products for any particular purpose, nor does SCILLC assume any liability arising out of the application or use of any product or circuit, and specifically disclaims any and all liability, including without limitation special, consequential or incidental damages. "Typical" parameters which may be provided in SCILLC data sheets and/or specifications can and do vary in different applications and actual performance may vary over time. All operating parameters, including "Typicals" must be validated for each customer application by customer's technical experts. SCILLC does not convey any license under its patent rights nor the rights of others. SCILLC products are not designed, intended, or authorized for use as components in systems intended for surgical implant into the body, or other applications intended to support or sustain life, or for any other application in which the failure of the SCILLC product could create a situation where personal injury or death may occur. Should Buyer purchase or use SCILLC products for any such unintended or unauthorized application, Buyer shall indemnify and hold SCILLC and its officers, employees, subsidiaries, affiliates, and distributors harmless against all claims, costs, damages, and expenses, and reasonable attorney fees arising out of, directly or indirectly, any claim of personal injury or death associated with such unintended or unauthorized use, even if such claim alleges that SCILLC was negligent regarding the design or manufacture of the part. SCILLC is an Equal Opportunity/Affirmative Action Employer. This literature is subject to all applicable copyright laws and is not for resale in any manner.

## PUBLICATION ORDERING INFORMATION

### LITERATURE FULFILLMENT:

Literature Distribution Center for ON Semiconductor  
P.O. Box 5163, Denver, Colorado 80217 USA

**Phone:** 303-675-2175 or 800-344-3860 Toll Free USA/Canada

**Fax:** 303-675-2176 or 800-344-3867 Toll Free USA/Canada

**Email:** [orderlit@onsemi.com](mailto:orderlit@onsemi.com)

**N. American Technical Support:** 800-282-9855 Toll Free  
USA/Canada

**Japan:** ON Semiconductor, Japan Customer Focus Center  
2-9-1 Kamimeguro, Meguro-ku, Tokyo, Japan 153-0051  
**Phone:** 81-3-5773-3850

**ON Semiconductor Website:** <http://onsemi.com>

**Order Literature:** <http://www.onsemi.com/litorder>

For additional information, please contact your  
local Sales Representative.

**DTA114EM3/D**