

MVL-324GD  
 MVL-324YD  
 MVL-324HRD  
 MVL-324DRD  
 MVL-324URD

04/30/2002

## Description

The MVL-324xxD series package are T-1( $\phi 3\text{mm}$ ) standard double flange water clear plastic lens package. The Hi-EFF red (HR) and yellow LED chips are made with Gallium Arsenide Phosphide on Gallium Phosphide diode. The green LED chip is made with Gallium Phosphide on Gallium Phosphide diode. The red (DR) chip is made with Aluminum Gallium Arsenide on Gallium Arsenide diode. The red (UR) chip is made with Aluminum Gallium Arsenide on Aluminum Gallium Arsenide diode.

## Applications

- Popular T-1 ( $\phi 3\text{mm}$ ) diameter package
- Selected minimum intensities
- General purpose leads
- Reliable and rugged

## Absolute Maximum Ratings

Parameter	Symbol	Maximum Rating				Unit
		GREEN	YELLOW	HR	DR/UR	
Power Dissipation	Pad	100	60	100	100	mW
Peak Forward Current (1/10 Duty Cycle 0.1ms pulse width)	I <sub>pf</sub>	120	80	120	120	A
Continuous Forward Current	I <sub>af</sub>	30	20	30	40	mA/°C
Derating Linear From 25°C		0.4	0.25	0.4	0.5	mA
Reverse Voltage	V <sub>R</sub>	5	5	5	5	V
Operating Temperature Range	T <sub>opr</sub>	-55°C to + 100°C				
Storage Temperature Range	T <sub>stg</sub>	-55°C to + 100°C				
Lead Soldering Temperature (1.6mm from body) for 3 seconds at 260°C						

## Package Dimensions

Unit: mm ( inches )

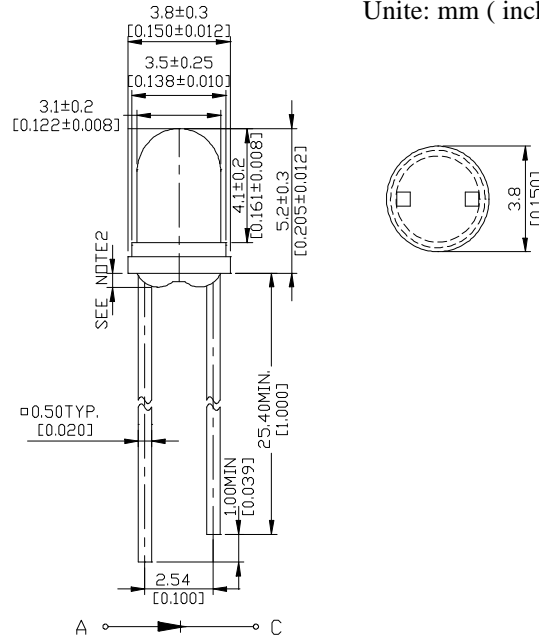

NOTES :

1. Tolerance is  $\pm 0.25$  mm (.010") unless otherwise noted.
2. Protruded resin under flange is 1.5 mm (.059") max.
3. Lead spacing is measured where the leads emerge from the package.

## Optical -Electrical Characteristics

### Part No. : MVL-324GD

@T<sub>A</sub>=25°C

Parameter	Test Conditions	Symbol	Min .	Typ .	Max .	Unit .
Luminous Intensity	I <sub>F</sub> =10mA	I <sub>V</sub>	14.0	45	-	mcd
Forward Voltage	I <sub>F</sub> =20mA	V <sub>F</sub>	-	2.1	2.8	V
Reverse Current	V <sub>R</sub> =5V	I <sub>R</sub>	-	-	100	μA
Wavelength	I <sub>F</sub> =20mA	λ <sub>p</sub>	-	565	-	nm
Spectral Line Half Width	I <sub>F</sub> =20mA	Δλ	-	30	-	nm
Viewing Angle	I <sub>F</sub> =20mA	2θ <sub>1/2</sub>	-	45	-	deg

### Part No. : MVL-324YD

@T<sub>A</sub>=25°C

Parameter	Test Conditions	Symbol	Min .	Typ .	Max .	Unit .
Luminous Intensity	I <sub>F</sub> =10mA	I <sub>V</sub>	8.0	30	-	mcd
Forward Voltage	I <sub>F</sub> =20mA	V <sub>F</sub>	-	2.1	2.8	V
Reverse Current	V <sub>R</sub> =5V	I <sub>R</sub>	-	-	100	μA
Wavelength	I <sub>F</sub> =20mA	λ <sub>p</sub>	-	585	-	nm
Spectral Line Half Width	I <sub>F</sub> =20mA	Δλ	-	35	-	nm
Viewing Angle	I <sub>F</sub> =20mA	2θ <sub>1/2</sub>	-	45	-	deg

### Part No. : MVL-324HRD

@T<sub>A</sub>=25°C

Parameter	Test Conditions	Symbol	Min .	Typ .	Max .	Unit .
Luminous Intensity	I <sub>F</sub> =10mA	I <sub>V</sub>	12.0	40	-	mcd
Forward Voltage	I <sub>F</sub> =20mA	V <sub>F</sub>	-	2.0	2.8	V
Reverse Current	V <sub>R</sub> =5V	I <sub>R</sub>	-	-	100	μA
Wavelength	I <sub>F</sub> =20mA	λ <sub>p</sub>	-	640	-	nm
Spectral Line Half Width	I <sub>F</sub> =20mA	Δλ	-	40	-	nm
Viewing Angle	I <sub>F</sub> =20mA	2θ <sub>1/2</sub>	-	45	-	deg

### Part No. : MVL-324DRD

@T<sub>A</sub>=25°C

Parameter	Test Conditions	Symbol	Min .	Typ .	Max .	Unit .
Luminous Intensity	I <sub>F</sub> =20mA	I <sub>V</sub>	50	200	-	mcd
Forward Voltage	I <sub>F</sub> =20mA	V <sub>F</sub>	-	1.8	2.4	V
Reverse Current	V <sub>R</sub> =5V	I <sub>R</sub>	-	-	100	μA
Wavelength	I <sub>F</sub> =20mA	λ <sub>p</sub>	-	660	-	nm
Spectral Line Half Width	I <sub>F</sub> =20mA	Δλ	-	20	-	nm
Viewing Angle	I <sub>F</sub> =20mA	2θ <sub>1/2</sub>	-	45	-	deg

### Part No. : MVL-324URD

@T<sub>A</sub>=25°C

Parameter	Test Conditions	Symbol	Min .	Typ .	Max .	Unit .
Luminous Intensity	I <sub>F</sub> =20mA	I <sub>V</sub>	100	400	-	mcd
Forward Voltage	I <sub>F</sub> =20mA	V <sub>F</sub>	-	1.8	2.4	V
Reverse Current	V <sub>R</sub> =5V	I <sub>R</sub>	-	-	100	μA
Wavelength	I <sub>F</sub> =20mA	λ <sub>p</sub>	-	660	-	nm
Spectral Line Half Width	I <sub>F</sub> =20mA	Δλ	-	20	-	nm
Viewing Angle	I <sub>F</sub> =20mA	2θ <sub>1/2</sub>	-	45	-	deg

## Typical Optical-Electrical Characteristic Curves

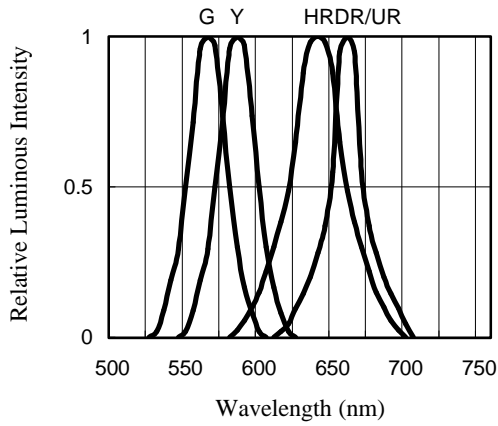

Fig 1. RELATIVE LUMINOUS INTENSITY VS. WAVELENGTH

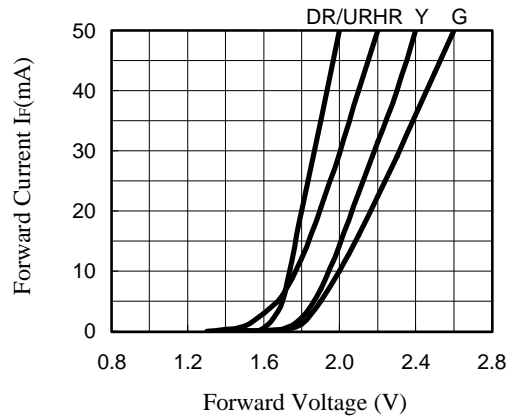

Fig 2. FORWARD CURRENT VS. FORWARD VOLTAGE

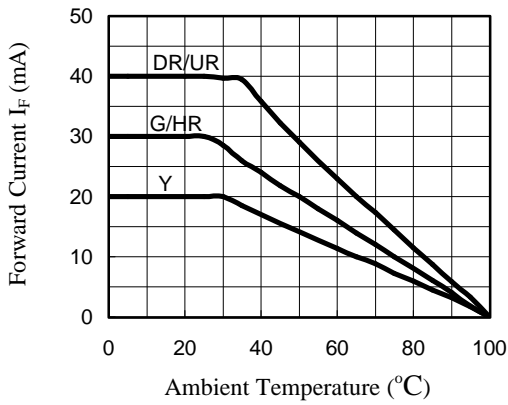

Fig 3. FORWARD CURRENT VS. AMBIENT TEMPERATURE

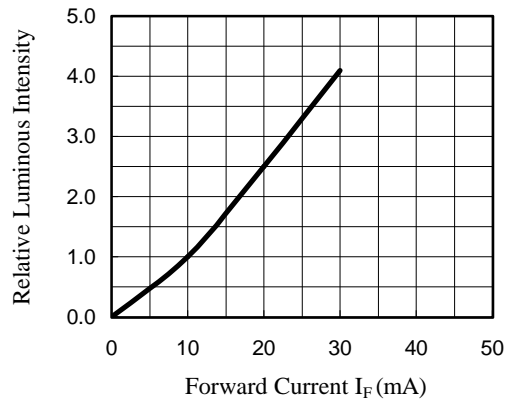

Fig 4. RELATIVE LUMINOUS INTENSITY VS. FORWARD CURRENT

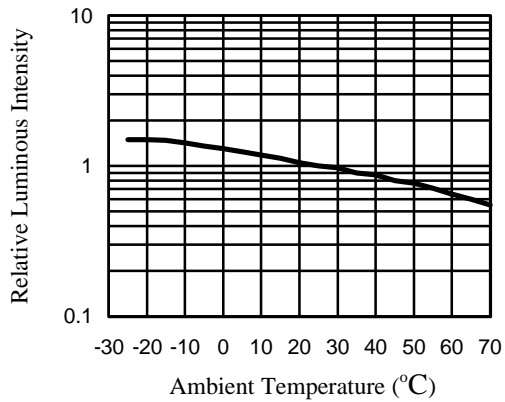

Fig 5. RELATIVE LUMINOUS INTENSITY VS. AMBIENT TEMPERATURE

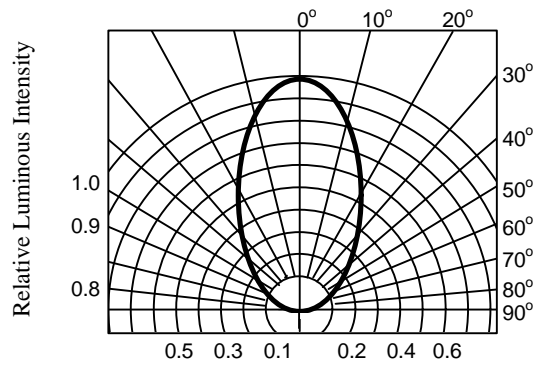

Fig 6. RADIATION DIAGRAM