



MC13077

Advanced PAL/NTSC Encoder

The MC13077 is a high quality RGB/YUV to NTSC/PAL encoder with Composite Video and S-Video outputs. The IC integrates the color difference and luma matrix circuitry, chroma modulators, subcarrier oscillator, and logic circuitry to encode component video into a composite video signal compatible with the NTSC/PAL standards. The IC operates off a standard +5.0 V supply and typically requires less than 75 mA, making it useful in PC environments. The high degree of integration saves board space and cost, as only passive external components are required for operation. The IC is manufactured using Motorola's MOSAIC™ process and is available in a 20 pin DIP or SOIC package.

- Single 5.0 V Supply
- Composite Output
- S-Video Outputs
- PAL/NTSC Switchable
- PAL Squarewave Output
- PAL Sequence Resettable
- Internal/External Burst Flag
- Digitally Determined Modulator Axes
- Subcarrier Reference Drive Selectable

ADVANCED PAL/NTSC ENCODER

SEMICONDUCTOR TECHNICAL DATA

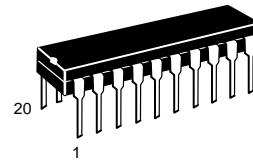

P SUFFIX
PLASTIC PACKAGE
CASE 738

DW SUFFIX
PLASTIC PACKAGE
CASE 751D
(SO-20L)

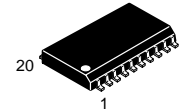

ORDERING INFORMATION

Device	Operating Temperature Range	Package
MC13077DW	T _A = 0° to +70°C	SO-20L
MC13077P		Plastic DIP

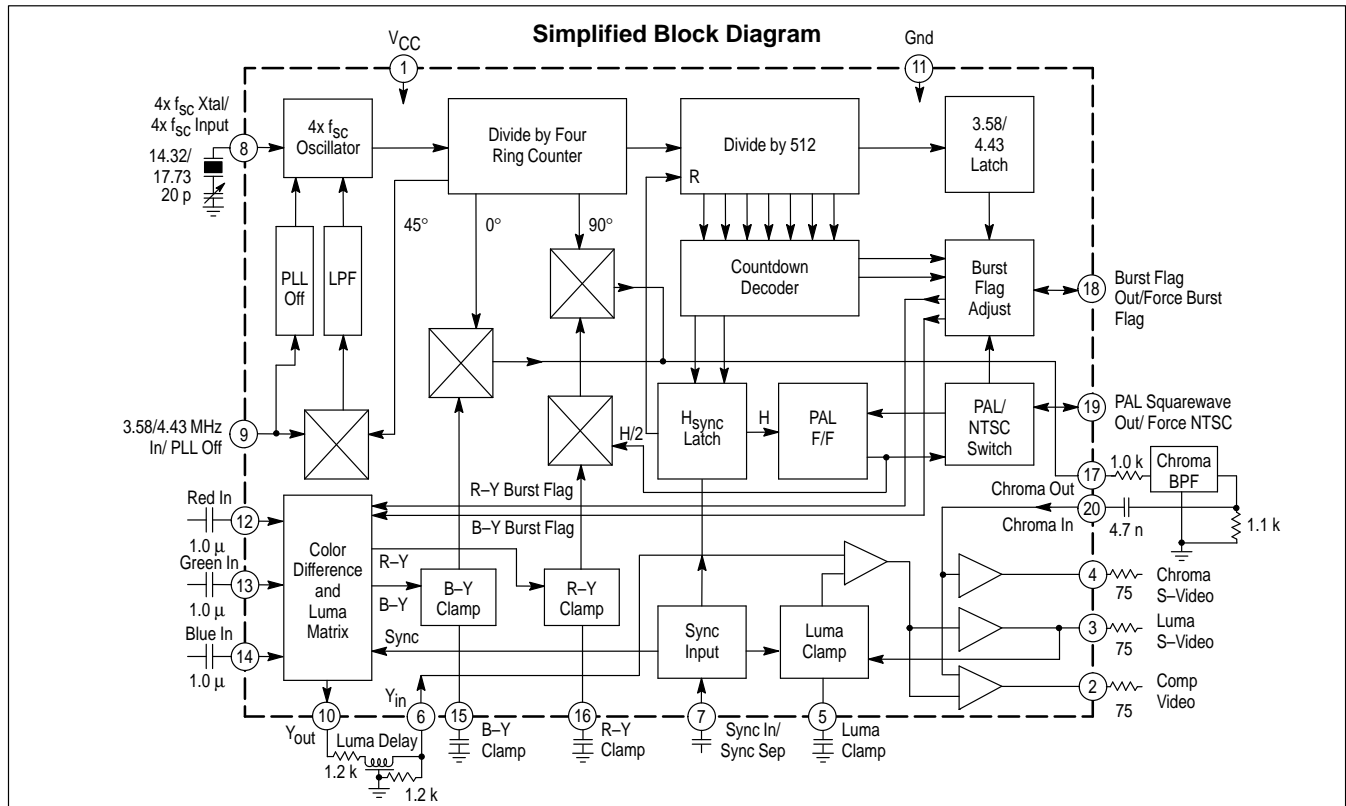

MC13077

MAXIMUM RATINGS

Symbol	Value	Unit	
Supply Voltage	V_{CC}	6.0	V
Storage Temperature	T_{stg}	- 65 to +150	°C
Operating Junction Temperature	T_J	+150	°C
Operating Ambient Temperature	T_A	0 to + 70	°C

RECOMMENDED OPERATING CONDITIONS

Characteristic	Min	Typ	Max	Unit
Supply Voltage	4.5	5.0	5.5	Vdc
Sync Input Threshold Equivalent (See Figure 2) Pulse Width	-	1.4 4.5 – 5.5	-	Vdc μ s
R, G, B Input (Amplitude for 100% Saturated Video)	-	0.7	-	Vpp
R–Y Input Amplitude at Pin 16 (for 100% Saturated Video)	-	490	-	mVpp
B–Y Input Amplitude at Pin 15 (for 100% Saturated Video)	-	350	-	
Y Input Amplitude (without sync) at Pins 12, 13, 14 (for 100% Saturated Video)	-	700	-	
Y Input Amplitude (with sync) at Delay Line	-	1.0	-	Vpp
External 4x Subcarrier Input to Pin 8 (If crystal is not used)	-	300	-	mVpp
External Subcarrier Input to Pin 9 Lock Range (with 4x Subcarrier Crystal specified) at Subcarrier Frequency	-	0.10 to 3.0 \pm 400	-	Vpp Hz
Burst Flag Input Threshold (Pin 18)	-	2.5	-	Vdc
NTSC/PAL Select (Pin 19) PAL Switching Amplitude: High Low NTSC Select Threshold	- - -	4.0 1.1 0.4	- - -	Vdc

ELECTRICAL CHARACTERISTICS ($T_A = 25^\circ\text{C}$, $V_{CC} = 5.0$ Vdc, test circuit of Figure 1.)

Characteristic	Pin	Min	Typ	Max	Unit
Supply Current (150 Ω Load on Output Pins)	1	55	70	85	mA
Color Burst Amplitude		250	300	350	mVpp
Line-to-Line Burst Amplitude Deviation		-	7.0	25	mV
Start after leading edge of Sync: NTSC (3.579 MHz) PAL (4.43 MHz)	2 & 4 (@ 75 Ω load)	-	5.0 to 5.3 5.4 to 5.6	-	μ s
Duration: NTSC (3.579 MHz) PAL (4.43 MHz)		-	9 10	-	Cycles
PAL Burst Phase: Line n Line n+1		125 215	135 225	145 235	Degrees
NTSC Burst Phase		170	180	190	
Subcarrier Leakage in Black White (100% white)	2 & 4 (@ 75 Ω load)	- -	- -	25 65	mV
Composite Video Output (100% saturated output)					
Sync Amplitude		240	281	320	mVpp
Line-to-Line Sync Amplitude Deviation (PAL)		-	7.0	-	mV
Luminance Amplitude Error		-	-	10	%
Line-to-Line Luminance Amplitude Deviation (PAL)		-	3.0	-	mVpp
Chrominance Amplitude Error	2 (@ 75 Ω load)	-	-	10	%
Line-to-Line Chroma Amplitude Deviation (PAL)		-	< 14	-	mVpp
Chrominance Phase Error		-	-	10	Degrees
Line-to-Line Chrominance Phase Error (PAL)		-	< 5.0	-	
Black Level (RGB at Black during Blanking Intervals)		-	500	-	mV
Sync Tip Clamp Level above Ground		120	200	280	

MC13077

ELECTRICAL CHARACTERISTICS (continued) ($T_A = 25^\circ\text{C}$, $V_{CC} = 5.0\text{ Vdc}$)

Characteristic	Pin	Min	Typ	Max	Unit
Luma S-Video Output					
Sync Amplitude		240	281	320	mVpp
Line-to-Line Sync Amplitude Deviation (PAL)	3	-	7.0	-	mV
Luminance Amplitude Error	(@ 75 Ω load)	-	-	10	%
Line-to-Line Luminance Amplitude Deviation (PAL)		-	3.0	-	mVpp
Black Level		-	500	-	mV
Sync Tip Clamp Level above Ground		120	200	280	
Chroma S-Video Output					
Chrominance Amplitude Error		-	-	10	%
Line-to-Line Chrominance Amplitude Deviation (PAL)	4	-	< 14	-	mVpp
Chrominance Phase Error	(@ 75 Ω load)	-	-	10	Degrees
Black Level		-	500	-	mV

Figure 1. Test Circuit

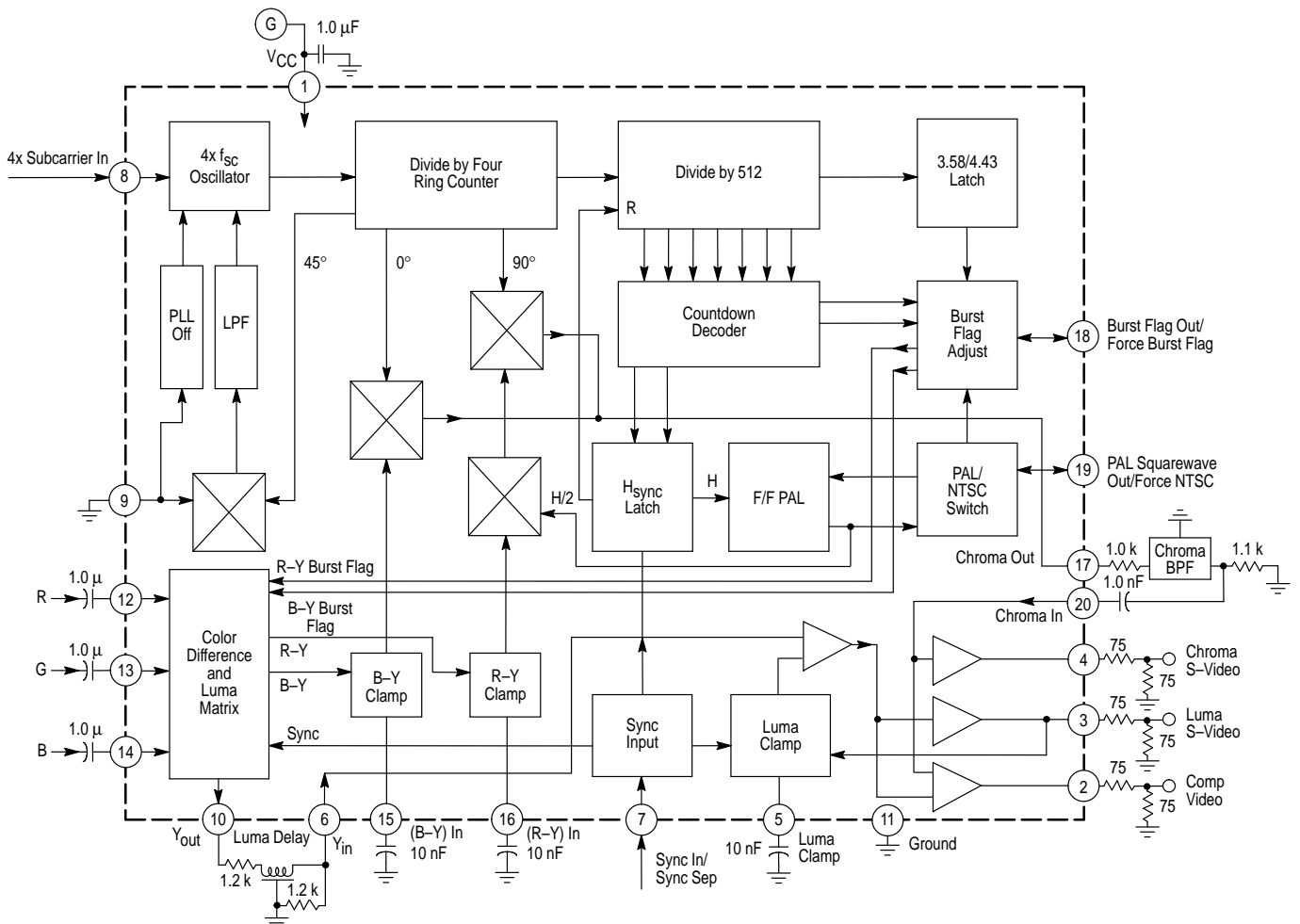

MC13077

PIN DESCRIPTIONS

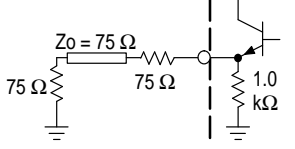
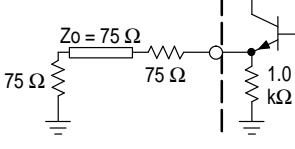
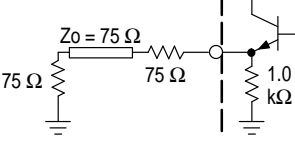
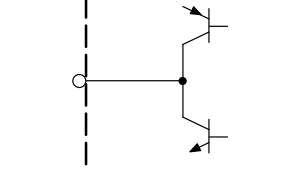
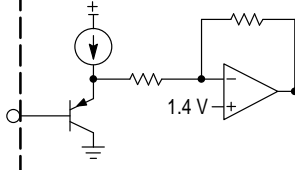
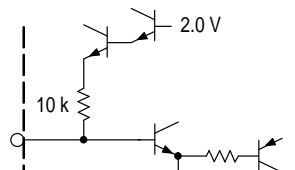
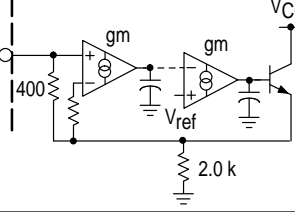
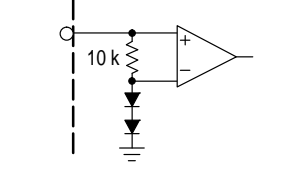
Pin	Symbol	Internal Equivalent Schematic	Description	Expected Waveforms
1	V _{CC}		Supply Voltage	+ 5.0 Vdc ±10%
2	Comp Video		Composite Video output. The external 75 Ω series resistor determines the impedance of the output. The output will drive a 75 Ω load through a 75 Ω coax.	1.0 Vpp (75% Color Saturation), 1.23 Vpp (100% Color Saturation) at the 75 Ω load.
3	Luma S-Video		Luminance S-Video output. The external 75 Ω series resistor determines the impedance of the output. The output will drive a 75 Ω load through a 75 Ω coax.	1.0 Vpp with sync (100% output) at the 75 Ω load.
4	Chroma S-Video		Chrominance S-Video output. The external 75 Ω series resistor determines the impedance of the output. The output will drive a 75 Ω load through a 75 Ω coax.	885 mVpp (100% output) when at the 75 Ω load.
5	Luma Clamp		Luminance Output Clamp storage capacitor. A 0.01 μF capacitor should be connected from this pin to ground.	3.4 Vdc.
6	Y _{In}		Luminance input from the delay line. The delayed Luma from Pin 10 is applied at this pin.	500 mVpp of Composite Luma when 100% saturated RGB inputs are applied.
7	Sync In/ Sync Sep		Composite Sync input. Negative going sync should be applied at this pin. The input has a threshold of 1.4 V.	The peak voltage may not exceed V _{CC} . Minimum voltage should not be less than 0 V. See Figure 2 for input requirements.
8	4x f _{SC} Xtal /4x f _{SC} In		Four times Subcarrier Frequency Crystal Oscillator pin. This pin provides for the connection of the oscillator resonant element. Pin may also be driven directly with a 4x subcarrier signal.	300 to 600 mVpp 4x subcarrier input if the pin is being externally driven. Approximately 40 mVpp, if a crystal is being used.
9	3.58/ 4.43 MHz In/PLL Off		External Subcarrier Input. This pin provides an input to a Phase Detector and PLL and allows phase-lock of the 4x oscillator to an external subcarrier reference. To disable the PLL, this pin should be grounded. 400 Hz of pull-in and lock-in range is possible with a crystal.	0.10 to 3.0 Vpp (AC coupled) of subcarrier to phase-lock 4x oscillator or grounded to disable the PLL.

MC13077

PIN DESCRIPTIONS (continued)

Pin	Symbol	Internal Equivalent Schematic	Description	Expected Waveforms
10	Y _{Out}		Luminance Delay Line Drive Output. A delay should be inserted between this pin and Pin 6 to match the delay incurred by the Chroma.	1.0 V _{pp} with sync (100% saturated Color Bar output).
11	Gnd		Ground	Ground
12	Red _{In}		Red Video input.	0.7 V _{pp} AC coupled (100% Color Bars).
13	Green _{In}	See Pin 12	Green Video input.	0.7 V _{pp} AC coupled (100% Color Bars).
14	Blue _{In}	See Pin 12	Blue Video input.	0.7 V _{pp} AC coupled (100% Color Bars).
15	B–Y Clamp		B–Y Clamp storage capacitor. A 0.01 μF capacitor should be connected from this pin to ground, unless the pin is used as an input.	If not used as an input the pin is clamped during sync to 2.4 V _{dc} . Can be used as a B–Y input (AC coupled, 350 mV _{pp} , 100% color saturation). Burst Flag, if disabled at Pin 18, must be inserted here with the following signal levels; –170 mV (NTSC), –121 mV (PAL).
16	R–Y Clamp		R–Y Clamp storage capacitor. A 0.01 μF capacitor should be connected from this pin to ground, unless the pin is used as an input.	If not used as an input the pin is clamped during sync to 2.4 V _{dc} . Can be used as a R–Y input (AC coupled, 490 mV _{pp} , 100% color saturation). Burst Flag, if disabled at Pin 18, must be inserted here with the following signal level; +121 mV for PAL.
17	Chroma Out		Chroma Bandpass Drive Output.	2.8 V _{pp} (100% Color Bars)
18	Burst Flag Out/Force Burst Flag		Burst Flag Output Disable and Force pin. If left unconnected, internally generated color burst will appear at Pins 2 and 4. Burst Flag will appear at this pin (18). If grounded, the Burst Flag will be disabled. If externally driven from another source of burst flag, the internal flags will be overridden.	1.8 V _{pp} burst flag pulses if unconnected.
19	PAL Square- wave Out/Force NTSC		PAL/NTSC system switch. If grounded, the MC13077 will encode NTSC, and if left open, PAL.	In PAL mode, a PAL squarewave appears at this pin, the phase of which can be reset by momentarily forcing the pin to ground during the high state of the squarewave.
20	Chroma In		Chroma Bandpass input. Output from chroma bandpass filter should be applied at this pin.	1.4 V _{pp} (100% Color Bars) with bandpass filter and 1.0 kΩ matching resistors.

FUNCTIONAL DESCRIPTION

Composite Sync Input

Other than the component video inputs to be encoded, only Composite Sync is required for encoding the components into a composite signal compatible with either the NTSC or PAL standard. The Composite Sync input is used internally for determining which standard to encode to, for driving the black level clamps, and to set the timing of the composite sync in the outputs.

The Composite Sync/Sync Separator input was designed to accept AC or DC coupled inputs making it possible to drive the sync input from a variety of sources. An interesting note is that composite video can also be used for sync input. The threshold of the sync input is 1.4 Vdc. Figure 2 shows the requirements for sync input.

Figure 2. Sync Input Amplitude Requirements

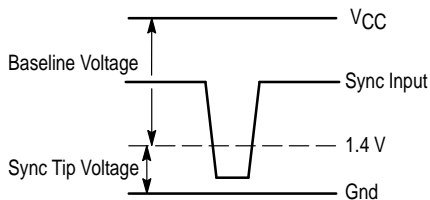

Both serrated and block vertical sync can be used for NTSC applications. PAL applications require a serrated vertical sync. The serrations at the horizontal rate trigger the PAL flip-flop to generate the swinging burst.

Even though the sync input of the MC13077 is well suited for TTL interface, some functions of the IC are susceptible to the high energy present in such signals and may be disturbed. This disturbance may take the form of a noise spike in the video outputs and/or a disturbance of the 4x oscillator resulting in an incorrect encoding of the chroma information. Therefore, it is recommended that if TTL or other fast-edged inputs are going to be used for the sync input, then either the amplitude and/or the edge speed of the sync input pulse should be reduced. 300 mVpp of sync without a reduction of edge speed has to be shown to produce disturbance free operation. Also, a sync input of 4.0 Vpp and edge rates of 225 ns have been shown to produce similar results. Figure 3 shows a recommended coupling circuit for TTL type composite sync.

Figure 3. TTL Sync Input Circuit

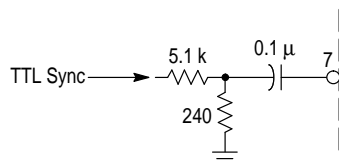

Luma and Color Difference Clamps

Clamping for the MC13077 occurs once every horizontal line during sync. The absence of color creates a color difference component voltage of zero, this null is used to generate a reference voltage for black in the video outputs.

The clamp capacitors at Pins 5, 15 and 16 are used to store the reference voltage during the line period.

RGB Inputs

To encode RGB, the component video inputs (Pins 12, 13, 14) are applied to the Luma (Y) and color difference (R–Y, B–Y) matrix. The color difference signals are then conditioned by Sallen–key low pass filters ($f_{-3dB} = 4.0$ MHz). The inputs are designed so that 700 mVpp RGB provides 100% color saturation.

The first color difference component (R–Y) is created by matrixing the RGB components with the following weights:

$$R-Y = 0.70R - 0.59G - 0.11B \quad (1)$$

The second color difference signal (B–Y) is created in a similar fashion by the equation:

$$B-Y = 0.89B - 0.59G - 0.30R \quad (2)$$

These two components then receive burst flag before being modulated by the color subcarrier to create composite chroma.

The luma is also the result of a weighted matrixing of the RGB components. The components and corresponding weights are:

$$Y = 0.30R + 0.59G + 0.11B \quad (3)$$

Composite sync is then added to the result of Equation 3 to create composite luma.

The luma information thus created must be eventually recombined with the chroma information. However, since the chroma information created by Equations 1 and 2 is filtered internally before being modulated then bandlimited externally, the resultant encoded chroma experiences a group delay that is the sum of the delay imposed by the internal and external filtering. So, the composite luma is output at Pin 10 so that an external delay can be inserted in the path to match the delay incurred by the composite chroma. The delayed composite luma is then input back into the MC13077 at Pin 6.

Color Difference Inputs

If the MC13077 is intended to encode color difference signals (YUV or Y, R–Y, B–Y), it becomes necessary to bypass the color difference and luma matrix circuitry. This can be accomplished by inputting directly to the color modulators the color difference signals. 491 mVpp and 349 mVpp should be input to the R–Y and B–Y Clamp pins (Pin 16 and Pin 15) respectively, to achieve 100% color saturation in the composite video output. The luma information can be input in two ways. The luma can be input directly into the RGB inputs (700 mVpp without sync), or through the delay line (1.0 Vpp with sync, sync tip-to-peak white) in which case the RGB inputs should be cap-coupled to ground. In either case, composite sync still needs to be input to the MC13077 at Pin 7 (see Figures 11, 12 and 13).

If the R–Y and B–Y inputs also have burst flag, it can also be input along with the color difference signals at these pins. Of course, now since the color difference modulator pre-filtering is circumvented, the delay for the luma information should be matched only to the delay of the bandpass filter.

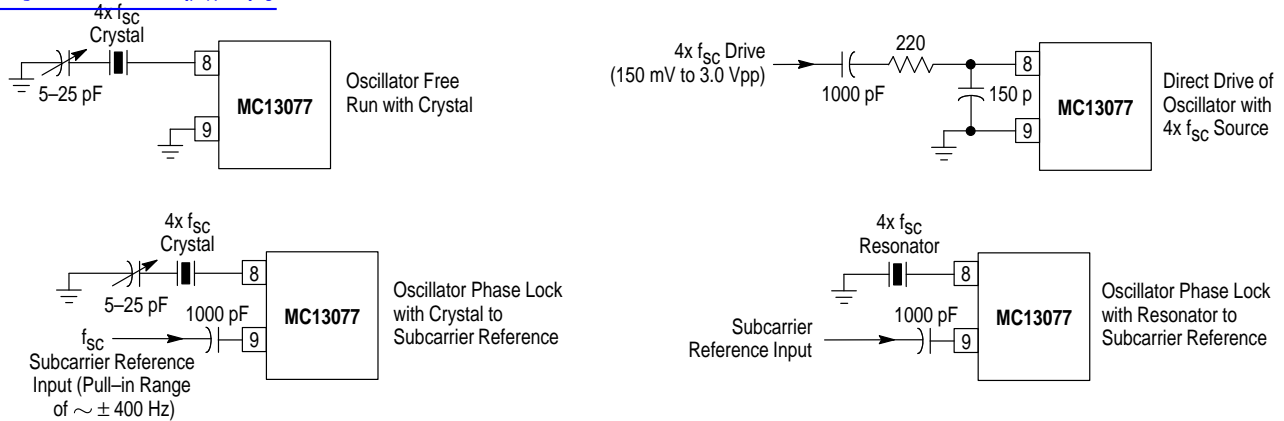
[查询"MC13077"供应商](#)
Figure 4. Versatility of the 4x f_{SC} Oscillator

4X Subcarrier Oscillator

To encode the color difference components, an accurate and reliable subcarrier source is required. The MC13077 has an on-chip single pin oscillator that will free-run with a 4x f_{SC} crystal, phase-lock to an external subcarrier reference with a 4x f_{SC} crystal or resonator, or be driven externally from a 4x f_{SC} source. If the 4x f_{SC} oscillator is going to be free run, the subcarrier input (Pin 9) should be grounded. If the 4x f_{SC} oscillator is going to be phase-locked to an external subcarrier source, the external reference should be capacitor-coupled to Pin 9. If the 4x f_{SC} oscillator is going to be driven externally, Pin 8 should be driven from a network that increases the impedance of the source at frequencies capable of producing off-frequency oscillations. The 4x f_{SC} subcarrier source, thus being defined, makes it possible to produce accurate quadrature subcarriers for the modulators. The 4x source is internally divided by a ring counter to produce the quadrature subcarrier signals. These signals in turn are provided to the color difference modulators to produce the modulated chroma. The oscillator was designed so that if a crystal is chosen as the resonant element of the 4x oscillator, the crystal specifications would be common. Crystal specifications for an adequate crystal are shown in 1

Table 1. Crystal Specifications

Frequency:	14.31818 MHz (NTSC) 17.734475 MHz (PAL)
Mode:	Fundamental
Frequency Tolerance (@25°C),	40 ppm
Frequency Tolerance df/dfo (0° – 70°C),	40 ppm
Load Capacitance:	20 pF
ESR:	50 Ω
C1 (Internal Series Capacitance),	15 pF

This crystal is a common variety and is specified as a parallel resonant.

Burst Flag Decoding

In order to encode to either NTSC or PAL compatibility, the MC13077 must first determine which is the intended standard. The MC13077 accomplishes this with an internal decode using the sync input and the output of the divide by 4 ring counter. Internally, the Sync separator circuitry provides an output that is sampled by the subcarrier signal from the

ring counter. The result is an internal sync representative of externally input sync but synchronized to the internal subcarrier signal. This signal provides a reset for an internal 9-bit counter that provides divisions of the subcarrier signal from the ring counter at powers of 2 (i.e. 2¹, 2², 2³, ..., 2⁹ = 512). The eighth bit of the counter gives the output, f_{SC} ÷ 256. The decision to provide burst gate timing for PAL or NTSC is based upon the state of this output after one period of the horizontal sync. Figure 5 shows the relationship between the clock and the eighth bit of the counter.

Triggering of the burst PAL flip-flop due to equalizing pulses is also inhibited by the decode circuitry. This is done by counting out beyond a half line interval before generating burst flag.

If the MC13077 is encoding 525/60 component video to NTSC and the MC13077 is generating the burst flag, the start of burst will occur 18 counts after the leading edge of sync has been sampled, and will continue until nine cycles of burst have occurred. Since the reset pulse of the 9-bit counter has a resolution of 1.0/f_{SC}, this implies that the start of burst will occur 5.17 ± 0.1397 μs after the leading edge of sync and also that the start (and end) of burst may differ by as much as 279.4 ns from line-to-line. If the MC13077 is encoding 625/50 to PAL, the subcarrier frequency will be 4.43361875 MHz and that implies a resolution of 225.5 ns for the burst position. For PAL encoding, 24 counts of the subcarrier are necessary before burst is initiated. So ten cycles of subcarrier will occur 5.53 ± 0.1128 μs after the leading edge of sync. After the timing of the burst gate is selected, the burst gate envelope is added to the color difference components.

Another alternative to the internal determination of burst flag is the external input of burst flag. This allows the user to externally define the exact timing and duration of color burst. If external burst flag is available, it can be inserted at Pin 18. The threshold level is nominally V_{CC}/2 and the input should not exceed V_{CC}. Burst will begin when the leading edge of the burst flag input exceeds V_{CC}/2 and will stop when it falls below V_{CC}/2. If it is desired to disable the burst flag, Pin 18 can be pulled low. It is also possible to insert burst flag with the R–Y and B–Y components. This is done at the clamp pins with the respective color difference inputs with the internal burst flag generation disabled (Pin 18 grounded).

Figure 5. Relationship Showing the Counts of a 3.58 MHz Clock versus a 4.43 MHz Clock at the End of a Horizontal Period

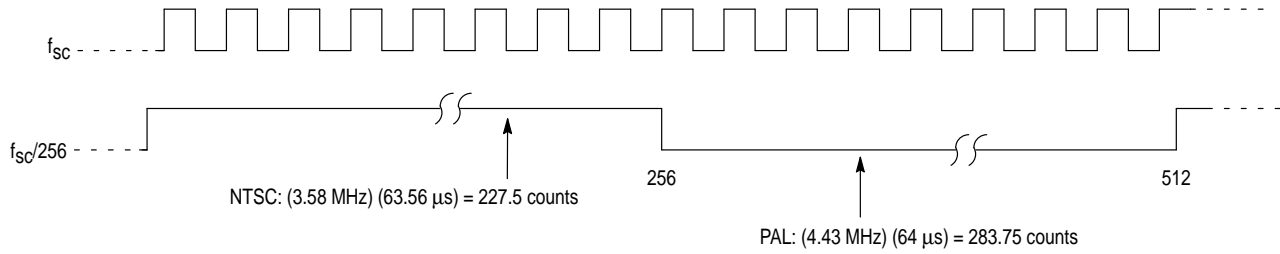

Chroma Band Limiting and Luma Delay

Once the color difference and burst flag envelopes have been modulated, the two components are internally summed and applied to an output buffer that will drive the external bandpass circuitry before entering the chip again at Pin 20. The sum of the color difference modulators produces an output that is high in harmonic content. For this reason, and to reduce the possibility of cross color, a chroma bandpass transformer is used to band-limit the chroma. Suggested bandpass filters and specifications for NTSC and PAL are shown in Figure 6a and 6b. For each of these filters,

approximately 300 ns of group delay is experienced by the filtered chroma. There is also an internal delay on the order of 100 ns due to internal filtering that must be considered. Thus a 400 ns luma delay line is used to equalize the timing of the luma and the chroma. Suitable 400 ns delay lines are the TOKO H321LNP-1436PBAB and the TDK DL122401D-1533. The delay of the luma channel is inserted between Pins 10 and 6. Pin 10 is the buffered output of the luma from the RGB matrix. This output is capable of driving the external passive delay line with no external gain or buffering required.

Figure 6a. Group Delay and Magnitude Response of the TOKO Bandpass Filter Intended for NTSC Applications

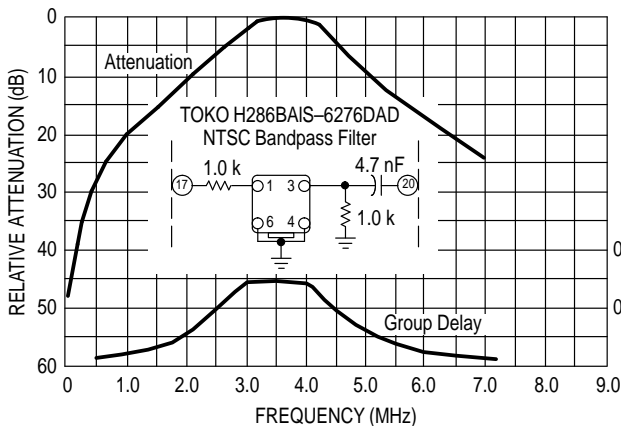
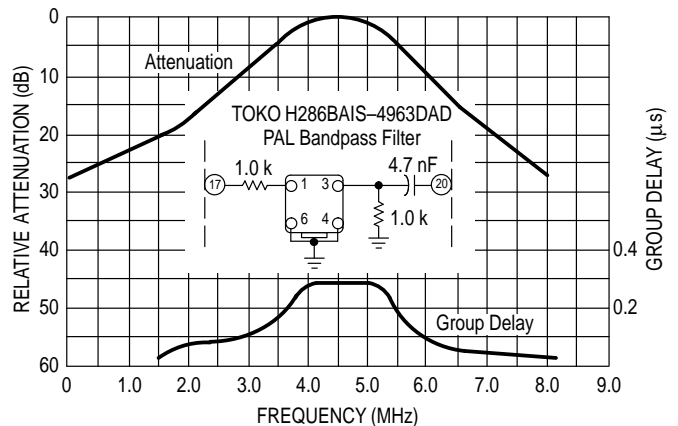

Figure 6b. Group Delay and Magnitude Response of the TOKO Bandpass Filter Intended for PAL Applications



Characteristics of TOKO Bandpass Filter (H286BAIS – 6276DAD)

Frequency (MHz)	Attenuation (dB)	Group Delay (µs)
2.0	8.0 (min)	0.12
2.8	3.0 ± 3.0	0.25
3.58	Ins. Loss 3.5 (max)	0.290 ± 0.030
4.3	3.0 ± 3.0	0.24
6.2	15 (min)	0.05

Characteristics of TOKO Bandpass Filter (H286BAIS – 4963DAD)

Frequency (MHz)	Attenuation (dB)	Group Delay (µs)
2.50	10 (min)	0.075
3.73	3.0 ± 3.0	0.24
4.43	Ins Loss 2.0 (max)	0.295 ± 0.035
5.13	3.0 ± 3.0	0.24
6.50	12 (min)	0.05

Chroma Encoding

When encoding to PAL, the color difference components is performed by two double-balanced mixers that are driven from quadrature signals provided by an internal ring counter. The quadrature signals are derived from a ring counter that is driven by the 4x oscillator, and which makes highly accurate quadrature angles possible.

If PAL encoding is selected, negative burst flag envelope is provided to both B-Y and R-Y components equally, then the R-Y envelope phase is switched positive and negative from line-to-line to provide the PAL alternating burst phase characteristic. An internal flip-flop that provides the internal $f_H/2$ switching is enabled by opening the connection at Pin 19. If enabled, the pin will exhibit the internally generated half line frequency squarewave. If it is desired to reverse the sense of the PAL swinging burst, it can be done at this pin by pulling Pin 19 low when the squarewave is high. The component envelopes with the proper PAL burst phase are then modulated to produce the composite chroma.

If the MC13077 is encoding to NTSC, only the B-Y color difference component is provided a negative burst flag. This envelope when modulated results in the characteristic -180° phase difference between the color burst and the subcarrier for the B-Y component. Pin 19 should be grounded for NTSC operation to disable the PAL flip-flop.

Video Outputs

After being filtered, the composite chroma is recombined with the composite luma information for the Composite Video output. The composite chroma and composite luma components are also kept separate and buffered for the chroma S-Video and luma S-Video outputs. The video outputs are provided with low impedance emitter-follower stages and, therefore, require an external 75 Ω impedance determining series resistor (see Figure 7). The outputs are designed to drive a 75 Ω load through the external 75 Ω series resistor.

The Composite Video output will provide 1.23 Vpp of video (sync tip-to-peak chroma) for 100% saturated video at the 75 Ω load. Luma S-Video will be 1.0 Vpp (sync tip-to-peak white) at the 75 Ω load and the Chroma S-Video output will provide 885 mVpp at the 75 Ω load.

Figure 7. Composite S-Luma and S-Chroma Video Outputs

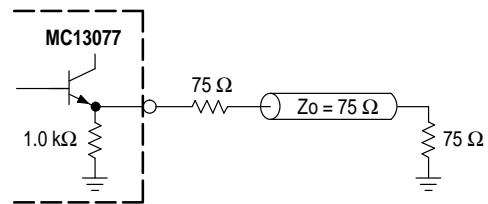

APPLICATIONS INFORMATION

Figures 8 through 13 are application examples showing the versatility of the MC13077.

Figure 8. Standard Encoder Application with RGB Inputs and Phase-Locked Subcarrier

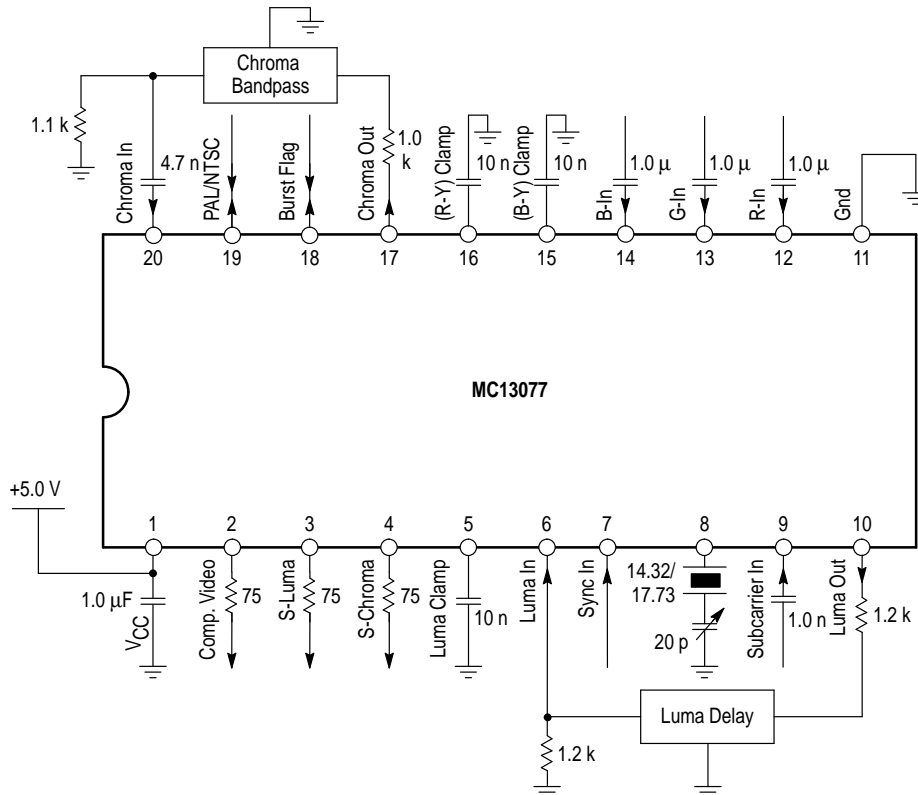

[查询"MC13077"供应商](#)

Figure 9. Encoder with RGB Inputs and Unlocked Subcarrier

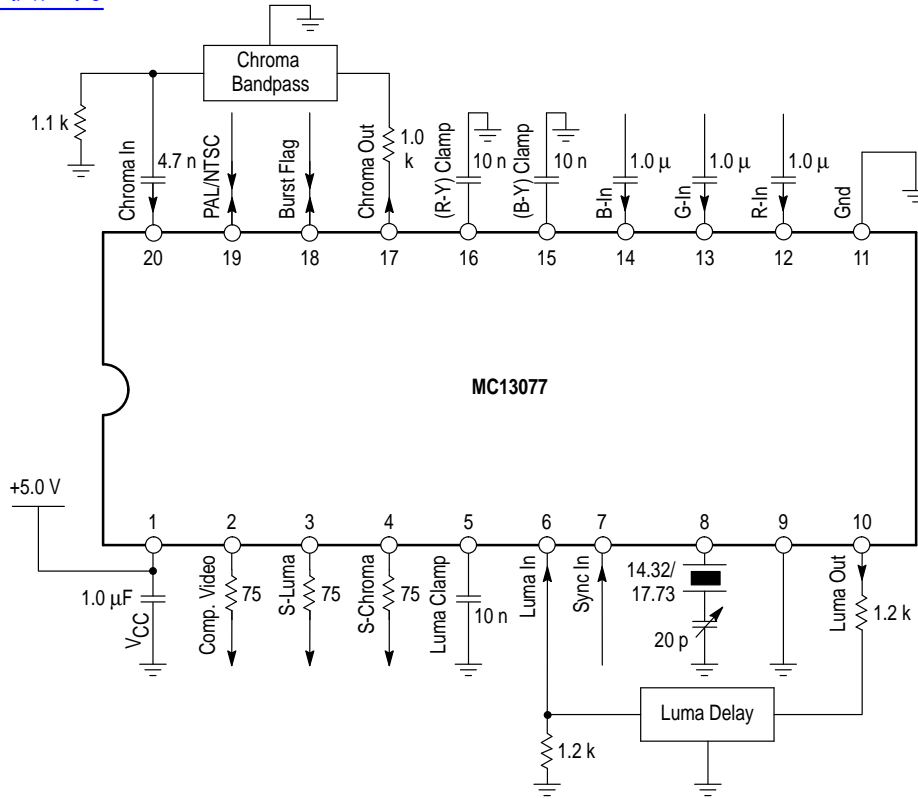
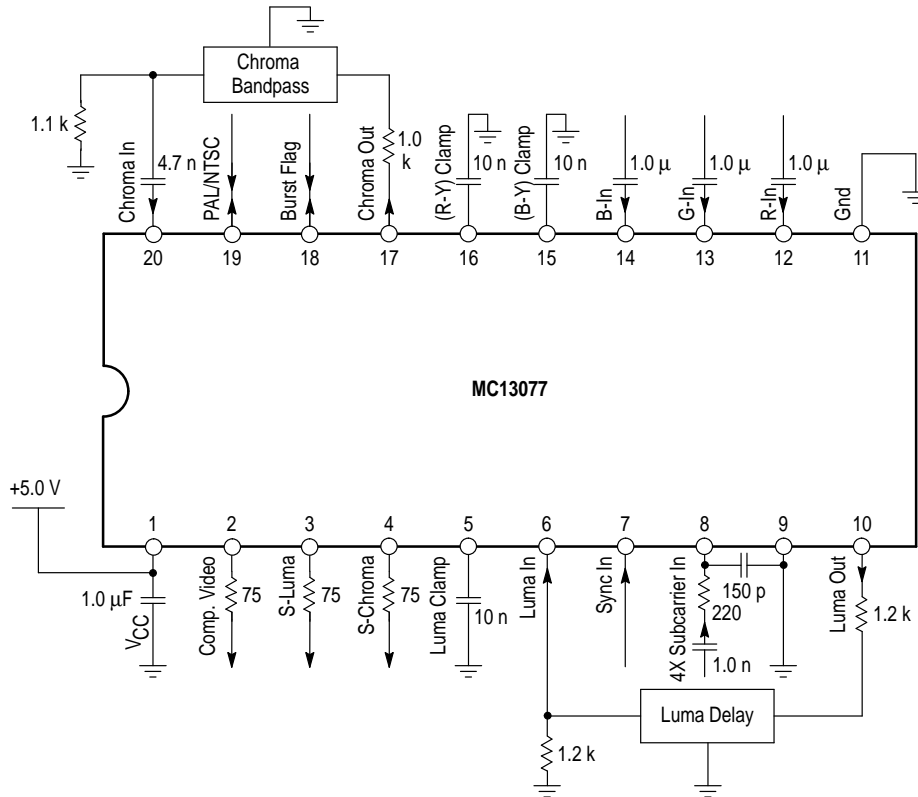

Figure 10. Encoder with RGB Inputs and 4x Subcarrier Drive



MC13077

[查询"MC13077"供应商](#)

Figure 11. Encoder with Luma and Color Difference Inputs Using Phase-Locked Subcarrier

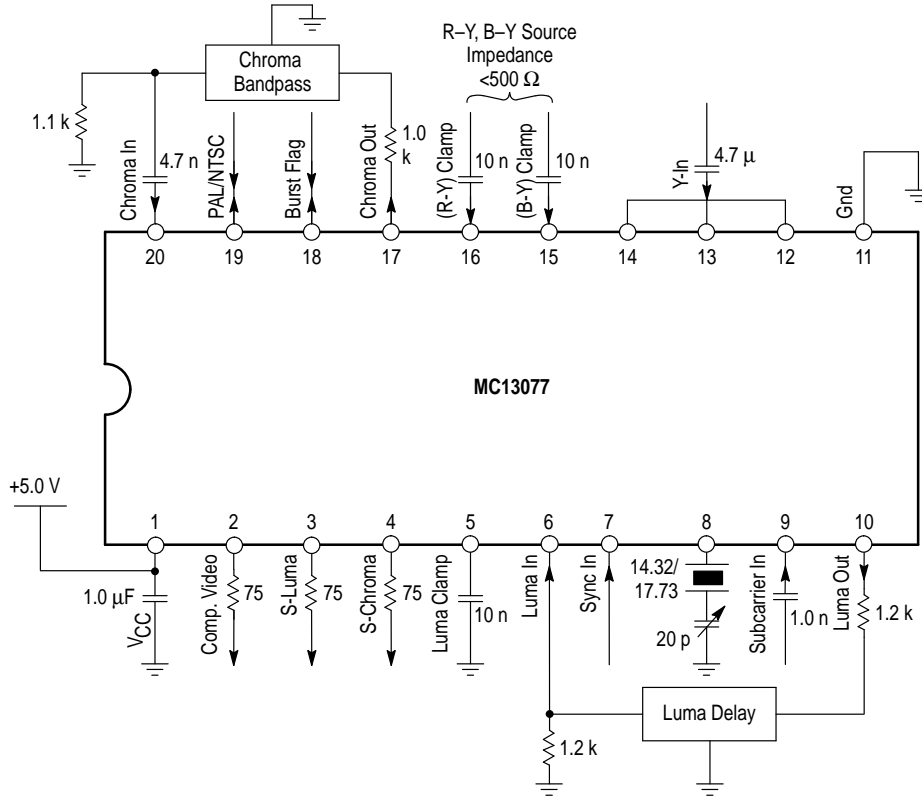
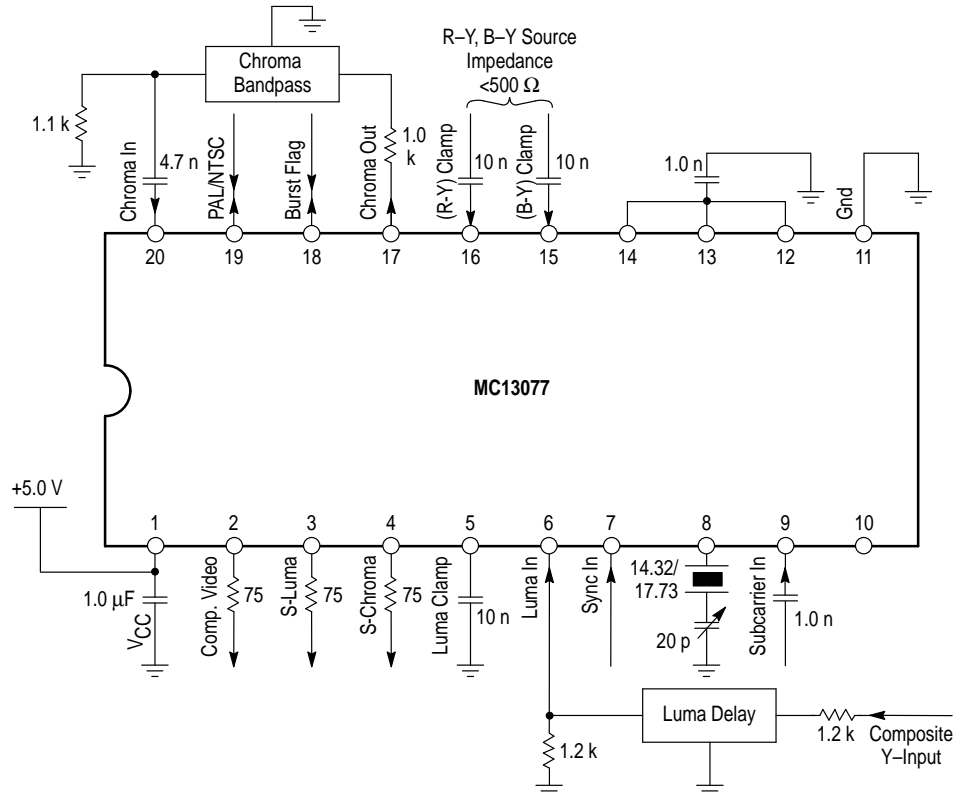
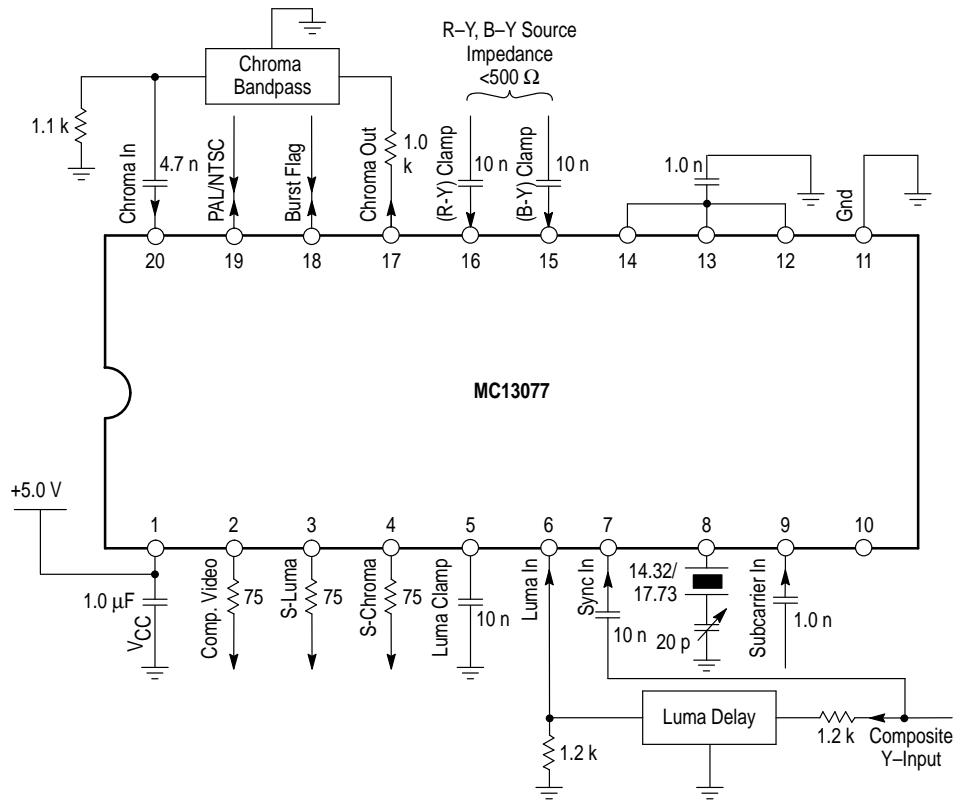

Figure 12. Encoder with Composite Luma and Color Difference Inputs Using Phase-Locked Subcarrier



MC13077

Figure 13. Encoder with Composite Luma and Color Difference Inputs
[查询"MC13077"供应商](#) Using the Sync Separator and Having Phase-Locked Subcarrier



Recommended Vendors

Bandpass Filters and Delay Lines

TOKO America Inc.
 1250 Feehanville Drive
 Mt. Prospect, IL 60056

(708) 297-0070
 (708) 699-7864 (fax)

Delay Lines

TDK Corp. of America
 1600 Feehanville Drive
 Mt. Prospect, IL 60056

(708) 803-6100

Crystals

Fox Electronics
 5570 Enterprise Pkwy
 Ft. Myers, FL 33905

(813) 693-0099

Standard Crystal Corporation
 9940 E. Baldwin Place
 El Monte, CA 91731

(818) 443-2121

MC13077

OUTLINE DIMENSIONS

[查询"MC13077"供应商](#)

P SUFFIX PLASTIC PACKAGE CASE 738-03 ISSUE E

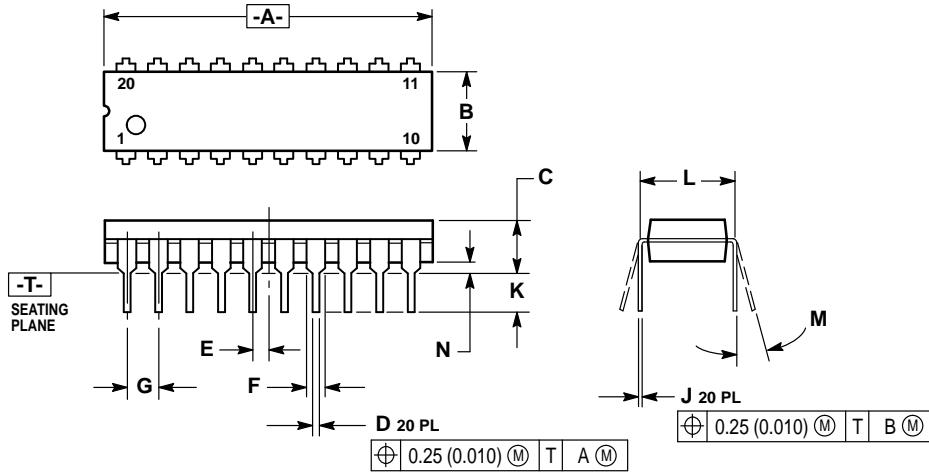

NOTES:

1. DIMENSIONING AND TOLERANCING PER ANSI Y14.5M, 1982.
2. CONTROLLING DIMENSION: INCH.
3. DIMENSION L TO CENTER OF LEAD WHEN FORMED PARALLEL.
4. DIMENSION B DOES NOT INCLUDE MOLD FLASH.

DIM	INCHES		MILLIMETERS	
	MIN	MAX	MIN	MAX
A	1.010	1.070	25.66	27.17
B	0.240	0.260	6.10	6.60
C	0.150	0.180	3.81	4.57
D	0.015	0.022	0.39	0.55
E	0.050 BSC		1.27 BSC	
F	0.050	0.070	1.27	1.77
G	0.100 BSC		2.54 BSC	
J	0.008	0.015	0.21	0.38
K	0.110	0.140	2.80	3.55
L	0.300 BSC		7.62 BSC	
M	0°	15°	0°	15°
N	0.020	0.040	0.51	1.01

DW SUFFIX PLASTIC PACKAGE CASE 751D-04 (SO-20L) ISSUE E

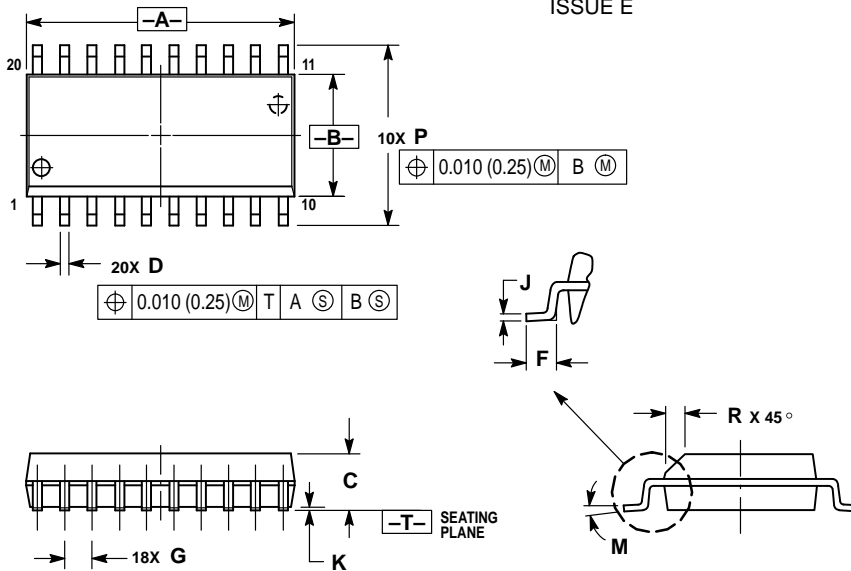

NOTES:

1. DIMENSIONING AND TOLERANCING PER ANSI Y14.5M, 1982.
2. CONTROLLING DIMENSION: MILLIMETER.
3. DIMENSIONS A AND B DO NOT INCLUDE MOLD PROTRUSION.
4. MAXIMUM MOLD PROTRUSION 0.150 (0.006) PER SIDE.
5. DIMENSION D DOES NOT INCLUDE DAMBAR PROTRUSION. ALLOWABLE DAMBAR PROTRUSION SHALL BE 0.13 (0.005) TOTAL IN EXCESS OF D DIMENSION AT MAXIMUM MATERIAL CONDITION.

DIM	MILLIMETERS		INCHES	
	MIN	MAX	MIN	MAX
A	12.65	12.95	0.499	0.510
B	7.40	7.60	0.292	0.299
C	2.35	2.65	0.093	0.104
D	0.35	0.49	0.014	0.019
F	0.50	0.90	0.020	0.035
G	1.27 BSC		0.050 BSC	
J	0.25	0.32	0.010	0.012
K	0.10	0.25	0.004	0.009
M	0°	7°	0°	7°
P	10.05	10.55	0.395	0.415
R	0.25	0.75	0.010	0.029

[查询"MC13077"供应商](#)

Motorola reserves the right to make changes without further notice to any products herein. Motorola makes no warranty, representation or guarantee regarding the suitability of its products for any particular purpose, nor does Motorola assume any liability arising out of the application or use of any product or circuit, and specifically disclaims any and all liability, including without limitation consequential or incidental damages. "Typical" parameters which may be provided in Motorola data sheets and/or specifications can and do vary in different applications and actual performance may vary over time. All operating parameters, including "Typicals" must be validated for each customer application by customer's technical experts. Motorola does not convey any license under its patent rights nor the rights of others. Motorola products are not designed, intended, or authorized for use as components in systems intended for surgical implant into the body, or other applications intended to support or sustain life, or for any other application in which the failure of the Motorola product could create a situation where personal injury or death may occur. Should Buyer purchase or use Motorola products for any such unintended or unauthorized application, Buyer shall indemnify and hold Motorola and its officers, employees, subsidiaries, affiliates, and distributors harmless against all claims, costs, damages, and expenses, and reasonable attorney fees arising out of, directly or indirectly, any claim of personal injury or death associated with such unintended or unauthorized use, even if such claim alleges that Motorola was negligent regarding the design or manufacture of the part. Motorola and  are registered trademarks of Motorola, Inc. Motorola, Inc. is an Equal Opportunity/Affirmative Action Employer.

Mfax is a trademark of Motorola, Inc.

How to reach us:

USA/EUROPE/Locations Not Listed: Motorola Literature Distribution;
P.O. Box 5405, Denver, Colorado 80217. 303-675-2140 or 1-800-441-2447

JAPAN: Nippon Motorola Ltd.: SPD, Strategic Planning Office, 4-32-1,
Nishi-Gotanda, Shinagawa-ku, Tokyo 141, Japan. 81-3-5487-8488

Mfax™: RMFAX0@email.sps.mot.com – TOUCHTONE 602-244-6609
– US & Canada ONLY 1-800-774-1848

ASIA/PACIFIC: Motorola Semiconductors H.K. Ltd.; 8B Tai Ping Industrial Park,
51 Ting Kok Road, Tai Po, N.T., Hong Kong. 852-26629298

INTERNET: <http://motorola.com/sps>

