

### FEATURES

#### DOCSIS 3.0 performance: 4 QAM carriers

##### ACLR over full band (47 MHz to 1 GHz)

- 75 dBc @  $f_{OUT} = 200$  MHz
- 72 dBc @  $f_{OUT} = 800$  MHz (noise)
- 67 dBc @  $f_{OUT} = 800$  MHz (harmonics)

##### Unequalized MER = 42 dB

#### On chip and bypassable

##### 4 QAM encoders with SRRRC filters, 16x to 512x interpolation, rate converters, and modulators

#### Flexible data interface: 4, 8, 16, or 32 bits wide with parity

#### Power: 1.6 W ( $I_{FS} = 20$ mA, $f_{DAC} = 2.4$ GHz, LVDS interface)

#### Direct to RF synthesis support with $f_s$ mix mode

#### Built-in self-test (BIST) support

- Input connectivity check
- Internal random number generator

### APPLICATIONS

#### Broadband communications systems

#### CMTS/DVB

#### Cellular infrastructure

#### Point-to-point wireless

### GENERAL DESCRIPTION

The AD9789 is a flexible QAM encoder/interpolator/upconverter combined with a high performance, 2400 MSPS, 14-bit RF digital-to-analog converter (DAC). The flexible digital interface can accept up to four channels of complex data. The QAM encoder supports constellation sizes of 16, 32, 64, 128, and 256 with SRRRC filter coefficients for all standards.

The on-chip rate converter supports a wide range of baud rates with a fixed DAC clock. The digital upconverter can place the channels from 0 to  $0.5 \times f_{DAC}$ . This permits four contiguous channels to be synthesized and placed anywhere from dc to  $f_{DAC}/2$ .

The AD9789 includes a serial peripheral interface (SPI) for device configuration and status register readback. The flexible digital interface can be configured for data bus widths of 4, 8, 16, and 32 bits. It can accept real or complex data.

The AD9789 operates from 1.5 V, 1.8 V, and 3.3 V supplies for a total power consumption of 1.6 W. It is supplied in a 164-ball chip scale package ball grid array for lower thermal impedance and reduced package parasitics. No special power sequencing is required. The clock receiver powers up muted to prevent start-up noise.

### PRODUCT HIGHLIGHTS

1. Highly integrated and configurable QAM mappers, interpolators, and upconverters for direct synthesis of one to four DOCSIS- or DVB-compatible channels in a block.
2. Low noise and intermodulation distortion (IMD) performance enable high quality synthesis of signals up to 1 GHz.
3. Flexible data interface supports LVDS for improved SFDR or CMOS input data for less demanding applications.
4. Interface is configurable from 4-bit nibbles to 32-bit words and can run at up to 150 MHz CMOS or 150 MHz LVDS double data rate (DDR).
5. Manufactured on a CMOS process, the AD9789 uses a proprietary switching technique that enhances dynamic performance.

### FUNCTIONAL BLOCK DIAGRAM

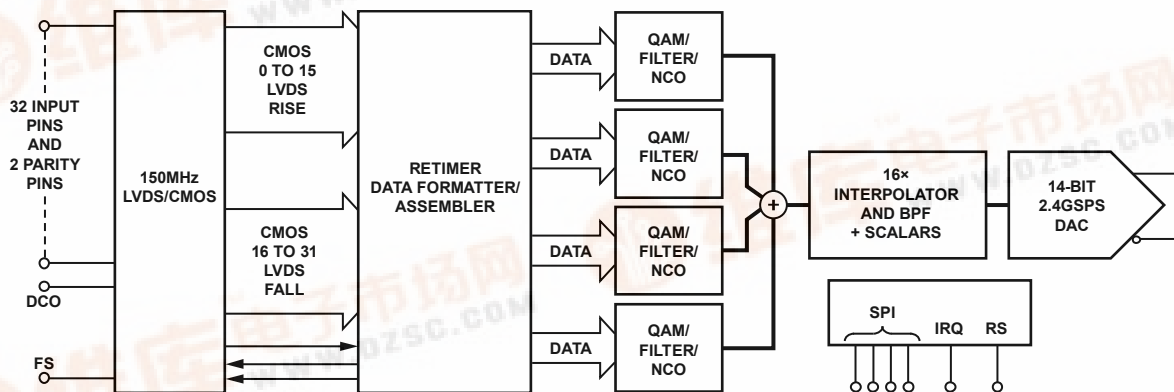

Figure 1.

07952-001

#### Rev. 0

Information furnished by Analog Devices is believed to be accurate and reliable. However, no responsibility is assumed by Analog Devices for its use, nor for any infringements of patents or other rights of third parties that may result from its use. Specifications subject to change without notice. No license is granted by implication or otherwise under any patent or patent rights of Analog Devices. Trademarks and registered trademarks are the property of their respective owners.

One Technology Way, P.O. Box 9106, Norwood, MA 02062-9106, U.S.A.

Tel: 781.329.4700

Fax: 781.461.3113

[www.analog.com](http://www.analog.com)

©2009 Analog Devices, Inc. All rights reserved.



## TABLE OF CONTENTS

Features .....	1	SPI Register Descriptions.....	29
Applications.....	1	Theory of Operation .....	39
General Description .....	1	Datapath Signal Processing.....	39
Product Highlights .....	1	Digital Block Upconverter .....	43
Functional Block Diagram .....	1	Digital Interface Modes .....	45
Revision History .....	2	Analog Modes of Operation .....	54
Detailed Functional Block Diagrams.....	3	Analog Control Registers .....	55
Specifications.....	4	Voltage Reference .....	56
DC Specifications .....	4	DAC Output Stages.....	56
Digital Specifications .....	5	Clocking the AD9789 .....	57
AC Specifications.....	6	Mu Delay Controller .....	58
Absolute Maximum Ratings.....	8	Interrupt Requests.....	61
Thermal Resistance .....	8	Recommended Start-Up Sequence .....	62
ESD Caution.....	8	Customer BIST Modes.....	63
Pin Configurations and Function Descriptions .....	9	Using the Internal PRN Generator to Test QAM Output AC Performance .....	63
Typical Performance Characteristics .....	12	Using the Internal Built-In Self-Test (BIST) to Test for Digital Data Input Connectivity.....	63
Terminology .....	22	QAM Constellation Maps .....	65
Serial Control Port.....	23	Channelizer Mode Pin Mapping for CMOS and LVDS.....	68
Serial Control Port Pin Descriptions.....	23	Outline Dimensions .....	74
General Operation of Serial Control Port.....	23	Ordering Guide .....	74
Instruction Word (16 Bits) .....	24		
MSB/LSB First Transfers.....	24		
SPI Register Map.....	27		

## REVISION HISTORY

4/09—Revision 0: Initial Version

## DETAILED FUNCTIONAL BLOCK DIAGRAMS

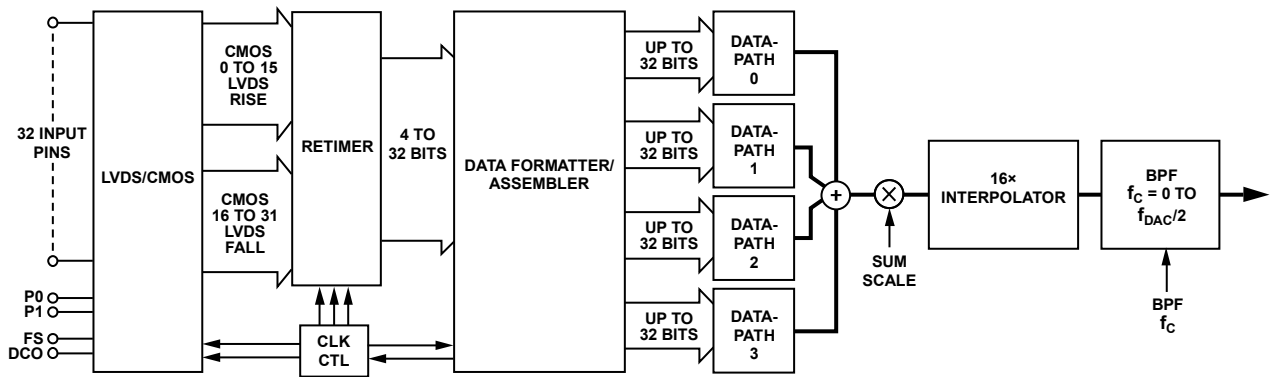

Figure 2. Digital Signal Processing Functional Block Diagram

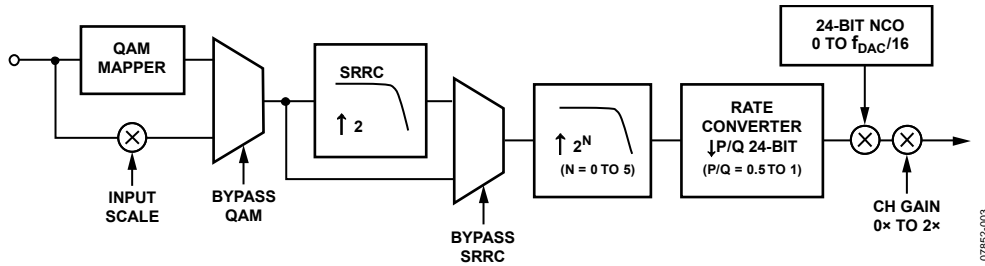

Figure 3. Channel 0 Through Channel 3 Datapath Block Detail (I and Q Paths Are Identical So Only One Is Shown)

## SPECIFICATIONS

### DC SPECIFICATIONS

AVDD33 = DVDD33 = 3.3 V, CVDD18 = DVDD18 = 1.8 V, DVDD15 = 1.5 V,  $f_{DAC} = 2.4$  GHz,  $I_{FS} = 20$  mA, unless otherwise noted.

Table 1.

Parameter	Min	Typ	Max	Unit
DAC RESOLUTION		14		Bits
ANALOG OUTPUTS				
Offset Error		6.5		% FSR
Gain Error (with Internal Reference)		3.5		% FSR
Full-Scale Output Current (Monotonicity Guaranteed)	8.66	20.2	31.66	mA
Output Compliance Range	-1.0		+1.0	V
Output Resistance		70		$\Omega$
Output Capacitance		1		pF
TEMPERATURE DRIFT				
Gain		135		ppm/ $^{\circ}$ C
Reference Voltage		25		ppm/ $^{\circ}$ C
REFERENCE				
Internal Reference Voltage		1.2		V
Output Resistance <sup>1</sup>		5		k $\Omega$
ANALOG SUPPLY VOLTAGES				
AVDD33	3.14	3.3	3.47	V
CVDD18	1.71	1.8	1.89	V
DIGITAL SUPPLY VOLTAGES				
DVDD33	3.14	3.3	3.47	V
DVDD18	1.71	1.8	1.89	V
DVDD15	1.43	1.5	1.58	V
SUPPLY CURRENTS AND POWER DISSIPATION				
$f_{DAC} = 2.4$ GSPS, $f_{OUT} = 930$ MHz, $I_{FS} = 25$ mA, Four Channels Enabled				
$I_{AVDD33}$		45		mA
$I_{DVDD18}$		72		mA
$I_{CVDD18}$		180		mA
$I_{DVDD33}$				
CMOS Interface		42		mA
LVDS Interface		16		mA
$I_{DVDD15}$		640		mA
$f_{DAC} = 2.0$ GSPS, $f_{OUT} = 70$ MHz, $I_{FS} = 20$ mA, CMOS Interface				
$I_{AVDD33}$		37.4	38.5	mA
$I_{DVDD18}$		67.3	70.5	mA
$I_{CVDD18}$		155.4	180	mA
$I_{DVDD33}$		40.3	50.7	mA
$I_{DVDD15}$ (Four Channels Enabled, All Signal Processing Enabled)		517	556	mA
$I_{DVDD15}$ (One Channel Enabled, 16 $\times$ Interpolation Only)		365	391	mA
Power Dissipation				
$f_{DAC} = 2.4$ GSPS, $f_{OUT} = 930$ MHz, $I_{FS} = 25$ mA, Four Channels Enabled				
CMOS Interface		1.7		W
LVDS Interface		1.63		W

<sup>1</sup> Use an external amplifier to drive any external load.

**DIGITAL SPECIFICATIONS**

AVDD33 = DVDD33 = 3.3 V, CVDD18 = DVDD18 = 1.8 V, DVDD15 = 1.5 V,  $f_{DAC} = 2.4$  GHz,  $I_{FS} = 20$  mA, LVDS drivers and receivers are compliant with the IEEE Std 1596.3-1996 reduced range link, unless otherwise noted.

**Table 2.**

Parameter	Min	Typ	Max	Unit
<b>CMOS DATA INPUTS (D[31:0], P0, P1)</b>				
Input Voltage High, $V_{IH}$	2.0	3.3		V
Input Voltage Low, $V_{IL}$		0	0.8	V
Input Current High, $I_{IH}$	-10		+10	$\mu$ A
Input Current Low, $I_{IL}$	-10		+10	$\mu$ A
Input Capacitance		2		pF
Setup Time, CMOS Data Input to CMOS_DCO <sup>1</sup>	5.3			ns
Hold Time, CMOS Data Input to CMOS_DCO <sup>1</sup>	-1.4			ns
<b>CMOS OUTPUTS (CMOS_FS, CMOS_DCO)</b>				
Output Voltage High, $V_{OH}$	2.4		3.3	V
Output Voltage Low, $V_{OL}$	0		0.4	V
Output Current High, $I_{OH}$		12		mA
Output Current Low, $I_{OL}$		12		mA
Maximum Clock Rate (CMOS_DCO)	150			MHz
CMOS_DCO to CMOS_FS Delay	0.28		0.85	ns
<b>LVDS DATA INPUTS (D[15:0]P, D[15:0]N, PARP, PARN)</b>				
Input Voltage Range, $V_{IA}$ or $V_{IB}$	825		1575	mV
Input Differential Threshold, $V_{IDTH}$	-100		+100	mV
Input Differential Hysteresis, $V_{IDTHH}$ , $V_{IDTHL}$		25		mV
Input Differential Input Impedance, $R_{IN}$	80		120	$\Omega$
Maximum LVDS Input Rate	150			MSPS
Setup Time, LVDS Differential Input Data to Differential DCOx <sup>2</sup>	1.41			ns
Hold Time, LVDS Differential Input Data to Differential DCOx <sup>2</sup>	0.24			ns
<b>LVDS OUTPUTS (DCOP, DCON, FSP, FSN)</b>				
DCOP, FSP = $V_{OA}$ ; DCON, FSN = $V_{OB}$ ; 100 $\Omega$ Termination				
Output Voltage High, $V_{OA}$ or $V_{OB}$			1375	mV
Output Voltage Low, $V_{OA}$ or $V_{OB}$	1025			mV
Output Differential Voltage, $ V_{OD} $	150	200	250	mV
Output Offset Voltage, $V_{OS}$	1150		1250	mV
Output Impedance, Single Ended, $R_o$	40		140	$\Omega$
$R_o$ Mismatch Between A and B, $\Delta R_o$			10	%
Change in $ V_{OD} $ Between 0 and 1, $ \Delta V_{OD} $			25	mV
Change in $V_{OS}$ Between 0 and 1, $\Delta V_{OS}$			25	mV
Output Current—Driver Shorted to Ground, $I_{SA}$ , $I_{SB}$			20	mA
Output Current—Drivers Shorted Together, $I_{SAB}$			4	mA
Power-Off Output Leakage, $ I_{XA} $ , $ I_{XB} $			10	mA
Maximum Clock Rate (DCOP, DCON)	150			MHz
DCOx to FSx Delay	0.12		0.37	ns
<b>DAC CLOCK INPUT (CLKP, CLKN)<sup>3</sup></b>				
Differential Peak Voltage	1.4	1.8		V
Common-Mode Voltage		900		mV
Maximum Clock Rate	2400			MHz
<b>SERIAL PERIPHERAL INTERFACE</b>				
Maximum Clock Rate ( $f_{SCLK}$ , $1/t_{SCLK}$ )			25	MHz
Minimum Pulse Width High, $t_{PWH}$	20			ns
Minimum Pulse Width Low, $t_{PWL}$	20			ns
Minimum SDIO and $\overline{CS}$ to SCLK Setup, $t_{DS}$		10		ns

# AD9789

[查询"AD9789"供应商](#)

Parameter	Min	Typ	Max	Unit
Minimum SCLK to SDIO Hold, $t_{DH}$		5		ns
Maximum SCLK to Valid SDIO and SDO, $t_{DV}$		20		ns
Minimum SCLK to Invalid SDIO and SDO, $t_{DNV}$		5		ns
<b>INPUTS (SDIO, SCLK, <math>\overline{CS}</math>)</b>				
Input Voltage High, $V_{IH}$	2.0	3.3		V
Input Voltage Low, $V_{IL}$		0	0.8	V
Input Current High, $I_{IH}$	-10		+10	$\mu$ A
Input Current Low, $I_{IL}$	-10		+10	$\mu$ A
<b>OUTPUTS (SDO, SDIO)</b>				
Output Voltage High, $V_{OH}$	2.4		3.6	V
Output Voltage Low, $V_{OL}$	0		0.4	V
Output Current High, $I_{OH}$		4		mA
Output Current Low, $I_{OL}$		4		mA

<sup>1</sup> See the CMOS Interface Timing section for more information.

<sup>2</sup> See the LVDS Interface Timing section for more information.

<sup>3</sup> See the Clock Phase Noise Effects on AC Performance section for more information.

## AC SPECIFICATIONS

AVDD33 = DVDD33 = 3.3 V, CVDD18 = DVDD18 = 1.8 V, DVDD15 = 1.5 V,  $f_{DAC} = 2.4$  GHz,  $I_{FS} = 20$  mA, digital scale = 0 dBFS, unless otherwise noted.

Table 3.

Parameter	Test Conditions/Comments	Min	Typ	Max	Unit
<b>DYNAMIC PERFORMANCE</b>					
Maximum Update Rate		2400			MSPS
Output Settling Time ( $t_{ST}$ )	To 0.025%		13		ns
<b>SPURIOUS-FREE DYNAMIC RANGE (SFDR)</b>					
$f_{DAC} = 2000$ MSPS					
$f_{OUT} = 100$ MHz			70		dBc
$f_{OUT} = 316$ MHz			63		dBc
$f_{OUT} = 550$ MHz			58		dBc
$f_{DAC} = 2400$ MSPS					
$f_{OUT} = 100$ MHz			70		dBc
$f_{OUT} = 316$ MHz			70		dBc
$f_{OUT} = 550$ MHz			60		dBc
$f_{OUT} = 850$ MHz			60		dBc
<b>TWO-TONE INTERMODULATION DISTORTION (IMD)</b>					
	$f_{OUT2} = f_{OUT1} + 1.25$ MHz				
$f_{DAC} = 2000$ MSPS					
$f_{OUT} = 100$ MHz			86		dBc
$f_{OUT} = 316$ MHz			73		dBc
$f_{OUT} = 550$ MHz			62		dBc
$f_{DAC} = 2400$ MSPS					
$f_{OUT} = 100$ MHz			86		dBc
$f_{OUT} = 316$ MHz			74		dBc
$f_{OUT} = 550$ MHz			66		dBc
$f_{OUT} = 850$ MHz			66		dBc
<b>NOISE SPECTRAL DENSITY (NSD)</b>					
<b>1-Channel QAM</b>					
$f_{OUT} = 100$ MHz	$f_{DAC} = 2400$ MSPS $P_{OUT} = -14.5$ dBm		-167		dBm/Hz
$f_{OUT} = 316$ MHz	$P_{OUT} = -15.5$ dBm		-166.5		dBm/Hz
$f_{OUT} = 550$ MHz	$P_{OUT} = -18$ dBm		-166.5		dBm/Hz
$f_{OUT} = 850$ MHz	$P_{OUT} = -18.5$ dBm		-166.5		dBm/Hz

Parameter	Test Conditions/Comments	Min	Typ	Max	Unit
ADJACENT CHANNEL LEAKAGE RATIO (ACLR)	$f_{DAC} = 2293.76$ MSPS measured in 6 MHz channels				
1-Channel QAM					
$f_{OUT} = 200$ MHz (Harmonics)			-76		dBc
$f_{OUT} = 200$ MHz (Noise Floor)			-82		dBc
$f_{OUT} = 500$ MHz (Harmonics)			-74.5		dBc
$f_{OUT} = 500$ MHz (Noise Floor)			-78		dBc
$f_{OUT} = 800$ MHz (Harmonics)			-69		dBc
$f_{OUT} = 800$ MHz (Noise Floor)			-78		dBc
2-Channel QAM					
$f_{OUT} = 200$ MHz (Harmonics)			-77.5		dBc
$f_{OUT} = 200$ MHz (Noise Floor)			-81		dBc
$f_{OUT} = 500$ MHz (Harmonics)			-68		dBc
$f_{OUT} = 500$ MHz (Noise Floor)			-76		dBc
$f_{OUT} = 800$ MHz (Harmonics)			-66		dBc
$f_{OUT} = 800$ MHz (Noise Floor)			-76		dBc
4-Channel QAM					
$f_{OUT} = 200$ MHz (Harmonics)			-75		dBc
$f_{OUT} = 200$ MHz (Noise Floor)			-76		dBc
$f_{OUT} = 500$ MHz (Harmonics)			-69		dBc
$f_{OUT} = 500$ MHz (Noise Floor)			-72		dBc
$f_{OUT} = 800$ MHz (Harmonics)			-67		dBc
$f_{OUT} = 800$ MHz (Noise Floor)			-72		dBc
WCDMA ACLR	$f_{DAC} = 2304$ MSPS, mix mode second Nyquist zone				
Single Carrier	$f_{OUT} = 1850$ MHz				
First Adjacent Channel			-70		dBc
Second Alternate Channel			-72.5		dBc
Third Alternate Channel			-74		dBc
Single Carrier	$f_{OUT} = 2100$ MHz				
First Adjacent Channel			-68		dBc
Second Alternate Channel			-70.4		dBc
Third Alternate Channel			-72.7		dBc
Four Carrier	$f_{OUT} = 2100$ MHz				
First Adjacent Channel			-63.5		dBc
Second Alternate Channel			-65.1		dBc
Third Alternate Channel			-66.9		dBc

## ABSOLUTE MAXIMUM RATINGS

Table 4.

Parameter	Rating
AVDD33 to AVSS	−0.3 V to +3.6 V
DVDD18 to DVSS	−0.3 V to +1.98 V
DVDD33 to DVSS	−0.3 V to +3.6 V
DVDD15 to DVSS	−0.3 V to +1.98 V
CVDD18 to AVSS	−0.3 V to +1.98 V
AVSS to DVSS	−0.3 V to +0.3 V
CLKP, CLKN to AVSS	−0.3 V to CVDD18 + 0.3 V
FS, DCO to DVSS	−0.3 V to DVDD33 + 0.3 V
CMOS and LVDS Data Inputs to DVSS	−0.3 V to DVDD33 + 0.3 V
IOUTN, IOUTP to AVSS	−1.0 V to AVDD33 + 0.3 V
I120, VREF, IPTAT to AVSS	−0.3 V to AVDD33 + 0.3 V
IRQ, $\overline{CS}$ , SCLK, SDO, SDIO, RESET to DVSS	−0.3 V to DVDD33 + 0.3 V
Junction Temperature	150°C
Storage Temperature Range	−65°C to +150°C

Stresses above those listed under Absolute Maximum Ratings may cause permanent damage to the device. This is a stress rating only; functional operation of the device at these or any other conditions above those indicated in the operational section of this specification is not implied. Exposure to absolute maximum rating conditions for extended periods may affect device reliability.

## THERMAL RESISTANCE

$\theta_{JA}$  is specified for the worst-case conditions, that is, a device soldered in a circuit board for surface-mount packages.

Table 5. Thermal Resistance

Package Type	$\theta_{JA}$	$\theta_{JB}$	$\theta_{JC}$	Unit	Notes
164-Ball CSP_BGA	25.5	14.4	6.8	°C/W	4-layer board, no vias
	24.4			°C/W	4-layer board, 4 PCB vias
	19.0			°C/W	8-layer board, 4 PCB vias
	17.2			°C/W	8-layer board, 16 PCB vias

## ESD CAUTION



**ESD (electrostatic discharge) sensitive device.** Charged devices and circuit boards can discharge without detection. Although this product features patented or proprietary protection circuitry, damage may occur on devices subjected to high energy ESD. Therefore, proper ESD precautions should be taken to avoid performance degradation or loss of functionality.



# PIN CONFIGURATIONS AND FUNCTION DESCRIPTIONS

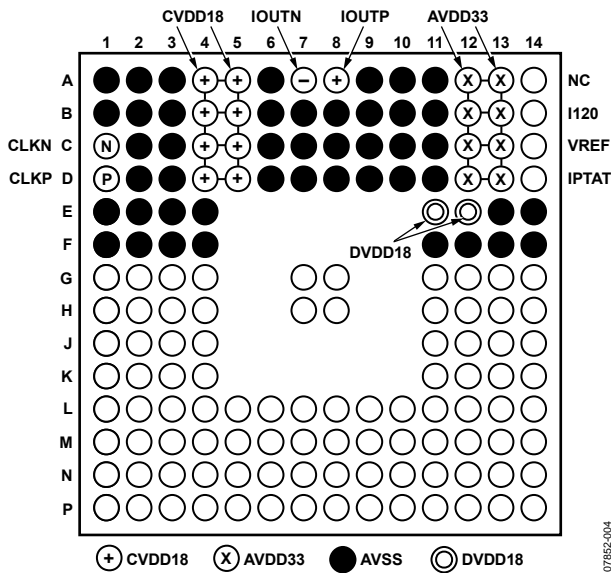

Figure 4. Clock and Analog Pins (Top View)

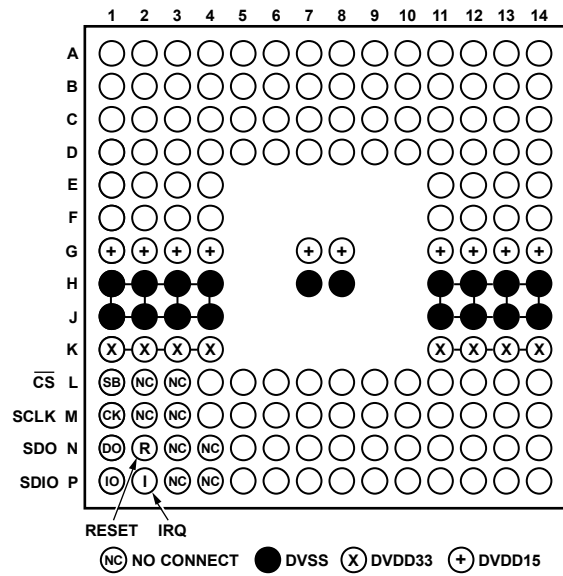

Figure 6. Digital Supply and SPI Pins (Top View)

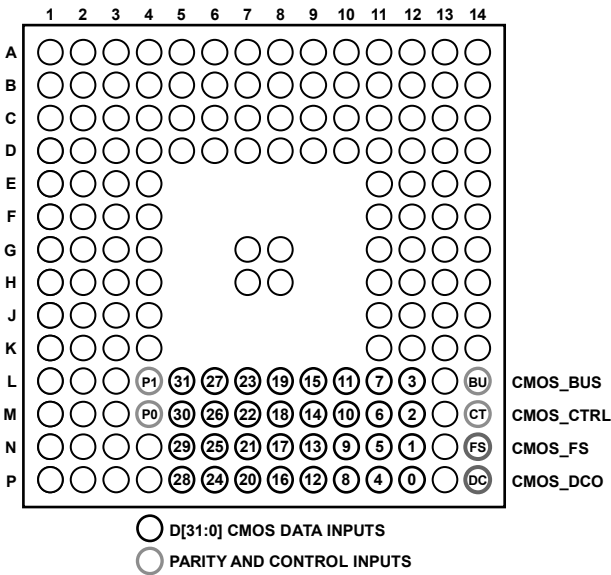

Figure 5. CMOS Mode Data Input Pins (Top View)

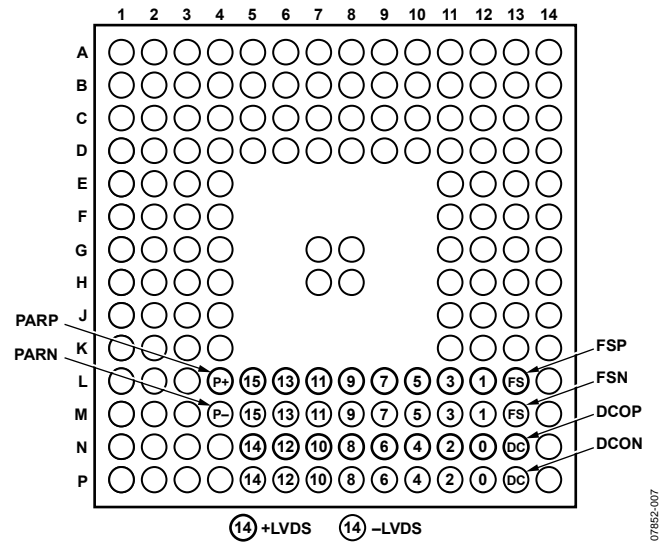

Figure 7. LVDS Mode Data Input Pins (Top View)

Table 6. Pin Function Descriptions

Pin No.	Mnemonic	Description
A1, A2, A3, A6, A9, A10, A11, B1, B2, B3, B6, B7, B8, B9, B10, B11, C2, C3, C6, C7, C8, C9, C10, C11, D2, D3, D6, D7, D8, D9, D10, D11, E1, E2, E3, E4, E13, E14, F1, F2, F3, F4, F11, F12, F13, F14	AVSS	Analog Supply Ground.
A4, A5, B4, B5, C4, C5, D4, D5	CVDD18	1.8 V Clock Supply.
A7	IOUTN	DAC Negative Output Current.
A8	IOUTP	DAC Positive Output Current.
A12, A13, B12, B13, C12, C13, D12, D13	AVDD33	3.3 V Analog Supply.
A14	NC	No Connect. Leave floating.
B14	I120	Tie this pin to analog ground with a 10 k $\Omega$ resistor to generate a 120 $\mu$ A reference current.
C1	CLKN	Negative DAC Clock Input (DACCLK).
C14	VREF	Band Gap Voltage Reference I/O. Decouple to analog ground with a 1 nF capacitor. Output impedance is approximately 5 k $\Omega$ .
D1	CLKP	Positive DAC Clock Input (DACCLK).
D14	IPTAT	Factory Test Pin. Output current, proportional to absolute temperature, is approximately 10 $\mu$ A at 25°C with a slope of approximately 20 nA/°C.
E11, E12	DVDD18	1.8 V Digital Supply.
G1, G2, G3, G4, G7, G8, G11, G12, G13, G14	DVDD15	1.5 V Digital Supply.
H1, H2, H3, H4, H7, H8, H11, H12, H13, H14, J1, J2, J3, J4, J11, J12, J13, J14	DVSS	Digital Supply Ground.
K1, K2, K3, K4, K11, K12, K13, K14	DVDD33	3.3 V Digital Supply.
L1	$\overline{CS}$	Active Low Chip Select for SPI.
L2, L3, M2, M3, N3, N4, P3, P4	NC	Not Used. Leave unconnected.
L4	P1/PARP	CMOS/LVDS Parity Bit.
L5	D31/D15P	CMOS/LVDS Data Input.
L6	D27/D13P	CMOS/LVDS Data Input.
L7	D23/D11P	CMOS/LVDS Data Input.
L8	D19/D9P	CMOS/LVDS Data Input.
L9	D15/D7P	CMOS/LVDS Data Input.
L10	D11/D5P	CMOS/LVDS Data Input.
L11	D7/D3P	CMOS/LVDS Data Input.
L12	D3/D1P	CMOS/LVDS Data Input.
L13	FSP	Positive LVDS Frame Sync (FSP) for Data Bus.
L14	CMOS_BUS	Active High Input. Configures data bus for CMOS inputs. Low input configures data bus to accept LVDS inputs.
M1	SCLK	Qualifying Clock for SPI.
M4	P0/PARN	CMOS/LVDS Parity Bit.
M5	D30/D15N	CMOS/LVDS Data Input.
M6	D26/D13N	CMOS/LVDS Data Input.
M7	D22/D11N	CMOS/LVDS Data Input.
M8	D18/D9N	CMOS/LVDS Data Input.
M9	D14/D7N	CMOS/LVDS Data Input.
M10	D10/D5N	CMOS/LVDS Data Input.
M11	D6/D3N	CMOS/LVDS Data Input.
M12	D2/D1N	CMOS/LVDS Data Input.
M13	FSN	Negative LVDS Frame Sync (FSN) for Data Bus.

Pin No.	Mnemonic	Description
M14	CMOS_CTRL	Active High Input. Enables CMOS_DCO and CMOS_FS signals and disables DCOP/DCON and FSP/FSN signals. Low input disables CMOS_DCO and CMOS_FS signals and enables DCOP/DCON and FSP/FSN signals.
N1	SDO	Serial Data Output for SPI.
N2	RESET	Active High Input. Resets the AD9789.
N5	D29/D14P	CMOS/LVDS Data Input.
N6	D25/D12P	CMOS/LVDS Data Input.
N7	D21/D10P	CMOS/LVDS Data Input.
N8	D17/D8P	CMOS/LVDS Data Input.
N9	D13/D6P	CMOS/LVDS Data Input.
N10	D9/D4P	CMOS/LVDS Data Input.
N11	D5/D2P	CMOS/LVDS Data Input.
N12	D1/D0P	CMOS/LVDS Data Input.
N13	DCOP	Positive LVDS Data Clock Output (DCOP) for Data Bus.
N14	CMOS_FS	CMOS Frame Sync for Data Bus.
P1	SDIO	Serial Data Input/Output for SPI.
P2	IRQ	Active Low, Open-Drain Interrupt Request Output. Pull up to DVDD33 with a 10 k $\Omega$ resistor.
P5	D28/D14N	CMOS/LVDS Data Input.
P6	D24/D12N	CMOS/LVDS Data Input.
P7	D20/D10N	CMOS/LVDS Data Input.
P8	D16/D8N	CMOS/LVDS Data Input.
P9	D12/D6N	CMOS/LVDS Data Input.
P10	D8/D4N	CMOS/LVDS Data Input.
P11	D4/D2N	CMOS/LVDS Data Input.
P12	D0/D0N	CMOS/LVDS Data Input.
P13	DCON	Negative LVDS Data Clock Output (DCON) for Data Bus.
P14	CMOS_DCO	CMOS Data Clock Output for Data Bus.

# TYPICAL PERFORMANCE CHARACTERISTICS

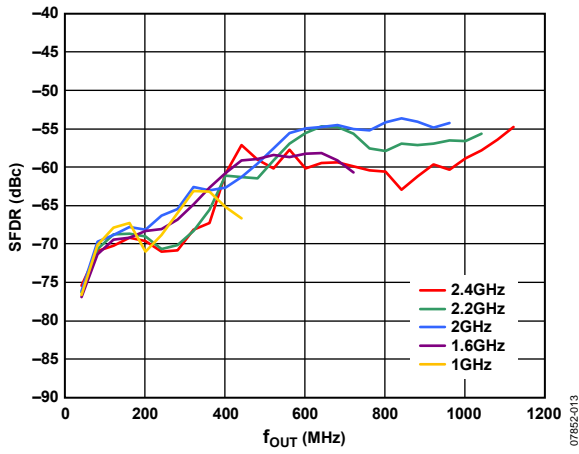

Figure 8. SFDR vs.  $f_{OUT}$  over  $f_{DAC}$ , Full-Scale Current = 20 mA, Digital Scale = 0 dBFS, Temperature = 25°C

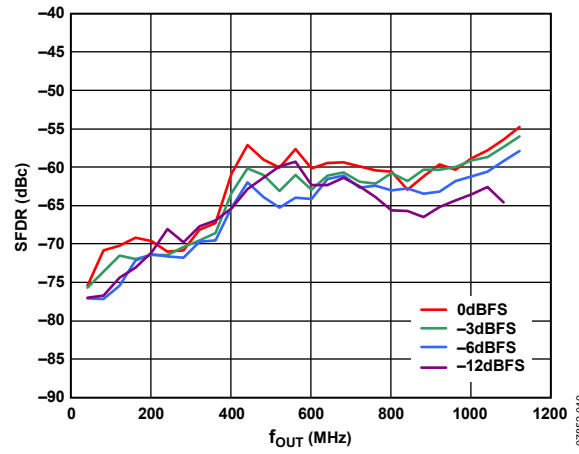

Figure 11. SFDR vs.  $f_{OUT}$  over Digital Full Scale,  $f_{DAC}$  = 2.4 GHz, Full-Scale Current = 20 mA, Temperature = 25°C

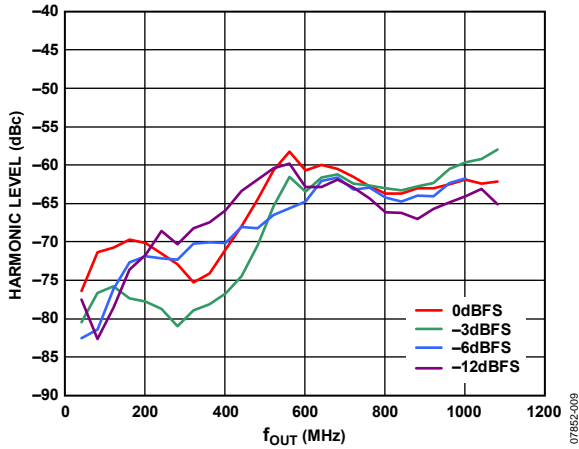

Figure 9. Second-Order Harmonic vs.  $f_{OUT}$  over Digital Full Scale,  $f_{DAC}$  = 2.4 GHz, Full-Scale Current = 20 mA, Temperature = 25°C

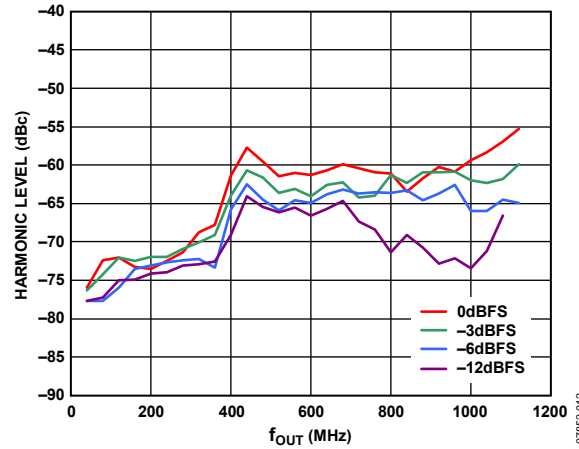

Figure 12. Third-Order Harmonic vs.  $f_{OUT}$  over Digital Full Scale,  $f_{DAC}$  = 2.4 GHz, Full-Scale Current = 20 mA, Temperature = 25°C

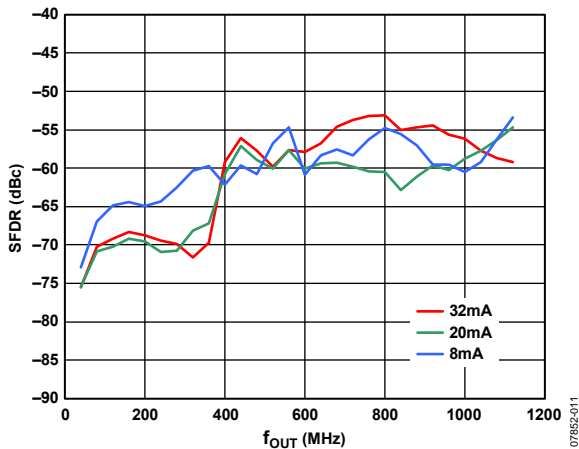

Figure 10. SFDR vs.  $f_{OUT}$  over Full-Scale Current,  $f_{DAC}$  = 2.4 GHz, Digital Scale = 0 dBFS, Temperature = 25°C

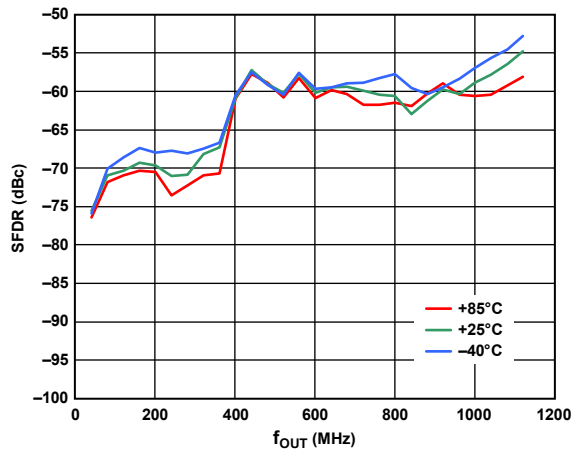

Figure 13. SFDR vs.  $f_{OUT}$  over Temperature,  $f_{DAC}$  = 2.4 GHz, Full-Scale Current = 20 mA, Digital Scale = 0 dBFS

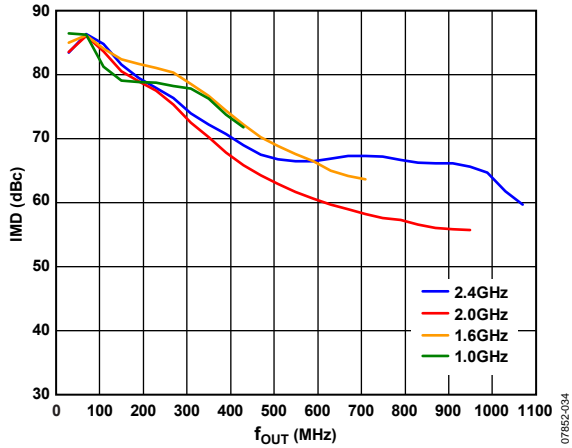

Figure 14. Third-Order IMD vs.  $f_{OUT}$  over  $f_{DAC}$ , Full-Scale Current = 20 mA, Digital Scale = 0 dBFS, Temperature = 25°C

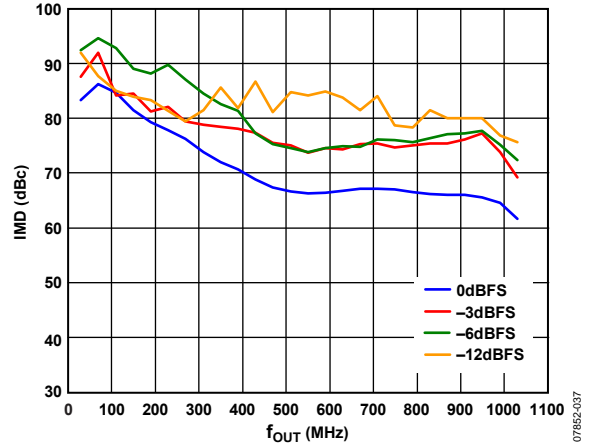

Figure 17. Third-Order IMD vs.  $f_{OUT}$  over Digital Full Scale,  $f_{DAC}$  = 2.4 GHz, Full-Scale Current = 20 mA, Temperature = 25°C

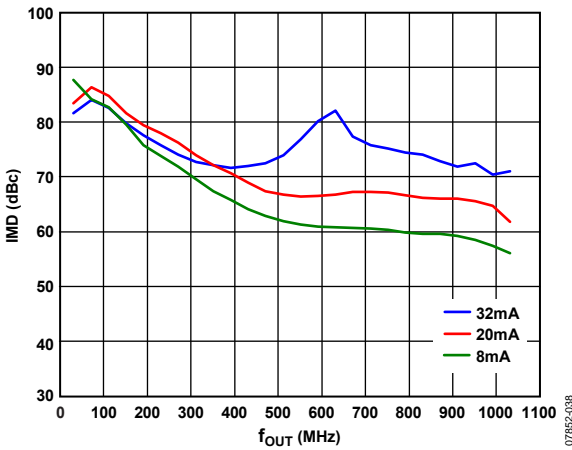

Figure 15. Third-Order IMD vs.  $f_{OUT}$  over Full-Scale Current,  $f_{DAC}$  = 2.4 GHz, Digital Scale = 0 dBFS, Temperature = 25°C

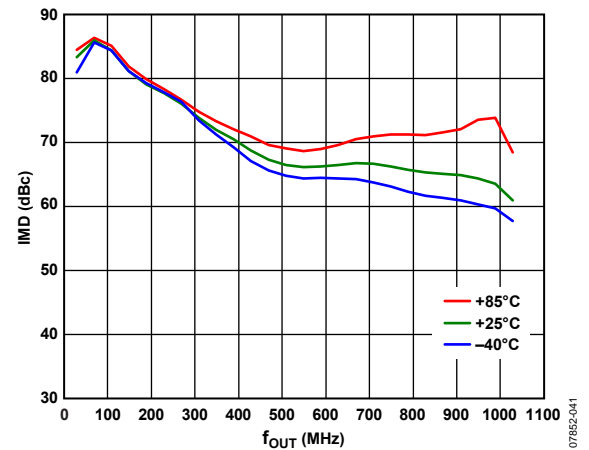

Figure 18. Third-Order IMD vs.  $f_{OUT}$  over Temperature,  $f_{DAC}$  = 2.4 GHz, Full-Scale Current = 20 mA, Digital Scale = 0 dBFS

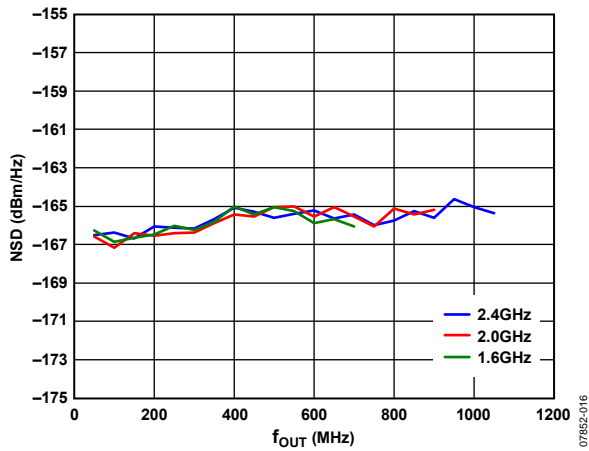

Figure 16. NSD vs.  $f_{OUT}$  over  $f_{DAC}$ , 1-Channel QAM, Full-Scale Current = 20 mA

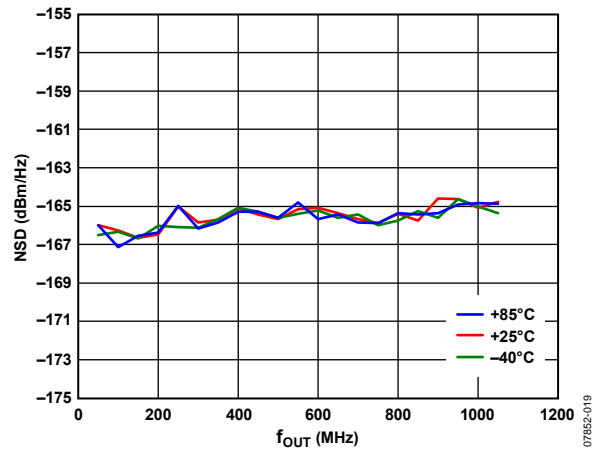

Figure 19. NSD vs.  $f_{OUT}$  over Temperature, 1-Channel QAM,  $f_{DAC}$  = 2.4 GHz, Full-Scale Current = 20 mA

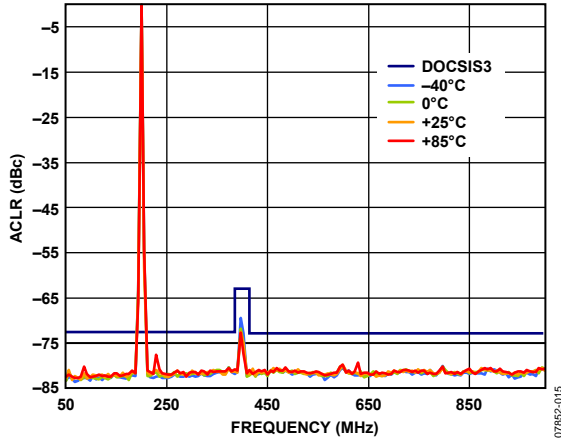

Figure 20. ACLR Performance over Temperature, 1-Channel QAM,  $f_{DAC} = 2.3$  GHz, Full-Scale Current = 20 mA,  $f_{OUT} = 200$  MHz, Sum Scale = 48 (DOCSIS SPEC Is -73 dBc; Harmonic Exception Is -63 dBc)

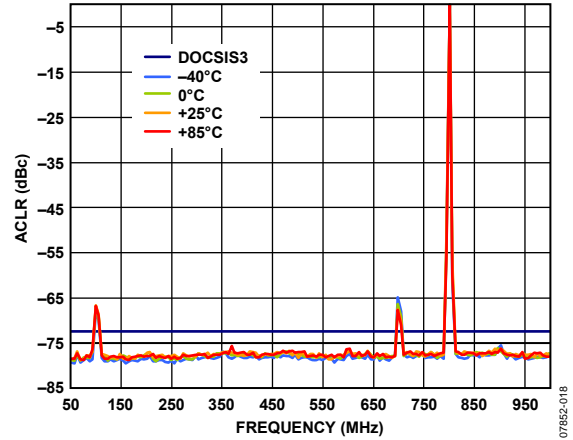

Figure 23. ACLR Performance over Temperature, 1-Channel QAM,  $f_{DAC} = 2.3$  GHz, Full-Scale Current = 20 mA,  $f_{OUT} = 800$  MHz, Sum Scale = 48 (DOCSIS SPEC Is -73 dBc)

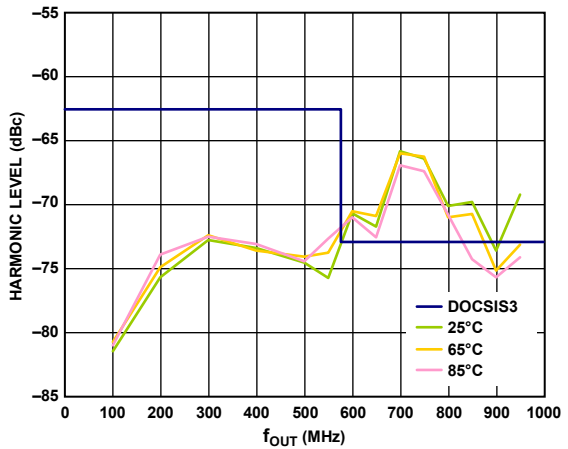

Figure 21. Second-Order Harmonic Performance vs.  $f_{OUT}$  over Temperature, 1-Channel QAM,  $f_{DAC} = 2.3$  GHz, Full-Scale Current = 20 mA, Sum Scale = 48 (DOCSIS SPEC Is -73 dBc; Harmonic Exception Is -63 dBc)

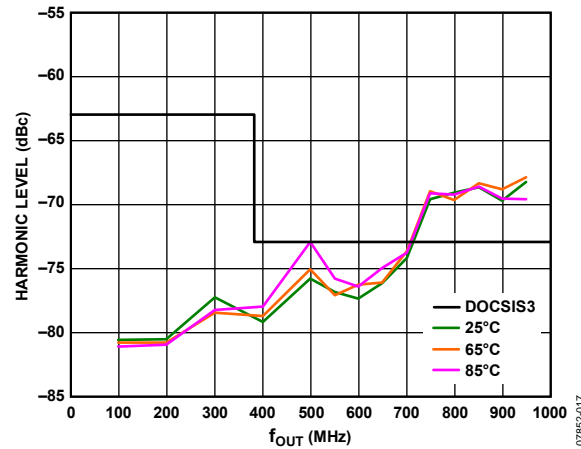

Figure 24. Third-Order Harmonic Performance vs.  $f_{OUT}$  over Temperature, 1-Channel QAM,  $f_{DAC} = 2.3$  GHz, Full-Scale Current = 20 mA, Sum Scale = 48 (DOCSIS SPEC Is -73 dBc; Harmonic Exception Is -63 dBc)

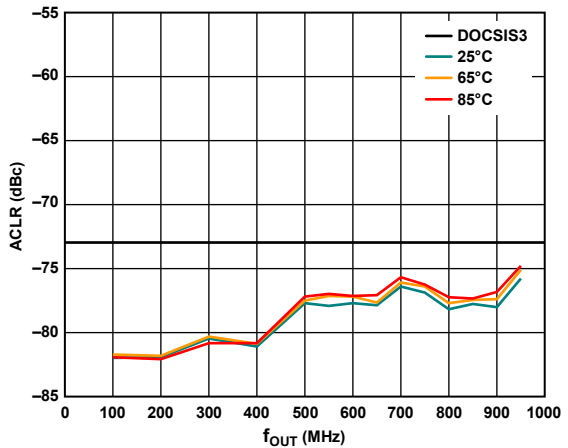

Figure 22. Noise Floor vs.  $f_{OUT}$  over Temperature (ACLR Measured Beyond 30 MHz), 1-Channel QAM,  $f_{DAC} = 2.3$  GHz, Full-Scale Current = 20 mA, Sum Scale = 48 (DOCSIS SPEC Is -73 dBc)

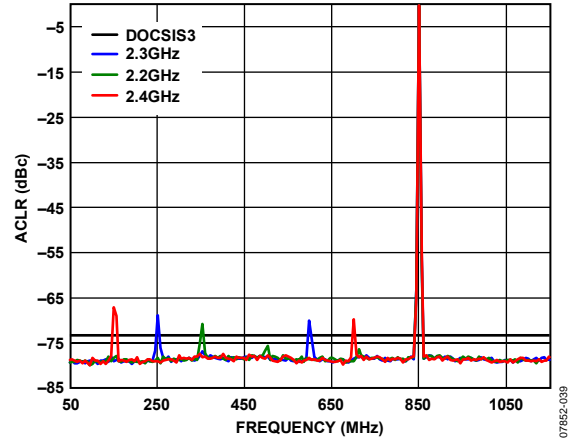

Figure 25. ACLR Performance over  $f_{DAC}$ , 1-Channel QAM,  $f_{OUT} = 850$  MHz, Full-Scale Current = 20 mA, Temperature = 25°C, Sum Scale = 48 (DOCSIS SPEC Is -73 dBc)

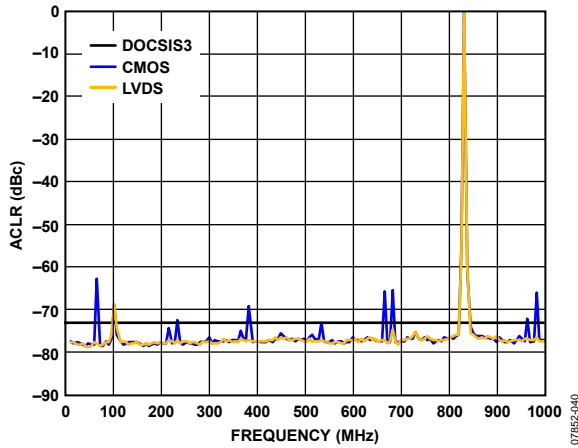

Figure 26. ACLR Performance for CMOS and LVDS Interfaces, 1-Channel QAM,  $f_{OUT} = 840$  MHz,  $f_{DAC} = 2.4$  GHz, Full-Scale Current = 20 mA, Sum Scale = 48 (DOCSIS SPEC Is -73 dBc)

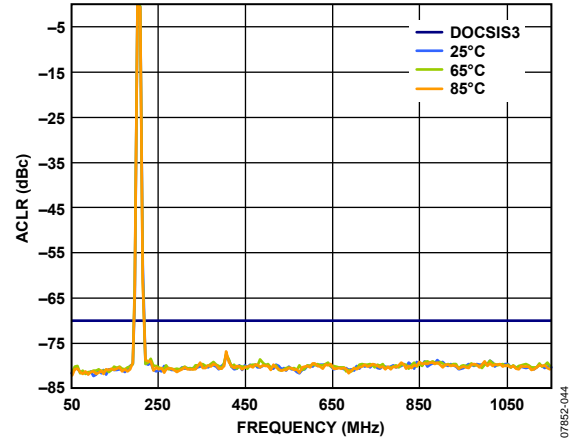

Figure 29. ACLR Performance over Temperature, 2-Channel QAM,  $f_{OUT} = 200$  MHz,  $f_{DAC} = 2.3$  GHz, Full-Scale Current = 25 mA, Sum Scale = 32 (DOCSIS SPEC Is -70 dBc; Harmonic Exception Is -63 dBc)

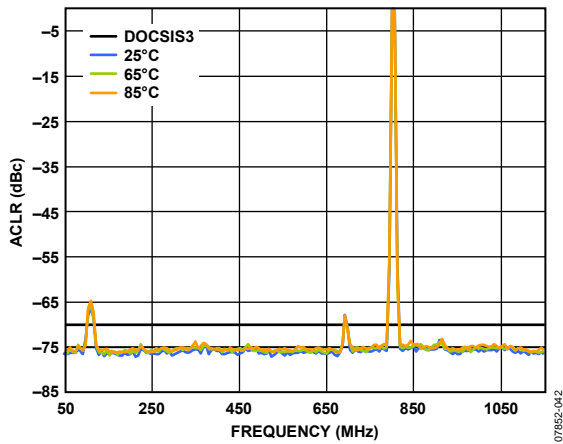

Figure 27. ACLR Performance over Temperature, 2-Channel QAM,  $f_{OUT} = 800$  MHz,  $f_{DAC} = 2.3$  GHz, Full-Scale Current = 25 mA, Sum Scale = 32 (DOCSIS SPEC Is -70 dBc)

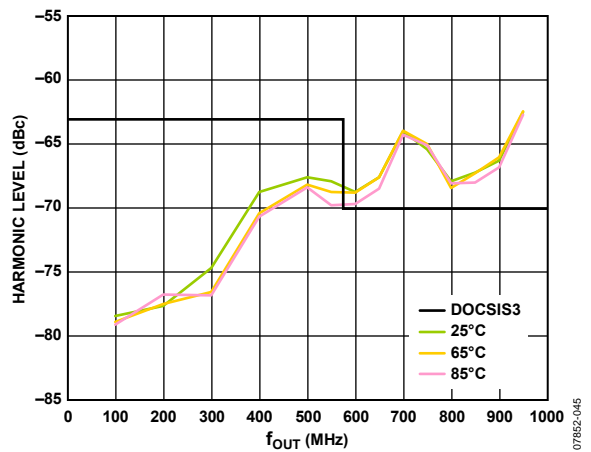

Figure 30. Second Harmonic Performance vs.  $f_{OUT}$  over Temperature, 2-Channel QAM,  $f_{DAC} = 2.3$  GHz, Full-Scale Current = 25 mA, Sum Scale = 32 (DOCSIS SPEC Is -70 dBc; Harmonic Exception Is -63 dBc)

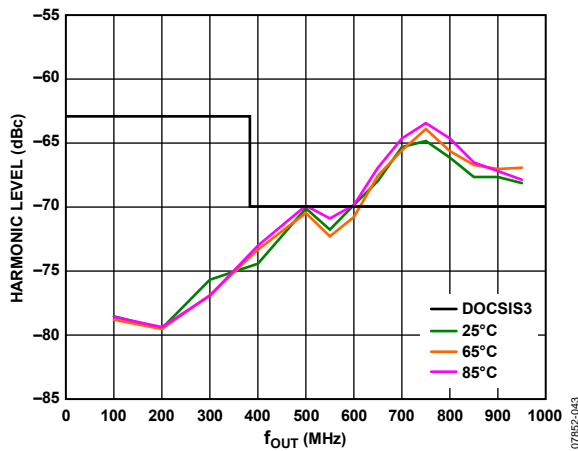

Figure 28. Third-Order Harmonic Performance vs.  $f_{OUT}$  over Temperature, 2-Channel QAM,  $f_{DAC} = 2.3$  GHz, Full-Scale Current = 25 mA, Sum Scale = 32 (DOCSIS SPEC Is -70 dBc; Harmonic Exception Is -63 dBc)

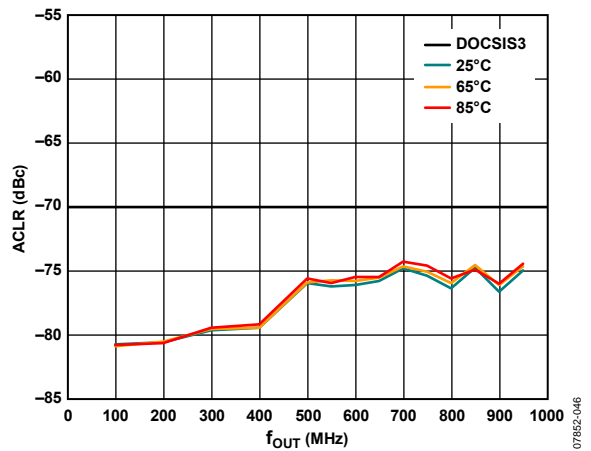

Figure 31. Noise Floor vs.  $f_{OUT}$  over Temperature (ACLR Measured Beyond 30 MHz), 2-Channel QAM,  $f_{DAC} = 2.3$  GHz, Full-Scale Current = 25 mA, Sum Scale = 32 (DOCSIS SPEC Is -70 dBc)

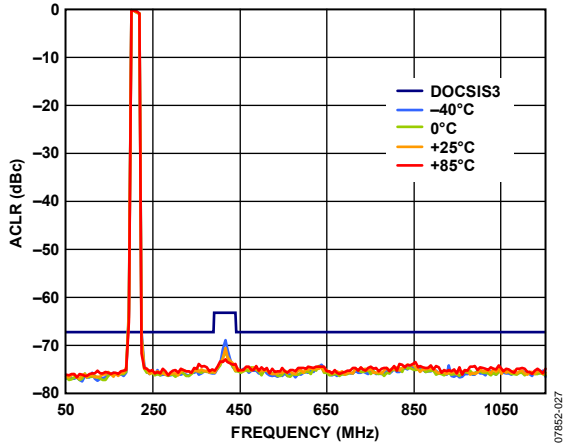

Figure 32. ACLR Performance over Temperature, 4-Channel QAM,  $f_{OUT} = 200$  MHz,  $f_{DAC} = 2.3$  GHz, Full-Scale Current = 25 mA, Sum Scale = 20 (DOCSIS SPEC Is -67 dBc; Harmonic Exception Is -63 dBc)

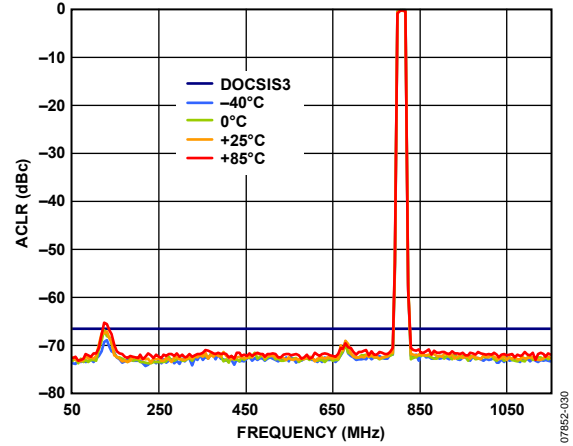

Figure 35. ACLR Performance over Temperature, 4-Channel QAM,  $f_{OUT} = 800$  MHz,  $f_{DAC} = 2.3$  GHz, Full-Scale Current = 25 mA, Sum Scale = 20 (DOCSIS SPEC Is -67 dBc)

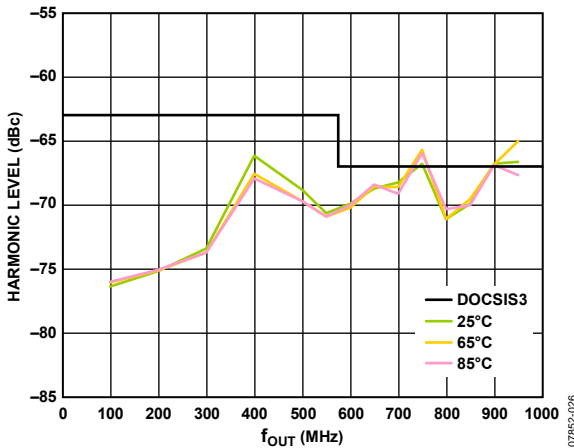

Figure 33. Second-Order Harmonic Performance vs.  $f_{OUT}$  over Temperature, 4-Channel QAM,  $f_{DAC} = 2.3$  GHz, Full-Scale Current = 25 mA, Sum Scale = 20 (DOCSIS SPEC Is -67 dBc; Harmonic Exception Is -63 dBc)

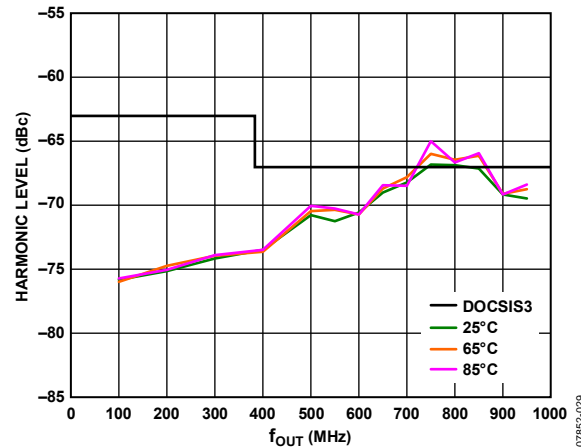

Figure 36. Third-Order Harmonic Performance vs.  $f_{OUT}$  over Temperature, 4-Channel QAM,  $f_{DAC} = 2.3$  GHz, Full-Scale Current = 25 mA, Sum Scale = 20 (DOCSIS SPEC Is -67 dBc; Harmonic Exception Is -63 dBc)

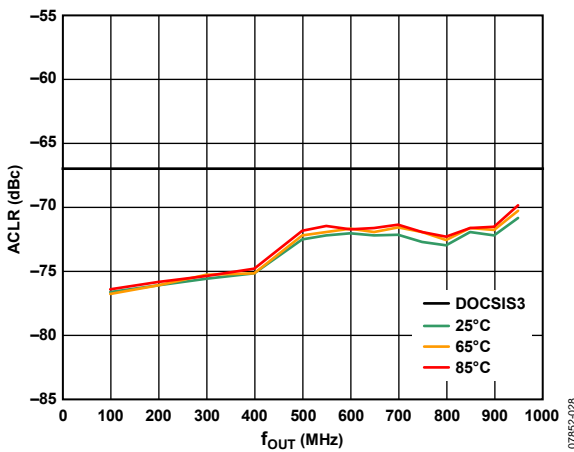

Figure 34. Noise Floor vs.  $f_{OUT}$  over Temperature (ACLR Measured Beyond 30 MHz), 4-Channel QAM,  $f_{DAC} = 2.3$  GHz, Full-Scale Current = 25 mA, Sum Scale = 20 (DOCSIS SPEC Is -67 dBc)

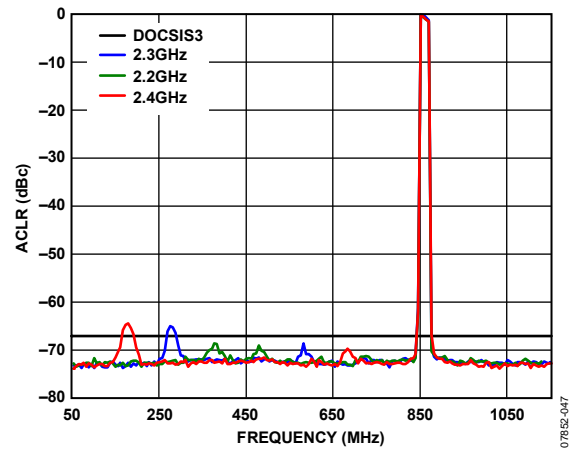

Figure 37. ACLR Performance over  $f_{DAC}$ , 4-Channel QAM,  $f_{OUT} = 850$  MHz, Full-Scale Current = 25 mA, Temperature = 25°C, Sum Scale = 20 (DOCSIS SPEC Is -67 dBc)



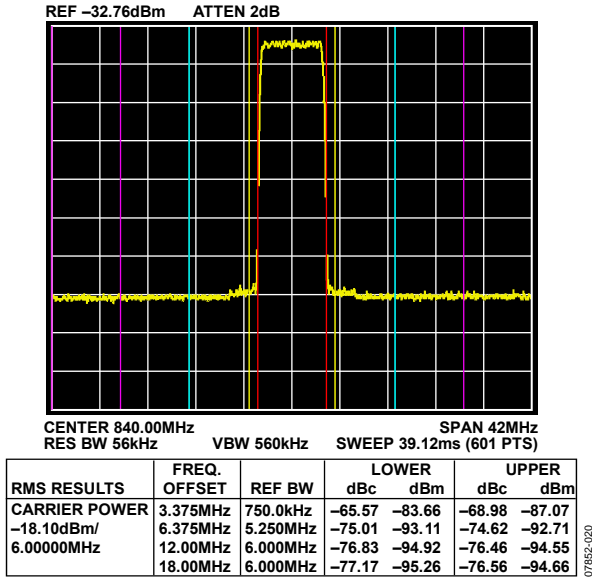

Figure 38. 1-Channel QAM ACLR,  $f_{OUT} = 840$  MHz, Temperature = 25°C, Sum Scale = 48, Full-Scale Current = 20 mA, Span = 42 MHz

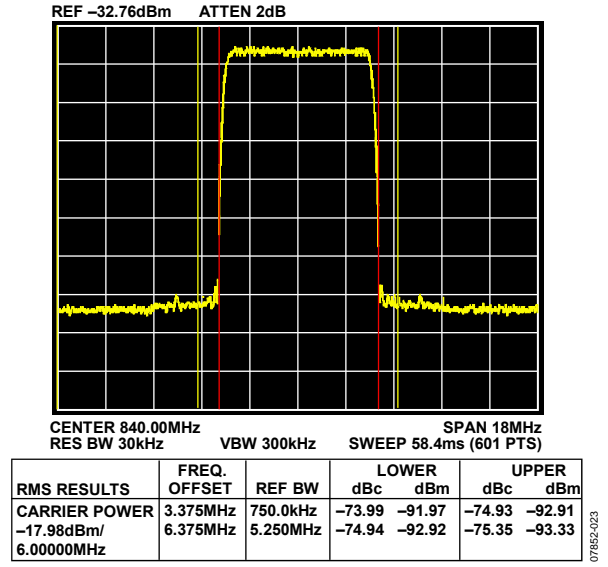

Figure 40. 1-Channel QAM ACLR,  $f_{OUT} = 840$  MHz, Temperature = 25°C, Sum Scale = 48, Full-Scale Current = 20 mA, Span = 18 MHz

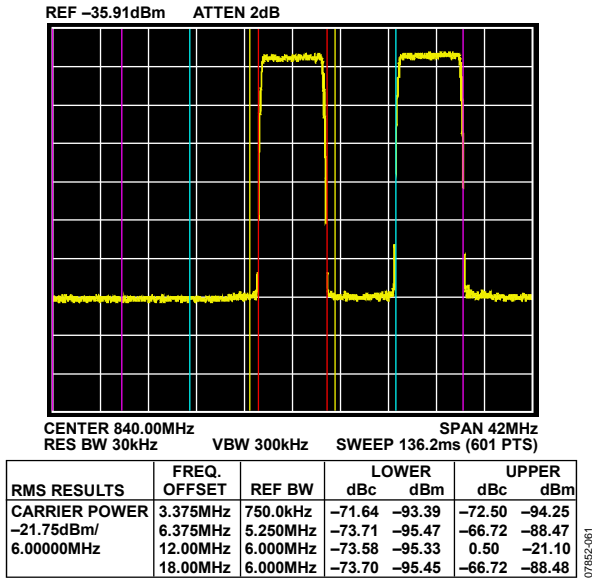

Figure 39. 2-Channel QAM ACLR,  $f_{OUT} = 840$  MHz, Sum Scale = 32, Full-Scale Current = 25 mA, Span = 42 MHz, Channel 1

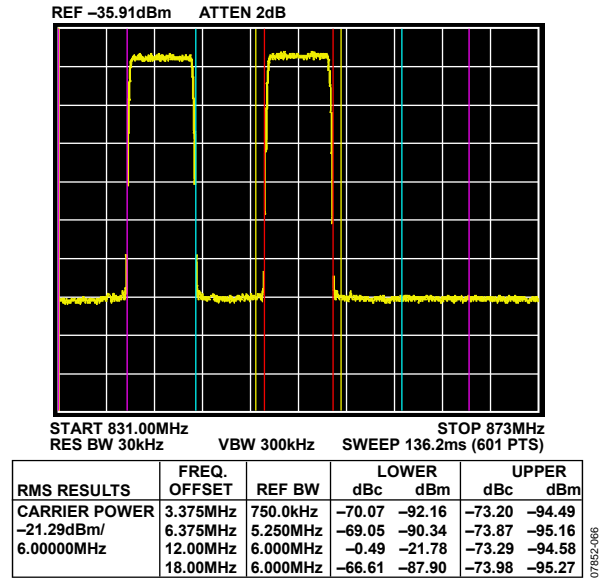
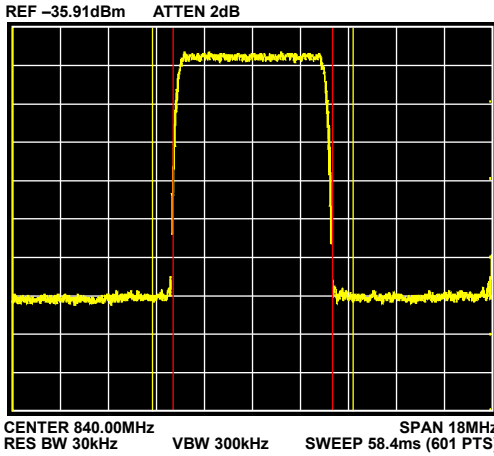
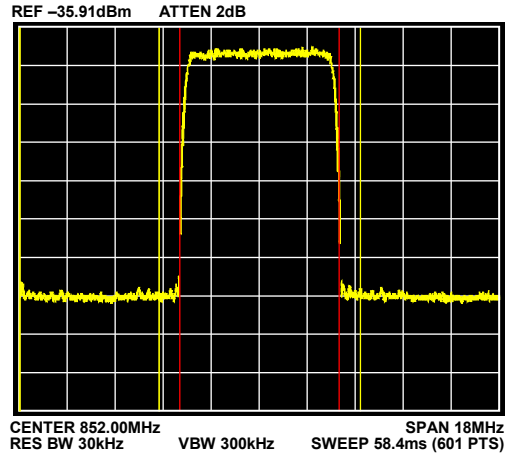

Figure 41. 2-Channel QAM ACLR,  $f_{OUT} = 840$  MHz, Sum Scale = 32, Full-Scale Current = 25 mA, Span = 42 MHz, Channel 2



RMS RESULTS	FREQ. OFFSET	REF BW	LOWER		UPPER	
			dBc	dBm	dBc	dBm
CARRIER POWER	3.375MHz	750.0kHz	-75.37	-96.93	-75.56	-97.11
-21.56dBm/ 6.00000MHz	6.375MHz	5.250MHz	-73.85	-95.41	-72.54	-94.10

Figure 42. 2-Channel QAM ACLR,  $f_{OUT} = 840$  MHz, Sum Scale = 32, Full-Scale Current = 25 mA, Span = 18 MHz, Channel 1



RMS RESULTS	FREQ. OFFSET	REF BW	LOWER		UPPER	
			dBc	dBm	dBc	dBm
CARRIER POWER	3.375MHz	750.0kHz	-75.51	-96.54	-75.17	-96.20
-21.03dBm/ 6.00000MHz	6.375MHz	5.250MHz	-72.55	-93.58	-73.90	-94.93

Figure 44. 2-Channel QAM ACLR,  $f_{OUT} = 840$  MHz, Sum Scale = 32, Full-Scale Current = 25 mA, Span = 18 MHz, Channel 2

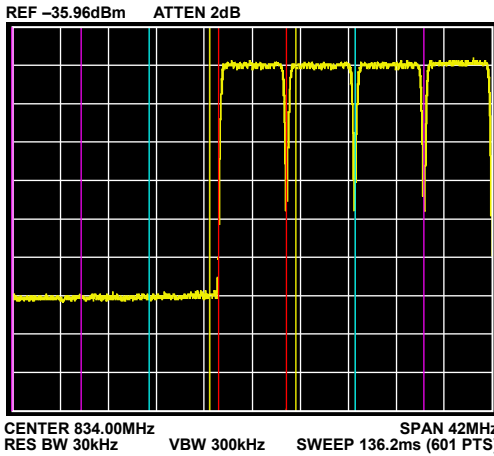

RMS RESULTS	FREQ. OFFSET	REF BW	LOWER		UPPER	
			dBc	dBm	dBc	dBm
CARRIER POWER	3.375MHz	750.0kHz	-70.33	-93.96	-11.07	-34.70
-23.63dBm/ 6.00000MHz	6.375MHz	5.250MHz	-69.04	-92.67	-0.49	-24.12
	12.00MHz	6.000MHz	-70.38	-94.01	0.00	-23.63
	18.00MHz	6.000MHz	-71.02	-94.65	0.43	-23.20

Figure 43. 4-Channel QAM ACLR,  $f_{OUT} = 840$  MHz, Temperature = 25°C, Sum Scale = 20, Full-Scale Current = 25 mA, Span = 42 MHz, Channel 1

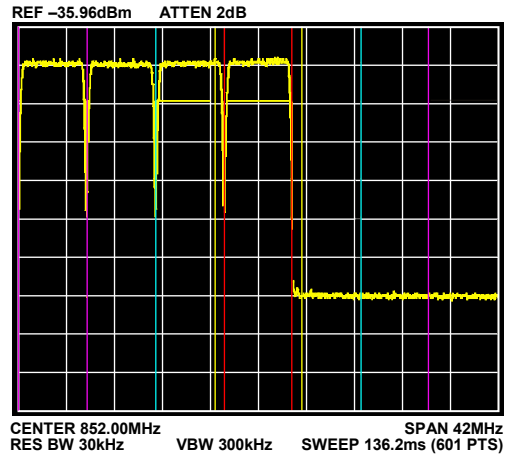

RMS RESULTS	FREQ. OFFSET	REF BW	LOWER		UPPER	
			dBc	dBm	dBc	dBm
CARRIER POWER	3.375MHz	750.0kHz	-11.10	-34.32	-72.19	-95.42
-23.23dBm/ 6.00000MHz	6.375MHz	5.250MHz	-0.75	-23.98	-68.97	-92.20
	12.00MHz	6.000MHz	-0.59	-23.81	-70.32	-93.55
	18.00MHz	6.000MHz	-0.35	-23.58	-70.70	-93.93

Figure 45. 4-Channel QAM ACLR,  $f_{OUT} = 840$  MHz, Temperature = 25°C, Sum Scale = 20, Full-Scale Current = 25 mA, Span = 42 MHz, Channel 4

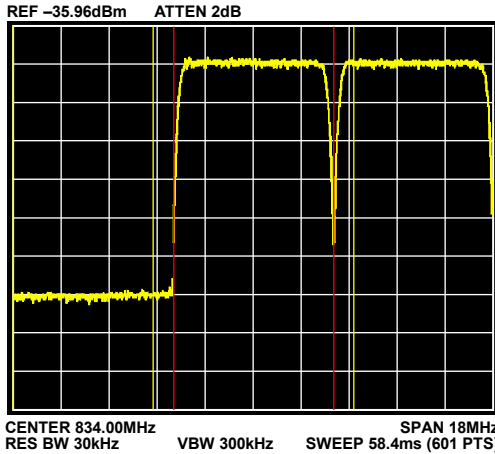

Figure 46. 4-Channel QAM ACLR,  $f_{OUT} = 840$  MHz, Temperature = 25°C, Sum Scale = 20, Full-Scale Current = 25 mA, Span = 18 MHz, Channel 1

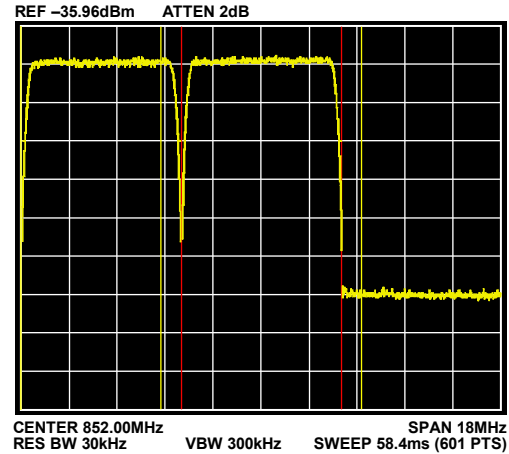

Figure 49. 4-Channel QAM ACLR,  $f_{OUT} = 840$  MHz, Temperature = 25°C, Sum Scale = 20, Full-Scale Current = 25 mA, Span = 18 MHz, Channel 4

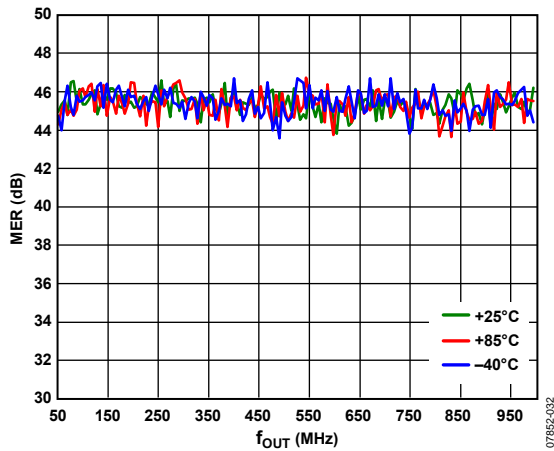

Figure 47. Modulation Error Ratio, Equalized, 1-Channel 256-QAM,  $f_{DAC} = 2.29376$  GHz, Full-Scale Current = 20 mA, Sum Scale = 48 (Equalization Filter from Demodulation Toolbox on Spectrum Analyzer Used)

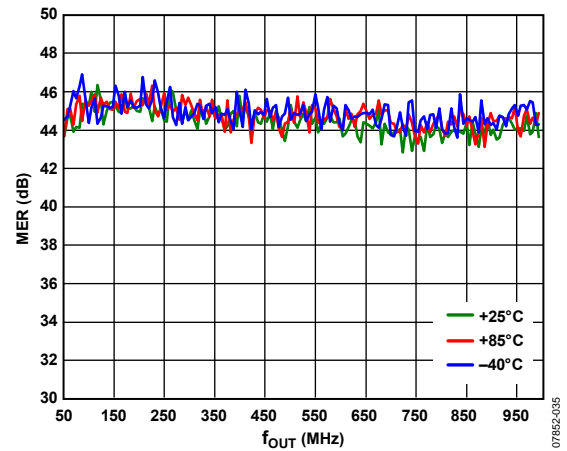

Figure 50. Modulation Error Ratio, Equalized, 4-Channel 256-QAM,  $f_{DAC} = 2.29376$  GHz, Full-Scale Current = 25 mA, Sum Scale = 20 (Equalization Filter from Demodulation Toolbox on Spectrum Analyzer Used)

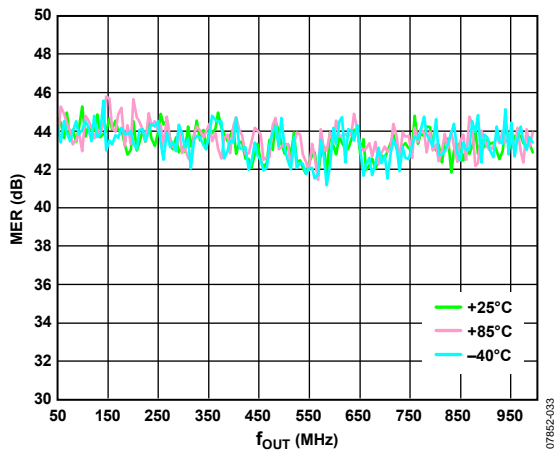

Figure 48. Modulation Error Ratio, Unequalized, 1-Channel 256-QAM,  $f_{DAC} = 2.29376$  GHz, Full-Scale Current = 20 mA, Sum Scale = 48

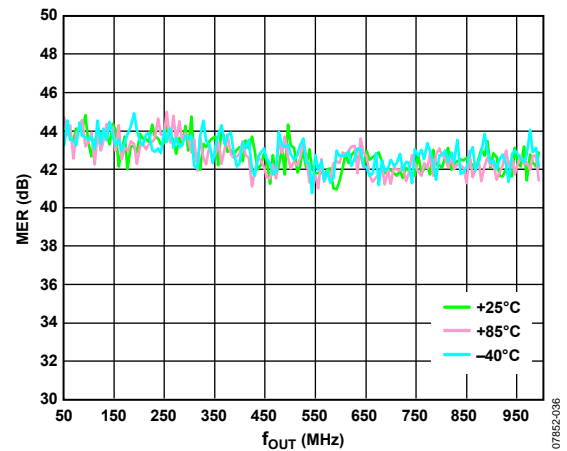

Figure 51. Modulation Error Ratio, Unequalized, 4-Channel 256-QAM,  $f_{DAC} = 2.29376$  GHz, Full-Scale Current = 25 mA, Sum Scale = 20

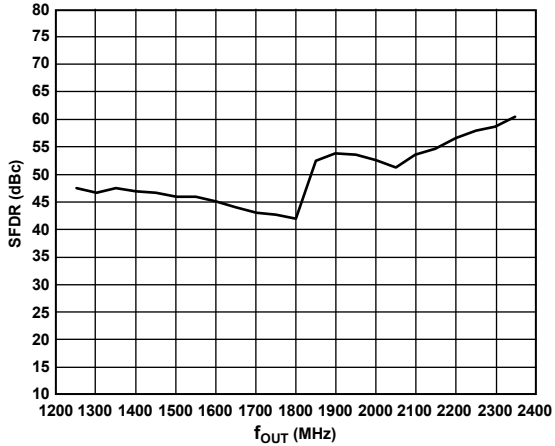

Figure 52. SFDR vs.  $f_{OUT}$  in Mix Mode,  $f_{DAC} = 2.4$  GHz, Full-Scale Current = 20 mA (Second Nyquist Zone Performance)

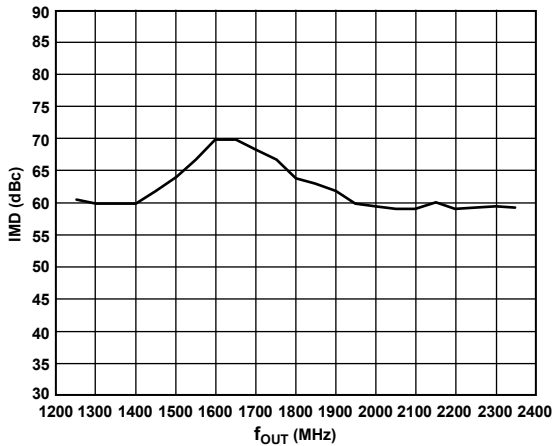

Figure 53. IMD vs.  $f_{OUT}$  in Mix Mode,  $f_{DAC} = 2.4$  GHz, Full-Scale Current = 20 mA (Second Nyquist Zone Performance)

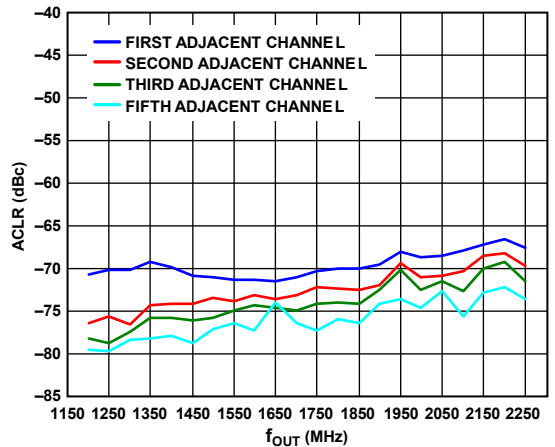
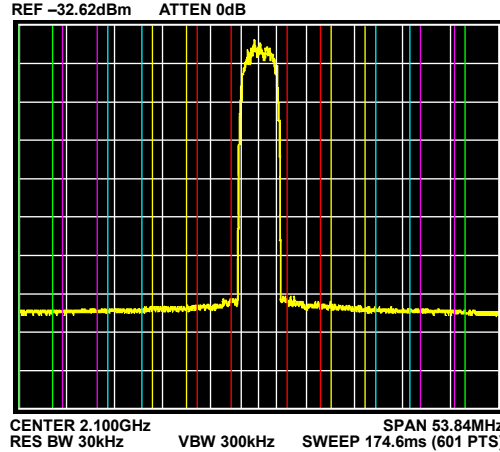
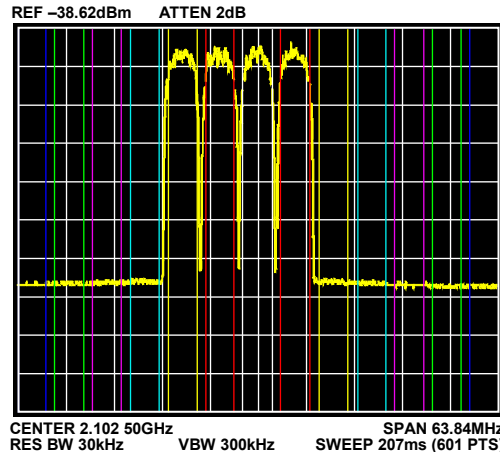

Figure 54. ACLR vs.  $f_{OUT}$  in Mix Mode with One-Carrier WCDMA,  $f_{DAC} = 2304$  MHz, Full-Scale Current = 20 mA (Second Nyquist Zone Performance)



RMS RESULTS	FREQ. OFFSET	REF BW	LOWER		UPPER	
			dBc	dBm	dBc	dBm
CARRIER POWER -19.95dBm/ 3.84000MHz	5.000MHz	3.840MHz	-68.93	-88.88	-67.99	-87.94
	10.00MHz	3.840MHz	-71.31	-91.26	-70.42	-90.37
	15.00MHz	3.840MHz	-73.43	-93.37	-72.68	-92.63
	20.00MHz	3.840MHz	-75.12	-95.07	-74.89	-94.84
	25.00MHz	3.840MHz	-75.60	-95.55	-76.51	-96.46

Figure 55. One-Carrier WCDMA ACLR in Mix Mode,  $f_{OUT} = 2.1$  GHz,  $f_{DAC} = 2304$  MHz, Full-Scale Current = 20 mA



RMS RESULTS	FREQ. OFFSET	REF BW	LOWER		UPPER	
			dBc	dBm	dBc	dBm
CARRIER POWER -26.06dBm/ 3.84000MHz	5.000MHz	3.840MHz	-0.25	-26.31	-0.42	-26.47
	10.00MHz	3.840MHz	-0.42	-26.48	-63.50	-89.56
	15.00MHz	3.840MHz	-64.07	-90.13	-65.13	-91.18
	20.00MHz	3.840MHz	-65.36	-91.42	-66.97	-93.03
	25.00MHz	3.840MHz	-66.86	-92.92	-68.70	-94.76
	30.00MHz	3.840MHz	-67.83	-93.89	-68.64	-94.70

Figure 56. Four-Carrier WCDMA ACLR in Mix Mode,  $f_{OUT} = 2.1$  GHz,  $f_{DAC} = 2304$  MHz, Full-Scale Current = 20 mA

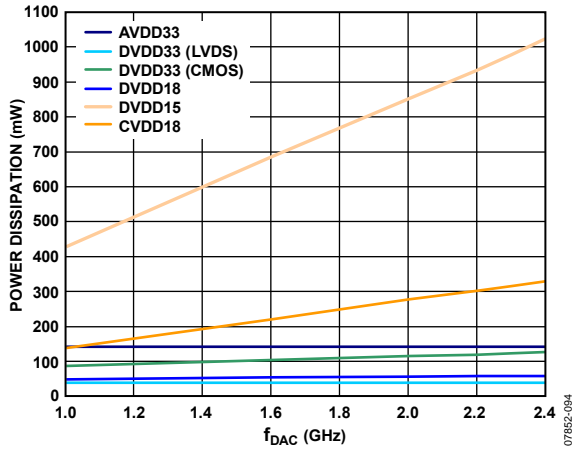

Figure 57. Power Dissipation by Supply vs.  $f_{DAC}$ , 4-Channel DOCSIS,  $f_{OUT} = 915$  MHz, Full-Scale Current = 25 mA (Datapath Configuration: QAM Encoder On, SRRC Filter On, Four 2× Interpolation Filters On)

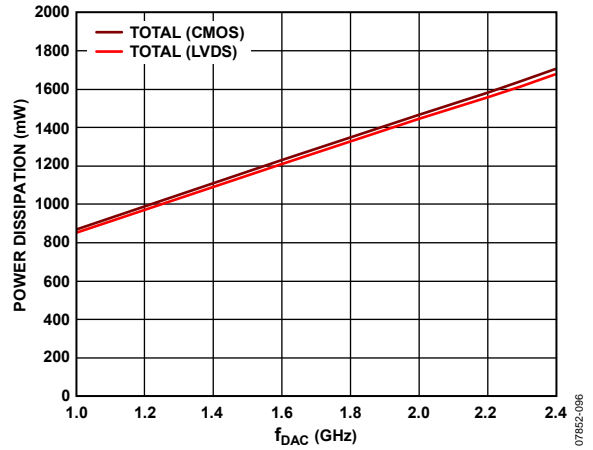

Figure 60. Total Power Dissipation vs.  $f_{DAC}$ , 4-Channel DOCSIS,  $f_{OUT} = 915$  MHz, Full-Scale Current = 25 mA (Datapath Configuration: QAM Encoder On, SRRC Filter On, Four 2× Interpolation Filters On)

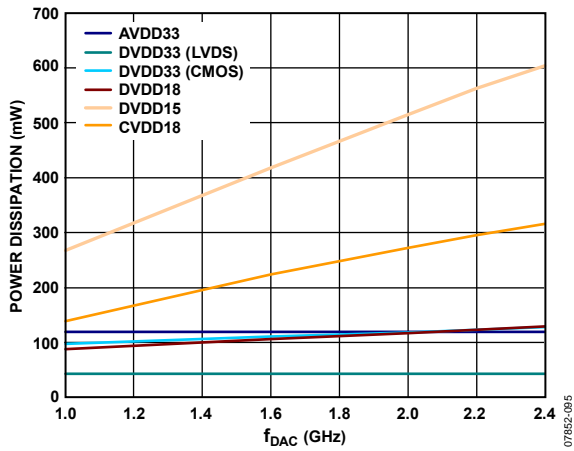

Figure 58. Power Dissipation by Supply vs.  $f_{DAC}$ , 16× Interpolation, One Channel Enabled,  $f_{OUT} = 70$  MHz, Full-Scale Current = 20 mA

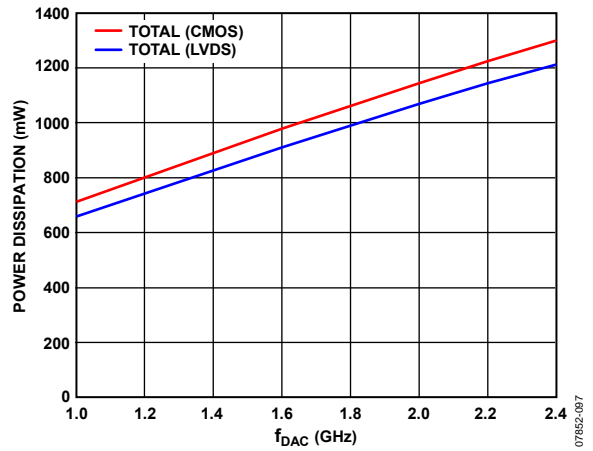

Figure 61. Total Power Dissipation vs.  $f_{DAC}$ , 16× Interpolation, One Channel Enabled,  $f_{OUT} = 70$  MHz, Full-Scale Current = 20 mA

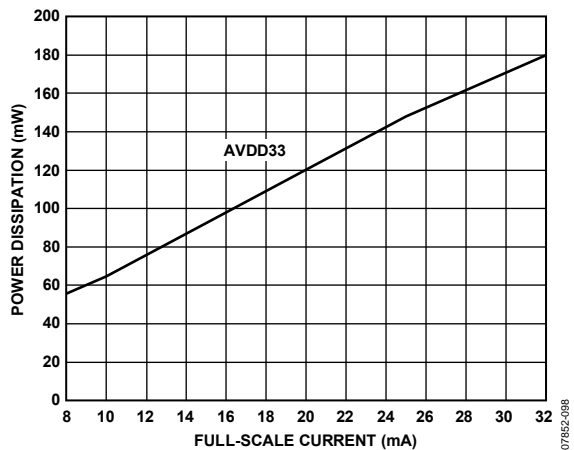

Figure 59. AVDD33 Power Dissipation vs. Full-Scale Current

## TERMINOLOGY

### Monotonicity

A DAC is monotonic if the output either increases or remains constant as the digital input increases.

### Offset Error

Offset error is the deviation of the output current from the ideal of 0. For IOUTP, 0 mA output is expected when all inputs are set to 0. For IOUTN, 0 mA output is expected when all inputs are set to 1.

### Gain Error

Gain error is the difference between the actual and ideal output span. The actual span is determined by the output when all inputs are set to 1s minus the output when all inputs are set to 0s.

### Temperature Drift

Temperature drift is specified as the maximum change from the ambient (25°C) value to the value at either  $T_{MIN}$  or  $T_{MAX}$ . For offset, gain, and reference drift, the drift is reported in ppm per °C.

### Power Supply Rejection (PSR)

PSR is the maximum change in the full-scale output as the supplies are varied from nominal to minimum and maximum specified voltages.

### Output Compliance Range

The output compliance range is the range of allowable voltage at the output of a current output DAC. Operation beyond the maximum compliance limits may cause either output stage saturation or breakdown, resulting in nonlinear performance.

### Spurious-Free Dynamic Range (SFDR)

SFDR is the difference, in dB, between the peak amplitude of the output signal and the peak spurious signal over the specified bandwidth.

### Noise Spectral Density (NSD)

NSD is the converter noise power per unit of bandwidth. NSD is usually specified in dBm/Hz in the presence of a 0 dBm full-scale signal.

### Adjacent Channel Leakage Ratio (ACLR)

The adjacent channel leakage (power) ratio is the ratio, in dBc, between the measured power within a channel relative to its adjacent channels.

### Modulation Error Ratio (MER)

Modulated signals create a discrete set of output values referred to as a constellation. Each symbol creates an output signal corresponding to one point on the constellation. MER is a measure of the discrepancy between the average output symbol magnitude and the rms error magnitude of the individual symbol.

### Intermodulation Distortion (IMD)

IMD is the result of two or more signals at different frequencies mixing together. Many products are created according to the formula  $af_1 \pm bf_2$ , where a and b are integer values.

## SERIAL CONTROL PORT

The AD9789 serial control port is a flexible, synchronous serial communications port that allows an easy interface to many industry-standard microcontrollers and microprocessors. The AD9789 serial control port is compatible with most synchronous transfer formats, including both the Motorola SPI® and Intel® SSR protocols. The serial control port allows read/write access to all registers that configure the AD9789. Single- or multiple-byte transfers are supported, as well as MSB first or LSB first transfer formats. The AD9789 serial control port can be configured for a single bidirectional I/O pin (SDIO only) or for two unidirectional I/O pins (SDIO/SDO). By default, the AD9789 is in unidirectional long instruction mode (long instruction mode is the only instruction mode supported).

### SERIAL CONTROL PORT PIN DESCRIPTIONS

The SCLK (serial clock) pin is the serial shift clock. This pin is an input. SCLK is used to synchronize serial control port reads and writes. Write data bits are registered on the rising edge of this clock, and read data bits are registered on the falling edge. This pin is internally pulled down by a 30 kΩ resistor to ground.

SDIO (serial data input/output) is a dual-purpose pin that acts as an input only (unidirectional mode) or as both an input and an output (bidirectional mode). The AD9789 defaults to the unidirectional I/O mode (Register 0x00[7] = 0).

The SDO (serial data output) pin is used only in the unidirectional I/O mode as a separate output pin for reading back data.

$\overline{\text{CS}}$  (chip select bar) is an active low control that gates the read and write cycles. When  $\overline{\text{CS}}$  is high, SDO and SDIO are in a high impedance state. This pin is internally pulled up by a 30 kΩ resistor to DVDD33.

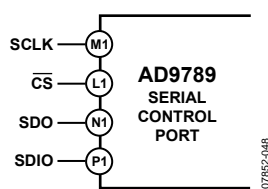

Figure 62. Serial Control Port

### GENERAL OPERATION OF SERIAL CONTROL PORT

A write or read operation to the AD9789 is initiated by pulling  $\overline{\text{CS}}$  low.  $\overline{\text{CS}}$  stall high is supported in modes where three or fewer bytes of data (plus the instruction data) are transferred (see Table 7). In these modes,  $\overline{\text{CS}}$  can temporarily return high on any byte boundary, allowing time for the system controller to process the next byte.  $\overline{\text{CS}}$  can go high on byte boundaries only and can go high during either part (instruction or data) of the transfer.

During  $\overline{\text{CS}}$  stall high mode, the serial control port state machine enters a wait state until all data is sent. If the system controller decides to abort the transfer before all of the data is sent, the state machine must be reset by either completing the remaining

transfers or by returning  $\overline{\text{CS}}$  low for at least one complete SCLK cycle (but less than eight SCLK cycles). Raising  $\overline{\text{CS}}$  on a nonbyte boundary terminates the serial transfer and flushes the buffer.

In streaming mode (see Table 7), any number of data bytes can be transferred in a continuous stream. The register address is automatically incremented or decremented (see the MSB/LSB First Transfers section).  $\overline{\text{CS}}$  must be raised at the end of the last byte to be transferred, thereby ending streaming mode.

### Communication Cycle—Instruction Plus Data

There are two parts to a communication cycle with the AD9789. In the first part, a 16-bit instruction word is written to the AD9789, coincident with the first 16 SCLK rising edges. The instruction word provides the AD9789 serial control port with information regarding the data transfer, which is the second part of the communication cycle. The instruction word defines whether the upcoming data transfer is a read or a write, the number of bytes in the data transfer, and the starting register address for the first byte of the data transfer.

### Write

If the instruction word is for a write operation, the second part of the communication cycle is the transfer of data into the serial control port buffer of the AD9789. Data bits are registered on the rising edge of SCLK.

The length of the transfer (one, two, or three bytes or streaming mode) is indicated by two bits (N1 and N0) in the instruction byte. When the transfer is one, two, or three bytes (but not streaming mode),  $\overline{\text{CS}}$  can be raised after each sequence of eight bits to stall the bus, except after the last byte, where it ends the cycle. When the bus is stalled, the serial transfer resumes when  $\overline{\text{CS}}$  is lowered. Raising  $\overline{\text{CS}}$  on a nonbyte boundary resets the serial control port. During a write, streaming mode does not skip reserved or blank registers; therefore, the user must know what bit pattern to write to the reserved registers to preserve proper operation of the part. It does not matter what data is written to blank registers.

Most writes to the control registers immediately reconfigure the device. However, Register 0x16 through Register 0x1D do not directly control device operation. They provide data to internal logic that must perform additional operations on the data before it is downloaded and the device configuration is changed. For any updates to Register 0x16 through Register 0x1D to take effect, the FREQNEW bit (Register 0x1E[7]) must be set to 1 (this bit is self-clearing). Any number of bytes of data can be changed before updating registers. Setting the FREQNEW bit simultaneously updates Register 0x16 through Register 0x1D.

In a similar fashion, any changes to Register 0x22 and Register 0x23 require PARMNEW (Register 0x24[7]) to be toggled from a low state to a high state before the new values take effect. Unlike the FREQNEW bit, PARMNEW is not self-clearing.

**Read**

If the instruction word is for a read operation, the next  $N \times 8$  SCLK cycles clock out the data from the address specified in the instruction word, where N is 1 to 3 as determined by Bits[N1:N0]. If  $N = 4$ , the read operation is in streaming mode, continuing until  $\overline{CS}$  is raised. Streaming mode does not skip over reserved or blank registers. The readback data is valid on the falling edge of SCLK.

The default mode of the AD9789 serial control port is the unidirectional mode. In unidirectional mode, the readback data appears on the SDO pin. It is also possible to set the AD9789 to bidirectional mode using the SDIO\_DIR bit (Register 0x00[7]). In bidirectional mode, both the sent data and the readback data appear on the SDIO pin.

A readback request reads the data that is in the serial control port buffer area or the data in the active registers (see Figure 63).

The AD9789 supports only the long instruction mode; therefore, Register 0x00[4:3] reads 11 (this register uses mirrored bits). Long instruction mode is the default at power-up or reset, and writing to these bits has no effect.

The AD9789 uses Register Address 0x00 to Register Address 0x55.

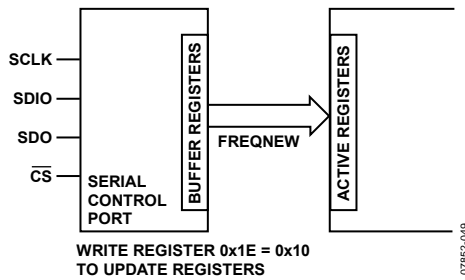

Figure 63. Relationship Between Serial Control Port Buffer Registers and Active Registers of the AD9789

**INSTRUCTION WORD (16 BITS)**

The MSB of the instruction word is  $R/\overline{W}$ , which indicates whether the instruction is a read or a write. The next two bits, N1 and N0, indicate the length of the transfer in bytes. The final 13 bits (Bits[A12:A0]) are the address at which to begin the read or write operation.

For a write, the instruction word is followed by the number of bytes of data indicated by Bits[N1:N0] (see Table 7).

**Table 7. Byte Transfer Count**

N1	N0	Bytes to Transfer
0	0	1
0	1	2
1	0	3
1	1	Streaming mode

Bits[A12:A0] select the address within the register map that is written to or read from during the data transfer portion of the communication cycle. Only Bits[A6:A0] are needed to cover the range of the 0x55 registers used by the AD9789. Bits[A12:A7] must always be 0. For multibyte transfers, this address is the starting byte address. In MSB first mode, subsequent bytes increment the address.

**MSB/LSB FIRST TRANSFERS**

The AD9789 instruction word and byte data can be MSB first or LSB first. Any data written to Register 0x00 must be mirrored, the upper four bits (Bits[7:4]) with the lower four bits (Bits [3:0]). This makes it irrelevant whether LSB first or MSB first is in effect. As an example of this mirroring, the default setting for Register 0x00[7:0] is 0x18, which mirrors Bit 4 and Bit 3. These bits set the long instruction mode (the default and the only mode supported). The default for the AD9789 is MSB first.

When LSB first is set by Register 0x00[1] and Register 0x00[6], it takes effect immediately. In multibyte transfers, subsequent bytes reflect any changes in the serial port configuration.

When MSB first mode is active, the instruction and data bytes must be written from MSB to LSB. Multibyte data transfers in MSB first format start with an instruction byte that includes the register address of the most significant data byte. Subsequent data bytes must follow in order from the high address to the low address. In MSB first mode, the serial control port internal address generator decrements for each data byte of the multibyte transfer cycle.

When LSB first mode is active, the instruction and data bytes must be written from LSB to MSB. Multibyte data transfers in LSB first format start with an instruction byte that includes the register address of the least significant data byte followed by multiple data bytes. The internal byte address generator of the serial control port increments for each byte of the multibyte transfer cycle.

The AD9789 serial control port register address decrements from the register address just written toward 0x00 for multibyte I/O operations if the MSB first mode is active (default). If the LSB first mode is active, the register address of the serial control port increments from the address just written toward 0x55 for multibyte I/O operations.

Streaming mode always terminates when it reaches Address 0x2F. Note that unused addresses are not skipped during multibyte I/O operations.

**Table 8. Streaming Mode (No Addresses Are Skipped)**

Write Mode	Address Direction	Stop Sequence
LSB First	Increment	0x02D, 0x02E, 0x02F, stop
MSB First	Decrement	0x001, 0x000, 0x02F, stop



Table 9. Serial Control Port, 16-Bit Instruction Word, MSB First

MSB														LSB	
I15	I14	I13	I12	I11	I10	I9	I8	I7	I6	I5	I4	I3	I2	I1	I0
R/ $\bar{W}$	N1	N0	A12	A11	A10	A9	A8	A7	A6	A5	A4	A3	A2	A1	A0

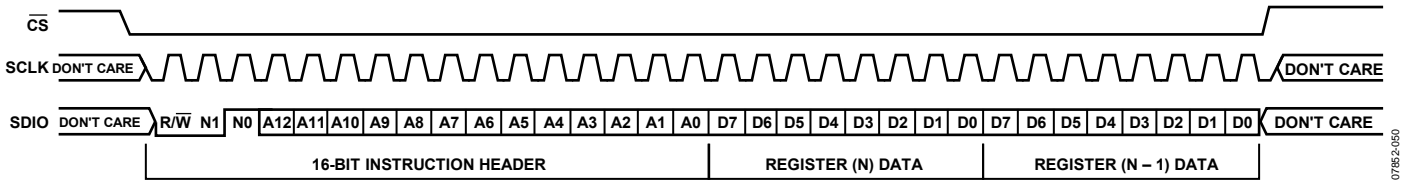

Figure 64. Serial Control Port Write—MSB First, 16-Bit Instruction, Two Bytes of Data

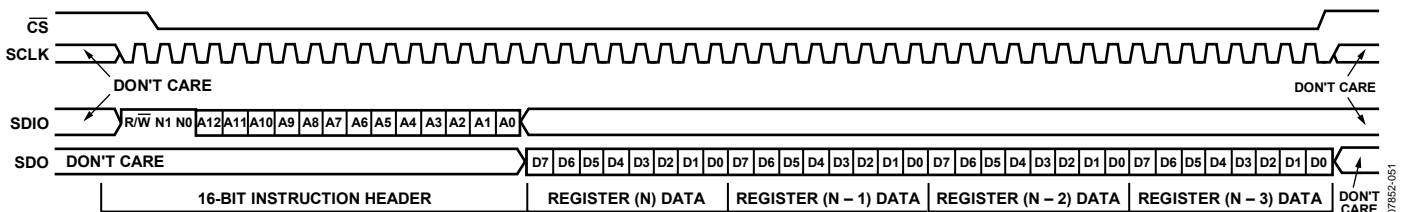

Figure 65. Serial Control Port Read—MSB First, 16-Bit Instruction, Four Bytes of Data

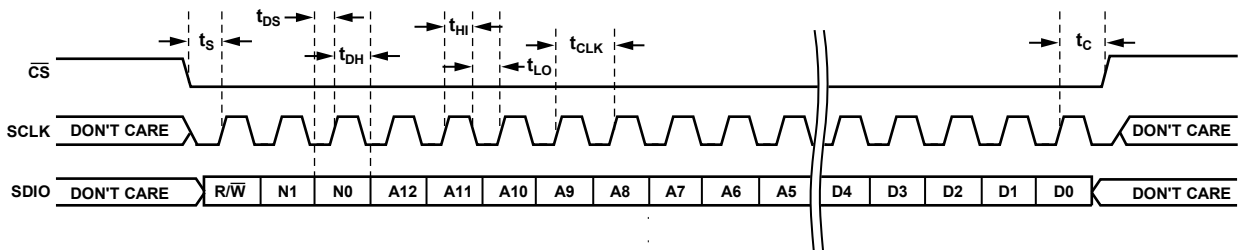

Figure 66. Serial Control Port Write—MSB First, 16-Bit Instruction, Timing Measurements

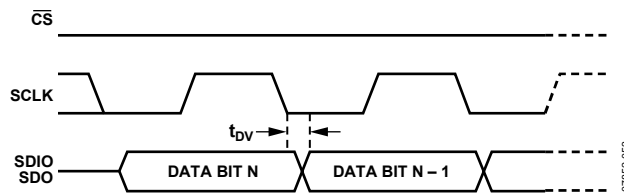

Figure 67. Timing Diagram for Serial Control Port Register Read

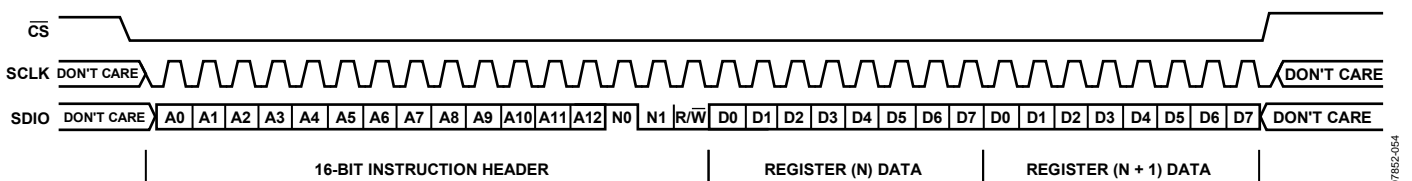

Figure 68. Serial Control Port Write—LSB First, 16-Bit Instruction, Two Bytes of Data

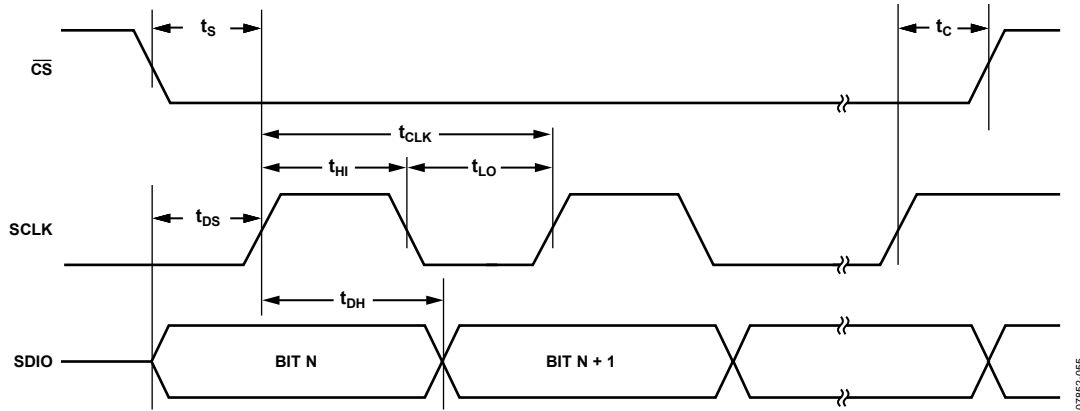

Figure 69. Serial Control Port Timing—Write

07852-065

Table 10. Serial Control Port Timing

Parameter	Description
$t_{DS}$	Setup time between data and rising edge of SCLK
$t_{DH}$	Hold time between data and rising edge of SCLK
$t_{CLK}$	Period of the clock
$t_s$	Setup time between $\overline{CS}$ falling edge and SCLK rising edge (start of communication cycle)
$t_c$	Setup time between SCLK rising edge and $\overline{CS}$ rising edge (end of communication cycle)
$t_{HI}$	Minimum period that SCLK should be in a logic high state
$t_{LO}$	Minimum period that SCLK should be in a logic low state
$t_{DV}$	SCLK to valid SDIO and SDO (see Figure 67)

## SPI REGISTER MAP

Do not write to the following registers unless instructed otherwise: Register 0x34, Register 0x35, Register 0x37, Register 0x3B, Register 0x3F, or Register 0x40 through Register 0x55.

**Table 11. Register Map**

Addr	Register Name	Bit 7	Bit 6	Bit 5	Bit 4	Bit 3	Bit 2	Bit 1	Bit 0	De- fault	
0x00	SPI control	SDIO_DIR	LSBFIRST	RESET	LNG_INST					0x18	
0x01	Saturation counter	SATCNT[7:0]								0x00	
0x02	Parity counter	PARCNT[7:0]								0x00	
0x03	Interrupt enable	PARERR	BISTDONE	PARMSET	PARMCLR	LOCKACQ	LOCKLOST	SATERR	Reserved	0x00	
0x04	Interrupt status/clear	PARERR	BISTDONE	PARMSET	PARMCLR	LOCKACQ	LOCKLOST	SATERR	Reserved	0x00	
0x05	Channel enable	Reserved				CHANEN[3:0]				0x00	
0x06	Bypass	QAM	SRRC	Reserved	INT[4:0]				0x00		
0x07	QAM/SRRC configuration	Reserved		ALPHA[1:0]		Reserved	MAPPING[2:0]			0x01	
0x08	Summing node scalar	SUMSCALE[7:0]								0x0D	
0x09	Input scalar	INSCALE[7:0]								0x20	
0x0A	NCO 0 frequency tuning word	FTW0[7:0]								0x00	
0x0B		FTW0[15:8]								0x00	
0x0C		FTW0[23:16]								0x00	
0x0D	NCO 1 frequency tuning word	FTW1[7:0]								0x00	
0x0E		FTW1[15:8]								0x00	
0x0F		FTW1[23:16]								0x00	
0x10	NCO 2 frequency tuning word	FTW2[7:0]								0x00	
0x11		FTW2[15:8]								0x00	
0x12		FTW2[23:16]								0x00	
0x13	NCO 3 frequency tuning word	FTW3[7:0]								0x00	
0x14		FTW3[15:8]								0x00	
0x15		FTW3[23:16]								0x00	
0x16	Rate converter denominator (Q)	Q[7:0]								0x00	
0x17		Q[15:8]								0x00	
0x18		Q[23:16]								0x80	
0x19	Rate converter numerator (P)	P[7:0]								0x00	
0x1A		P[15:8]								0x00	
0x1B		P[23:16]								0x80	
0x1C	Interpolating BPF center frequency	FC[7:0]								0x00	
0x1D		FC[15:8]								0x00	
0x1E	Frequency update	FREQNEW	Reserved							0x00	
0x1F	Hardware version	Reserved					VER[3:0]				0x03
0x20	Interface configuration	CMOS_BUS	CMOS_CTRL	Reserved	DCO_INV	IF_MODE	CHANPRI	PAR[1:0]		0xC8	
0x21	Data control	BIN	BUSWIDTH[1:0]		DATWIDTH	CMPLX	LTNCY[2:0]			0x61	
0x22	DCO frequency	Reserved	DCODIV[2:0]			ONES[3:0]			0x1F		
0x23	Internal clock phase adjust	DSCPHZ[3:0]				SNCPHZ[3:0]				0x85	
0x24	Parameter update	PARMNEW	Reserved							0x00	
0x25	Channel 0 gain	CHAN0GAIN[7:0]								0x80	
0x26	Channel 1 gain	CHAN1GAIN[7:0]								0x80	
0x27	Channel 2 gain	CHAN2GAIN[7:0]								0x80	
0x28	Channel 3 gain	CHAN3GAIN[7:0]								0x80	
0x29	Spectrum shaping	Reserved							SPEC_INV	0x00	

# AD9789

[查询"AD9789"供应商](#)

Addr	Register Name	Bit 7	Bit 6	Bit 5	Bit 4	Bit 3	Bit 2	Bit 1	Bit 0	De-fault	
0x2F	Mu Delay Control 1	SEARCH_TOL	SEARCH_ERR	TRACK_ERR	GUARDBAND[4:0]					0x0B	
0x30	Mu control duty cycle	Duty cycle correct enable	INC_DEC (Factory)	MANUAL_ADJ[5:0] (Factory test only)					0x40		
0x31	Clock Receiver 1	CLKN_CML[3:0]			Reserved					0xF0	
0x32	Clock Receiver 2	CLK_DIS	Reserved	PSIGN	CLKP_CML[3:0]			NSIGN	0x3F		
0x33	Mu Delay Control 2	MU_CLKDIS	SLOPE	MODE[1:0]		MUSAMP	GAIN[1:0]		MU_EN	0x42	
0x34	Reserved	Reserved								0x00	
0x35	Reserved	Reserved								0xCA	
0x36	DAC bias	PDBIAS	Reserved				MSEL[1:0]			0x03	
0x37	Reserved	Reserved								0x00	
0x38	DAC decoder	Reserved						DAC decoder mode			0x00
0x39	Mu Delay Control 3	MUDLY[0]	SEARCH_DIR[1:0]		MUPHZ[4:0]					0x40	
0x3A	Mu Delay Control 4	MUDLY[8:1]								0x00	
0x3B	Reserved	Reserved								0x00	
0x3C	Full-Scale Current 1	FSC[7:0]								0x00	
0x3D	Full-Scale Current 2	Reserved						FSC[9:8]			0x02
0x3E	Phase detector control	PHZ_PD	Reserved	CMP_BST	AUTO_CAL	PHZ_DET_BIAS[3:0]				0x18	
0x3F	Reserved	Reserved								0x00	
0x40	BIST control	CLKSHDN	INPUTSEL	Reserved	BENABLE	BMODE[3:0]				0x00	
0x41	BIST status	BDONE	BSTATUS[6:0]								0x00
0x42	BIST zero padding length	PADLEN[7:0]								0x00	
0x43		PADLEN[15:8]								0x00	
0x44	BIST vector length	VECTLEN[7:0]								0x00	
0x45		VECTLEN[15:8]								0x00	
0x46		VECTLEN[23:16]								0x00	
0x47	BIST clock adjust	BCLKDIV[3:0]				BCLKPHZ[3:0]				0x00	
0x48	Sign 0 control	S0ENABL	S0RDEN	S0PRNG	S0ZERO	S0NEG	S0FNLCH	S0SEL[1:0]		0x00	
0x49	Sign 0 clock adjust	S0CLKDIV[3:0]				S0CLKPHZ[3:0]				0x00	
0x4A	Sign 1 control	S1ENABL	S1RDEN	S1PRNG	S1ZERO	S1NEG	S1FNLCH	S1SEL[1:0]		0x00	
0x4B	Sign 1 clock adjust	S1CLKDIV[3:0]				S1CLKPHZ[3:0]				0x00	
0x4C	RegFnI0Freq	Final Rate/Offset Control 0 [7:0]								0x00	
0x4D	RegFnI1Freq	Final Rate/Offset Control 1 [7:0]								0x00	
0x50	BIST Signature 0	SGN0[7:0]								0x00	
0x51		SGN0[15:8]								0x00	
0x52		SGN0[23:16]								0x00	
0x53	BIST Signature 1	SGN1[7:0]								0x00	
0x54		SGN1[15:8]								0x00	
0x55		SGN1[23:16]								0x00	

**SPI REGISTER DESCRIPTIONS**
**Table 12. SPI Control Register (Address 0x00)**

Bit	Bit Name	Description
7	SDIO_DIR	This bit configures the SDIO pin as an input-only pin or as a bidirectional input/output pin. Both choices conform to the SPI standard. 0 = input only. 1 = bidirectional (input/output).
6	LSBFIRST	This bit configures the SPI interface for MSB first or LSB first mode. Both choices conform to the SPI standard. 0 = MSB first. 1 = LSB first.
5	RESET	When set to 1, this bit resets the part. After the part is reset, 0 is written to this bit on the next cycle. 0 = no reset. 1 = software reset.
4	LNG_INST	This bit sets the SPI to long instruction mode; 1 is the only valid value.
[3:0]		These bits should mirror Bits[7:4]. Bit 3 should mirror Bit 4, Bit 2 should mirror Bit 5, Bit 1 should mirror Bit 6, and Bit 0 should mirror Bit 7.

**Table 13. Saturation Counter Register (Address 0x01)**

Bit	Bit Name	Description
[7:0]	SATCNT[7:0]	This read-only register contains the saturation counter. This register reflects the number of samples at the output of the SUMSCALE gain block that overrange the datapath and are digitally clipped. The count is cleared by writing a 1 to Register 0x04, Bit 1.

**Table 14. Parity Counter Register (Address 0x02)**

Bit	Bit Name	Description
[7:0]	PARCNT[7:0]	This read-only register contains the input data parity error counter. The count is cleared by writing a 1 to Register 0x04, Bit 7.

**Table 15. Interrupt Enable Register (Address 0x03)**

Bit	Name	Description
7	PARERR	Setting this bit to 1 enables a PARERR flag to generate an interrupt request. Generating an interrupt request results in Interrupt Bit 7 being set in Register 0x04 and the IRQ pin going low.
6	BISTDONE	Setting this bit to 1 enables a BISTDONE flag to generate an interrupt request. Generating an interrupt request results in Interrupt Bit 6 being set in Register 0x04 and the IRQ pin going low.
5	PARMSET	Setting this bit to 1 enables a PARMSET flag to generate an interrupt request. Generating an interrupt request results in Interrupt Bit 5 being set in Register 0x04 and the IRQ pin going low.
4	PARMCLR	Setting this bit to 1 enables a PARMCLR flag to generate an interrupt request. Generating an interrupt request results in Interrupt Bit 4 being set in Register 0x04 and the IRQ pin going low.
3	LOCKACQ	Setting this bit to 1 enables a LOCKACQ flag to generate an interrupt request. Generating an interrupt request results in Interrupt Bit 3 being set in Register 0x04 and the IRQ pin going low.
2	LOCKLOST	Setting this bit to 1 enables a LOCKLOST flag to generate an interrupt request. Generating an interrupt request results in Interrupt Bit 2 being set in Register 0x04 and the IRQ pin going low.
1	SATERR	Setting this bit to 1 enables a SATERR (overflow into 16x interpolator) flag to generate an interrupt request. Generating an interrupt request results in Interrupt Bit 1 being set in Register 0x04 and the IRQ pin going low.
0	Reserved	Reserved.

Table 16. Interrupt Status/Clear Register (Address 0x04)

Bit	Name	Description
7	PARERR	If this bit is set to 1, one or more parity errors has occurred. Writing a 1 to this bit clears the interrupt.
6	BISTDONE	If this bit is set to 1, the BIST has reached the terminal state. Writing a 1 to this bit clears the interrupt.
5	PARMSET	If this bit is set to 1, the parameter update register (Address 0x24) has been updated. Writing a 1 to this bit clears the interrupt.
4	PARMCLR	If this bit is set to 1, the parameter update register (Address 0x24) has been cleared. Writing a 1 to this bit clears the interrupt.
3	LOCKACQ	If this bit is set to 1, proper data handoff between the digital engine and the DAC core is occurring.
2	LOCKLOST	If this bit is set to 1, proper data handoff between the digital engine and the DAC core has been lost. Writing a 1 to this bit clears the interrupt.
1	SATERR	If this bit is set to 1, one or more saturation errors (overflow into 16x interpolator) has occurred. Writing a 1 to this bit clears the interrupt.
0	Reserved	Reserved.

Table 17. Channel Enable Register (Address 0x05)

Bit	Bit Name	Description	
[7:4]	Reserved	Reserved.	
[3:0]	CHANEN[3:0]	A Logic 1 in any bit position enables the corresponding channel; 0000 means that all channels are disabled.	
		<b>Setting</b>	<b>Channels Enabled</b>
		0000	All channels disabled.
		0001	Channel 0 enabled.
		0010	Channel 1 enabled.
		0011	Channel 0 and Channel 1 enabled.
		...	...
1110	Channel 1, Channel 2, and Channel 3 enabled.		
1111	All channels enabled.		

Table 18. Bypass Register (Address 0x06)

Bit	Bit Name	Description	
7	QAM	If this bit is set to 1, the QAM mappers are bypassed.	
6	SRRC	If this bit is set to 1, the square root raised cosine (SRRC) filters are bypassed.	
5	Reserved	Reserved.	
[4:0]	INT[4:0]	A Logic 1 in any bit position bypasses the corresponding interpolation filter. The preferred order for bypassing interpolation filters is to first bypass Filter 0, then Filter 1, and so on.	
		<b>Setting</b>	<b>Interpolation Filters Bypassed</b>
		00000	All interpolation filters enabled.
		00001	Interpolation Filter 0 bypassed.
		00010	Interpolation Filter 1 bypassed.
		00011	Interpolation Filter 0 and Interpolation Filter 1 bypassed.
		...	...
		01111	Interpolation Filter 0, Interpolation Filter 1, Interpolation Filter 2, and Interpolation Filter 3 bypassed.
		...	...
11111	All interpolation filters bypassed.		

**Table 19. QAM/SRRC Configuration Register (Address 0x07)**

Bit	Bit Name	Description	
[7:6]	Reserved	Reserved.	
[5:4]	ALPHA[1:0]	These bits set the SRRC filter alpha.	
		<b>Setting</b>	<b>Alpha Filter</b>
		00	0.12
		01	0.18
		10	0.15
11	0.13		
3	Reserved	Reserved.	
[2:0]	MAPPING[2:0]	These bits set the QAM encoding.	
		<b>Setting</b>	<b>QAM Encoding</b>
		000	DOCSIS 64-QAM
		001	DOCSIS 256-QAM
		010	DVB 16-QAM
		011	DVB 32-QAM
		100	DVB 64-QAM
		101	DVB 128-QAM
		110	DVB 256-QAM
		111	Unused

**Table 20. Summing Node Scalar Register (Address 0x08)**

Bit	Bit Name	Description	
[7:0]	SUMSCALE[7:0]	This register sets the value of the 2.6 multiplier that is applied to the output of the channel summing node.	
		<b>Setting</b>	<b>2.6 Multiplier</b>
		00000000	0
		00000001	0.015625
		00000010	0.03125
		...	...
		00001101	0.203125 (default)
		...	...
		11111110	3.96875
		11111111	3.984375

**Table 21. Input Scalar Register (Address 0x09)**

Bit	Bit Name	Description	
[7:0]	INSCALE[7:0]	This register sets the value of the 3.5 multiplier that is applied to the input data. This scaling block is in parallel with the QAM encoder block and is used when the QAM encoder block is bypassed.	
		<b>Setting</b>	<b>3.5 Multiplier</b>
		00000000	0
		00000001	0.03125
		00000010	0.0625
		...	...
		00100000	1 (default)
		...	...
		11111110	7.9375
		11111111	7.96875

The three NCO 0 frequency tuning word registers together compose the 24-bit frequency tuning word for NCO 0. For more information about programming these registers, see the Baseband Digital Upconverter section.

**Table 22. NCO 0 Frequency Tuning Word Registers (Address 0x0A to Address 0x0C)**

Address	Bit Name	Description
0x0A	FTW0[7:0]	Frequency tuning word for NCO 0, Bits[7:0]
0x0B	FTW0[15:8]	Frequency tuning word for NCO 0, Bits[15:8]
0x0C	FTW0[23:16]	Frequency tuning word for NCO 0, Bits[23:16]

The three NCO 1 frequency tuning word registers together compose the 24-bit frequency tuning word for NCO 1. For more information about programming these registers, see the Baseband Digital Upconverter section.

**Table 23. NCO 1 Frequency Tuning Word Registers (Address 0x0D to Address 0x0F)**

Address	Bit Name	Description
0x0D	FTW1[7:0]	Frequency tuning word for NCO 1, Bits[7:0]
0x0E	FTW1[15:8]	Frequency tuning word for NCO 1, Bits[15:8]
0x0F	FTW1[23:16]	Frequency tuning word for NCO 1, Bits[23:16]

The three NCO 2 frequency tuning word registers together compose the 24-bit frequency tuning word for NCO 2. For more information about programming these registers, see the Baseband Digital Upconverter section.

**Table 24. NCO 2 Frequency Tuning Word Registers (Address 0x10 to Address 0x12)**

Address	Bit Name	Description
0x10	FTW2[7:0]	Frequency tuning word for NCO 2, Bits[7:0]
0x11	FTW2[15:8]	Frequency tuning word for NCO 2, Bits[15:8]
0x12	FTW2[23:16]	Frequency tuning word for NCO 2, Bits[23:16]

The three NCO 3 frequency tuning word registers together compose the 24-bit frequency tuning word for NCO 3. For more information about programming these registers, see the Baseband Digital Upconverter section.

**Table 25. NCO 3 Frequency Tuning Word Registers (Address 0x13 to Address 0x15)**

Address	Bit Name	Description
0x13	FTW3[7:0]	Frequency tuning word for NCO 3, Bits[7:0]
0x14	FTW3[15:8]	Frequency tuning word for NCO 3, Bits[15:8]
0x15	FTW3[23:16]	Frequency tuning word for NCO 3, Bits[23:16]

The three rate converter denominator (Q) registers together compose the 24-bit denominator for the rate converter decimation ratio. For more information about programming these registers, see the Sample Rate Converter section.

**Table 26. Rate Converter Denominator (Q) Registers (Address 0x16 to Address 0x18)**

Address	Bit Name	Description
0x16	Q[7:0]	Rate converter denominator, Bits[7:0]
0x17	Q[15:8]	Rate converter denominator, Bits[15:8]
0x18	Q[23:16]	Rate converter denominator, Bits[23:16]

The three rate converter numerator (P) registers together compose the 24-bit numerator for the rate converter decimation ratio. For more information about programming these registers, see the Sample Rate Converter section.

**Table 27. Rate Converter Numerator (P) Registers (Address 0x19 to Address 0x1B)**

Address	Bit Name	Description
0x19	P[7:0]	Rate converter numerator, Bits[7:0]
0x1A	P[15:8]	Rate converter numerator, Bits[15:8]
0x1B	P[23:16]	Rate converter numerator, Bits[23:16]



The two interpolating BPF center frequency registers together compose the 16-bit center frequency of the 16× band-pass interpolation filter. For more information about programming these registers, see the Digital 16× Tunable Band-Pass Filter section.

**Table 28. Interpolating BPF Center Frequency Registers (Address 0x1C and Address 0x1D)**

Address	Bit Name	Description
0x1C	FC[7:0]	Center frequency, Bits[7:0]
0x1D	FC[15:8]	Center frequency, Bits[15:8]

**Table 29. Frequency Update Register (Address 0x1E)**

Bit	Name	Description
7	FREQNEW	Setting this bit to 1 updates the derived registers in the AD9789. This bit must be set for changes to Register 0x16 through Register 0x1D to take effect. This self-clearing bit is reset to 0 after the derived registers are updated.
[6:0]	Reserved	Reserved.

**Table 30. Hardware Version Register (Address 0x1F)**

Bit	Name	Description
[7:4]	Reserved	Reserved.
[3:0]	VER[3:0]	This read-only register indicates the version of the chip (0011).

**Table 31. Interface Configuration Register (Address 0x20)**

Bit	Bit Name	Description										
7	CMOS_BUS	This bit reflects the state of the CMOS_BUS pin (L14).										
6	CMOS_CTRL	This bit reflects the state of the CMOS_CTRL pin (M14).										
5	Reserved	Reserved.										
4	DCO_INV	When set to 1, the DCO pin is inverted.										
3	IF_MODE	This bit sets the data interface mode. 0 = channelizer mode. Supports all available interface widths and 8- and 16-bit word widths. Supports maximum $f_{\text{BAUD}}$ of $f_{\text{DAC}}/48$ . 1 = quadrature digital upconverter (QDUC) mode. Supports 32-bit interface, 16-bit word mode only. Supports maximum $f_{\text{BAUD}}$ of $f_{\text{DAC}}/16$ .										
2	CHANPRI	This bit selects the channel prioritization value (used in channelizer mode only). 0 = device expects input samples only for those channels that are enabled. 1 = device expects data for all four channels. Data for disabled channels is expected and must be sent, but this data is discarded by the AD9789.										
[1:0]	PAR[1:0]	These bits set the parity checking. For more information, see the Parity section.										
		<table border="1"> <thead> <tr> <th>Setting</th> <th>Parity Checking</th> </tr> </thead> <tbody> <tr> <td>00</td> <td>Parity checking deactivated</td> </tr> <tr> <td>01</td> <td>IQ parity (a value of 0 is expected on the I channel and a value of 1 is expected on the Q channel)</td> </tr> <tr> <td>10</td> <td>Even parity</td> </tr> <tr> <td>11</td> <td>Odd parity</td> </tr> </tbody> </table>	Setting	Parity Checking	00	Parity checking deactivated	01	IQ parity (a value of 0 is expected on the I channel and a value of 1 is expected on the Q channel)	10	Even parity	11	Odd parity
Setting	Parity Checking											
00	Parity checking deactivated											
01	IQ parity (a value of 0 is expected on the I channel and a value of 1 is expected on the Q channel)											
10	Even parity											
11	Odd parity											

Table 32. Data Control Register (Address 0x21)

Bit	Bit Name	Description										
7	BIN	This bit selects the coding for the device. 0 = twos complement coding. 1 = straight binary coding.										
[6:5]	BUSWIDTH[1:0]	These bits set the input data bus width for the device.										
		<table border="1"> <thead> <tr> <th>Setting</th> <th>Input Bus Width</th> </tr> </thead> <tbody> <tr> <td>00</td> <td>4 bits</td> </tr> <tr> <td>01</td> <td>8 bits</td> </tr> <tr> <td>10</td> <td>16 bits</td> </tr> <tr> <td>11</td> <td>32 bits</td> </tr> </tbody> </table>	Setting	Input Bus Width	00	4 bits	01	8 bits	10	16 bits	11	32 bits
Setting	Input Bus Width											
00	4 bits											
01	8 bits											
10	16 bits											
11	32 bits											
4	DATWIDTH	This bit sets the data-word width that is sent to the datapaths. 0 = 8-bit data-word. 1 = 16-bit data-word.										
3	CMPLX	This bit configures the datapath for real or complex data. 0 = real data. 1 = complex data.										
[2:0]	LTNCY[2:0]	These bits set the turnaround latency from the FS pulse to the internal data sampling time. For more information, see the Latency Register section.										
		<table border="1"> <thead> <tr> <th>Setting</th> <th>Latency</th> </tr> </thead> <tbody> <tr> <td>000</td> <td>Input data begins to be sampled at approximately the first rising edge of DCO after FS goes low.</td> </tr> <tr> <td>001</td> <td>Input data begins to be sampled at approximately the second rising edge of DCO after FS goes low.</td> </tr> <tr> <td>...</td> <td>...</td> </tr> <tr> <td>111</td> <td>Input data begins to be sampled at approximately the eighth rising edge of DCO after FS goes low.</td> </tr> </tbody> </table>	Setting	Latency	000	Input data begins to be sampled at approximately the first rising edge of DCO after FS goes low.	001	Input data begins to be sampled at approximately the second rising edge of DCO after FS goes low.	...	...	111	Input data begins to be sampled at approximately the eighth rising edge of DCO after FS goes low.
Setting	Latency											
000	Input data begins to be sampled at approximately the first rising edge of DCO after FS goes low.											
001	Input data begins to be sampled at approximately the second rising edge of DCO after FS goes low.											
...	...											
111	Input data begins to be sampled at approximately the eighth rising edge of DCO after FS goes low.											

Table 33. DCO Frequency Register (Address 0x22)

Bit	Bit Name	Description																
7	Reserved	Reserved.																
[6:4]	DCODIV[2:0]	These bits configure the data clock output (DCO) frequency.																
		<table border="1"> <thead> <tr> <th>Setting</th> <th>DCO Clock Frequency</th> </tr> </thead> <tbody> <tr> <td>000</td> <td>DCO clock disabled</td> </tr> <tr> <td>001</td> <td><math>f_{DACCLK}/16</math></td> </tr> <tr> <td>010</td> <td><math>f_{DACCLK}/32</math></td> </tr> <tr> <td>011</td> <td>Invalid</td> </tr> <tr> <td>100</td> <td><math>f_{DACCLK}/64</math></td> </tr> <tr> <td>101</td> <td>Invalid</td> </tr> <tr> <td>11x</td> <td>Invalid</td> </tr> </tbody> </table>	Setting	DCO Clock Frequency	000	DCO clock disabled	001	$f_{DACCLK}/16$	010	$f_{DACCLK}/32$	011	Invalid	100	$f_{DACCLK}/64$	101	Invalid	11x	Invalid
Setting	DCO Clock Frequency																	
000	DCO clock disabled																	
001	$f_{DACCLK}/16$																	
010	$f_{DACCLK}/32$																	
011	Invalid																	
100	$f_{DACCLK}/64$																	
101	Invalid																	
11x	Invalid																	
[3:0]	ONES[3:0]	These bits always read back 1111.																

Table 34. Internal Clock Phase Adjust Register (Address 0x23)

Bit	Bit Name	Description										
[7:4]	DSCPHZ[3:0]	The data sampling clock (DSC) is an internal clock that is used to sample the input data. This clock can occur on 1 of 16 phases to optimize the setup and hold timing of the data interface.										
		<table border="1"> <thead> <tr> <th>Setting</th> <th>Selected Phase</th> </tr> </thead> <tbody> <tr> <td>0000</td> <td>Earliest clock phase</td> </tr> <tr> <td>0001</td> <td>Second earliest clock phase that occurs 1/16 of a DSC cycle later</td> </tr> <tr> <td>...</td> <td>...</td> </tr> <tr> <td>1111</td> <td>Last available clock phase</td> </tr> </tbody> </table>	Setting	Selected Phase	0000	Earliest clock phase	0001	Second earliest clock phase that occurs 1/16 of a DSC cycle later	...	...	1111	Last available clock phase
		Setting	Selected Phase									
		0000	Earliest clock phase									
0001	Second earliest clock phase that occurs 1/16 of a DSC cycle later											
...	...											
1111	Last available clock phase											
[3:0]	SNCPHZ[3:0]	The synchronization clock (SNC) is an internal clock that is used to synchronize the digital datapath clock with the DAC clock. This clock can occur on 1 of 16 phases to optimize the DAC-to-datapath timing.										
		<table border="1"> <thead> <tr> <th>Setting</th> <th>Selected Phase</th> </tr> </thead> <tbody> <tr> <td>0000</td> <td>Earliest clock phase</td> </tr> <tr> <td>0001</td> <td>Second earliest clock phase that occurs 1/16 of a DSC cycle later</td> </tr> <tr> <td>...</td> <td>...</td> </tr> <tr> <td>1111</td> <td>Last available clock phase</td> </tr> </tbody> </table>	Setting	Selected Phase	0000	Earliest clock phase	0001	Second earliest clock phase that occurs 1/16 of a DSC cycle later	...	...	1111	Last available clock phase
Setting		Selected Phase										
0000		Earliest clock phase										
0001	Second earliest clock phase that occurs 1/16 of a DSC cycle later											
...	...											
1111	Last available clock phase											

Table 35. Parameter Update Register (Address 0x24)

Bit	Name	Description
7	PARMNEW	This bit must transition from 0 to 1 for changes to Register 0x22 and Register 0x23 to take effect. Assuming that this bit was previously set to 0, writing a 1 to this bit causes the readback value of the bit to reflect the state of the chip. (The state of the chip is updated very quickly; for this reason, users with slow SPI implementations may never read back a 0 after an update.) 0 = values have not been updated. 1 = values have been updated.
[6:0]	Reserved	Reserved.

Table 36. Channel Gain Registers (Address 0x25 to Address 0x28)

Address	Register Name	Bit Name	Description										
0x25	Channel 0 gain	CHAN0GAIN[7:0]	These registers configure a value for the 1.7 multiplier applied to each individual channel just prior to the SUMSCALE block. The range of the channel gain is 0 to 1.9921875 with a step size of 0.0078125. To mute an individual channel, set the scale factor to 0.										
0x26	Channel 1 gain	CHAN1GAIN[7:0]											
0x27	Channel 2 gain	CHAN2GAIN[7:0]											
0x28	Channel 3 gain	CHAN3GAIN[7:0]											
			<table border="1"> <thead> <tr> <th>Setting</th> <th>Channel Gain</th> </tr> </thead> <tbody> <tr> <td>00000000</td> <td>0</td> </tr> <tr> <td>00000001</td> <td>0.0078125</td> </tr> <tr> <td>...</td> <td>...</td> </tr> <tr> <td>11111111</td> <td>1.9921875</td> </tr> </tbody> </table>	Setting	Channel Gain	00000000	0	00000001	0.0078125	...	...	11111111	1.9921875
Setting	Channel Gain												
00000000	0												
00000001	0.0078125												
...	...												
11111111	1.9921875												

Table 37. Spectrum Shaping Register (Address 0x29)

Bit	Name	Description
[7:1]	Reserved	Reserved.
0	SPEC_INV	Setting this bit to 1 spectrally inverts the signal, effectively multiplying the Q data by $-1$ .

Table 38. Mu Delay Control 1 Register (Address 0x2F)

Bit	Bit Name	Description												
7	SEARCH_TOL	This bit specifies the accuracy of the phase search. The optimal value for this bit is 1. 0 = not exact: the search can find a phase within two values of the desired phase. 1 = exact: the search finds the exact phase specified.												
6	SEARCH_ERR	This bit configures the search behavior when an error is encountered. 0 = stop on error. 1 = retry on error.												
5	TRACK_ERR	This bit configures the track behavior if the controller does not find the desired phase. The optimal value for this bit is 0. 0 = continue on error. 1 = reset on error.												
[4:0]	GUARDBAND[4:0]	These bits set the guard band value. The guard band is defined as follows: GUARDBAND[4:0] × 8 = number of mu delay codes of guard band from the endpoints If the search mode is alternating, the search proceeds in both directions until the guard band is reached in one direction. When the guard band is reached, the search continues only in the opposite direction. If the desired phase is not found before the guard band is reached in the second direction, the search reverts to the alternating mode and continues looking within the guard band. The search fails if the mu delay reaches the endpoints. For more information, see the Mu Delay Controller section.												
		<table border="1"> <thead> <tr> <th>Setting</th> <th>Guard Band</th> </tr> </thead> <tbody> <tr> <td>00000</td> <td>0</td> </tr> <tr> <td>...</td> <td>...</td> </tr> <tr> <td>01011</td> <td>11 (default)</td> </tr> <tr> <td>...</td> <td>...</td> </tr> <tr> <td>11111</td> <td>31</td> </tr> </tbody> </table>	Setting	Guard Band	00000	0	...	...	01011	11 (default)	...	...	11111	31
Setting	Guard Band													
00000	0													
...	...													
01011	11 (default)													
...	...													
11111	31													

Table 39. Mu Control Duty Cycle Register (Address 0x30)

Bit	Bit Name	Description
7	Duty cycle correct enable	Setting this bit to 1 turns on the mu control duty cycle correction circuitry. Turn on this function before enabling the mu controller. Along with the phase comparator boost (enabled in Register 0x3E[5]), this function allows for more robust operation of the mu controller over the entire operating speed of the part.
6	INC_DEC	Reserved (factory use only).
[5:0]	MANUAL_ADJ[5:0]	Reserved (factory use only).

Table 40. Clock Receiver 1 Register (Address 0x31)

Bit	Bit Name	Description
[7:4]	CLKN_CML[3:0]	These bits adjust the common-mode level at the CLKN pin. The recommended value for these bits and the CLKP_CML[3:0] bits is 0xF. For more information, see the Optimizing the Clock Common-Mode Voltage section.
[3:0]	Reserved	Reserved.

Table 41. Clock Receiver 2 Register (Address 0x32)

Bit	Bit Name	Description
7	CLK_DIS	This bit disables or enables the clock receiver. When the AD9789 powers up, this bit is set to 0 to prevent severe output noise that occurs on power-up with no clock. When the DAC clock is stable, set this bit to 1. 0 = disabled. 1 = enabled.
6	Reserved	Reserved (factory use only; leave at default value).
5	PSIGN	This bit specifies the sign for the CLKP_CML bits. 0 = negative (recommended). 1 = positive.
[4:1]	CLKP_CML[3:0]	These bits adjust the common-mode level at the CLKP pin. The recommended value for these bits and the CLKN_CML[3:0] bits is 0xF. For more information, see the Optimizing the Clock Common-Mode Voltage section.
0	NSIGN	This bit specifies the sign for the CLKN_CML bits. 0 = negative (recommended). 1 = positive.

**Table 42. Mu Delay Control 2 Register (Address 0x33)**

Bit	Bit Name	Description
7	MU_CLKDIS	This bit disables or enables the clock to the mu delay controller. 0 = enabled. 1 = disabled.
6	SLOPE	This bit configures the desired slope for the phase measurement of the mu delay. When the desired phase is measured, the slope of the phase measurement is calculated and compared to the value of this bit. For optimal ac performance, the best setting for the search is a positive slope and a phase value of 14. 0 = negative. 1 = positive.
[5:4]	MODE[1:0]	These bits configure the mode of operation for the mu controller. 00 = search and track (recommended). 01 = track only. 10 = search only. 11 = invalid.
3	MUSAMP	Transitioning this bit from 0 to 1 enables the user to read back the mu delay value that the controller locked to (the MUDLY bits in Register 0x39 and Register 0x3A), as well as the phase that it locked to (the MUPHZ bits in Register 0x39). 0 = no action. 1 = transition from 0 to 1 captures the readback of the mu controller phase and delay.
[2:1]	GAIN[1:0]	These bits set the tracking rate of the mu controller. 00 = slowest tracking. 01 = nominal tracking (recommended). 10 = fastest tracking. 11 = invalid (do not use).
0	MU_EN	This bit enables or disables the mu controller. Before enabling the mu controller, turn on both the phase comparator boost (Register 0x3E[5]) and the mu control duty cycle correction circuitry (Register 0x30[7]). Both of these functions allow for more robust operation of the mu controller over the entire operating speed of the part. 0 = mu controller off (manual mode). 1 = mu controller on (auto mode).

**Table 43. DAC Bias Register (Address 0x36)**

Bit	Bit Name	Description
7	PDBIAS	Setting this bit to 1 powers down the DAC circuitry.
[6:2]	Reserved	Reserved.
[1:0]	MSEL[1:0]	These bits set the mirror roll-off frequency control, which can be used to adjust the noise contribution of the internal current mirror to optimize the 1/f noise. 00 = bypass the mirror roll-off frequency control. 01 = narrowest bandwidth. 10 = medium bandwidth. 11 = widest bandwidth.

**Table 44. DAC Decoder Register (Address 0x38)**

Bit	Bit Name	Description
[7:2]	Reserved	Reserved.
[1:0]	DAC decoder mode	These bits set the decoder mode for the DAC. It is recommended that normal mode (the default) be used. 00 = normal mode. 01 = return to zero mode. 10 = mix mode. 11 = invalid.

Table 45. Mu Delay Control 3 Register (Address 0x39)

Bit	Bit Name	Description
7	MUDLY[0]	This bit is the LSB of the mu delay value. Along with Bits[7:0] in Register 0x3A, this bit configures the programmable mu delay; the search algorithm begins at this specified mu delay value. In manual mode, the MUDLY bits can be written to. In tracking mode, the sampled MUDLY value can be read back. Even though there are 9 bits of resolution for this delay line value, the maximum allowable mu delay is 431 (0x1AF). The optimal point to begin the search is in the middle of the delay line, or approximately 216 (0xD8).
[6:5]	SEARCH_DIR[1:0]	These bits configure the search direction, starting at the selected mu delay value. 00 = search down. 01 = search up. 10 = search up and down (optimal). 11 = invalid.
[4:0]	MUPHZ[4:0]	These bits specify the phase to be measured with the maximum allowable phase being 16 (10000). If a value larger than 16 is loaded, the controller will not lock. When the desired phase is measured, the slope of the phase measurement is calculated and compared to the configured slope, which is specified by the SLOPE bit in Register 0x33[6]. For optimal ac performance, the best setting for the search is for a positive slope and a phase value of 14 (01110).

Table 46. Mu Delay Control 4 Register (Address 0x3A)

Bit	Bit Name	Description
[7:0]	MUDLY[8:1]	Along with Bit 7 in Register 0x39, these bits configure the programmable mu delay; the search algorithm begins at this specified mu delay value. In manual mode, the MUDLY bits can be written to. In tracking mode, the sampled MUDLY value can be read back. Even though there are 9 bits of resolution for this delay line value, the maximum allowable mu delay is 431 (0x1AF). The optimal point to begin the search is in the middle of the delay line, or approximately 216 (0xD8).

Table 47. Full-Scale Current 1 Register (Address 0x3C)

Bit	Bit Name	Description																
[7:0]	FSC[7:0]	Along with Bits[1:0] in Register 0x3D, this register sets the full-scale current for the DAC. For more information, see the Voltage Reference section.																
		<table border="1"> <thead> <tr> <th>Setting (Includes Register 0x3D[1:0])</th> <th>Full-Scale Current (mA)</th> </tr> </thead> <tbody> <tr> <td>000000000</td> <td>8.6</td> </tr> <tr> <td>...</td> <td>...</td> </tr> <tr> <td>100000000</td> <td>20 (default)</td> </tr> <tr> <td>...</td> <td>...</td> </tr> <tr> <td>101101000</td> <td>25</td> </tr> <tr> <td>...</td> <td>...</td> </tr> <tr> <td>111111111</td> <td>32.1</td> </tr> </tbody> </table>	Setting (Includes Register 0x3D[1:0])	Full-Scale Current (mA)	000000000	8.6	...	...	100000000	20 (default)	...	...	101101000	25	...	...	111111111	32.1
Setting (Includes Register 0x3D[1:0])	Full-Scale Current (mA)																	
000000000	8.6																	
...	...																	
100000000	20 (default)																	
...	...																	
101101000	25																	
...	...																	
111111111	32.1																	

Table 48. Full-Scale Current 2 Register (Address 0x3D)

Bit	Bit Name	Description
[7:2]	Reserved	Reserved.
[1:0]	FSC[9:8]	Along with the FSC[7:0] bits in Register 0x3C, these bits set the full-scale current for the DAC. For more information, see Table 47 and the Voltage Reference section.

Table 49. Phase Detector Control Register (Address 0x3E)

Bit	Bit Name	Description
7	PHZ_PD	Powers down the phase detector. This bit is for factory use only; this bit should be set to 0.
6	Reserved	Reserved.
5	CMP_BST	Comparator boost. This bit is for factory use only; this bit should always be set to 1.
4	AUTO_CAL	This bit is for factory use only; this bit should always be set to 1.
[3:0]	PHZ_DET_BIAS[3:0]	These bits display the binary weighted current. Do not write to these bits (factory use only).

## THEORY OF OPERATION

The AD9789 is a flexible digital signal processing (DSP) engine combined with a high performance, 2400 MSPS, 14-bit DAC (Figure 70). The DSP blocks include a QAM encoder, a 2× upsampling square root raised cosine (SRRC) filter, selectable interpolation from 16× to 512×, a rate converter, and a complex modulator. The digital interface can accept up to four channels of complex data. The QAM encoder supports constellation sizes of 16, 32, 64, 128, and 256. The on-chip rate converter allows fine resolution of baud rates with a fixed DAC sampling clock. The digital upconverters can place the input signals from dc to  $0.5 \times f_{DAC}$ . An analog mix mode extends the output spectrum into the second and third DAC Nyquist zones.

Control of the AD9789 functions is via a serial peripheral interface (SPI).

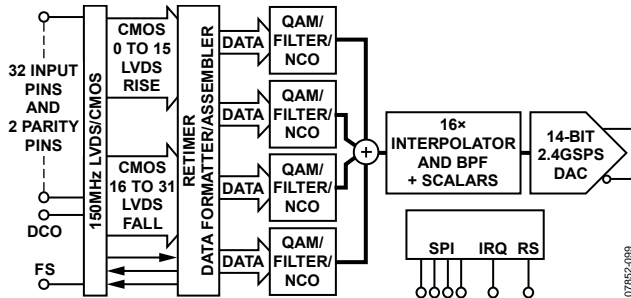

Figure 70. Top Level Functional Block Diagram

## DATAPATH SIGNAL PROCESSING

The DSP blocks included on the AD9789 can be grouped into two sections. The first is the datapath signal processing. Four identical datapaths, or channels, can be used. A block diagram of a single channel is shown in Figure 71. Enabling and disabling each DSP block within the datapath takes effect on all channels. There is independent control of the scaling and the frequency placement of each channel.

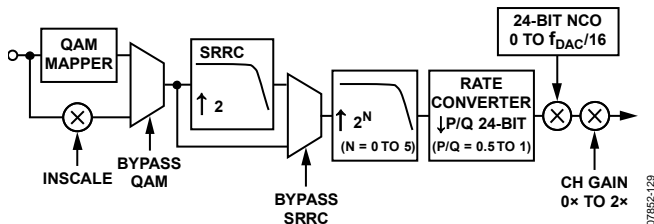

Figure 71. Datapath Block Diagram

The following sections describe each of the DSP blocks included in the datapath.

## QAM Encoder

The QAM encoder supports seven different standards-compliant mappings. (For illustrations of the supported mappings, see the QAM Constellation Maps section.) The QAM encoder receives input data-words of 8 bits in width and maps them into 16, 32, 64, 128, or 256 point constellations. It outputs 5-bit complex QAM modulated samples. The mode in which the QAM encoder runs is selected via the QAM/SRRC configuration register (Register 0x07[2:0]).

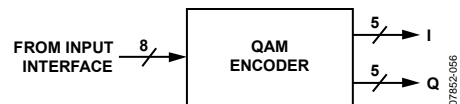

Figure 72. QAM Encoder I/O

Table 50 lists the available QAM mapper modes along with the corresponding input bits and output range. The operation of the QAM encoder when configured in DOCSIS 64-QAM mode is described in this section. The operation of the QAM encoder in the other modes is conceptually the same; only the input data bit encoding and scale factors are different.

The DOCSIS 64-QAM constellation diagram is shown in Figure 73. The constellation diagram shows how the QAM encoder input is mapped into the QAM constellation. For example, an input data-word of 111111 maps to the constellation point in the upper right corner of the 64-QAM constellation.

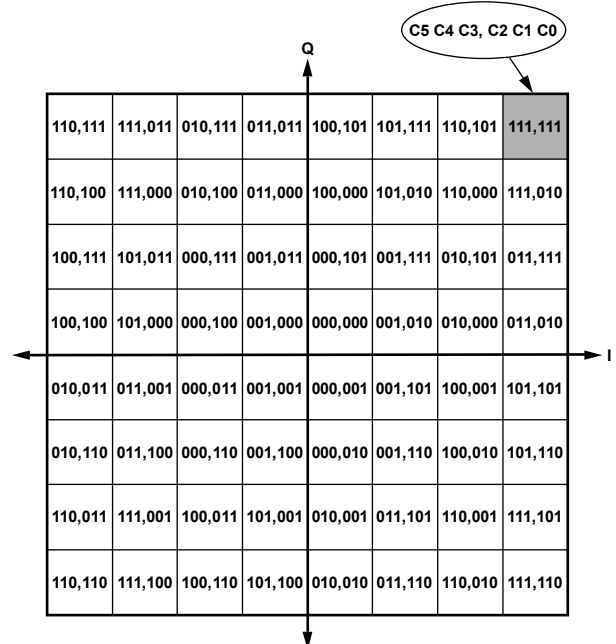

Figure 73. DOCSIS 64-QAM Constellation

Table 50. QAM Mapper Input and Output Range vs. Mode

ITU-T J.83 Annex	Description	SPI Register 0x07, MAPPING[2:0] Bits	Bit Range at Output	Input Bits B7 B6 B5 B4 B3 B2 B1 B0 <sup>1</sup>
B	DOCSIS 64-QAM	000	-14 to +14	X X C5 C4 C3 C2 C1 C0
B	DOCSIS 256-QAM	001	-15 to +15	C7 C6 C5 C4 C3 C2 C1 C0
A	DVB 16-QAM	010	-15 to +15	X X X X C3 C2 C1 C0
A	DVB 32-QAM	011	-15 to +15	X X X C4 C3 C2 C1 C0
A and C	DVB 64-QAM	100	-14 to +14	X X C5 C4 C3 C2 C1 C0
A and C	DVB 128-QAM	101	-11 to +11	X C6 C5 C4 C3 C2 C1 C0
A and C	DVB 256-QAM	110	-15 to +15	C7 C6 C5 C4 C3 C2 C1 C0
	Unused	111		

<sup>1</sup> X = don't care.

Each constellation point corresponds to an I and Q coordinate pair, as shown in Figure 74. In the figure, two symbols are highlighted in a 64-QAM constellation: I = 14, Q = 14 (Pair 1) and I = 6, Q = -10 (Pair 2).

To represent the I and Q coordinate points, 5-bit, two's complement numbers are used. For example, an input of 011101 into the QAM encoder maps to the I = 6, Q = -10 position of the QAM-64 constellation and results in output samples of I = 00110, Q = 10110.

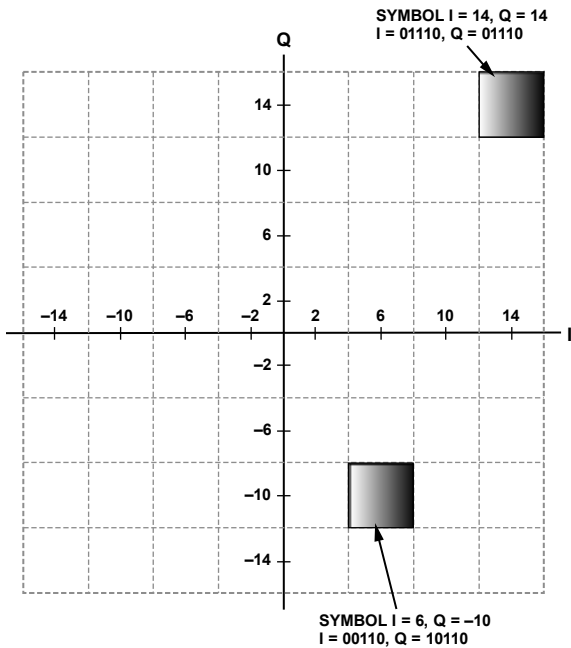

Figure 74. I and Q Symbol Mapping

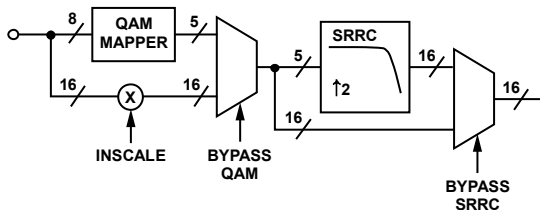

Figure 75. QAM Mapper and SRRC Filter Detail (I and Q Paths Are Identical So Only One Is Shown)

### Input Scalar

The input scalar block is active only when the QAM mapper is bypassed. The value of INSCALE[7:0] is programmed in Register 0x09[7:0]. The scale factor applied to the input data is calculated as follows:

$$ScaleFactor = \frac{INSCALE[7:0]}{32}$$

This factor provides a scaling range of the input data from 0 to 7.96875 in steps of 0.03125. The default value of 0x20 provides a scale factor of 1. As shown in Figure 76, the output of the input scalar block is rounded to the nearest 16-bit value. If the output exceeds the maximum or minimum value, it is clipped to either positive or negative full scale (0x7FFF or 0x8000).

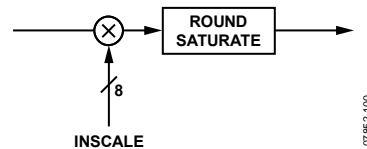

Figure 76. Input Scalar Block Diagram

### SRRC Filter

The square root raised cosine (SRRC) filter performs a 2× interpolation and filtering operation on the input data. The SRRC filter has a pass band, transition band, and stop band requirement as per the DOCSIS, Euro-DOCSIS, and DVB standards.

To cover all the standards, the value of alpha can be set to 0.12, 0.13, 0.15, or 0.18. This value is programmed in Register 0x07[5:4]. The frequency,  $f_N$ , is determined by the input data baud rate. The response of the SRRC filter is illustrated in Figure 77.

The SRRC filter accepts only five bits at its input and can be bypassed (Register 0x06[6]). If the SRRC filter is the first block enabled in the datapath, these five bits are the five MSBs of the 8-bit data-word.



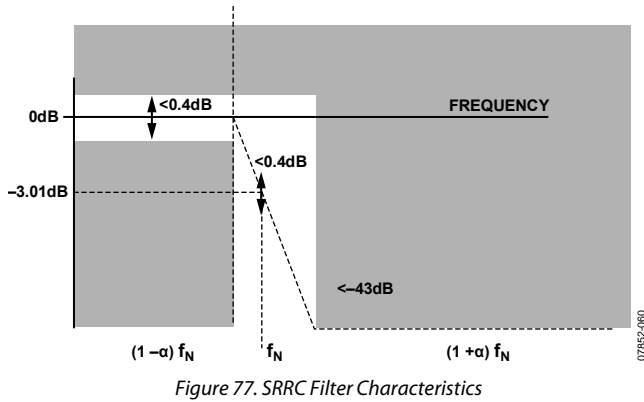

Figure 77. SRRC Filter Characteristics

If the SRRC filter is used, at least four of the  $2\times$  interpolation filters must be enabled. The reason for this is that the SRRC filter requires a minimum of 12 clock cycles at the  $f_{DAC}/16$  rate per sample to function properly.

**Half-Band Interpolation Filters**

The AD9789 can provide from  $1\times$  to  $32\times$  interpolation through the datapath using five bypassable half-band interpolation filters. The half-band interpolation filters are controlled via Register 0x06[4:0]. The preferred order in terms of power savings for bypassing these filters is to bypass Filter 0 first, then Filter 1, and so on. The frequency response of the low-pass filters is shown in Figure 79 through Figure 82. All of the filters have a pass band of  $0.8 \times f_{INPUT}$ , where  $f_{INPUT}$  is the data rate at the input of each filter. The pass band is flat to within 0.01 dB for all filters. The stop-band attenuation exceeds 85 dB in Filter 0, Filter 1, and Filter 2, and 75 dB in Filter 3 and Filter 4.

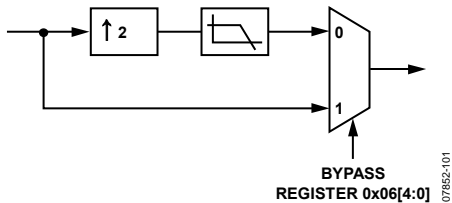

Figure 78. Conceptual Block Diagram of  $2\times$  Half-Band Interpolation Filters

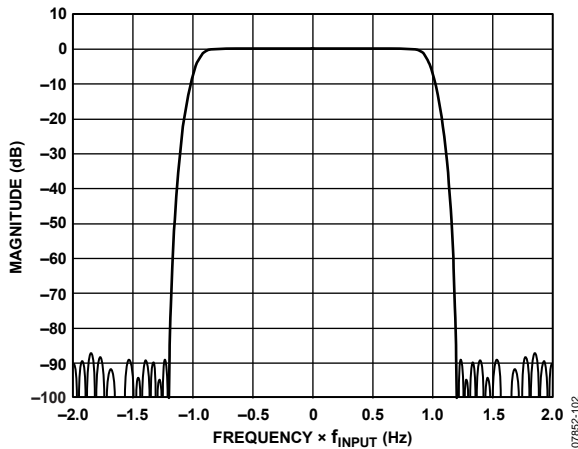

Figure 79.  $2\times$  Half-Band Interpolation Filter 0 Response

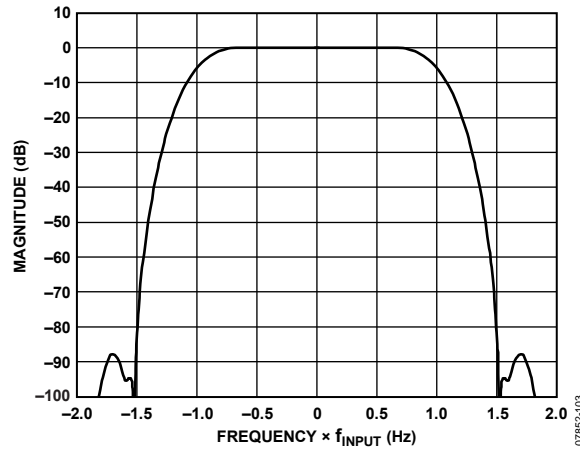

Figure 80.  $2\times$  Half-Band Interpolation Filter 1 Response

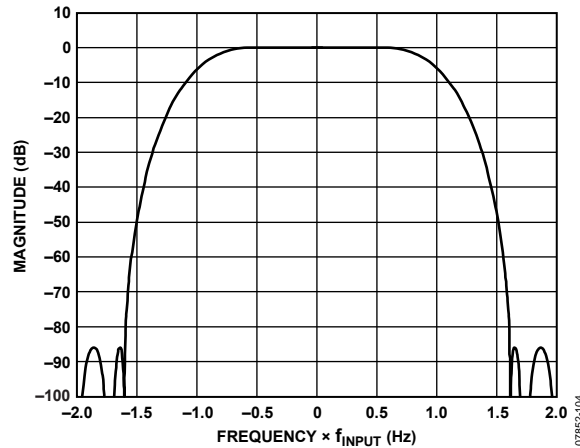

Figure 81.  $2\times$  Half-Band Interpolation Filter 2 Response

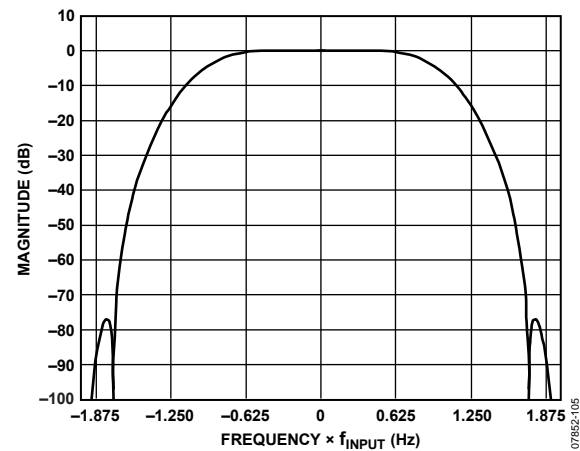

Figure 82.  $2\times$  Half-Band Interpolation Filter 3 and Filter 4 Response

### Sample Rate Converter

The purpose of the sample rate converter (SRC) is to provide increased flexibility in the ratio of the input baud rate to the DAC update rate. Each of the four channelization datapaths contains a sample rate converter (SRC) that provides a data rate conversion in the range of 0.5 to 1.0 inclusive. The rate conversion factor is set by the ratio of two 24-bit values, P and Q. Figure 83 is a conceptual block diagram of the SRC. It can be thought of as an interpolation block, followed by filtering and decimation blocks.

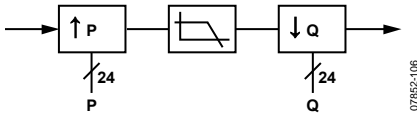

Figure 83. Conceptual Block Diagram of the Sample Rate Converter

The values of P and Q are set by programming the P[23:0] and Q[23:0] registers at Address 0x16 through Address 0x1B.

**Table 51. Register Locations for Sample Rate Converter**

Bits	Numerator (P)	Denominator (Q)
[23:16] (Byte 2)	Register 0x1B	Register 0x18
[15:8] (Byte 1)	Register 0x1A	Register 0x17
[7:0] (Byte 0)	Register 0x19	Register 0x16

The values of P and Q should be selected to satisfy the following equation for the desired baud rate ( $f_{BAUD}$ ) and DAC clock frequency ( $f_{DAC}$ ).

$$f_{DAC} = I \times \frac{P}{Q} \times 16 \times f_{BAUD} \quad (1)$$

where  $I$  is the total interpolation ratio of the SRRC filter and the five half-band interpolation filters.

If Equation 1 is satisfied, the long-term baud rate,  $f_{BAUD}$ , is exactly maintained. No residual frequency offset errors are introduced by the rate conversion process.

The values of P and Q must be selected within the following constraints:

$$0.5 \leq \frac{P}{Q} \leq 1.0 \quad (2)$$

$$Q[23] = 1 \quad (3)$$

Equation 3 states that the value of Q must be shifted so that the MSB of Q is set.

In most systems, the baud rate is a given, and the DAC sample rate is selected so that it is high enough to support the signal bandwidth and output frequency requirements. In many cases, it is desirable to set the DAC clock rate to a multiple of a system clock rate. The following example shows how P and Q can be selected in such a system.

### Example

A DOCSIS application has a master system clock that runs at a frequency of  $f_{MASTER}$ . Several channel baud rates are supported, all of which are fractions of the master clock and can be represented by the following equation:

$$f_{BAUD} = \frac{M}{N} \times f_{MASTER} \quad (4)$$

Equation 1 must be satisfied for  $f_{BAUD}$  to be exactly maintained. To facilitate this, the DAC sampling frequency is selected to be a multiple of  $f_{MASTER}$  that satisfies the signal bandwidth and output frequency requirements. For  $f_{MASTER} = 10.24$  MHz, a signal bandwidth requirement of 32 MHz or greater, and a supported output frequency band of up to 1 GHz, the following DAC sampling frequency can be selected:

$$f_{DAC} = 224 \times f_{MASTER} = 2293.76 \text{ MHz} \quad (5)$$

Inserting Equation 4 and Equation 5 into Equation 1 results in Equation 6.

$$224 \times f_{MASTER} = I \times \frac{P}{Q} \times 16 \times \frac{M}{N} \times f_{MASTER} \quad (6)$$

Enabling the SRRC filter and four of the half-band interpolation filters would result in the total interpolation factor,  $I$ , being equal to 32. Substituting 32 for  $I$  and simplifying Equation 6 results in Equation 7.

$$\frac{P}{Q} = \frac{N}{M} \times \frac{7}{16} \quad (7)$$

Recall that  $N$  and  $M$  are given by the required baud rate. For example, assume a baud rate of 5.0569 MHz, which results from  $M = 401$  and  $N = 812$ .

$$f_{BAUD} = \frac{401}{812} \times 10.24 \text{ MHz} = 5.0569 \text{ MHz} \quad (8)$$

P and Q can then be calculated from the numerator and denominator of Equation 9.

$$\frac{P}{Q} = \frac{812}{401} \times \frac{7}{16} = \frac{5684}{6416} = \frac{0x1634}{0x1910} \quad (9)$$

Because the value of Q must be MSB justified, both numbers can be shifted by 11 bits, resulting in the final P and Q values of 0xB1A000 and 0xC80000, respectively.

### Baseband Digital Upconverter

The digital upconverter enables each baseband channel to be placed anywhere from dc to  $f_{DAC}/16$ . The center frequency for each of the four channels is register programmable through the 24-bit frequency tuning words, FTW 0 through FTW 3. For the desired center frequency of each individual channel, the FTW can be calculated as follows:

$$FTW = \frac{f_{CENTER}}{\left(\frac{f_{DAC}}{16}\right)} \times (2^{24} - 1)$$

The calculated FTW for each channel should be entered into the register locations listed in Table 52.

**Table 52. Register Locations of FTWs for Each Channel**

FTW	Channel 0	Channel 1	Channel 2	Channel 3
[23:16]	Reg. 0x0C	Reg. 0x0F	Reg. 0x12	Reg. 0x15
[15:8]	Reg. 0x0B	Reg. 0x0E	Reg. 0x11	Reg. 0x14
[7:0]	Reg 0x0A	Reg 0x0D	Reg 0x10	Reg 0x13

The FTW sets the frequency of the sine and cosine signals generated by the numerically controlled oscillator (NCO). The complex output from the NCO is multiplied by the input datapath signal to modulate the signal to the desired output frequency. A conceptual block diagram of the baseband digital upconverter is shown in Figure 84.

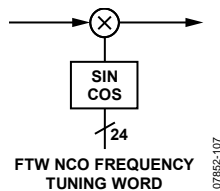

Figure 84. Conceptual Block Diagram of the Baseband Digital Upconverter

**Individual Channel Scalar**

The last block in the datapath is an 8-bit scalar (Register 0x25 Register 0x28) intended for compensating out any sampling and hardware roll-offs that may be encountered. The scale factor applied to each channel is calculated as follows:

$$ScaleFactor = \frac{CHANxGAIN[7:0]}{128}$$

The range of the channel gain is 0 to 1.9921875 with a step size of 0.0078125. An individual channel can be easily and quickly muted, if desired, by setting the scale factor to 0.

**Table 53. Register Locations for Channel Gain Scalar**

CHANxGAIN	Channel 0	Channel 1	Channel 2	Channel 3
[7:0]	Reg. 0x25	Reg. 0x26	Reg. 0x27	Reg. 0x28

The default value of the channel gain provides a scale factor of 1. As shown in Figure 85, the output of the input scalar block is rounded to the nearest 16-bit value. If the output exceeds the maximum or minimum value, it is clipped to either positive or negative full scale (0x7FFF or 0x8000).

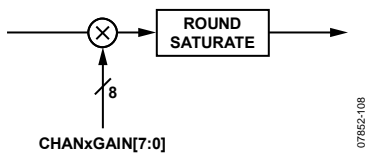

Figure 85. Individual Channel Gain Control

**DIGITAL BLOCK UPCONVERTER**

The second half of the DSP engine on the AD9789 combines the outputs of the four datapaths into one block, scales the block of channels, interpolates by 16x to the full DAC rate, and performs a band-pass filter operation allowing the block of channels to be placed anywhere in the Nyquist bandwidth of the DAC.

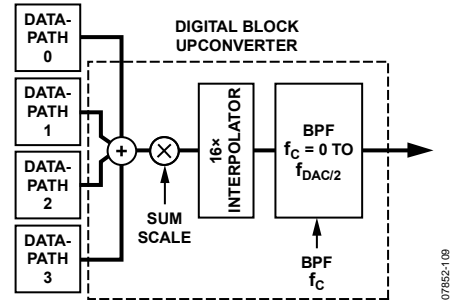

Figure 86. Functional Block Diagram of the Digital Block Upconverter

Each block of the digital block upconverter is described in more detail in the following sections.

**Summing Junction Scalar**

The summing junction scalar block operates on the sum of the four channels. The value of SUMSCALE[7:0] is programmed in Register 0x08. The scale factor applied to the data is calculated as follows:

$$ScaleFactor = \frac{SUMSCALE[7:0]}{64}$$

This factor provides a scaling range of the input data from 0 to 3.984375 with a step size of 0.015625. The default value of 0x0D provides a scale factor of 0.203125. Note that when the channels are summed, they are clipped at the output of the summing junction scalar block if the value exceeds the maximum or minimum full-scale value (0x7FFF or 0x8000). If the full 16-bit range of each individual channel is used, the sum scalar should be set to 0x10 (0.25) to avoid the possibility of clipping.

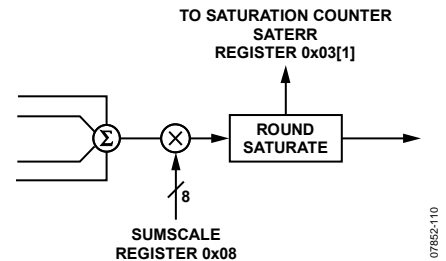

Figure 87. Block Diagram of the Summing Junction Scalar

In practice, the signal-to-noise ratio (SNR) of the channel can be improved by increasing the sum scale factor and permitting a small amount of clipping. The larger signal amplitude can improve the SNR if the clipping is brief and infrequent.

Table 54 shows recommended sum scale values for each QAM mapper mode. The criteria used to determine the recommended sum scale values were MER/EVM measurements and spectral purity. Because clipping results in impulsive noise, it can be observed in the output spectrum as a transient increase in the output noise floor. These sum scale values were chosen such that the transient increases in the noise floor were minimal. These tests were completed for one, two, three, and four carrier outputs at approximately 850 MHz. Because clipping can occur in the RF chain following the DAC, further verification of these values should be performed at the system level by adding BER tests to the sum scale selection criteria.

**Table 54. Recommended Sum Scale Values for all QAM Mapper Modes and Channel Count**

QAM Mode	Sum Scale Value (Decimal)			
	1 Channel	2 Channels	3 Channels	4 Channels
DVB 16-QAM	48	28	22	16
DVB 32-QAM	54	34	26	20
DVB 64-QAM	54	34	26	20
DVB 128-QAM	80	50	38	30
DVB 256-QAM	54	34	26	20
DOCSIS 64-QAM	54	34	26	20
DOCSIS 256-QAM	54	34	26	20

**Digital 16x Tunable Band-Pass Filter**

The digital band-pass filter works in conjunction with a fixed 16x interpolator (see Figure 88). The 16x interpolation filter creates 16 images of the baseband signal in the Nyquist band of the DAC. The digital band-pass filter must then be tuned to reject the 15 undesired images. The center frequency of the band-pass filter can be placed anywhere from dc to  $f_{DAC}/2$ . The tuning word for the band-pass filter center frequency can be calculated as follows:

$$BPF\_Center\_Freq = \frac{f_{CENTER}}{\left(\frac{f_{DAC}}{2}\right)} \times (2^{16} - 1)$$

The resulting tuning word is a 16-bit value where the most significant byte is written to Register 0x1D[7:0] and the least significant byte is written to Register 0x1C[7:0].

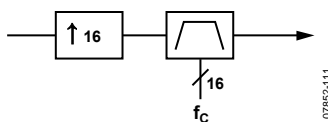

Figure 88. Conceptual Block Diagram of 16x Tunable Band-Pass Filter

The width of the filter's stop band is fixed at approximately  $f_{DAC}/64$ ; therefore, the effective pass band is  $f_{DAC}/64$ . As can be inferred from Figure 89 to Figure 91, mistuning can result in images appearing with little or no impact on the desired signal.

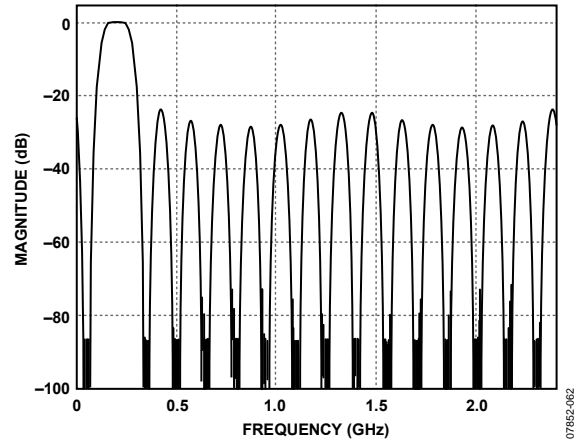

Figure 89. Band-Pass Filter Response at 200 MHz,  $f_{DAC} = 2.4$  GHz

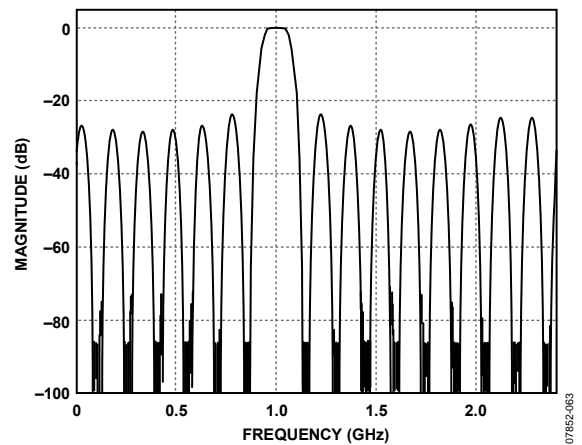

Figure 90. Band-Pass Filter Response at 1 GHz,  $f_{DAC} = 2.4$  GHz

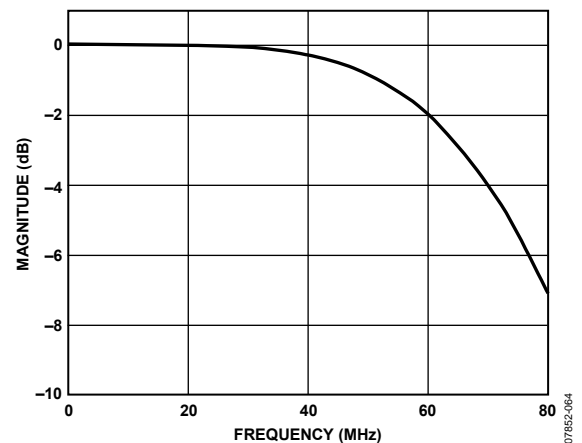

Figure 91. Band-Pass Filter Pass-Band Detail,  $f_{DAC} = 2.4$  GHz

## DIGITAL INTERFACE MODES

The AD9789 can be configured for two main digital interface modes of operation:

- Channelizer mode
- Quadrature digital upconverter (QDUC) mode

In channelizer mode (Register 0x20[3] = 0), the interface can be configured for 4- to 32-bit bus widths and can accept up to four channels of complex data. Any of the signal processing blocks in the digital datapath can be used. The maximum baud rate supported in channelizer mode is  $f_{DAC}/48$ .

In QDUC mode (Register 0x20[3] = 1), the interface is fixed at a 32-bit bus width and one channel of complex data. The available signal processing methods are interpolation ( $16\times$  to  $512\times$ ), rate conversion (0.5 to 1.0), and complex modulation. The maximum baud rate supported in QDUC mode is  $f_{DAC}/16$ .

In both channelizer and QDUC modes, the input data bus can be configured to accept LVDS or CMOS data via the CMOS\_BUS pin (L14). If CMOS\_BUS is pulled to 3.3 V, the data bus is configured to accept CMOS inputs (D[31:0], P0, and P1). If CMOS\_BUS is pulled to 0 V, the bus is configured to accept LVDS inputs (D[15:0]P, D[15:0]N, PARN, and PARN).

Two output signals are used to source data into the AD9789. The first is the data clock output signal (DCO), which is provided to clock data from the digital data source. DCO is a divided-down version of DACCLK. The second is the frame sync signal (FS), which is provided to request a new data-word. The average frequency of the FS signal is equal to the symbol rate or baud rate of the data. As with the input data bus, the DCO and FS signals can be configured as LVDS or CMOS outputs via the CMOS\_CTRL pin (M14). If CMOS\_CTRL is pulled to 3.3 V, DCO and FS are output as CMOS signals on the P14 and N14 pins (CMOS\_DCO and CMOS\_FS), respectively. If CMOS\_CTRL is pulled to 0 V, DCO and FS are output as LVDS signals on the N13, P13, L13, and M13 pins (DCOP, DCON, FSP, and FSN), respectively.

### Channelizer Mode

In channelizer mode, the digital interface has programmable bus width, data width, and data format. The bus width, which is the physical width of the digital data bus at the input of the AD9789, can be set to a 4-, 8-, 16-, or 32-bit wide interface. The data width, which is the internal width of the data at the input to the digital datapath, can be set to an 8-bit or 16-bit word. The data format can be programmed for real or complex data. A list of supported interface modes is shown in Table 55.

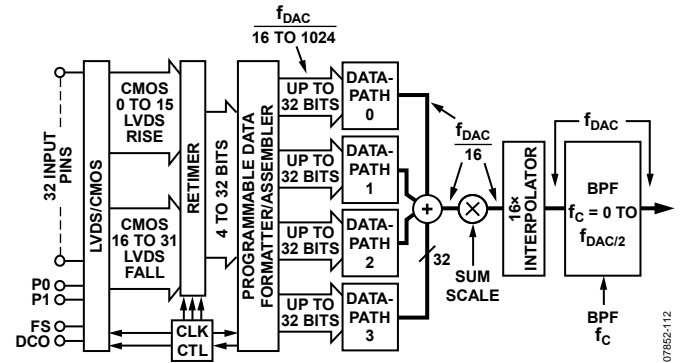

Figure 92. Channelizer Mode

Table 55. Interface Configurations Supported in Channelizer Mode

First Input Block Enabled	Bus Width Reg. 0x21[6:5]	Data Width Reg. 0x21[4]	Data Format Reg. 0x21[3]
QAM Encoder	32 bits	8 bits	Real
	16 bits	8 bits	Real
	8 bits	8 bits	Real
	4 bits	8 bits	Real
SRRC Filter	32 bits	8 bits	Complex
	16 bits	8 bits	Complex
	8 bits	8 bits	Complex
	4 bits	8 bits	Complex
Interpolation Filter	32 bits	16 bits	Complex
	16 bits	16 bits	Complex
	8 bits	16 bits	Complex

If the QAM encoder is the first block enabled in the datapath, the data width should be set to an 8-bit word and real data format. If the SRRC filter is the first block enabled in the datapath, the data width should be set to an 8-bit word and complex data format. If both the QAM encoder and the SRRC filters are bypassed, the data width should be set to a 16-bit word and complex data format.

### Pin Mapping in Channelizer Mode

In CMOS mode (CMOS\_BUS and CMOS\_CTRL pins = 3.3 V), the various interface width options are mapped to the AD9789 input pins as shown in Table 56.

Table 56. CMOS Pin Assignments for Various Interface Widths

Interface Width	Pin Assignments	BUSWDTH[1:0]
4 bits	D[3:0]	00
8 bits	D[7:0]	01
16 bits	D[15:0]	10
32 bits	D[31:0]	11

In LVDS mode, the various interface width options are mapped to the AD9789 input pins as shown in Table 57. When the interface width is set to 32 bits in LVDS mode, the interface becomes double data rate (DDR). In DDR mode, the first 16 bits are sampled on the rising edge of the data sampling clock (DSC, which is synchronous to DCO), and the second 16 bits are sampled on the falling edge of DSC. All other interface widths are single data rate (SDR), where the input data is sampled on the falling edge of DSC.

**Table 57. LVDS Pin Assignments for Various Interface Widths**

Interface Width	Pin Assignments	BUSWIDTH[1:0]
4 bits	D[3:0]P, D[3:0]N	00
8 bits	D[7:0]P, D[7:0]N	01
16 bits	D[15:0]P, D[15:0]N	10
32 bits	D[15:0]P, D[15:0]N rising edge and falling edge	11

In nibble or byte loading, the most significant nibble or byte should be loaded first. Data for Channel 0 should be loaded first followed by Channel 1, Channel 2, and Channel 3. In complex data format, the in-phase part should be loaded before the quadrature part of the data-word. The data bus is LSB justified when the data for each channel is assembled internally. A few examples of how the interface maps for different configurations follow. For more information on how a particular configuration is mapped, see the Channelizer Mode Pin Mapping for CMOS and LVDS section.

### Example 1

For a CMOS interface with a 32-bit bus width, 8-bit data width, real data format, and four channels enabled, the data in Table 58 is expected on the input port after data is requested.

**Table 58. CMOS Pin Mapping for Bus Width = 32 Bits, Data Width = 8 Bits, Data Format = Real, Four Channels<sup>1</sup>**

DCO	D[31:24]	D[23:16]	D[15:8]	D[7:0]
1	R3	R2	R1	R0

<sup>1</sup> R represents the real data loaded to a given channel; the channel number follows R.

### Example 2

For a CMOS interface with a 32-bit bus width, 8-bit data width, complex data format, and four channels enabled, the data in Table 59 is expected on the input port after data is requested.

**Table 59. CMOS Pin Mapping for Bus Width = 32 Bits, Data Width = 8 Bits, Data Format = Complex, Four Channels<sup>1</sup>**

DCO	D[31:24]	D[23:16]	D[15:8]	D[7:0]
1	Q1	I1	Q0	I0
2	Q3	I3	Q2	I2

<sup>1</sup> I represents the in-phase term and Q represents the quadrature term of the complex data loaded to a given channel; the channel number follows I or Q.

### Example 3

For an LVDS interface with a 16-bit bus width, 8-bit data width, complex data format, and four channels enabled, the data in Table 60 is expected on the input port after data is requested.

**Table 60. LVDS Pin Mapping for Bus Width = 16 Bits, Data Width = 8 Bits, Data Format = Complex, Four Channels<sup>1</sup>**

DCO	D[15:8]P, D[15:8]N	D[7:0]P, D[7:0]N
1	Q0	I0
2	Q1	I1
3	Q2	I2
4	Q3	I3

<sup>1</sup> I represents the in-phase term and Q represents the quadrature term of the complex data loaded to a given channel; the channel number follows I or Q.

### Example 4

For an LVDS interface with a 32-bit bus width, 8-bit data width, complex data format, and four channels enabled, the data in Table 61 is expected on the input port after data is requested.

**Table 61. LVDS Pin Mapping for Bus Width = 32 Bits, Data Width = 8 Bits, Data Format = Complex, Four Channels<sup>1</sup>**

DCO <sup>2</sup>	D[15:8]P, D[15:8]N	D[7:0]P, D[7:0]N
1 rise	Q0	I0
1 fall	Q1	I1
2 rise	Q2	I2
2 fall	Q3	I3

<sup>1</sup> I represents the in-phase term and Q represents the quadrature term of the complex data loaded to a given channel; the channel number follows I or Q.

<sup>2</sup> "Rise" means that the data is sourced on the rising edge of DCOx; "fall" means that the data is sourced on the falling edge of DCOx.

### DCO and FS Rates in Channelizer Mode

The DCO signal is a data clock output provided to clock data from the digital data source. The DCO is a divided version of the DAC clock. The FS signal is an output provided to request a new data-word. The average frequency of the FS signal ( $f_{FS}$ ) is exactly equal to the symbol rate or baud rate ( $f_{BAUD}$ ) of the data. FS is intended as a request line; timing should be taken from the DCO. The frequencies of the DCO signal ( $f_{DCO}$ ), the baud rate ( $f_{BAUD}$ ), and the DAC clock ( $f_{DAC}$ ) are related as shown by the following two equations:

$$f_{DAC} = I \times \frac{P}{Q} \times 16 \times f_{BAUD} \quad (1)$$

$$f_{DCO} = f_{DAC} / (16 \times N) \quad (2)$$

where:

$I$  is the interpolation factor, which can range from 1 to 64.

$P/Q$  is the rate conversion factor (0.5 to 1.0, inclusive).

$N$  is a programmable DCO divide factor set using the DCODIV[2:0] bits in Register 0x22[6:4].

Set DCODIV[2:0] to 1, 2, or 4. A value of 0 disables the DCO. A DCODIV value of 3 is not functional. The frequency of the DSC signal is always equal to DCO.

[查询"AD9789"供应商](#)

Before choosing an interface configuration, divide the frequency of DCO by the highest frequency baud rate that will be used in the system and truncate it. The result is the number of available DCO cycles ( $cycles_{AVAIL}$ ) between FS pulses.

$$cycles_{AVAIL} = \text{floor}\left(\frac{f_{DCO}}{\max f_{BAUD}}\right)$$

Each interface configuration requires a particular number of DCO cycles between FS pulses to successfully load data into all channels. This number can be calculated using the following formula:

$$cycles_{INTERFACE} = N \times F \times \frac{DW}{BW}$$

where:

N is the number of channels enabled (1 to 4). N is always equal to 4 if channel prioritization is set to 1 (see the Channel Prioritization section).

F represents the data format. If the data format is real, F = 1; if the data format is complex, F = 2.

DW is the data width in number of bits (8 or 16).

BW is the bus width in number of bits (4, 8, 16, or 32).

For a successful interface design, the number of DCO cycles between FS pulses must be greater than the number of DCO cycles required by the interface.

**Design Example**

In this example, a system has the baud rate  $f_{FS} = 6.4$  MHz. If a 4-bit-wide interface is desired for four channels with real data format and a data width of 8 bits, the selected  $f_{DCO}$  should be at least  $8 \times f_{FS}$ . First, using Equation 1 and Equation 2, evaluate the interface speed with  $N = 1$ ,  $P/Q = 0.7$ , and  $I = 32$ .

$$f_{DAC} = 32 \times 0.7 \times 16 \times 6.4 \text{ MHz} = 2293.76 \text{ MHz}$$

$$f_{DCO} = 2293.76 \text{ MHz} / (16 \times 1) = 143.36 \text{ MHz}$$

The  $f_{DCO}/f_{BAUD}$  ratio = 22.4. If a value of  $N = 2$  is selected, the number of available DCO cycles is reduced to 11; this option may not be feasible when the latency values are taken into account. See the Latency Effects on Channelizer Mode section for more information about latency.

**Channel Prioritization**

When channels are enabled and disabled, the input interface mapping can be affected. If channel prioritization (Register 0x20[2]) is set to 0, the device expects input samples for only the channels that are enabled. In this configuration, the physical channel mapping at the DUT input can move around based on the number of channels enabled, where Channel 0 has highest priority (it never moves location when enabled). If channel prioritization is set to 1, data is expected for all four channels but the data is ignored internally if the channel is disabled.

This method is recommended because enabling and disabling channels does not shift the input data bus.

If the number of channels enabled is always less than four and the user does not plan to enable and disable channels dynamically, setting channel prioritization to 0 is the best choice because fewer clocks and/or pins are required to transfer the input data.

An example of channel prioritization set to 0 is shown in Table 62. In this example, the data interface is configured for CMOS with 32-bit bus width, 8-bit data width, and real data format.

**Table 62. Input Mapping vs. Enabled Channels, Channel Prioritization = 0**

Channels	CMOS Bit Mapping			
	[D31:D24]	[D23:D16]	[D15:D8]	[D7:D0]
4 Channels Enabled	Channel 3	Channel 2	Channel 1	Channel 0
Channel 0 Disabled		Channel 3	Channel 2	Channel 1
Channel 0, Channel 2 Disabled			Channel 3	Channel 1

The same example behaves differently when channel prioritization is set to 1, as shown in Table 63.

**Table 63. Input Mapping vs. Enabled Channels, Channel Prioritization = 1**

Channels	CMOS Bit Mapping			
	[D31:D24]	[D23:D16]	[D15:D8]	[D7:D0]
4 Channels Enabled	Channel 3	Channel 2	Channel 1	Channel 0
Channel 0 Disabled	Channel 3	Channel 2	Channel 1	
Channel 0, Channel 2 Disabled	Channel 3		Channel 1	

**Quadrature Digital Upconverter (QDUC) Mode**

In QDUC mode (Register 0x20[3] = 1), the data interface is fixed at a 32-bit bus width, 16-bit data width, and complex data format. In QDUC mode, only one channel should be enabled. If more than one channel is enabled, identical I and Q data is sent to each enabled channel. Within the datapath, the QAM mapper and the SRRC filter must be bypassed (Register 0x06[7:6] = 11).

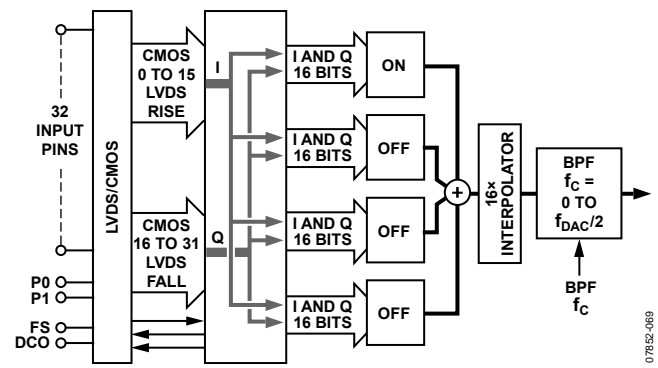

Figure 93. QDUC Mode

Pin Mapping in QDUC Mode

In CMOS mode, the AD9789 input pins are mapped as shown in Table 64.

Table 64. Pin Mapping in QDUC Mode for CMOS Interface

Data Bit	Description	Pin No.
D31	MSB of I data	L5
D16	LSB of I data	P8
D15	MSB of Q data	L9
D0	LSB of Q data	P12
P1	Parity for D[31:16]	L4
P0	Parity for D[15:0]	M4

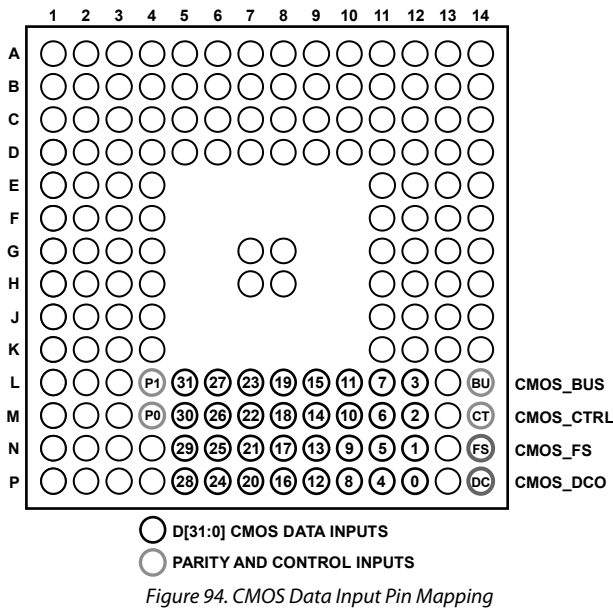

Figure 94. CMOS Data Input Pin Mapping

In LVDS mode, the AD9789 input pins are mapped as shown in Table 65.

Table 65. Pin Mapping in QDUC Mode for LVDS Interface<sup>1</sup>

Data Bit	Description	Pin No.
D15P, D15N rising	MSB of I data	L5, M5
D0P, D0N rising	LSB of I data	N12, P12
D15P, D15N falling	MSB of Q data	L5, M5
D0P, D0N falling	LSB of Q data	N12, P12
PARP, PARN rising	Parity for D[15:0]P, D[15:0]N rising	L4, M4
PARP, PARN falling	Parity for D[15:0]P, D[15:0]N falling	L4, M4

<sup>1</sup> "Rising" means that the data is sourced on the rising edge of DCOx; "falling" means that the data is sourced on the falling edge of DCOx.

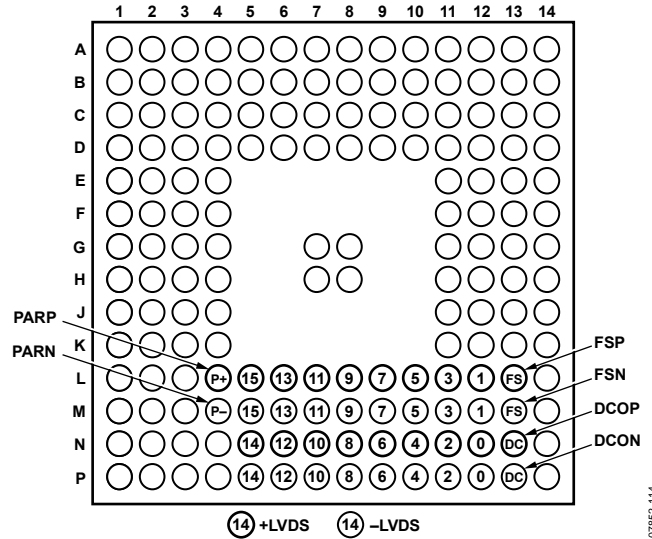

Figure 95. LVDS Data Input Pin Mapping

DCO and FS Rates in QDUC Mode

In QDUC mode, DCODIV should always be set to 1 (Register 0x22[6:4] = 001). The clock period of DCO is equal to 16 DAC clock periods. When only 16x interpolation is required and the rate converter is not used, the data rate of the interface is equal to  $f_{DCO}$ .

If further interpolation or rate conversion is enabled in the datapath, the data rate of the interface is  $f_{BAUD}$ . The average rate of FS,  $f_{FS}$ , is equal to the baud rate,  $f_{BAUD}$ . The baud rate can be specified by the following equation:

$$f_{BAUD} = \frac{f_{DCO}}{2^N \times \frac{P}{Q}}$$

where:

$N$  is the number of 2x interpolation filters enabled.

$P/Q$  is the rate converter ratio.

The FS signal becomes a request for data that effectively gates the DCO clock and ensures that data is sent at the correct baud rate. If  $P/Q = 1$  and  $N = 0$ , DCO occurs at the baud rate and FS is not required. In this case, FS is inactive (always high). The DCO signal can be used as a constant rate clock to request samples from the data source.



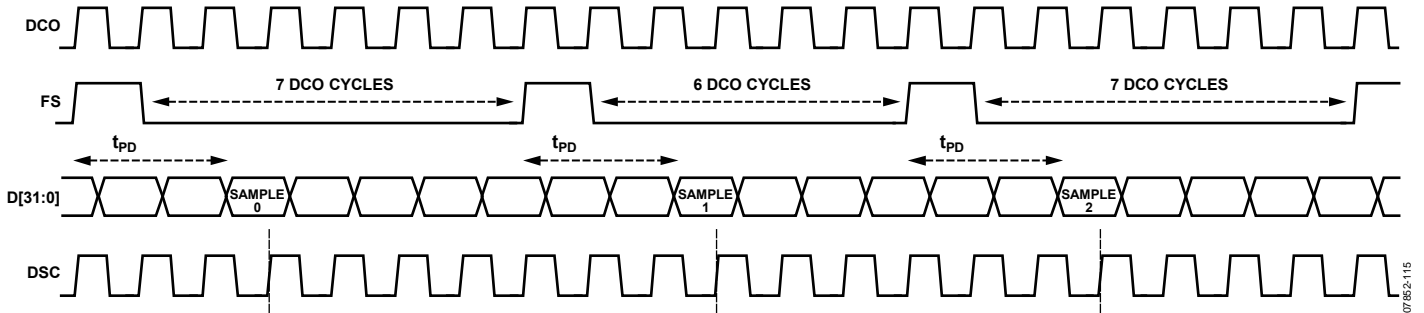

Figure 96. QDUC Mode Interface Timing Diagram for Design Example When FS Is Active

**Design Example**

In this example, a system has a DAC rate of 1600 MHz and a baud rate of 15 MHz. Because  $f_{DCO} = f_{DAC}/16 = 100$  MHz, the ratio of  $f_{DCO}/f_{FS} = 6.667$ . To satisfy the requirement that P/Q be between 0.5 and 1.0, an additional interpolation factor of  $8 \times$  must be applied, so  $N = 3$ . Solving for P/Q results in 5/6.

Therefore, three out of every 20 DCO clock edges should result in data samples being loaded into the device (the ratio of  $f_{FS}/f_{DCO} = 3/20$ ). Figure 96 shows a timing diagram that illustrates the operation of the interface in this example. In the timing diagram,  $t_{PD}$  corresponds to the propagation delay between the rising edge of FS and when the first sample in a given transmission is sampled into the AD9789. Note that  $t_{PD}$  can vary by more than 1 DCO cycle.

**Retimer Operation**

The AD9789 uses a three-register retimer. The first two registers are clocked from any one of 16 phases derived from the DAC clock. The clock for the last register is fixed to Phase 15. The programmable register clocks are the digital sample clock (DSC) and the synchronizer clock (SNC). By choosing different phases, fine adjustment of the sampling time can be made to adjust for delays in the data source. Register 0x23[7:4] sets the DSC phase (DSCPHZ) and Register 0x23[3:0] sets the SNC phase (SNCPHZ) to any one of the 16 phases. The last register in the chain is always clocked from Phase 15.

The parity counters can aid in identifying the edges of the data valid windows. Operation in CMOS mode is quite similar to operation in LVDS mode, as can be seen in Figure 97 and Figure 98.

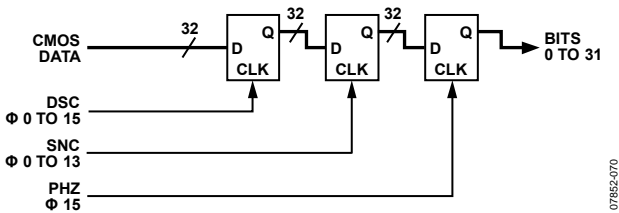

Figure 97. CMOS Retiming Registers

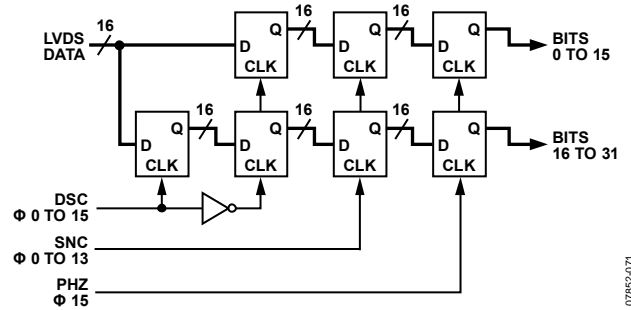

Figure 98. LVDS Rearranges the DSC Register

Register 0x23 and Register 0x21[2:0] can provide timing adjustments with very low jitter penalty, but they can also be set to the following recommended safe values:

- In LVDS mode, DSCPHZ = 0, SNCPHZ = 3, LTNCY = 0 (see the Latency Register section)
- In CMOS mode, DSCPHZ = 0, SNCPHZ = 7, LTNCY = 0 (see the Latency Register section)

Timing adjustments can then be made in an FPGA or other data source.

Note that selecting Phase 14 or Phase 15 for SNCPHZ results in a timing violation. In CMOS mode, setting DSCPHZ one step behind or at SNCPHZ also results in a timing violation.

**Latency Register**

A latency register, controlled via Register 0x21[2:0], follows the three-register retimer and can delay the data up to seven DCO clocks in steps of one DCO clock. The critical retiming is already done in the first three registers, so an incorrect latency value does not result in a timing violation. The latency value determines which data sample is the first sample in a transmission and routes that sample to the appropriate channel. Latency is affected by the round-trip delay from when FS goes high to when the first data sample is output from the retimer. If the latency value programmed into the part is incorrect, the input data samples will not be assembled properly.

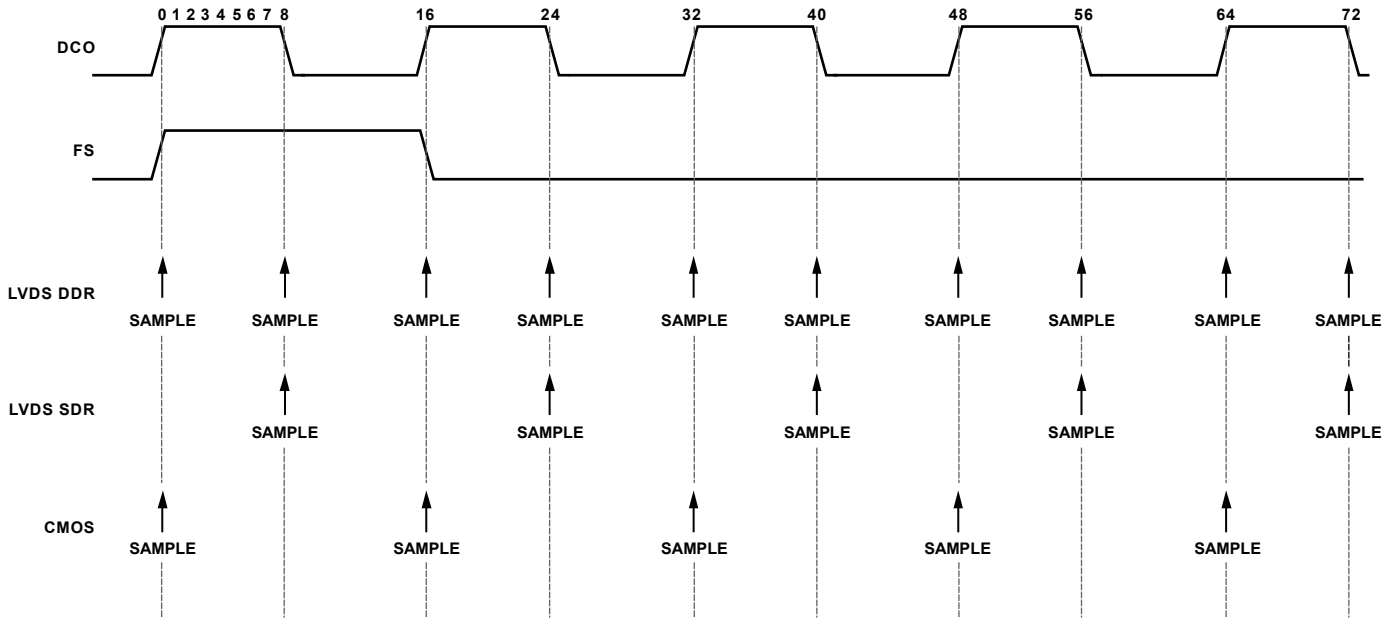

Figure 99. Sampling Points at Delay = 0

07852-116

### Retimer and Latency Look-Up Tables

In practice, the retimer and latency parameters can be reduced to a single verified and guaranteed table that provides delays at optimum sample points from 0 to over 100 DAC clocks. The sampling points for LVDS DDR, LVDS SDR, and CMOS interface modes are given in Figure 99 for delay = 0. The number scale above the DCO signal in Figure 99 corresponds to the delay value in DAC clock cycles in Table 66 and Table 67.

The delay of the pins should be taken into account. This delay is 800 ps for the output delay and 800 ps for the input delay, for a total of 1.6 ns. This means that the true 0 delay between DCO and the center of the data valid window occurs at Delay Setting 4 in Table 66 for a 2.4 GHz DAC clock; for a 1.2 GHz DAC clock, the true 0 delay occurs at Delay Setting 2.

To use Table 66 and Table 67, probe the FS, DCO, and data input signals at the AD9789. While viewing these signals on an oscilloscope, measure the delay between the rising edge of FS and the start of the first data sample and add 1.6 ns from the delay of the pins to this value. Normalize this total delay to one DAC clock period. The optimum sampling point in number of DAC clock cycles, which corresponds to the delay number in Table 66 and Table 67, can be found from this measured value for each interface mode.

For LVDS DDR,

$$Delay_{OPTIMAL} = \frac{Delay_{MEASURED} + 1.6 \text{ ns}}{t_{DCO} / 16} + 16$$

For LVDS SDR,

$$Delay_{OPTIMAL} = \frac{Delay_{MEASURED} + 1.6 \text{ ns}}{t_{DCO} / 16} + 8$$

For CMOS,

$$Delay_{OPTIMAL} = \frac{Delay_{MEASURED} + 1.6 \text{ ns}}{t_{DCO} / 16} + 8$$

For a maximum valid sampling window, the sampling point should be fine-tuned based on the data input setup and hold times. If the setup and hold times are symmetric about the DCO edge, choosing a sampling point at the center of the data window results in the maximum valid sampling window. For more information on the input data setup and hold times, refer to the CMOS Interface Timing section or the LVDS Interface Timing section.

The LAT, SNC, and DSC values for the optimal sampling point in Table 66 or Table 67 should be written to the LTNCY[2:0] bits in Register 0x21[2:0], the SNCPHZ[3:0] bits in Register 0x23[3:0], and the DSCPHZ[3:0] bits in Register 0x23[7:4], respectively.

Table 66. Recommended Retimer Settings for All Delay Values, LVDS Mode

Delay	0	1	2	3	4	5	6	7
LAT	0	0	0	0	0	0	1	1
SNC	7	8	9	9	10	10	2	3
DSC	8	9	10	11	12	13	14	15
Delay	8	9	10	11	12	13	14	15
LAT	1	1	1	1	1	1	1	1
SNC	3	4	4	5	5	6	6	7
DSC	0	1	2	3	4	5	6	7
Delay	16	17	18	19	20	21	22	23
LAT	1	1	1	1	1	1	2	2
SNC	7	8	9	9	10	10	2	3
DSC	8	9	10	11	12	13	14	15
Delay	24	25	26	27	28	29	30	31
LAT	2	2	2	2	2	2	2	2
SNC	3	4	4	5	5	6	6	7
DSC	0	1	2	3	4	5	6	7
Delay	32	33	34	35	36	37	38	39
LAT	2	2	2	2	2	2	3	3
SNC	7	8	9	9	10	10	2	3
DSC	8	9	10	11	12	13	14	15
Delay	40	41	42	43	44	45	46	47
LAT	3	3	3	3	3	3	3	3
SNC	3	4	4	5	5	6	6	7
DSC	0	1	2	3	4	5	6	7
Delay	48	49	50	51	52	53	54	55
LAT	3	3	3	3	3	3	4	4
SNC	7	8	9	9	10	10	2	3
DSC	8	9	10	11	12	13	14	15
Delay	56	57	58	59	60	61	62	63
LAT	4	4	4	4	4	4	4	4
SNC	3	4	4	5	5	6	6	7
DSC	0	1	2	3	4	5	6	7
Delay	64	65	66	67	68	69	70	71
LAT	4	4	4	4	4	4	5	5
SNC	7	8	9	9	10	10	2	3
DSC	8	9	10	11	12	13	14	15
Delay	72	73	74	75	76	77	78	79
LAT	5	5	5	5	5	5	5	5
SNC	3	4	4	5	5	6	6	7
DSC	0	1	2	3	4	5	6	7
Delay	80	81	82	83	84	85	86	87
LAT	5	5	5	5	5	5	6	6
SNC	7	8	9	9	10	10	2	3
DSC	8	9	10	11	12	13	14	15
Delay	88	89	90	91	92	93	94	95
LAT	6	6	6	6	6	6	6	6
SNC	3	4	4	5	5	6	6	7
DSC	0	1	2	3	4	5	6	7

Delay	96	97	98	99	100	101	102	103
LAT	6	6	6	6	6	6	7	7
SNC	7	8	9	9	10	10	2	3
DSC	8	9	10	11	12	13	14	15
Delay	104	105	106	107	108	109	110	111
LAT	7	7	7	7	7	7	7	7
SNC	3	4	4	5	5	6	6	7
DSC	0	1	2	3	4	5	6	7
Delay	112	113	114	115	116	117	X	X
LAT	7	7	7	7	7	7	X	X
SNC	7	8	9	9	10	10	X	X
DSC	8	9	10	11	12	13	X	X

Table 67. Recommended Retimer Settings for All Delay Values, CMOS Mode

Delay	0	1	2	3	4	5	6	7
LAT	0	0	0	0	0	0	1	1
SNC	7	8	8	9	9	2	2	3
DSC	0	1	2	3	4	5	6	7
Delay	8	9	10	11	12	13	14	15
LAT	1	1	1	1	1	1	1	1
SNC	3	4	4	5	5	6	6	7
DSC	8	9	10	11	12	13	14	15
Delay	16	17	18	19	20	21	22	23
LAT	1	1	1	1	1	1	2	2
SNC	7	8	8	9	9	2	2	3
DSC	0	1	2	3	4	5	6	7
Delay	24	25	26	27	28	29	30	31
LAT	2	2	2	2	2	2	2	2
SNC	3	4	4	5	5	6	6	7
DSC	8	9	10	11	12	13	14	15
Delay	32	33	34	35	36	37	38	39
LAT	2	2	2	2	2	2	3	3
SNC	7	8	8	9	9	2	2	3
DSC	0	1	2	3	4	5	6	7
Delay	40	41	42	43	44	45	46	47
LAT	3	3	3	3	3	3	3	3
SNC	3	4	4	5	5	6	6	7
DSC	8	9	10	11	12	13	14	15
Delay	48	49	50	51	52	53	54	55
LAT	3	3	3	3	3	3	4	4
SNC	7	8	8	9	9	2	2	3
DSC	0	1	2	3	4	5	6	7
Delay	56	57	58	59	60	61	62	63
LAT	4	4	4	4	4	4	4	4
SNC	3	4	4	5	5	6	6	7
DSC	8	9	10	11	12	13	14	15
Delay	64	65	66	67	68	69	70	71
LAT	4	4	4	4	4	4	5	5
SNC	7	8	8	9	9	2	2	3
DSC	0	1	2	3	4	5	6	7

<b>Delay</b>	<b>72</b>	<b>73</b>	<b>74</b>	<b>75</b>	<b>76</b>	<b>77</b>	<b>78</b>	<b>79</b>
LAT	5	5	5	5	5	5	5	5
SNC	3	4	4	5	5	6	6	7
DSC	8	9	10	11	12	13	14	15
<b>Delay</b>	<b>80</b>	<b>81</b>	<b>82</b>	<b>83</b>	<b>84</b>	<b>85</b>	<b>86</b>	<b>87</b>
LAT	5	5	5	5	5	5	6	6
SNC	7	8	8	9	9	2	2	3
DSC	0	1	2	3	4	5	6	7
<b>Delay</b>	<b>88</b>	<b>89</b>	<b>90</b>	<b>91</b>	<b>92</b>	<b>93</b>	<b>94</b>	<b>95</b>
LAT	6	6	6	6	6	6	6	6
SNC	3	4	4	5	5	6	6	7
DSC	8	9	10	11	12	13	14	15
<b>Delay</b>	<b>96</b>	<b>97</b>	<b>98</b>	<b>99</b>	<b>100</b>	<b>101</b>	<b>102</b>	<b>103</b>
LAT	6	6	6	6	6	6	7	7
SNC	7	8	8	9	9	2	2	3
DSC	0	1	2	3	4	5	6	7
<b>Delay</b>	<b>104</b>	<b>105</b>	<b>106</b>	<b>107</b>	<b>108</b>	<b>109</b>	<b>110</b>	<b>111</b>
LAT	7	7	7	7	7	7	7	7
SNC	3	4	4	5	5	6	6	7
DSC	8	9	10	11	12	13	14	15
<b>Delay</b>	<b>112</b>	<b>113</b>	<b>114</b>	<b>115</b>	<b>116</b>	<b>117</b>	<b>X</b>	<b>X</b>
LAT	7	7	7	7	7	7	X	X
SNC	7	8	8	9	9	2	X	X
DSC	0	1	2	3	4	5	X	X

**Latency Effects on Channelizer Mode**

When selecting an interface configuration in channelizer mode, the number of DCO cycles between FS pulses ( $cycles_{AVAIL}$ ) must be greater than the number of DCO cycles required by the interface configuration ( $cycles_{INTERFACE}$ ). Latency consumes some of these available DCO cycles between FS. This decrease in available DCO cycles is a result of the round-trip propagation delay from the FS output of the AD9789 to the respective data sample at the input of the AD9789 (LTNCY[2:0]) in addition to the internal latency of the device.

For a successful interface design, the following condition must be met:

$$cycles_{AVAIL} \geq cycles_{INTERFACE} + LTNCY[2:0] + 2$$

**CMOS Interface Timing**

When the AD9789 is configured with a CMOS interface (CMOS\_CTRL = CMOS\_BUS = 3.3 V), a CMOS data clock output signal, DCO, is provided to drive data from the data source. The output signal operates at the input data rate, which is equal to  $f_{DAC}/16$  when DCODIV = 1. CMOS data on the bus is sampled on the rising edge of an internal sampling clock (DSC). Note that the frequency of DCO is equal to the frequency of DSC and the phase relationship between DCO and DSC is determined by DSCPHZ (Register 0x23[7:4]).

The timing of the input data is referenced to DCO for a given phase of DSC. The CMOS data input timing over temperature is shown in Table 68 for DCO\_INV = 0 (Register 0x20[4]), DSCPHZ = 0 (Register 0x23[7:4]), and DCODIV = 1 (Register 0x22[6:4]). Table 68 also shows the data valid window (DVW). The data valid window is the sum of the setup and hold times of the interface. DVW is the minimum amount of time that valid data must be presented to the device to ensure proper sampling.

**Table 68. CMOS Data Input Timing with Respect to DCO**

Temperature	Min $t_s$ (ns)	Min $t_H$ (ns)	Min DVW (ns)
-40°C	4.9	-1.4	3.5
+25°C	5.1	-1.6	3.5
+85°C	5.3	-1.7	3.6
-40°C to +85°C	5.3	-1.4	3.9

For any value of DSCPHZ greater than 0, the setup and hold times shift by increments of  $t_{DCO}/16$ , where  $t_{DCO}$  is the period of the data clock.

$$t_s = 5.3 \text{ ns} - ((t_{DCO}/16) \times DSCPHZ)$$

$$t_H = 0.24 \text{ ns} + ((t_{DCO}/16) \times DSCPHZ)$$

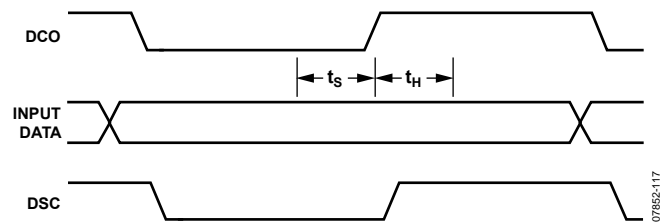

Figure 100. CMOS Input Timing

In some interface modes, the delay from the rising edge of DCO to the rising edge of FS needs to be known. This delay is summarized over temperature in Table 69.

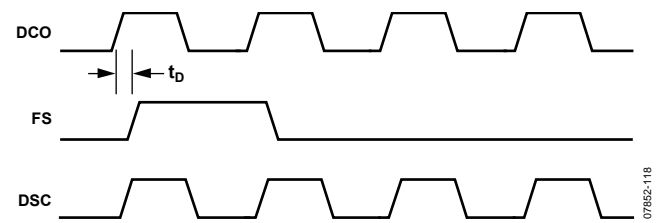

Figure 101. CMOS\_DCO to CMOS\_FS Delay

**Table 69. Timing Delay Between CMOS\_DCO and CMOS\_FS**

Temperature	$t_{D, MAX}$ DCO to FS (ns)	$t_{D, MIN}$ DCO to FS (ns)
-40°C	0.64	0.28
+25°C	0.71	0.4
+85°C	0.85	0.49
-40°C to +85°C	0.85	0.28

**LVDS Interface Timing**

When the AD9789 is configured with an LVDS interface (CMOS\_CTRL = CMOS\_BUS = 0 V), an LVDS data clock output signal, DCO, is provided to drive data from the data source. The LVDS interface may be single data rate (SDR) or double data rate (DDR) depending on the bus width configuration. In SDR, data is sampled into the part only on the falling edge of the internal sampling clock (DSC). Note that the frequency of DCO is equal to the frequency of DSC, so the effective data rate is equal to the DCO frequency. The phase relationship between DCO and DSC is determined by DSCPHZ (Register 0x23[7:4]). In DDR, data is sampled into the part on both the rising and falling edges of DSC, so the effective data rate is equal to twice the DCO frequency. The interface is DDR only when the bus width is equal to 32 bits. The DCO frequency is equal to  $f_{DAC}/16$  when DCODIV = 1.

The timing of the input data is referenced to DCO for a given phase of DSC. The LVDS input data timing over temperature is shown in Table 70 for DCO\_INV = 0 (Register 0x20[4]), DSCPHZ = 0 (Register 0x23[7:4]), and DCODIV = 1 (Register 0x22[6:4]).

**Table 70. LVDS Data Input Timing with Respect to DCO**

Temperature	Min $t_s$ (ns)	Min $t_H$ (ns)	Min DVW (ns)
-40°C	1.04	0.24	1.28
+25°C	1.23	0.16	1.39
+85°C	1.41	0.03	1.44
-40°C to +85°C	1.41	0.24	1.65

In DDR mode, these setup and hold times must be applied to both edges of DCO. In SDR mode, these setup and hold times must be applied to the falling edge of DCO.

For any value of DSCPHZ greater than 0, the setup and hold times shift by increments of  $t_{DCO}/16$ , where  $t_{DCO}$  is the period of the data clock.

$$t_s = 1.41 \text{ ns} - ((t_{DCO}/16) \times DSCPHZ)$$

$$t_H = 0.24 \text{ ns} + ((t_{DCO}/16) \times DSCPHZ)$$

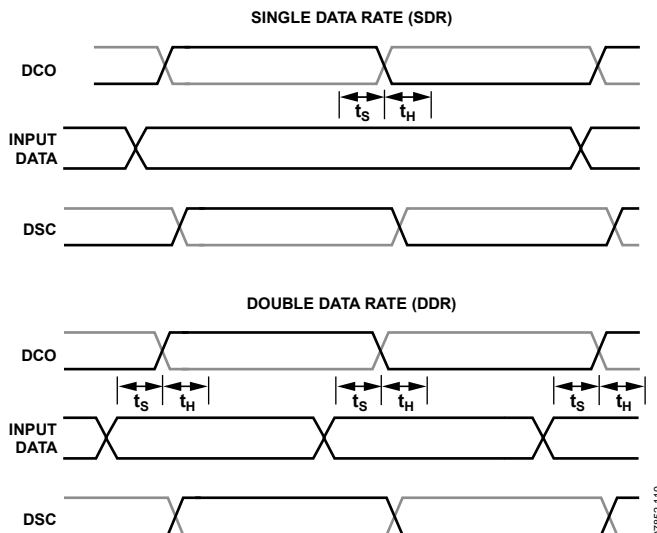

Figure 102. LVDS Input Timing, SDR vs. DDR

In some interface modes, the delay from the rising edge of DCO to the rising edge of FS needs to be known. This delay is summarized over temperature in Table 71.

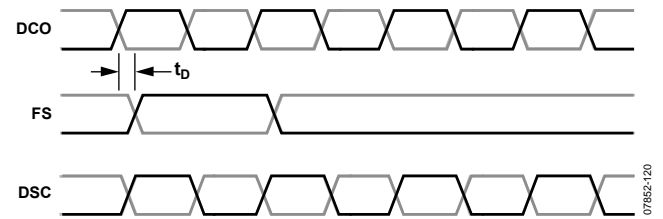

Figure 103. LVDS DCO to FS Delay

**Table 71. Timing Delay Between LVDS DCO and FS**

Temperature	$t_{d, \text{MAX}}$ DCO to FS (ns)	$t_{d, \text{MIN}}$ DCO to FS (ns)
-40°C	0.37	0.21
+25°C	0.35	0.16
+85°C	0.32	0.12
-40°C to +85°C	0.37	0.12

**Parity**

The AD9789 supports parity checking on the input data bus. There are three parity checking modes: even parity, odd parity, and IQ parity. In IQ parity mode, a value of 0 is always expected on the I channel and a value of 1 is always expected on the Q channel. Note that IQ parity mode is generally useful only when the LVDS interface is used. These modes are controlled via Register 0x20[1:0].

**Table 72. Parity Mode SPI Settings**

Parity Mode	Register 0x20[1:0]
Deactivates Parity Checking	00
IQ Parity	01
Even Parity	10
Odd Parity	11

If parity checking is used, each data-word that is transferred into the AD9789 should have a parity bit accompanying it, regardless of FS. In other words, parity must be valid for every DCO edge. The parity bits are located at Pin L4 and Pin M4. When operating the interface in CMOS mode, the input parity bits are referred to as P1 and P0, respectively. When operating the interface in LVDS mode, the input parity bits are referred to as PARN and PARP, respectively.

Recall that the LVDS interface can be single data rate (SDR) or double data rate (DDR), depending on the bus width configuration. The interface is DDR only when the bus width is equal to 32 bits.

In QDUC mode, where the interface is fixed at a 32-bit bus width, the parity behavior is straightforward (see Table 73).

**Table 73. Parity Behavior in QDUC Mode**

Interface	Bus Width	Even/Odd Parity	IQ Parity
CMOS	32 bits	P1 checks D[31:16] P0 checks D[15:0]	P1 = 0 P0 = 1
LVDS <sup>1</sup> (DDR)	32 bits	[PARP, PARN] rising checks D[15:0]P, D[15:0]N rising [PARP, PARN] falling checks D[15:0]P, D[15:0]N falling	PARP rising = 0 PARN rising = 1 PARP falling = 1 PARN falling = 0

<sup>1</sup> "Rising" corresponds to the data sampled on the rising edge of DSC; "falling" corresponds to the data sampled on the falling edge of DSC.

In channelizer mode, where the interface is configurable for different bus widths, data widths, and data formats, the parity bits check the data-word on the bus.

For example, consider a configuration in channelizer mode where the bus width is 4, the data width is 8, and the data format is real. In this case, eight clock cycles are required to transfer all of the baud rate data to represent four channels. In the even parity or odd parity mode, one parity bit and four data bits are sent on each clock; the parity bit checks the four data bits to verify that all of the data was sent over the interface.

Table 74 summarizes the behavior of the two parity pins and how they interact with the data in all interface modes.

**Table 74. Parity Behavior in Channelizer Mode**

Interface	Bus Width	Even/Odd Parity	IQ Parity
CMOS	4 bits	P1 ignored P0 checks D[3:0]	P1 = 0 P0 = 1
CMOS	8 bits	P1 ignored P0 checks D[7:0]	P1 = 0 P0 = 1
CMOS	16 bits	P1 ignored P0 checks D[15:0]	P1 = 0 P0 = 1
CMOS	32 bits	P1 checks D[31:16] P0 checks D[15:0]	P1 = 0 P0 = 1
LVDS (SDR) <sup>1</sup>	4 bits	[PARP, PARN] falling checks D[3:0]P, D[3:0]N falling	Not supported
LVDS (SDR) <sup>1</sup>	8 bits	[PARP, PARN] falling checks D[7:0]P, D[7:0]N falling	Not supported
LVDS (SDR) <sup>1</sup>	16 bits	[PARP, PARN] falling checks D[15:0]P, D[15:0]N falling	Not supported
LVDS (DDR) <sup>1</sup>	32 bits	[PARP, PARN] rising checks D[15:0]P, D[15:0]N rising [PARP, PARN] falling checks D[15:0]P, D[15:0]N falling	PARP rising = 0 PARN rising = 1 PARP falling = 1 PARN falling = 0

<sup>1</sup> "Rising" corresponds to the data sampled on the rising edge of DSC; "falling" corresponds to the data sampled on the falling edge of DSC.

If a parity error occurs, the parity counter (Register 0x02[7:0]) is incremented. The parity counter continues to accumulate until it is cleared or until it reaches a maximum value of 255. The count can be cleared by writing a 1 to Register 0x04[7].

An IRQ can be enabled to trigger when a parity error occurs by writing a 1 to Register 0x03[7]. The status of IRQ can be measured via Register 0x04[7] or by using the IRQ pin (Pin P2). If using the IRQ pin and more than one IRQ is enabled, the user must check Register 0x04 when an IRQ event occurs to determine whether the IRQ was caused by a parity error. The IRQ can also be cleared by writing a 1 to Register 0x04[7].

**ANALOG MODES OF OPERATION**

The AD9789 uses a quad-switch architecture that can be configured to operate in one of three modes via the serial peripheral interface: normal mode, RZ mode, and mix mode.

The quad-switch architecture masks the code-dependent glitches that occur in a conventional two-switch DAC. Figure 104 shows the waveforms for a conventional DAC and the quad-switch DAC. In the two-switch architecture with D1 and D2 in different states, a switch transition results in a glitch. However, if D1 and D2 are at the same state, the switch does not create a glitch. This code-dependent glitching causes an increased amount of distortion in the DAC. In the quad-switch architecture, two switches are always transitioning at each half clock cycle, regardless of the code; therefore, code-dependent glitches are eliminated, but a constant glitch at  $2 \times f_{DAC}$  is created.

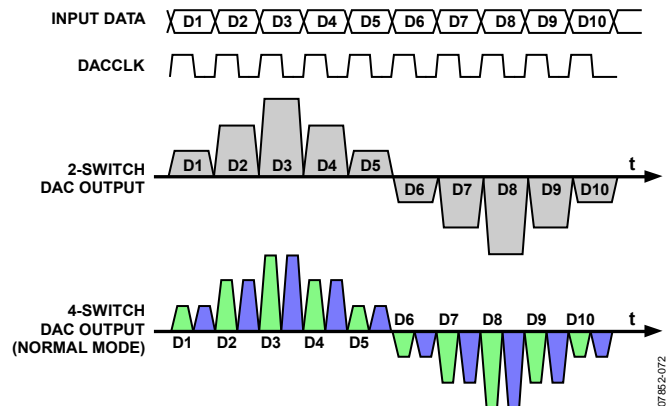

Figure 104. Two-Switch and Quad-Switch DAC Waveforms

The quad-switch architecture can also be easily configured to perform an analog mix or return-to-zero (RZ) function. In mix mode, the output is effectively chopped at the DAC sample rate.

The RZ mode is similar to mix mode, except that the intermediate data samples are replaced with midscale values instead of inverting values. Figure 105 shows the DAC waveforms for both mix mode and RZ mode.

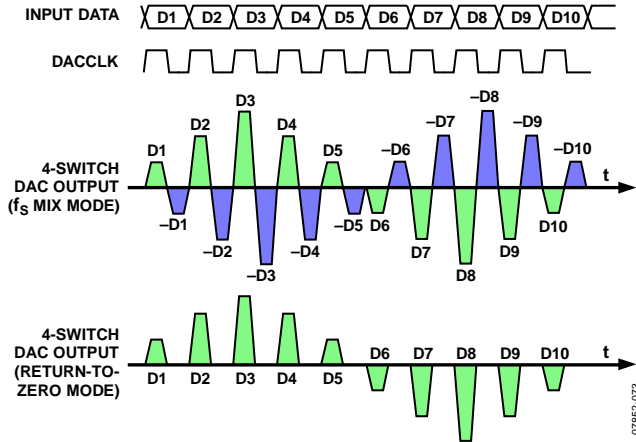

Figure 105. Mix Mode and RZ Mode DAC Waveforms

Switching between analog modes reshapes the sinc roll-off inherent at the DAC output. The performance and maximum amplitude in all three Nyquist zones is affected by this sinc roll-off depending on where the carrier is placed, as shown in Figure 106.

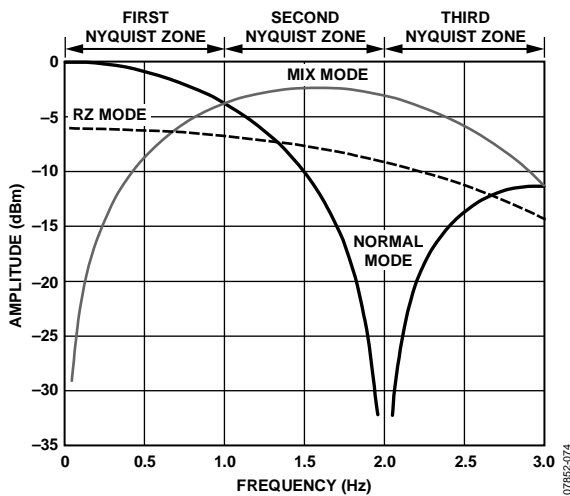

Figure 106. Sinc Roll-Off for Each Analog Operating Mode ( $f_s = 2 \times \text{DACCLK}$ )

The RZ mode, with its lower but flat response, can be quite useful for quick checks of system frequency response.

### ANALOG CONTROL REGISTERS

The AD9789 includes registers for optimizing its analog performance. These registers include noise reduction in the output current mirror and output current mirror headroom adjustments.

#### Mirror Roll-Off Frequency Control

Using the MSEL[1:0] bits (Register 0x36[1:0]), the user can adjust the noise contribution of the internal current mirror to optimize the 1/f noise. Figure 107 shows MSEL vs. the 1/f noise with 20 mA full-scale current into a 50 Ω resistor.

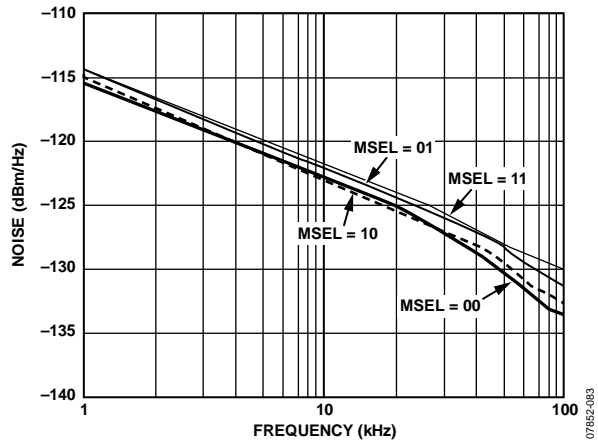

Figure 107. 1/f Noise with Respect to MSEL Bits

**VOLTAGE REFERENCE**

The AD9789 output current is set by a combination of digital control bits and the I120 reference current, as shown in Figure 108.

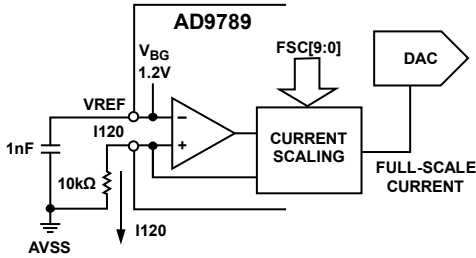

Figure 108. Voltage Reference Circuit

The reference current is obtained by forcing the band gap voltage across an external 10 kΩ resistor from I120 (Pin B14) to ground. The 1.2 V nominal band gap voltage, VREF (Pin C14), generates a 120 μA reference current in the 10 kΩ resistor. This current is adjusted digitally by FSC[7:0] (Register 0x3C[7:0]) and FSC[9:8] (Register 0x3D[1:0]) to set the output full-scale current, I<sub>FS</sub>, in milliamperes.

$$I_{FS} = 0.023 \times FSC[9:0] + 8.58$$

The full-scale output current range is approximately 8.6 mA to 32.1 mA for register values from 0x000 to 0x3FF. The default value of 0x200 generates 20 mA full scale. The typical range is shown in Figure 109.

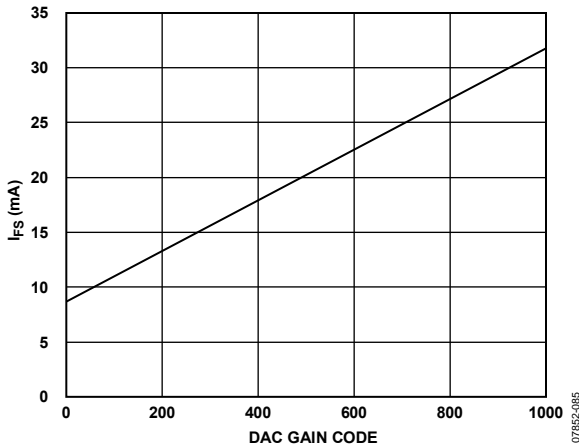

Figure 109. Full-Scale Current vs. DAC Gain Code

Always connect a 10 kΩ resistor from the I120 pin to ground and use the digital controls to adjust the full-scale current. The AD9789 is not a multiplying DAC. Applying an analog signal to I120 is not supported.

VREF (Pin C14) must be bypassed to ground with a 1 nF capacitor. The band gap voltage is present on this pin and can be buffered for use in external circuitry. The typical output impedance is near 5 kΩ. If desired, an external reference can be used to overdrive the internal reference by connecting it to the VREF pin.

IPTAT (Pin D14) is used for factory testing and can simply be left floating. IPTAT is an output current that is proportional to absolute temperature. At 25°C, the output current is approximately 10 μA and follows a slope of approximately 20 nA/°C.

For optimal DOCSIS 3.0 ACLR performance, the full-scale output current settings provided in Table 75 are recommended.

**Table 75. Recommended Full-Scale Current Settings vs. Number of QAM Channels**

Number of QAM Channels	Recommended I <sub>FS</sub> (mA)	FSC[9:0]
1	20	512
2	25	720
3	25	720
4	25	720

**DAC OUTPUT STAGES**

To properly evaluate the AD9789 in the lab, three distinct output coupling circuits were used.

Figure 110 shows the optimal output network when measuring traditional DAC performance specifications such as SFDR and IMD performance with sine waves.

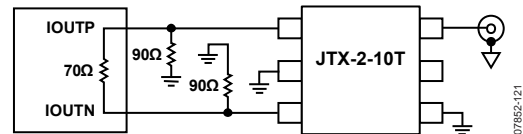

Figure 110. Recommended Transformer Output Stage for Single-Tone/Multitone Measurements

Figure 111 shows the optimal output network when measuring signals in mix mode (second or third Nyquist zone). The bandwidth of the center tap transformer is not sufficient to support mix mode outputs, so the best solution is to use a wideband balun by itself.

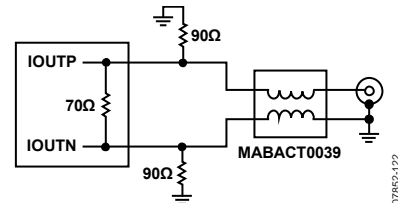

Figure 111. Recommended Transformer Output Stage for Mix Mode



Finally, when measuring performance for CMTS and other digital TV applications, it is advantageous to insert a 1 dB, 1.2 GHz Chebyshev low-pass filter between the DAC and the transformer to better control the impedance seen at the DAC core. This helps to decrease the folded back harmonics for higher frequency outputs. The optimal transformer for CMTS measurements is the JTX-2-10T, which consists of a balun and center-tapped transformer in a single package. This output stage is shown in Figure 112.

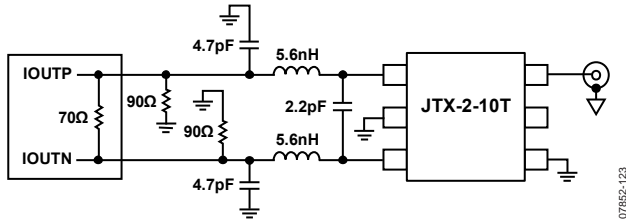

Figure 112. Recommended Transformer Output Stage for CMTS Measurements

Traces from the DAC to the transformer should be 50 Ω impedance to ground each in Figure 110 and Figure 112 and 25 Ω to ground each in Figure 111 to avoid unnecessary parasitics.

### CLOCKING THE AD9789

To provide the required signal swing for the internal clock receiver of the AD9789, it is necessary to use an external clock buffer chip to drive the CLKP and CLKN inputs. These high level, high slew rate signals should not be routed any distance on a PCB. The recommended clock buffer for this application is the ADCLK914. This ultrafast clock buffer is capable of providing 1.9 V out of each side into a 50 Ω load terminated to V<sub>CC</sub> (3.3 V) for a total differential swing of 3.8 V.

The buffer, in turn, can be easily driven from lower level signals such as CML or attenuated PECL that might be encountered on a PCB. This buffer also provides very low, 100 fs added random jitter, which is important to obtain the optimal ac performance from the AD9789. A functional block diagram of the ADCLK914 is shown in Figure 113. Figure 114 shows the recommended schematic for the ADCLK914/AD9789 interface. Refer to the ADCLK914 data sheet for more information. Any time that the noise floor from the DAC cannot meet the specifications in this data sheet, the clock should be examined.

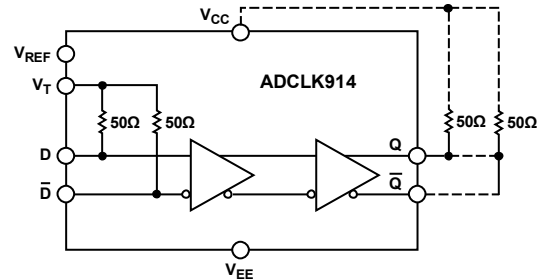

Figure 113. ADCLK914 Functional Block Diagram

The internal 50 Ω resistors shown at the ADCLK914 inputs are rated to carry currents from PECL or CML drivers. The V<sub>T</sub> pin can be connected to V<sub>CC</sub>, a PECL current sink, or the internal V<sub>REF</sub>, or it can be left floating depending on the source. The common-mode input range of the ADCLK914 does not include LVDS voltage levels, so ac coupling is required in that case.

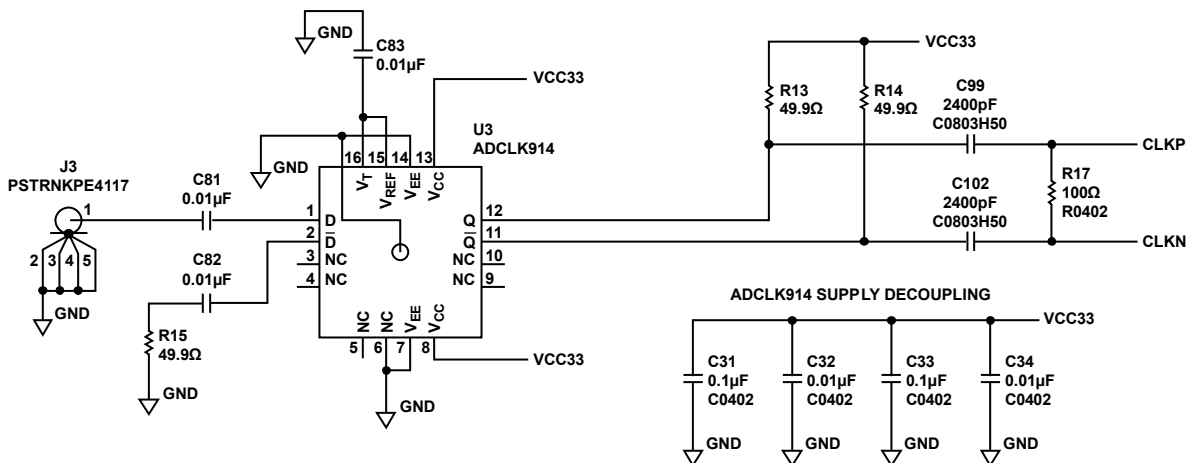

Figure 114. ADCLK914/AD9789 Interface Circuit for Use with a Lab Generator

**Optimizing the Clock Common-Mode Voltage**

In addition to the system that optimizes the handoff timing, an additional system sets the common-mode voltage of the clock. This system can be used to properly align the crossing point of the CLKP and CLKN signals to ensure that the duty cycle of the clock is set properly. Figure 115 shows how the common-mode voltage of CLKP and CLKN is set. There are eight switches controlled by the CLKP\_CML bits (Register 0x32[4:1]) and the CLKN\_CML bits (Register 0x31[7:4]) for both the CLKP and CLKN signals. The direction of the adjustment is determined by the PSIGN and NSIGN bits (Register 0x32, Bit 5 and Bit 0). If PSIGN and NSIGN are low, the common-mode voltage decreases with CLKP\_CML/CLKN\_CML values. If PSIGN and NSIGN are high, the common-mode voltage increases with CLKP\_CML/CLKN\_CML values, as shown in Figure 116. With both CLKP\_CML and CLKN\_CML set to 0, the feedback path forces the common-mode voltage to be set to approximately 0.9 V. The optimal ac performance occurs at a setting of -15 on both the CLKP and CLKN offset bits.

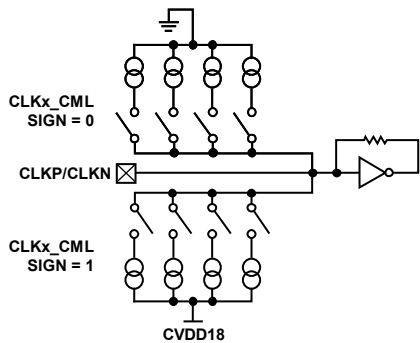

Figure 115. Clock Common-Mode Control

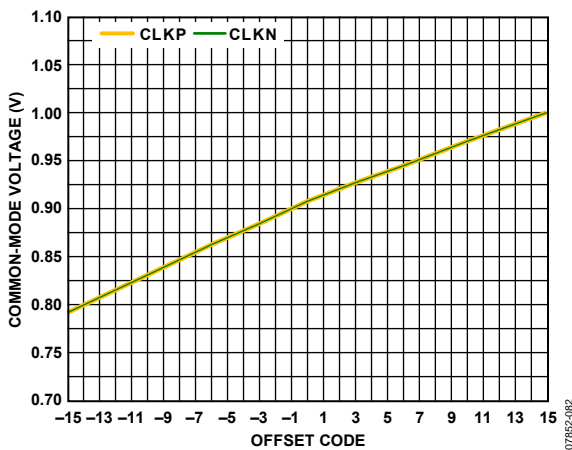

Figure 116. Common-Mode Voltage with Respect to CLKP\_CML/CLKN\_CML and PSIGN/NSIGN

**Clock Phase Noise Effects on AC Performance**

The quality of the clock source driving the ADCLK914 determines the achievable ACLR performance of the AD9789. Table 76 summarizes the close-in ACLR for a four-carrier DOCSIS signal at 900 MHz with respect to various phase noise profiles. (All ACLR values are specified in dBc.)

**Table 76. Four-Carrier DOCSIS Close-In ACLR Performance at 900 MHz for Various Phase Noise Profiles**

Band	Phase Noise (dBc)				Spec
	Profile 1	Profile 2	Profile 3	Profile 4	
750 kHz to 6 MHz	-71	-67.2	-62.4	-59.1	-60
6 MHz to 12 MHz	-70.9	-70.3	-67	-63.8	-63
12 MHz to 18 MHz	-71	-70.8	-70.8	-70.8	-65

Table 77 shows the phase noise at various offsets for each profile. (All phase noise numbers are specified in dBc/Hz.)

**Table 77. Phase Noise Summary for Each Profile**

Offset <sup>1</sup>	Phase Noise (dBc/Hz)			
	Profile 1	Profile 2	Profile 3	Profile 4
2 kHz	-114.8	-112.8	-111.7	-111.2
20 kHz	-117.8	-115.5	-114.6	-113.8
200 kHz	-128.3	-118.9	-118.3	-116.8
2 MHz	-148.5	-127.9	-122.2	-117.9
20 MHz	-152.5	-149.9	-148	-145.7

<sup>1</sup> At offsets less than 500 kHz, the measurement instrument dominates the phase noise performance.

To meet the close-in ACLR requirements for four-carrier DOCSIS, the phase noise found in Profile 3 is the minimum requirement necessary.

**MU DELAY CONTROLLER**

The mu delay adjusts timing between the digital and analog blocks. The mu delay controller receives phase relational information between the digital and analog clock domains. The control system continuously adjusts the mu delay to maintain the desired phase relationship between the digital and analog sections. A top level diagram of the mu delay within the DAC is shown in Figure 117.

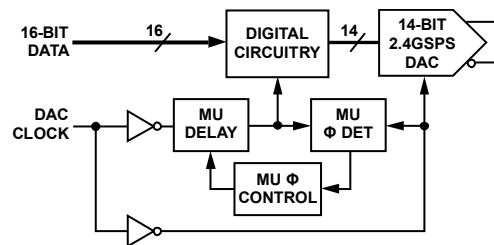

Figure 117. Mu Delay Controller Block Diagram

The mu controller has two modes of operation: initial phase search and phase tracking. In the phase search mode, the controller looks for the initial mu delay value to use before going into tracking mode. In tracking mode, the controller makes adjustments to the initial mu delay value to keep the phase at the desired value. The initial phase search is required because multiple mu delay settings may result in the desired phase, but the device may not operate correctly at all of those mu delay values.

### Operating the Mu Controller in Auto Mode

The mu controller is enabled via Register 0x33[0]. Enabling the controller sets in motion the phase search mode. Before enabling the controller, it is important to turn on both the phase comparator boost (Register 0x3E[5]) and the mu control duty cycle correction circuitry (Register 0x30[7]). Both of these functions allow for more robust operation of the mu controller over the entire operating speed of the part. The three modes of operation for the mu controller are specified by the MODE[1:0] bits in Register 0x33[5:4] as follows:

- Search and track (00) (optimal setting)
- Track only (01)
- Search only (10)

The search algorithm begins at a specified mu delay value set using the MUDLY[8:0] bits, where the LSB is located in Register 0x39[7] and the MSBs are located in Register 0x3A[7:0]. Even though there are nine bits of resolution for this delay line value, the maximum allowable mu delay is 431 (decimal). The optimal point to begin the search is in the middle of the delay line, or approximately 216. The initial search algorithm works by sweeping through different mu delay values until the desired phase is measured; this phase is specified using the MUPHZ[4:0] bits in Register 0x39[4:0], with the maximum allowable phase being 16. If values larger than 16 are loaded, the controller will not lock. When the desired phase is measured, the slope of the phase measurement is calculated and compared to the desired slope, which is specified by the SLOPE bit in Register 0x33[6]. For optimal ac performance, the best setting for the search is a positive slope and a phase value of 14. If the phase and slope match the configured values, the search algorithm is finished. The SEARCH\_TOL bit (Register 0x2F[7]) can be used to specify the accuracy of the search as follows:

- Not exact (0): can find a phase within two values of the desired phase
- Exact (1): finds the exact phase specified (optimal setting)

Figure 118 shows a typical plot of mu phase vs. mu delay line value at 2.4 GSPS. Starting at the selected mu delay value, the search direction can be specified via the SEARCH\_DIR[1:0] bits in Register 0x39[6:5]. The three possible choices for the search are as follows:

- Down only (00)
- Up only (01)
- Alternating up and down (10) (optimal setting)

If the search direction is alternating, the search proceeds in both directions until a programmable guard band is reached in one of the directions, specified by the GUARDBAND[4:0] bits in Register 0x2F[4:0]. When the guard band is reached, the search continues only in the opposite direction. If the desired phase is not found before the guard band is reached in the second direction, the search reverts to the alternating mode and continues looking within the guard band.

The search fails if the mu delay reaches the endpoints. If the controller does not find the desired phase during the search, the TRACK\_ERR bit (Register 0x2F[5]) determines the corrective action as follows:

- Continue (0): continues to search (optimal setting)
- Reset (1)

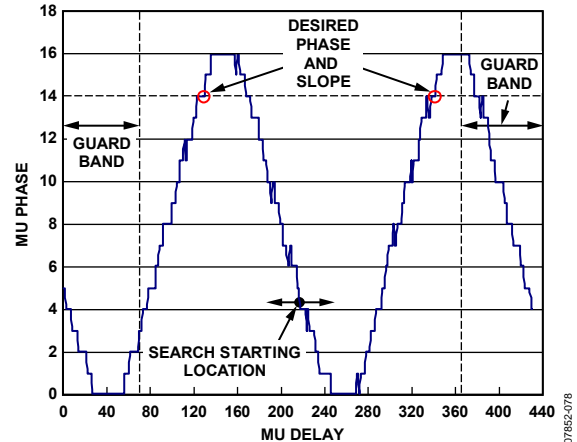

Figure 118. Typical Mu Phase Characteristics @ 2.4 GSPS

To determine whether the search is on the correct slope, the controller measures the slope by first incrementing and then decrementing the mu delay value until any of the following events happens:

- The phase changes by 2.
- The phase is equal to 16 (the maximum value).
- The phase is equal to 0 (the minimum value).
- The mu delay is 431 (the maximum value).
- The mu delay is 0 (the minimum value).

After incrementing and then decrementing the mu delay value, the values of the measured phases are compared to determine whether the slope matches the desired slope. To consider the slope valid, the positive direction phase and the negative direction phase must be on opposite sides of the desired phase. Examples of valid and invalid phase choices are shown in Figure 119 and Figure 120.

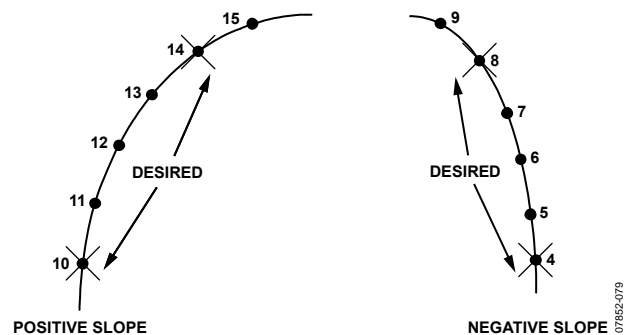

Figure 119. Valid Positive and Negative Slope Phase Examples

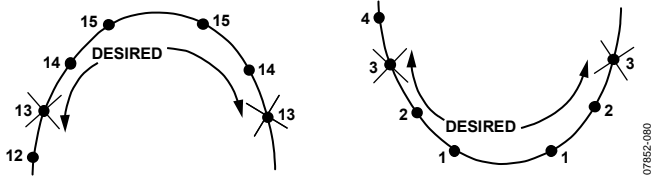

Figure 120. Invalid Slope Phase Examples

When the initial mu delay value has been found by the search algorithm, the tracking mode is enabled. In tracking mode, a simple control loop is used to increment by 1, decrement by 1, or not change the mu delay value depending on the measured phase. The control loop uses the desired slope to determine whether the mu delay should be incremented or decremented. No attempt is made to determine whether the actual slope has changed or is still valid.

Two status bits, LOCKACQ (Register 0x04[3]) and LOCKLOST (Register 0x04[2]) are available to signal proper operation of the control loop. If the current phase is more than five steps away from the desired phase and the LOCKACQ bit was previously set, the LOCKACQ bit is cleared and the LOCKLOST interrupt bit is set. Furthermore, if lock is lost, the controller can remain in the tracking loop, or it can be reset to start the search again.

By setting the MUSAMP bit high (Register 0x33[3]) from a low state, the user can read back the mu delay value that the controller locked to by reading the MUDLY bits (Register 0x39[7] and Register 0x3A[7:0]), as well as the phase it locked to by reading back the MUPHZ[4:0] bits (Register 0x39[4:0]). These bits will no longer read back the value that the search started at or the desired phase, but instead will read back the mu delay line value and phase that the controller is locked to.

Table 78 lists register writes and reads to lock to the controller. The program assumes that the clock receiver is already enabled and that a clean lock is provided. The typical locking time for the mu controller is approximately 180,000 DAC cycles (at 2 GSPS, ~75 μs).

Table 78. AD9789 Mu Delay Controller Routine

Address	Data	R/W	Description
0x30	0x80	Write	Enable duty cycle correction.
0x31	0xF0	Write	Set common-mode level of CLKN: CLKN_CML = 0xF.
0x32	0x9E	Write	Set common-mode level of CLKP: CLKP_CML = 0xF. Set direction of CLKP_CML and CLKN_CML: PSIGN = 0; NSIGN = 0. Enable clock receiver: CLK_DIS = 1.
0x3E	0x38	Write	Set phase comparator boost (AUTO_CAL must be set to its default value, 1).
0x24	0x00	Write	Enable digital clocks.
0x24	0x80	Write	
0x2F	0xCE	Write	Search for exact phase with a guard band of 98 codes from endpoints.
0x33	0x42	Write	Set search slope to positive.
0x39	0x4E	Write	Set search phase to 14, search up and down.
0x3A	0x6C	Write	Set start point of search to mid-point of mu delay line (Code 216).
0x03	0x00	Write	Disable lock and lock lost indicators.
0x04	0xFE	Write	Clear lock and lock lost indicators.
0x03	0x0C	Write	Enable lock and lock lost indicators.
0x33	0x43	Write	Enable mu delay controller and start search/track routine.
0x33	0x4B	Write	Set mu phase read bit high.
0x33	0x43	Write	Set mu phase read bit low.
0x04		Read	Check lock and lock lost bits: LOCKACQ should be on. LOCKLOST should be off.
0x39		Read	Check phase readback (should be equal to 14).

### Operating the Mu Controller in Manual Mode

In manual mode, the user must sweep through all the mu delay values and record the phase value at each value of MUDLY as shown in Figure 118. Every time that the MUDLY value is stepped, the MUSAMP bit must be toggled from low to high to read the corresponding phase for the specified mu delay line value. It is not possible to keep read high and continuously read back the phase value. As with auto mode, the optimal ac performance occurs at a positive slope and a phase of 14; therefore, when the curve is complete, choose the MUDLY value that corresponds to this condition and write that value to the MUDLY[8:0] bits (Register 0x39[7] and Register 0x3A).

### Calculating Mu Delay Line Step Size

Stepping through all of the mu delay line values and plotting mu phase vs. mu delay not only allows the user to find the optimal mu delay value, but can also allow the user to determine the mu delay line step size. To calculate the step size, take one full cycle of the mu phase curve and divide the period of the DAC clock by this delta. From Figure 118, the two transition points are approximately 56 and 270, providing a delta of approximately 214 steps. Therefore, the mu delay line step size would be approximately 2 ps/step, as shown in the following equation:

$$\frac{\left(\frac{1}{2.4 \text{ GHz}}\right)}{214} = 1.95 \text{ ps}$$

If the mu controller is enabled, this value allows the user to calculate (in picoseconds) how much drift is in their system with respect to the DAC clock period over temperature.

### INTERRUPT REQUESTS

The following interrupt (IRQ) requests can be used for additional information and verification of the status of various functional blocks:

- PARERR—triggered when one or more parity errors occurs on the data bus
- PARMSET—triggered when PARMNEW is set and internally registered
- PARMCLR—triggered when PARMNEW is cleared and internally registered
- LOCKACQ—triggered when the mu controller is locked to the user-defined phase
- LOCKLOST—triggered when the mu controller loses lock (if the LOCKACQ bit was previously set)
- SATERR—triggered when one or more saturation errors occurs

Each IRQ is enabled using the enable bits in the interrupt enable register, Register 0x03. The status of the IRQ can be measured in one of the following ways: via the SPI bits found in the interrupt status/clear register (Register 0x04) or using the IRQ pin (Pin P2).

If the pin is used to determine that an interrupt has occurred, it is necessary to check Register 0x04 to determine which bit caused the interrupt because the pin indicates only that an interrupt has occurred. To clear an IRQ, it is necessary to write a 1 to the bit in Register 0x04 that corresponds to the interrupt.

**RECOMMENDED START-UP SEQUENCE**

The steps necessary to optimize the performance of the part and generate an output waveform are listed in Table 79.

**Table 79. Recommended System Start-Up Sequence**

Step	Description	Register	Data
0	Power up the AD9789.		
0	Apply the clock.		
1	Enable the clock receiver and set the clock CML.	0x32	0x9E
1	Enable duty cycle correction.	0x30	0x80
2	Enable digital clocks.	0x24	0x00
3		0x24	0x80
4	Set up mu controller.	0x2F	0xCE
4		0x33	0x42
4		0x39	0x4E
4		0x3A	0x6C
5	Disable all interrupts.	0x03	0x00
6	Clear all interrupts.	0x04	0xFE
7	Enable mu control interrupts.	0x03	0x0C
8	Enable mu delay controller.	0x33	0x43
9	Set up digital datapath.	0x06 to 0x15	
9	Set up rate converter.	0x16 to 0x1B	
9	Set up BPF center frequency.	0x1C to 0x1D	
9	Set up interface.	0x20 to 0x23	
9	Set up channel gains.	0x25 to 0x28	
9	Set up spectral invert.	0x29	
9	Set up full-scale current.	0x3C to 0x3D	
10	Wait until mu delay controller is locked (SPI read) <sup>1</sup> .	0x04	0x08
11	Update rate converter and BPF.	0x1E	0x80
12	Update interface clocks.	0x24	0x00
13		0x24	0x80
14	Enable channels.	0x05	
15	Enable other interrupts if desired.	0x03	

<sup>1</sup> Typical lock time of the mu controller is approximately 180,000 DAC cycles (at 2 GSPS, ~75  $\mu$ s).

## CUSTOMER BIST MODES

### USING THE INTERNAL PRN GENERATOR TO TEST QAM OUTPUT AC PERFORMANCE

The AD9789 can be configured to enable an on-chip pseudo-random number (PRN) generator. The PRN output is connected to the front end of the datapath and disconnects the datapath from the input pins. In this way, the PRN generator can be used in conjunction with the on-chip QAM encoder to generate a QAM output. The PRN generator allows the user to measure the ac performance of a QAM signal at the DAC output without an external data source. To enable the internal PRN generator via the serial port, follow these steps.

1. Ensure that the clock is enabled and that the clock common-mode level is set to its optimal value by setting the registers in Table 80 to the values shown in the table.

**Table 80. Register Settings to Configure the Clock**

Register	Data	Description
0x30	0x80	Enable duty cycle correction.
0x31	0xF0	Set the common-mode level of CLKN: CLKN_CML = 0xF.
0x32	0x9E	Set the common-mode level of CLKP: CLKP_CML = 0xF. Set PSIGN = 0, NSIGN = 0. Enable clock receiver (CLK_DIS = 1).

2. Configure BIST mode for PRN generation and disconnect the inputs by setting the registers in Table 81 to the values shown in the table.

**Table 81. Register Settings to Configure PRN Generation**

Register	Setting
0x42	0x10
0x43	0x00
0x44	0x10
0x45	0x00
0x46	0x00
0x47	0x10
0x49	0x16
0x4B	0x17
0x4C	0x4E
0x4D	0x1F
0x05	0x0F

3. Cycle the PARMNEW bit to ensure that the digital clocks are active by first setting Register 0x24 to 0x00, and then setting Register 0x24 to 0x80.
4. Start PRN generation by setting the registers in Table 82 to the values shown in the table.

**Table 82. Register Settings to Start PRN Generation**

Register	Setting
0x48	0xAB
0x4A	0xAB
0x40	0x56

After the PRN generator is started, users can freely configure the datapath for their desired test configuration as long as Register 0x40 to Register 0x55 are not modified.

To disable the PRN generator, write 0x00 to Register 0x40.

### USING THE INTERNAL BUILT-IN SELF-TEST (BIST) TO TEST FOR DIGITAL DATA INPUT CONNECTIVITY

The AD9789 includes an internal built-in self-test (BIST) engine that processes incoming data and creates a signature that can be read back via the serial port. This BIST feature can be configured to observe the static state of the digital data input pins (L4 to L12, M4 to M12, N5 to N12, and P5 to P12) and to reflect the state of these pins via the signature registers (Register 0x50 to Register 0x55). In this way, the user can verify digital data input connectivity.

#### Testing Connectivity for LVDS Interface Mode

To test the connectivity of the digital data input pins in LVDS interface mode, follow these steps.

1. Ensure that the clock is enabled and that the clock common-mode level is set to its optimal value by setting the registers in Table 83 to the values shown in the table.

**Table 83. Register Settings to Configure the Clock**

Register	Data	Description
0x30	0x80	Enable duty cycle correction.
0x31	0xF0	Set the common-mode level of CLKN: CLKN_CML = 0xF.
0x32	0x9E	Set the common-mode level of CLKP: CLKP_CML = 0xF. Set PSIGN = 0, NSIGN = 0. Enable clock receiver (CLK_DIS = 1).

2. Cycle the PARMNEW bit to ensure that the digital clocks are active by first setting Register 0x24 to 0x00, and then setting Register 0x24 to 0x80.
3. Configure the LVDS interface for high speed, 16-bit bus width, 16-bit data width operation by setting the registers in Table 84 to the values shown in the table.

**Table 84. Register Settings for LVDS Interface**

Register	Setting
0x20	0x08
0x21	0x41
0x22	0x1F
0x23	0x87

- Configure pin mode by setting the registers in Table 85 to the values shown in the table.

**Table 85. Register Settings to Configure Pin Modes**

Register	Setting
0x42	0x00
0x43	0x08
0x44	0x00
0x45	0x08
0x46	0x00
0x47	0x10
0x49	0x1C
0x4B	0x1C
0x4C	0x00
0x4D	0x00

- Cycle the PARMNEW bit to ensure that the interface configuration was updated by first setting Register 0x24 to 0x00, and then setting Register 0x24 to 0x80.
- Apply static LVDS data to the input ports.
- Enable the BIST pin test by setting the registers in Table 86 to the values shown in the table.

**Table 86. Register Settings for BIST Pin Test**

Register	Setting
0x48	0x80
0x4A	0x80
0x40	0x55

- Read back the signature registers (Register 0x50 to Register 0x55) to determine the pin states (see Table 87).

**Table 87. Signature Register Settings**

Register	Associated LVDS Pairs
0x50	Data bits D[7:0]
0x51	Data bits D[15:8]
0x52	Parity PAR
0x53	Data bits D[7:0] (repeated)
0x54	Data bits D[15:8] (repeated)
0x55	Parity PAR (repeated)

**Testing Connectivity for CMOS Interface Mode**

To test the connectivity of the digital data input pins in CMOS interface mode, follow these steps.

- Ensure that the clock is enabled and that the clock common-mode level is set to its optimal value by setting the registers in Table 88 to the values shown in the table.

**Table 88. Register Settings to Configure the Clock**

Register	Data	Description
0x30	0x80	Enable duty cycle correction.
0x31	0xF0	Set the common-mode level of CLKN: CLKN_CML = 0xF.
0x32	0x9E	Set the common-mode level of CLKP: CLKP_CML = 0xF. Set PSIGN = 0, NSIGN = 0. Enable clock receiver (CLK_DIS = 1).

- Cycle the PARMNEW bit to ensure that the digital clocks are active by first setting Register 0x24 to 0x00, and then setting Register 0x24 to 0x80.
- Configure the CMOS interface for high speed, 32-bit bus width, 16-bit data width operation by setting the registers in Table 89 to the values shown in the table.

**Table 89. Register Settings for CMOS Interface**

Register	Setting
0x20	0x08
0x21	0x61
0x22	0x1F
0x23	0x87

- Configure pin mode by setting the registers in Table 90 to the values shown in the table.

**Table 90. Register Settings to Configure Pin Modes**

Register	Setting
0x42	0x00
0x43	0x08
0x44	0x00
0x45	0x08
0x46	0x00
0x47	0x10
0x49	0x1C
0x4B	0x1C
0x4C	0x00
0x4D	0x00

- Cycle the PARMNEW bit to ensure that the interface configuration was updated by first setting Register 0x24 to 0x00, and then setting Register 0x24 to 0x80.
- Apply static CMOS data to the input ports.
- Enable the BIST pin test by setting the registers in Table 91 to the values shown in the table.

**Table 91. Register Settings for BIST Pin Test**

Register	Setting
0x48	0x80
0x4A	0x80
0x40	0x55

- Read back the signature registers (Register 0x50 to Register 0x55) to determine the pin states (see Table 92).

**Table 92. Signature Register Settings**

Register	Associated CMOS Pairs
0x50	Data bits D[23:16]
0x51	Data bits D[31:24]
0x52	Parity P1
0x53	Data bits D[7:0]
0x54	Data bits [D15:8]
0x55	Parity P0



# QAM CONSTELLATION MAPS

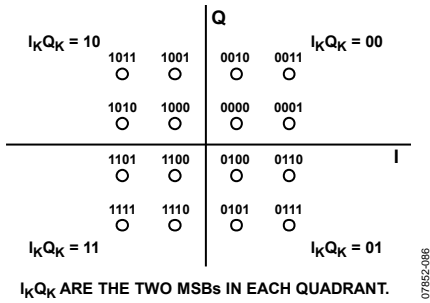

Figure 121. DVB 16-QAM Constellation

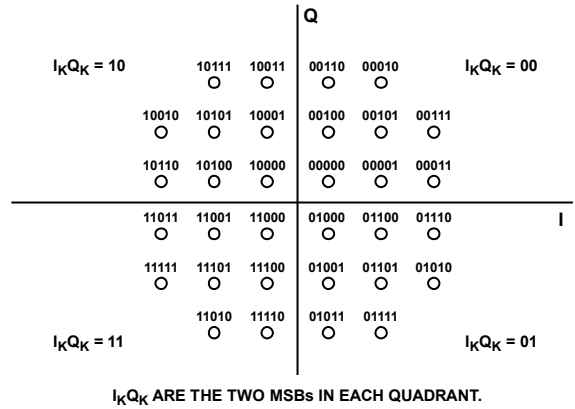

Figure 123. DVB 32-QAM Constellation

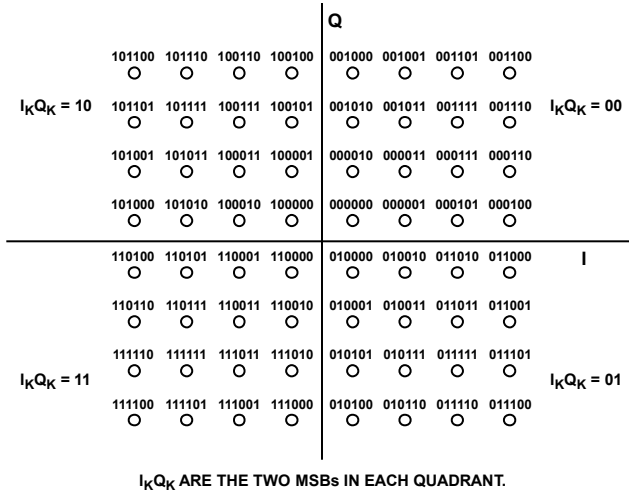

Figure 122. DVB 64-QAM Constellation

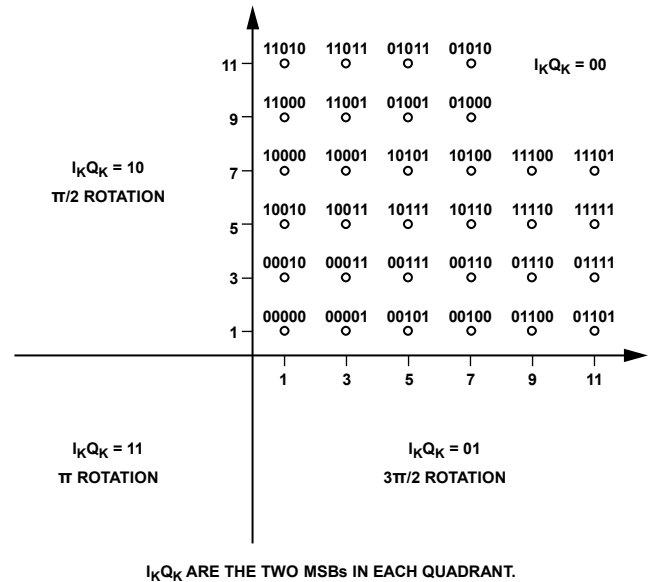
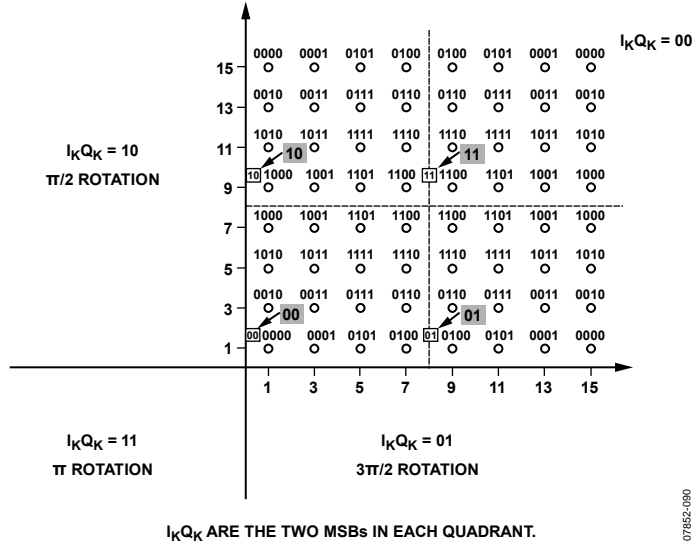

Figure 124. DVB 128-QAM Constellation



$I_K Q_K$  ARE THE TWO MSBs IN EACH QUADRANT.

Figure 125. DVB 256-QAM Constellation

07852-080

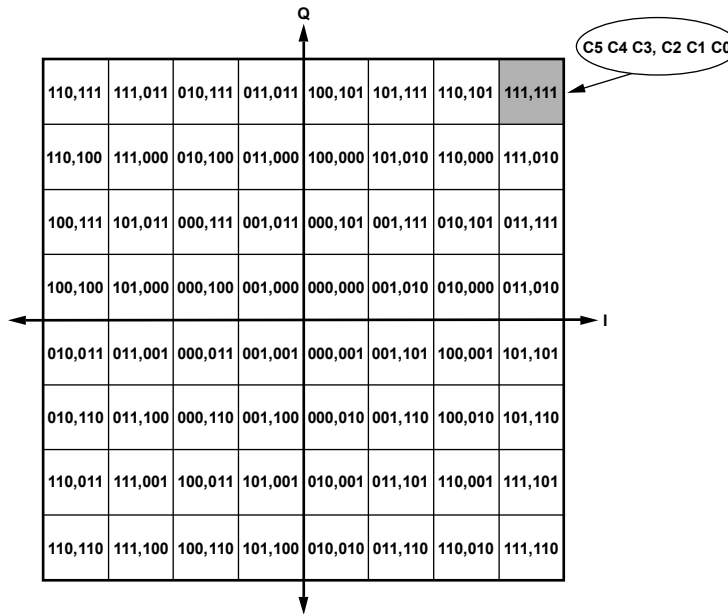

Figure 126. DOCSIS 64-QAM Constellation

07852-081

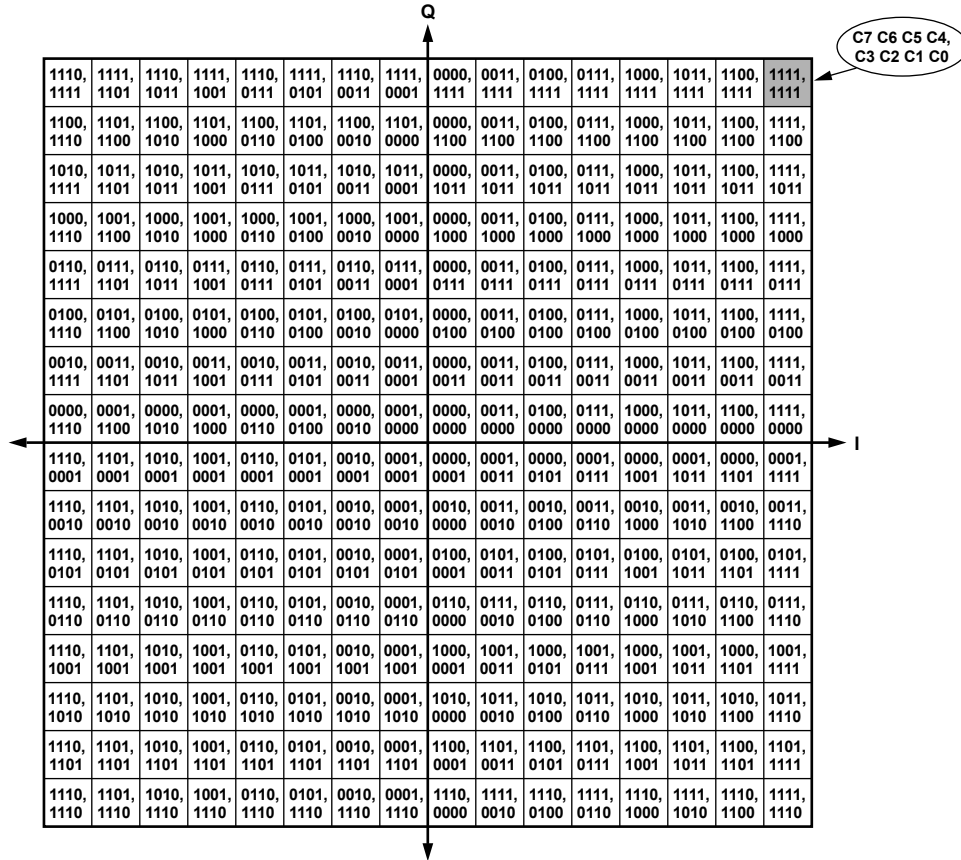

Figure 127. DOCSIS 256-QAM Constellation

07862-126

## CHANNELIZER MODE PIN MAPPING FOR CMOS AND LVDS

Table 93 lists the available combinations of data input configuration parameters when the AD9789 is in channelizer mode. Many of these configurations require multiple clocks to load all channels. All of these configurations are described in detail in Table 96 and Table 97.

Table 94 and Table 95, along with Figure 128 and Figure 129, describe CMOS and LVDS data input pin mapping. CMOS mode is always single data rate and samples on the rising edge of DSC. LVDS mode is single data rate (SDR) for bus widths of 4 bits through 16 bits and double data rate (DDR) for a bus width of 32 bits.

**Table 93. Data Input Configurations for Channelizer Mode**

Bus Width	Data Width	Data Format
4	8	Real
4	8	Complex
8	8	Real
8	8	Complex
8	16	Complex
16	8	Real
16	8	Complex
16	16	Complex
32	8	Real
32	8	Complex
32	16	Complex

**Table 94. CMOS Pin Assignments for Various Interface Widths**

Interface Width	Pin Assignments	BUSWIDTH[1:0]
4 bits	D[3:0]	00
8 bits	D[7:0]	01
16 bits	D[15:0]	10
32 bits	D[31:0]	11

**Table 95. LVDS Pin Assignments for Various Interface Widths**

Interface Width	Pin Assignments	BUSWIDTH[1:0]
4 bits	D[3:0]P, D[3:0]N	00
8 bits	D[7:0]P, D[7:0]N	01
16 bits	D[15:0]P, D[15:0]N	10
32 bits	D[15:0]P, D[15:0]N rising edge and falling edge	11

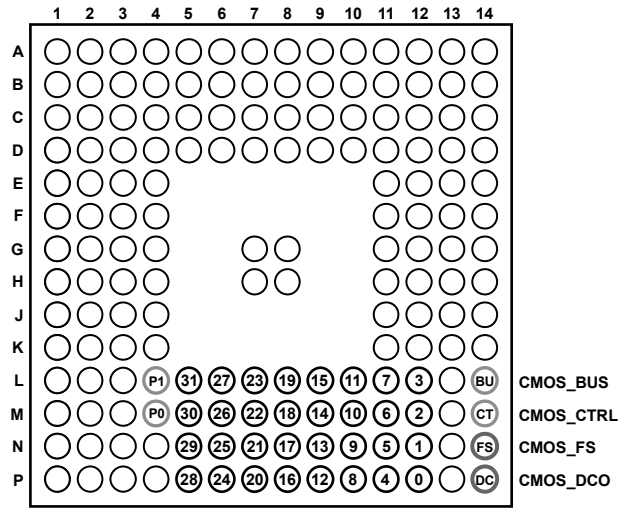

○ D[31:0] CMOS DATA INPUTS  
 ◐ PARITY AND CONTROL INPUTS

Figure 128. CMOS Data Input Pin Mapping

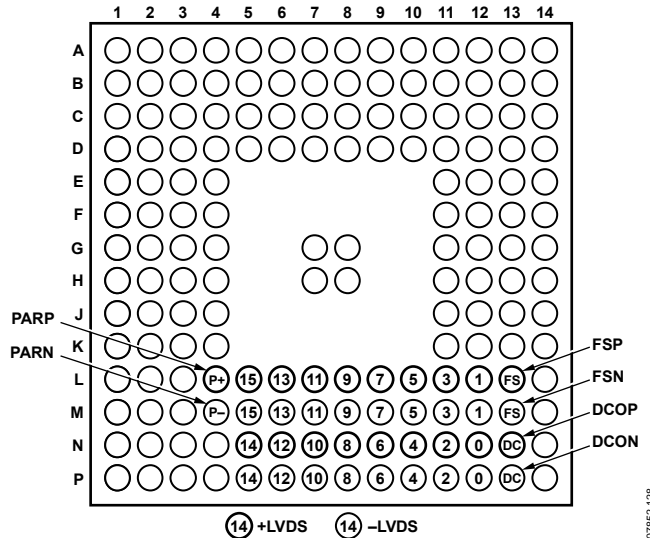

○ +LVDS ◐ -LVDS

Figure 129. LVDS Data Input Pin Mapping

[查询"AD9789"供应商](#)

In Table 96, “R” represents real data loaded to a given channel, “I” represents the in-phase term, and “Q” represents the quadrature term of complex data. The channel number follows R, I, or Q.

**Table 96. Channelizer Mode Configurations and Channel Construction: CMOS Interface, Channel Prioritization = 1**

Datapath Configuration			CMOS Pin Mapping											
BW	DW	Format	DCO	[D31:D28]	[D27:D24]	[D23:D20]	[D19:D16]	[D15:D12]	[D11:D8]	[D7:D4]	[D3:D0]			
4	8	Real	1									R0		
			2									R0		
			3										R1	
			4										R1	
			5										R2	
			6										R2	
			7										R3	
			8										R3	
Datapath Configuration			CMOS Pin Mapping											
BW	DW	Format	DCO	[D31:D28]	[D27:D24]	[D23:D20]	[D19:D16]	[D15:D12]	[D11:D8]	[D7:D4]	[D3:D0]			
4	8	Complex	1									I0		
			2									I0		
			3										Q0	
			4										Q0	
			5										I1	
			6										I1	
			7										Q1	
			8										Q1	
			9											I2
			10											I2
			11											Q2
			12											Q2
			13											I3
			14											I3
			15											Q3
			16											Q3
Datapath Configuration			CMOS Pin Mapping											
BW	DW	Format	DCO	[D31:D28]	[D27:D24]	[D23:D20]	[D19:D16]	[D15:D12]	[D11:D8]	[D7:D4]	[D3:D0]			
8	8	Real	1									R0		
			2									R1		
			3									R2		
			4									R3		
Datapath Configuration			CMOS Pin Mapping											
BW	DW	Format	DCO	[D31:D28]	[D27:D24]	[D23:D20]	[D19:D16]	[D15:D12]	[D11:D8]	[D7:D4]	[D3:D0]			
8	8	Complex	1									I0		
			2									Q0		
			3									I1		
			4									Q1		
			5									I2		
			6									Q2		
			7									I3		
			8									Q3		

# AD9789

[查询"AD9789"供应商](#)

Datapath Configuration			CMOS Pin Mapping										
BW	DW	Format	DCO	[D31:D28]	[D27:D24]	[D23:D20]	[D19:D16]	[D15:D12]	[D11:D8]	[D7:D4]	[D3:D0]		
8	16	Complex	1								I0		
			2								I0		
			3									Q0	
			4									Q0	
			5									I1	
			6									I1	
			7										Q1
			8										Q1
			9										I2
			10										I2
			11										Q2
			12										Q2
			13										I3
			14										I3
			15										Q3
			16										Q3
Datapath Configuration			CMOS Pin Mapping										
BW	DW	Format	DCO	[D31:D28]	[D27:D24]	[D23:D20]	[D19:D16]	[D15:D12]	[D11:D8]	[D7:D4]	[D3:D0]		
16	8	Real	1						R1		R0		
			2						R3		R2		
Datapath Configuration			CMOS Pin Mapping										
BW	DW	Format	DCO	[D31:D28]	[D27:D24]	[D23:D20]	[D19:D16]	[D15:D12]	[D11:D8]	[D7:D4]	[D3:D0]		
16	8	Complex	1						Q0		I0		
			2						Q1		I1		
			3							Q2		I2	
			4							Q3		I3	
Datapath Configuration			CMOS Pin Mapping										
BW	DW	Format	DCO	[D31:D28]	[D27:D24]	[D23:D20]	[D19:D16]	[D15:D12]	[D11:D8]	[D7:D4]	[D3:D0]		
16	16	Complex	1								I0		
			2								Q0		
			3									I1	
			4									Q1	
			5									I2	
			6									Q2	
			7									I3	
			8									Q3	
Datapath Configuration			CMOS Pin Mapping										
BW	DW	Format	DCO	[D31:D28]	[D27:D24]	[D23:D20]	[D19:D16]	[D15:D12]	[D11:D8]	[D7:D4]	[D3:D0]		
32	8	Real	1		R3		R2		R1		R0		
			2										
Datapath Configuration			CMOS Pin Mapping										
BW	DW	Format	DCO	[D31:D28]	[D27:D24]	[D23:D20]	[D19:D16]	[D15:D12]	[D11:D8]	[D7:D4]	[D3:D0]		
32	8	Complex	1		Q1		I1		Q0		I0		
			2		Q3		I3		Q2		I2		
Datapath Configuration			CMOS Pin Mapping										
BW	DW	Format	DCO	[D31:D28]	[D27:D24]	[D23:D20]	[D19:D16]	[D15:D12]	[D11:D8]	[D7:D4]	[D3:D0]		
32	16	Complex	1								I0		
			2								I1		
			3								I2		
			4								I3		

In DDR mode, “rise” corresponds to data sampled on the rising edge of DSC; “fall” corresponds to data sampled on the falling edge of DSC.

Table 97. Channelizer Mode Configurations and Channel Construction: LVDS Interface, Channel Prioritization = 1

Datapath Configuration			LVDS Pin Mapping				
BW	DW	Format	DCO	[D15:D12]	[D11:D8]	[D7:D4]	[D3:D0]
4	8	Real	1				R0
			2				R0
			3				R1
			4				R1
			5				R2
			6				R2
			7				R3
			8				R3
Datapath Configuration			LVDS Pin Mapping				
BW	DW	Format	DCO	[D15:D12]	[D11:D8]	[D7:D4]	[D3:D0]
4	8	Complex	1				I0
			2				I0
			3				Q0
			4				Q0
			5				I1
			6				I1
			7				Q1
			8				Q1
			9				I2
			10				I2
			11				Q2
			12				Q2
			13				I3
			14				I3
			15				Q3
			16				Q3
Datapath Configuration			LVDS Pin Mapping				
BW	DW	Format	DCO	[D15:D12]	[D11:D8]	[D7:D4]	[D3:D0]
8	8	Real	1				R0
			2				R1
			3				R2
			4				R3
Datapath Configuration			LVDS Pin Mapping				
BW	DW	Format	DCO	[D15:D12]	[D11:D8]	[D7:D4]	[D3:D0]
8	8	Complex	1				I0
			2				Q0
			3				I1
			4				Q1
			5				I2
			6				Q2
			7				I3
			8				Q3

# AD9789

[查询"AD9789"供应商](#)

Datapath Configuration			LVDS Pin Mapping				
BW	DW	Format	DCO	[D15:D12]	[D11:D8]	[D7:D4]	[D3:D0]
8	16	Complex	1				I0
			2				I0
			3				Q0
			4				Q0
			5				I1
			6				I1
			7				Q1
			8				Q1
			9				I2
			10				I2
			11				Q2
			12				Q2
			13				I3
			14				I3
			15				Q3
			16				Q3
Datapath Configuration			LVDS Pin Mapping				
BW	DW	Format	DCO	[D15:D12]	[D11:D8]	[D7:D4]	[D3:D0]
16	8	Real	1		R1		R0
			2		R3		R2
Datapath Configuration			LVDS Pin Mapping				
BW	DW	Format	DCO	[D15:D12]	[D11:D8]	[D7:D4]	[D3:D0]
16	8	Complex	1		Q0		I0
			2		Q1		I1
			3		Q2		I2
			4		Q3		I3
Datapath Configuration			LVDS Pin Mapping				
BW	DW	Format	DCO	[D15:D12]	[D11:D8]	[D7:D4]	[D3:D0]
16	16	Complex	1				I0
			2				Q0
			3				I1
			4				Q1
			5				I2
			6				Q2
			7				I3
			8				Q3
Datapath Configuration			LVDS Pin Mapping				
BW	DW	Format	DCO	[D15:D12]	[D11:D8]	[D7:D4]	[D3:D0]
32	8	Real	1 rise		R1		R0
			1 fall		R3		R2
Datapath Configuration			LVDS Pin Mapping				
BW	DW	Format	DCO	[D15:D12]	[D11:D8]	[D7:D4]	[D3:D0]
32	8	Complex	1 rise		Q0		I0
			1 fall		Q1		I1
			2 rise		Q2		I2
			2 fall		Q3		I3



[查询"AD9789"供应商](#)

Datapath Configuration			LVDS Pin Mapping				
BW	DW	Format	DCO	[D15:D12]	[D11:D8]	[D7:D4]	[D3:D0]
32	16	Complex	1 rise			I0	
			1 fall			Q0	
			2 rise			I1	
			2 fall			Q1	
			3 rise			I2	
			3 fall			Q2	
			4 rise			I3	
			4 fall			Q3	

# OUTLINE DIMENSIONS

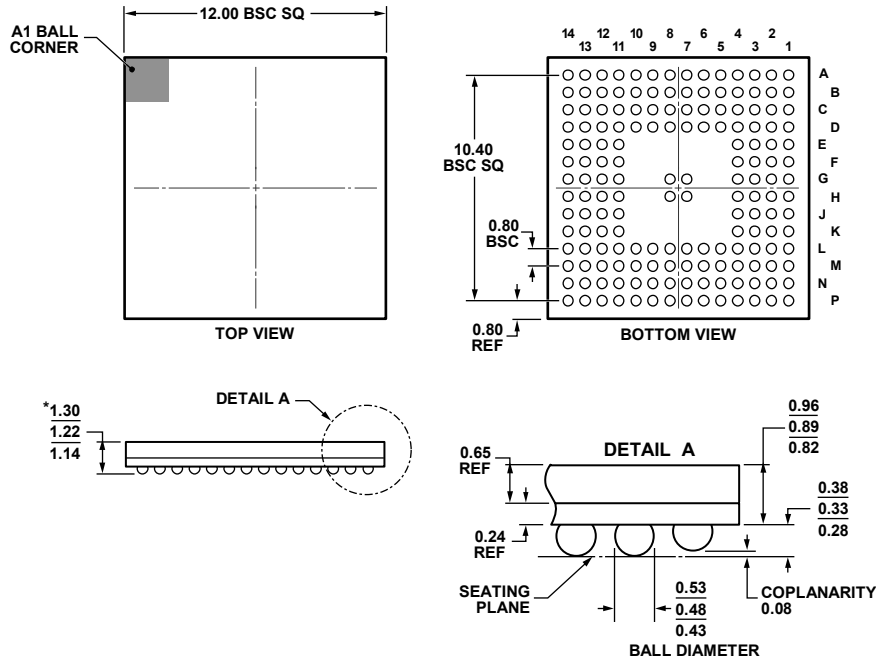

\*COMPLIANT TO JEDEC STANDARDS MO-219 WITH THE EXCEPTION TO PACKAGE HEIGHT.

Figure 130. 164-Ball Chip Scale Package Ball Grid Array [CSP\_BGA] (BC-164-1)

Dimensions shown in millimeters

11608-A

## ORDERING GUIDE

Model	Temperature Range	Package Description	Package Option
AD9789BBCZ <sup>1</sup>	-40°C to +85°C	164-Ball Chip Scale Package Ball Grid Array (CSP_BGA)	BC-164-1
AD9789BBCZRL <sup>1</sup>	-40°C to +85°C	164-Ball Chip Scale Package Ball Grid Array (CSP_BGA)	BC-164-1
AD9789BBC	-40°C to +85°C	164-Ball Chip Scale Package Ball Grid Array (CSP_BGA)	BC-164-1
AD9789BBCRL	-40°C to +85°C	164-Ball Chip Scale Package Ball Grid Array (CSP_BGA)	BC-164-1
AD9789-EBZ <sup>1</sup>		Evaluation Board for CMTS and Normal Mode Evaluation	
AD9789-MIX-EBZ <sup>1</sup>		Evaluation Board for Mix Mode Evaluation	

<sup>1</sup> Z = RoHS Compliant Part.

**NOTES**

**AD9789**

[查询"AD9789"供应商](#)

## NOTES