

A_LT-2W & B_LT-2W Series

2W, FIXED INPUT, ISOLATED & UNREGULATED, DUAL/SINGLE OUTPUT, SMD, DC-DC CONVERTER

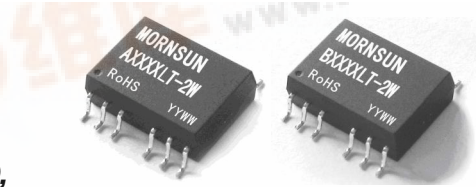

multi-country patent protection **RoHS**

FEATURES

- High Efficiency up to 85%
- SMD Package
- 1KVDC Isolation
- Temperature Range: -40°C to +85°C
- Internal SMD Construction
- No Heat sink Required
- No External Component Required
- Industry Standard Pinout
- RoHS Compliance

APPLICATIONS

The A_LT-2W & B_LT-2W Series are specially designed for applications where a group of polar power supplies are isolated from the input power supply in a distributed power supply system on a circuit board.

These products apply to:

- Where the voltage of the input power supply is fixed (voltage variation $\leq \pm 10\%$);
- Where isolation is necessary between input and output (isolation voltage $\leq 1000\text{VDC}$);
- Where the regulation of the output voltage and the output ripple noise are not demanding.

Such as: purely digital circuits, ordinary low frequency analog circuits, and IGBT power device driving circuits.

MODEL SELECTION

A0505LT-2W

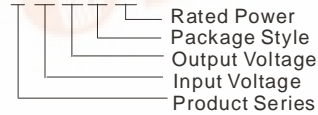

MORNSUN Science & Technology co., Ltd.

Address: 2th floor 6th building, Hangzhou Industrial District, Guangzhou, China
Tel: 86-20-38601850
Fax: 86-20-38601272
<http://www.mornsun-power.com>

PRODUCT PROGRAM

Part Number	Input		Output			Efficiency (% Typ)
	Voltage (VDC)		Voltage (VDC)	Current (mA)		
	Nominal	Range		Max	Min	
A0505LT-2W	5	4.5-5.5	±5	±200	±20	82
A0509LT-2W			±9	±111	±11	83
A0512LT-2W			±12	±83	±8	84
A0515LT-2W			±15	±67	±7	82
B0505LT-2W			5	400	40	80
B0509LT-2W			9	222	23	82
B0512LT-2W			12	167	17	84
B0515LT-2W			15	133	14	84
A1205LT-2W			12	10.8-13.2	±5	±200
A1209LT-2W	±9	±111			±11	84
A1212LT-2W	±12	±83			±8	84
A1215LT-2W	±15	±67			±7	85
B1205LT-2W	5	400			40	82
B1209LT-2W	9	222			23	83
B1212LT-2W	12	167			17	85
B1215LT-2W	15	133			14	85

OUTPUT SPECIFICATIONS

Item	Test Conditions	Min	Typ	Max	Units
Output power		0.2		2	W
Line regulation	For Vin change of 1%			±1.2	%
Load regulation	10% to 100% load (5V output)		12.8	15	%
	10% to 100% load (9V output)		8.3	15	
	10% to 100% load (12V output)		6.8	15	
	10% to 100% load (15V output)		6.3	15	
Output voltage accuracy		See tolerance envelope graph			
Temperature drift	100% full load			0.03	%/°C
Ripple & Noise*	20MHz Bandwidth		75	150	mVp-p
Switching frequency	Full load, nominal input		70		KHz

*Test ripple and noise by "parallel cable" method. See detailed operation instructions at Testing of Power Converter

COMMON SPECIFICATION

Item	Test Conditions	Min	Typ	Max	Units
Storage humidity				95	%
Operating temperature		-40		85	°C
Storage temperature		-55		125	
Lead temperature			15	25	
Temp. rise at full load	1.5mm from case for 10 seconds			260	
Cooling		Free air convection			
Short circuit protection*				1	s
Case material		Plastic(UL94-V0)			
MTBF		3500			K hours
Weight			2.1		g

*Supply voltage must be discontinued at the end of short circuit duration.

Note: 1.All specifications measured at TA=25°C, humidity<75%, nominal input voltage and rated output load unless otherwise specified.

2. See below recommended circuits for more details.



ISOLATION CHARACTERISTICS

Item	Test Conditions	Min	Typ	Max	Units
Isolation voltage	Tested for 1 minute and 1mA max	1000			VDC
Isolation resistance	Test at 500VDC	1000			MΩ

TYPICAL CHARACTERISTICS

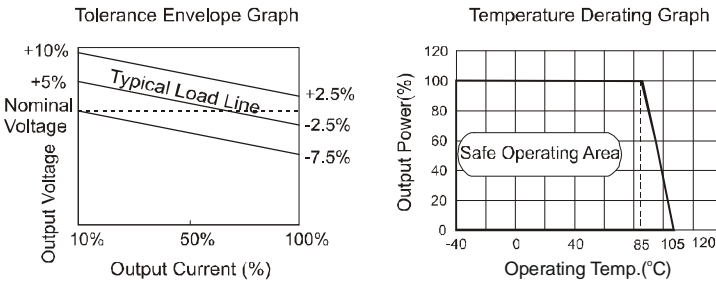

RECOMMENDED REFLOW SOLDERING PROFILE

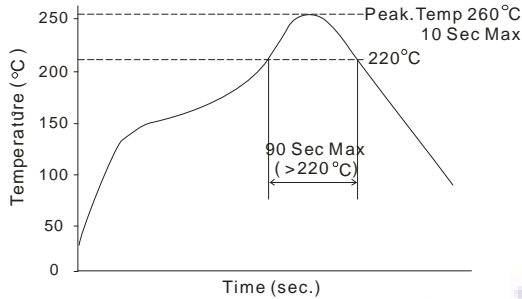

OUTLINE DIMENSIONS & PIN CONNECTIONS

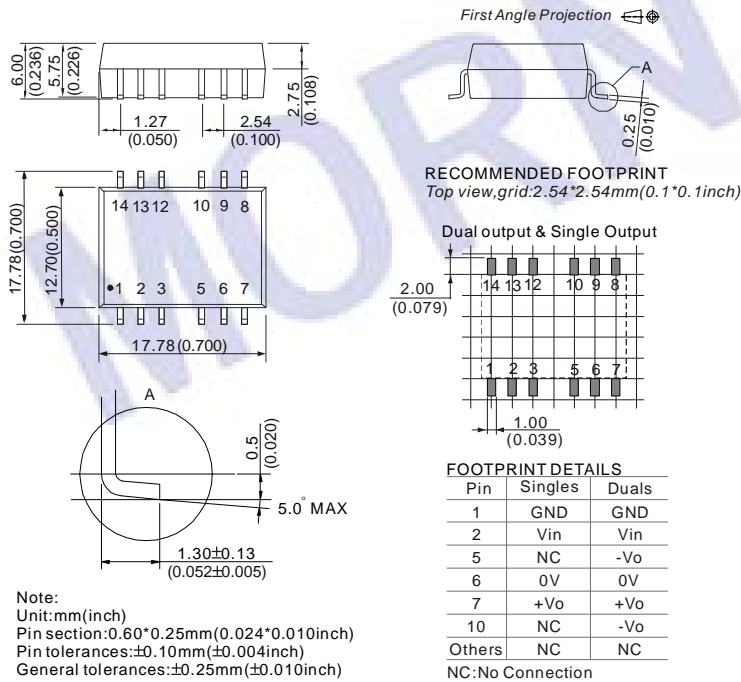

APPLICATION NOTE

Requirement on output load

To ensure this module can operate efficiently and reliably, During operation, the minimum output load is **not less than 10%** of the full load, and that **this product should never be operated under no load!** If the actual output power is very small, please connect a resistor with proper resistance at the output end in parallel to increase the load, or use our company's products with a lower rated output power (A_T -1W/B_T-1W series).

Overload Protection

Under normal operating conditions, the output circuit of these products has no protection against overload. The simplest method is to connect a self-recovery fuse in series at the input end or add a circuit breaker to the circuit.

Recommended testing and application circuit

If you want to further decrease the input/output ripple, an "LC" filtering network may be connected to the input and output ends of the DC/DC converter, see (Figure 1).

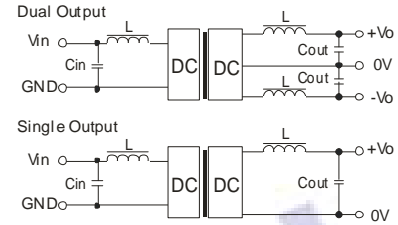

It should also be noted that the inductance and the frequency of the "LC" filtering network should be staggered with the DC/DC frequency to avoid mutual interference. However, the capacitance of the output filter capacitor must be proper. If the capacitance is too big, a startup problem might arise. For every channel of output, provided the safe and reliable operation is ensured, the recommended capacitance of its filter capacitor sees (Table 1).

EXTERNAL CAPACITOR TABLE (TABLE 1)

Vin (VDC)	Cin (uF)	Single Vout (VDC)	Cout (uF)	Dual Vout (VDC)	Cout (uF)
5	4.7	5	10	±5	4.7
12	2.2	9	4.7	±9	2.2
-	-	12	2.2	±12	1
-	-	15	1	±15	0.47

It's not recommended to connect any external capacitor in the application field with less than 0.5 watt output.

Output Voltage Regulation and Over-voltage Protection Circuit

The simplest device for output voltage regulation, over-voltage and over-current protection is a linear voltage regulator with overheat protection that is connected to the input or output end in series (Figure 2).

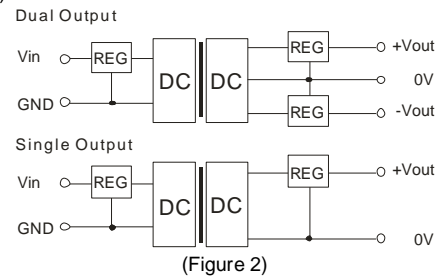

No parallel connection or plug and play.