

查询"MRF5S21130"供应商

MRF5S21130R3 and MRF5S21130SR3 replaced by MRF5S21130HR3 and MRF5S21130HSR3. "H" suffix indicates lower thermal resistance package.

The RF MOSFET Line
RF Power Field Effect Transistors
N-Channel Enhancement-Mode Lateral MOSFETs

Designed for W-CDMA base station applications at frequencies from 2110 to 2170 MHz. Suitable for TDMA, CDMA and multicarrier amplifier applications. To be used in Class AB for PCN - PCS/cellular radio and WLL applications.

- Typical 2-carrier W-CDMA Performance for $V_{DD} = 28$ Volts, $I_{DQ} = 1200$ mA, $f_1 = 2135$ MHz, $f_2 = 2145$ MHz, Channel Bandwidth = 3.84 MHz, Adjacent Channels Measured over 3.84 MHz BW @ $f_1 - 5$ MHz and $f_2 + 5$ MHz, Distortion Products Measured over a 3.84 MHz BW @ $f_1 - 10$ MHz and $f_2 + 10$ MHz, Peak/Avg. = 8.5 dB @ 0.01% Probability on CCDF.
 - Output Power — 28 Watts Avg.
 - Power Gain — 13.5 dB
 - Efficiency — 26%
 - IM3 — -37 dBc
 - ACPR — -39 dBc
- Internally Matched, Controlled Q, for Ease of Use
- High Gain, High Efficiency and High Linearity
- Integrated ESD Protection
- Designed for Maximum Gain and Insertion Phase Flatness
- Capable of Handling 10:1 VSWR, @ 28 Vdc, 2140 MHz, 92 Watts CW Output Power
- Excellent Thermal Stability
- Characterized with Series Equivalent Large-Signal Impedance Parameters
- Qualified Up to a Maximum of 32 V_{DD} Operation
- In Tape and Reel. R3 Suffix = 250 Units per 56 mm, 13 inch Reel.

MRF5S21130R3
MRF5S21130SR3

2170 MHz, 28 W AVG.,
2 x W-CDMA, 28 V
LATERAL N-CHANNEL
RF POWER MOSFETs

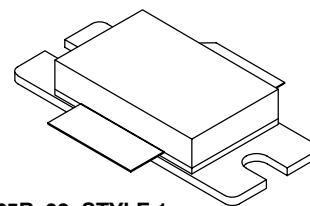

CASE 465B-03, STYLE 1
NI-880
MRF5S21130R3

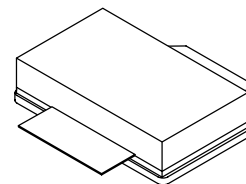

CASE 465C-02, STYLE 1
NI-880S
MRF5S21130SR3

MAXIMUM RATINGS

Rating	Symbol	Value	Unit
Drain-Source Voltage	V_{DSS}	65	Vdc
Gate-Source Voltage	V_{GS}	-0.5, +15	Vdc
Total Device Dissipation @ $T_C = 25^\circ\text{C}$ Derate above 25°C	P_D	315 2	Watts $\text{W}/^\circ\text{C}$
Storage Temperature Range	T_{stg}	- 65 to +150	$^\circ\text{C}$
Operating Junction Temperature	T_J	200	$^\circ\text{C}$
CW Operation	CW	92	Watts

THERMAL CHARACTERISTICS

Characteristic	Symbol	Value (1,2)	Unit
Thermal Resistance, Junction to Case Case Temperature 80°C , 92 W CW Case Temperature 80°C , 28 W CW	$R_{\theta JC}$	0.54 0.56	$^\circ\text{C}/\text{W}$

- (1) MTTF calculator available at <http://www.motorola.com/semiconductors/rf>. Select Tools/Software/Application Software/Calculators to access the MTTF calculators by product.
- (2) Refer to AN1955/D, *Thermal Measurement Methodology of RF Power Amplifiers*. Go to <http://www.motorola.com/semiconductors/rf>. Select Documentation/Application Notes - AN1955.

NOTE - CAUTION - MOS devices are susceptible to damage from electrostatic charge. Reasonable precautions in handling and packaging MOS devices should be observed.

Freescale Semiconductor, Inc. ARCHIVE INFORMATION

ARCHIVE INFORMATION

Freescale Semiconductor, Inc.

ESD PROTECTION CHARACTERISTICS

Conditions	Class
Human Body Model	2 (Minimum)
Machine Model	M4 (Minimum)
Charge Device Model	C7 (Minimum)

ELECTRICAL CHARACTERISTICS (T_C = 25°C unless otherwise noted)

Characteristic	Symbol	Min	Typ	Max	Unit
----------------	--------	-----	-----	-----	------

OFF CHARACTERISTICS

Zero Gate Voltage Drain Leakage Current (V _{DS} = 65 Vdc, V _{GS} = 0 Vdc)	I _{DSS}	—	—	10	μA _{dc}
Zero Gate Voltage Drain Leakage Current (V _{DS} = 28 Vdc, V _{GS} = 0 Vdc)	I _{DSS}	—	—	1	μA _{dc}
Gate-Source Leakage Current (V _{GS} = 5 Vdc, V _{DS} = 0 Vdc)	I _{GSS}	—	—	1	μA _{dc}

ON CHARACTERISTICS

Gate Threshold Voltage (V _{DS} = 10 Vdc, I _D = 300 μA _{dc})	V _{GS(th)}	2.5	2.7	3.5	Vdc
Gate Quiescent Voltage (V _{DS} = 28 Vdc, I _D = 1200 mA _{dc})	V _{GS(Q)}	—	3.7	—	Vdc
Drain-Source On-Voltage (V _{GS} = 10 Vdc, I _D = 3 A _{dc})	V _{DS(on)}	—	0.26	0.3	Vdc
Forward Transconductance (V _{DS} = 10 Vdc, I _D = 3 A _{dc})	g _{fs}	—	7.5	—	S

DYNAMIC CHARACTERISTICS (1)

Reverse Transfer Capacitance (V _{DS} = 28 Vdc ± 30 mV(rms) _{ac} @ 1 MHz, V _{GS} = 0 Vdc)	C _{r_{ss}}	—	2.6	—	pF
--	-----------------------------	---	-----	---	----

FUNCTIONAL TESTS (In Motorola Test Fixture, 50 ohm system) 2-carrier W-CDMA, 3.84 MHz Channel Bandwidth Carriers, ACPR and IM3 measured in 3.84 MHz Bandwidth. Peak/Avg. = 8.5 dB @ 0.01% Probability on CCDF.

Common-Source Amplifier Power Gain (V _{DD} = 28 Vdc, P _{out} = 28 W Avg., I _{DQ} = 1200 mA, f ₁ = 2112.5 MHz, f ₂ = 2122.5 MHz and f ₁ = 2157.5 MHz, f ₂ = 2167.5 MHz)	G _{ps}	12	13.5	—	dB
Drain Efficiency (V _{DD} = 28 Vdc, P _{out} = 28 W Avg., I _{DQ} = 1200 mA, f ₁ = 2112.5 MHz, f ₂ = 2122.5 MHz and f ₁ = 2157.5 MHz, f ₂ = 2167.5 MHz)	η	24	26	—	%
Third Order Intermodulation Distortion (V _{DD} = 28 Vdc, P _{out} = 28 W Avg., I _{DQ} = 1200 mA, f ₁ = 2112.5 MHz, f ₂ = 2122.5 MHz and f ₁ = 2157.5 MHz, f ₂ = 2167.5 MHz; IM3 measured over 3.84 MHz BW at f ₁ -10 MHz and f ₂ +10 MHz referenced to carrier channel power.)	IM3	—	-37	-35	dBc
Adjacent Channel Power Ratio (V _{DD} = 28 Vdc, P _{out} = 28 W Avg., I _{DQ} = 1200 mA, f ₁ = 2112.5 MHz, f ₂ = 2122.5 MHz and f ₁ = 2157.5 MHz, f ₂ = 2167.5 MHz; ACPR measured over 3.84 MHz at f ₁ -5 MHz and f ₂ +5 MHz.)	ACPR	—	-39	-37	dBc
Input Return Loss (V _{DD} = 28 Vdc, P _{out} = 28 W Avg., I _{DQ} = 1200 mA, f ₁ = 2112.5 MHz, f ₂ = 2122.5 MHz and f ₁ = 2157.5 MHz, f ₂ = 2167.5 MHz)	IRL	—	-12	-9	dB

(1) Part is internally matched both on input and output.

Freescale Semiconductor, Inc.

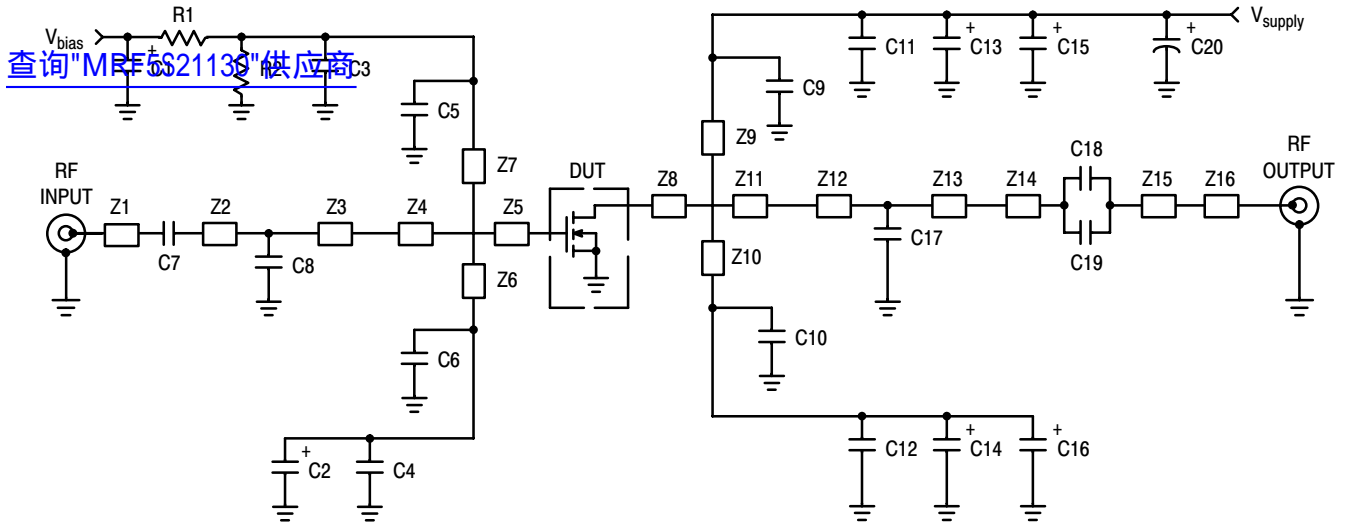

Z1	0.500" x 0.083" Microstrip	Z9, Z10	0.709" x 0.083" Microstrip
Z2	0.995" x 0.083" Microstrip	Z11	0.415" x 1.000" Microstrip
Z3	0.905" x 0.083" Microstrip	Z12	0.531" x 0.083" Microstrip
Z4	0.159" x 1.024" Microstrip	Z13	0.994" x 0.083" Microstrip
Z5	0.117" x 1.024" Microstrip	Z14, Z15	0.070" x 0.220" Microstrip
Z6, Z7	0.749" x 0.083" Microstrip	Z16	0.430" x 0.083" Microstrip
Z8	0.117" x 1.000" Microstrip	PCB	Taconic TLX8, 0.030", $\epsilon_r = 2.55$

Figure 1. MRF5S21130 Test Circuit Schematic

Table 1. MRF5S21130 Test Circuit Component Designations and Values

Part	Description	Value, P/N or DWG	Manufacturer
C1, C2, C13, C14, C15, C16	10 μ F, 35 V Tantalum Capacitors	293D1106X9035D	Vishay - Sprague
C3, C4, C11, C12	220 nF Chip Capacitors (1812)	1812Y224KXA	Vishay - Vitramon
C5, C6, C7, C9, C10, C18, C19	6.8 pF 100B Chip Capacitors	100B6R8CW	ATC
C8	0.1 pF 100B Chip Capacitor	100B0R1BW	ATC
C17	0.5 pF 100B Chip Capacitor	100B0R5BW	ATC
C20	220 μ F, 63 V Electrolytic Capacitor, Radial	13668221	Philips
R1, R2	1 k Ω , 1/4 W Chip Resistors		

[查询"MRF5S21130"供应商](#)

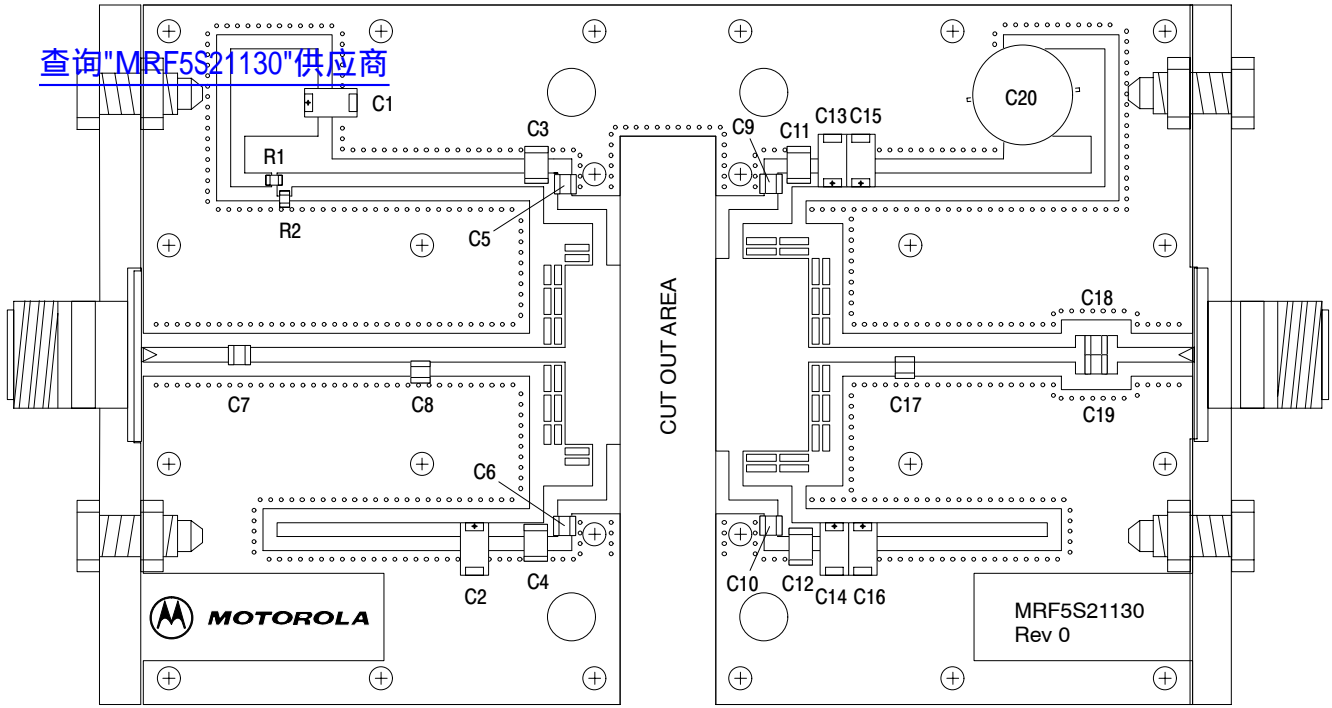

Figure 2. MRF5S21130 Test Circuit Component Layout

ARCHIVE INFORMATION

ARCHIVE INFORMATION

TYPICAL CHARACTERISTICS

查询"MRF5S21130"供应商

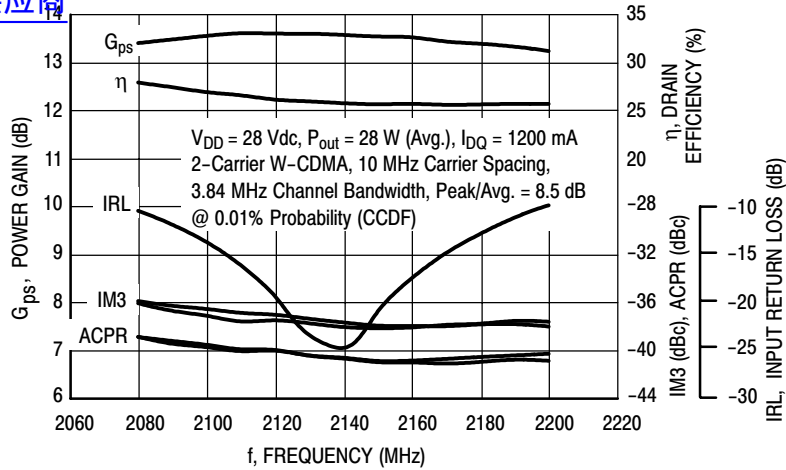

Figure 3. 2-Carrier W-CDMA Broadband Performance

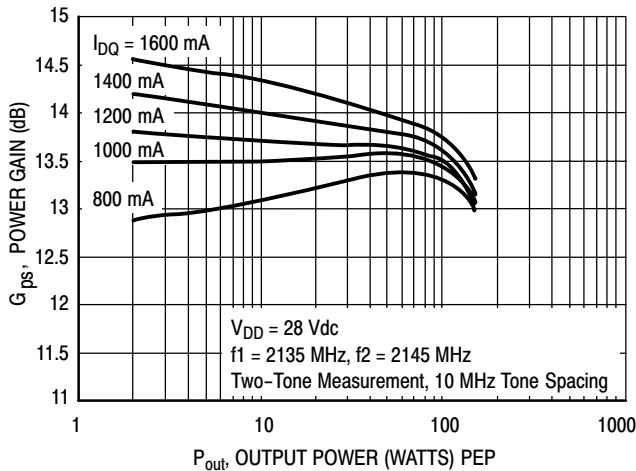

Figure 4. Two-Tone Power Gain versus Output Power

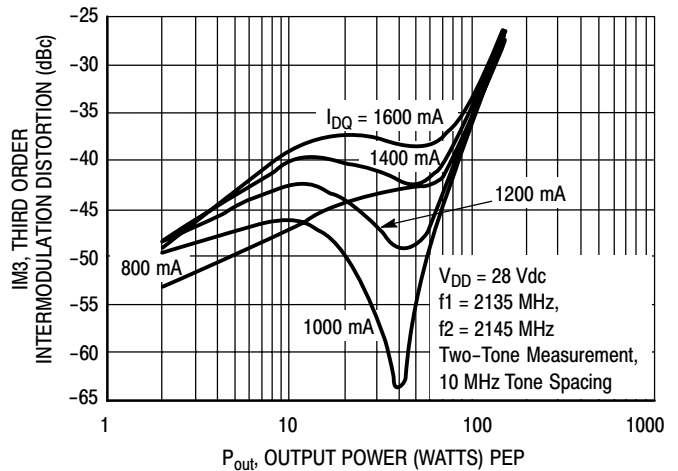

Figure 5. Third Order Intermodulation Distortion versus Output Power

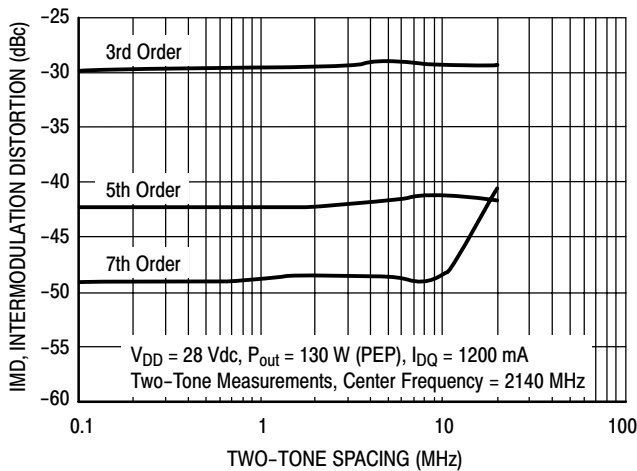

Figure 6. Intermodulation Distortion Products versus Tone Spacing

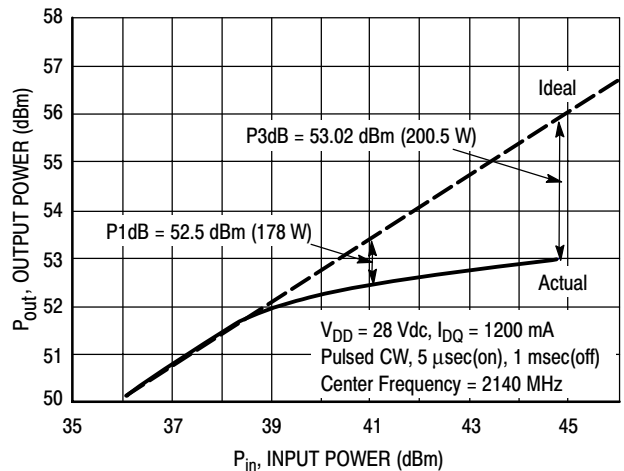

Figure 7. Pulse CW Output Power versus Input Power

Freescale Semiconductor, Inc. ARCHIVE INFORMATION

ARCHIVE INFORMATION

TYPICAL CHARACTERISTICS

[查询"MRF5S21130"供应商](#)

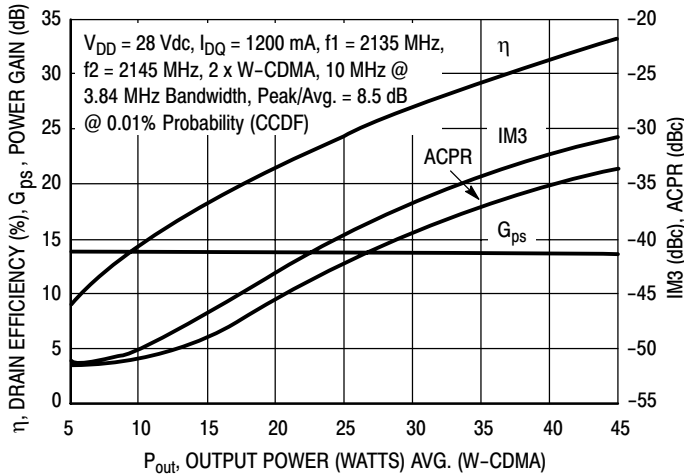

Figure 8. 2-Carrier W-CDMA ACPR, IM3, Power Gain and Drain Efficiency versus Output Power

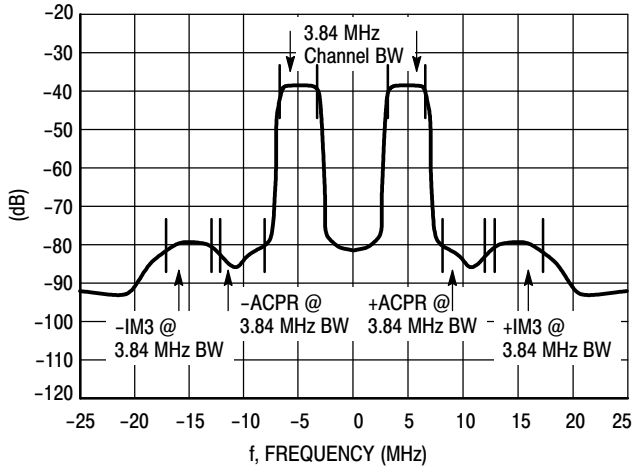

Figure 9. 2-Carrier W-CDMA Spectrum

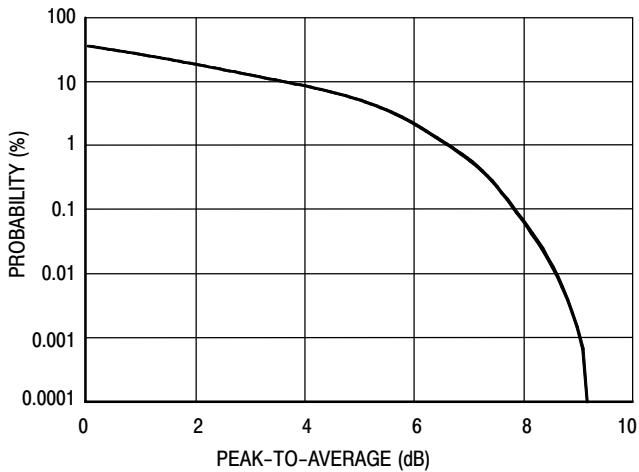
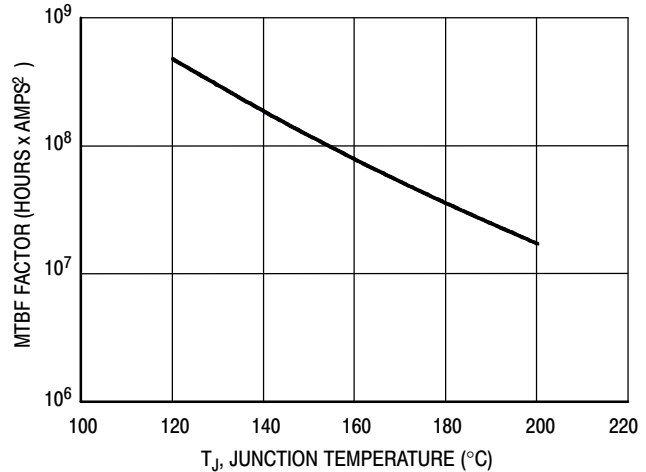

Figure 10. CCDF W-CDMA 3GPP, Test Model 1, 64 DPCH, 67% Clipping, Single Carrier Test Signal



This above graph displays calculated MTBF in hours x ampere² drain current. Life tests at elevated temperatures have correlated to better than $\pm 10\%$ of the theoretical prediction for metal failure. Divide MTBF factor by I_D^2 for MTBF in a particular application.

Figure 11. MTBF Factor versus Junction Temperature

查询"MRF5S21130R3"供应商

Freescale Semiconductor, Inc.
ARCHIVE INFORMATION

ARCHIVE INFORMATION

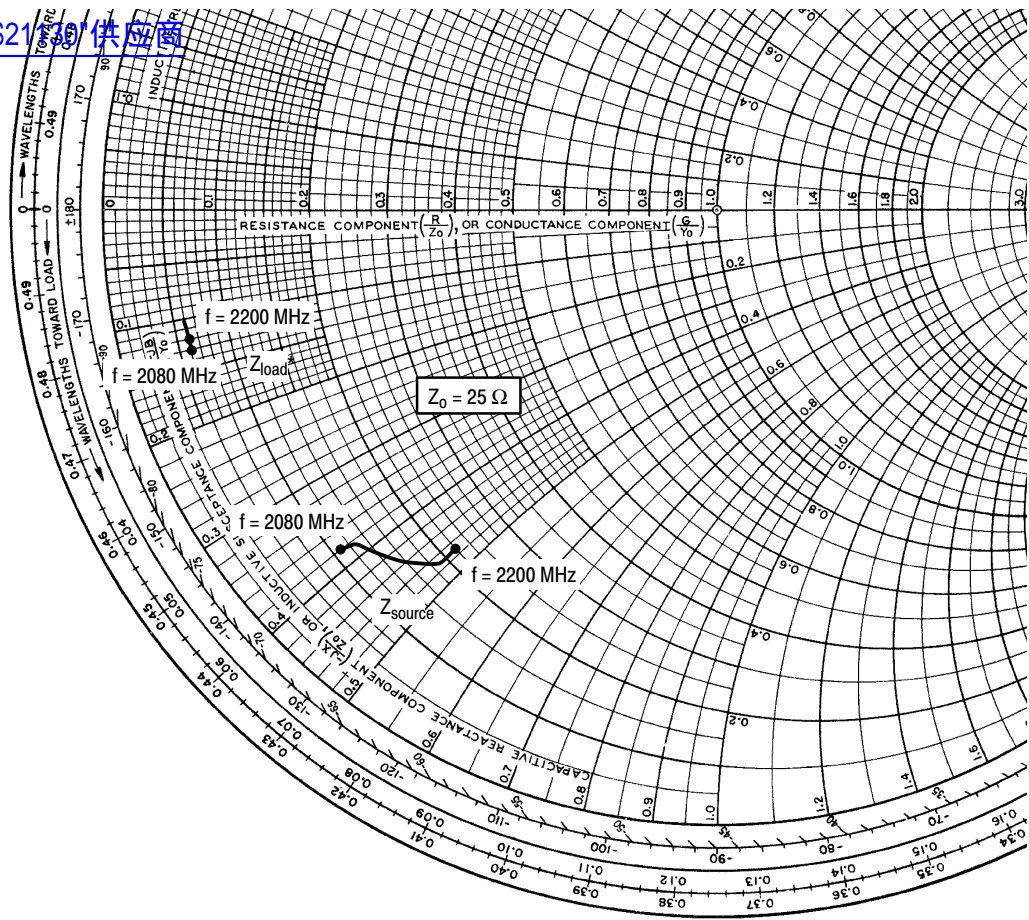

$V_{DD} = 28 \text{ Vdc}$, $I_{DQ} = 1200 \text{ mA}$, $P_{out} = 28 \text{ W Avg.}$

f MHz	Z_{source} Ω	Z_{load} Ω
2080	$2.87 - j9.49$	$1.51 - j2.97$
2110	$3.13 - j9.86$	$1.52 - j2.54$
2140	$4.05 - j10.90$	$1.59 - j2.68$
2170	$4.80 - j11.75$	$1.62 - j2.70$
2200	$5.55 - j11.87$	$1.54 - j3.13$

Z_{source} = Test circuit impedance as measured from gate to ground.

Z_{load} = Test circuit impedance as measured from drain to ground.

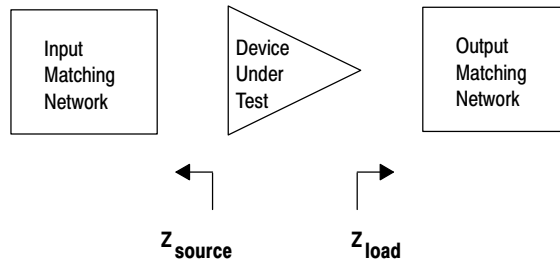

Figure 12. Series Equivalent Input and Output Impedance

NOTES

[查询"MRF5S21130"供应商](#)

ARCHIVE INFORMATION

ARCHIVE INFORMATION

NOTES

[查询"MRF5S21130"供应商](#)

Freescale Semiconductor, Inc.
ARCHIVE INFORMATION

ARCHIVE INFORMATION

NOTES

[查询"MRF5S21130"供应商](#)

ARCHIVE INFORMATION

ARCHIVE INFORMATION

Freescale Semiconductor, Inc.

PACKAGE DIMENSIONS

查询"MRF5S21130"供应商

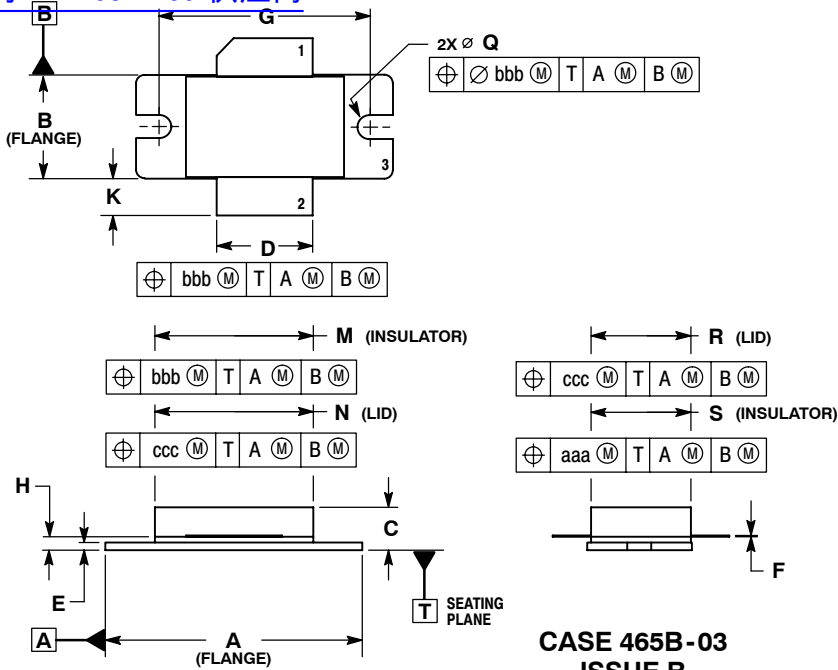

- NOTES:
1. DIMENSIONING AND TOLERANCING PER ANSI Y14.5M-1994.
 2. CONTROLLING DIMENSION: INCH.
 3. DIMENSION H IS MEASURED 0.030 (0.762) AWAY FROM PACKAGE BODY.
 4. DELETED

DIM	INCHES		MILLIMETERS	
	MIN	MAX	MIN	MAX
A	1.335	1.345	33.91	34.16
B	0.535	0.545	13.6	13.8
C	0.147	0.200	3.73	5.08
D	0.495	0.505	12.57	12.83
E	0.035	0.045	0.89	1.14
F	0.003	0.006	0.08	0.15
G	1.100 BSC		27.94 BSC	
H	0.057	0.067	1.45	1.70
K	0.170	0.210	4.32	5.33
M	0.872	0.888	22.15	22.55
N	0.871	0.889	19.30	22.60
Q	\varnothing 0.118	\varnothing 0.138	\varnothing 3.00	\varnothing 3.51
R	0.515	0.525	13.10	13.30
S	0.515	0.525	13.10	13.30
aaa	0.007 REF		0.178 REF	
bbb	0.010 REF		0.254 REF	
ccc	0.015 REF		0.381 REF	

- STYLE 1:
1. DRAIN
 2. GATE
 3. SOURCE

CASE 465B-03
ISSUE B
NI-880
MRF5S21130R3

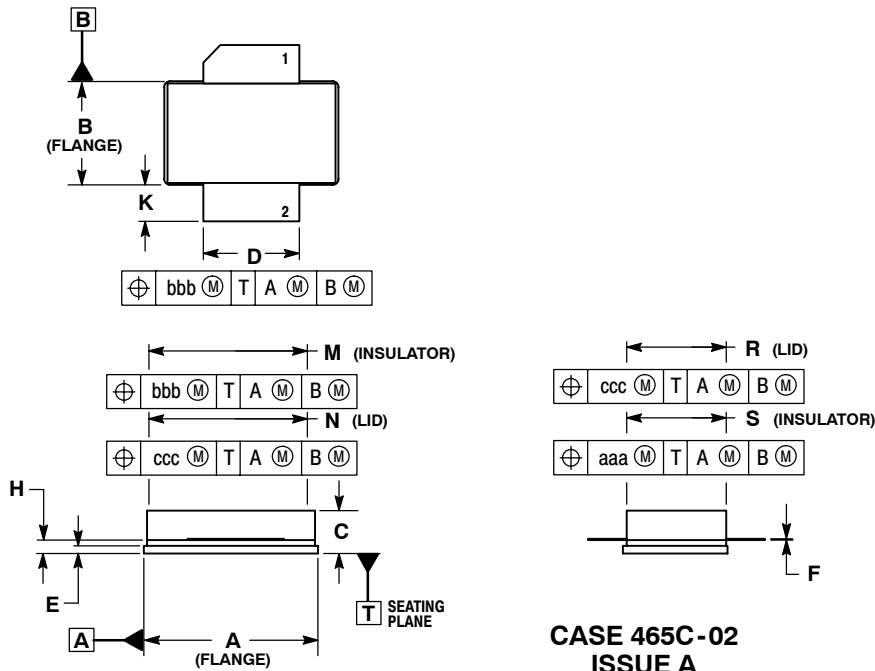

- NOTES:
1. DIMENSIONING AND TOLERANCING PER ANSI Y14.5M-1994.
 2. CONTROLLING DIMENSION: INCH.
 3. DIMENSION H IS MEASURED 0.030 (0.762) AWAY FROM PACKAGE BODY.

DIM	INCHES		MILLIMETERS	
	MIN	MAX	MIN	MAX
A	0.905	0.915	22.99	23.24
B	0.535	0.545	13.60	13.80
C	0.147	0.200	3.73	5.08
D	0.495	0.505	12.57	12.83
E	0.035	0.045	0.89	1.14
F	0.003	0.006	0.08	0.15
H	0.057	0.067	1.45	1.70
K	0.170	0.210	4.32	5.33
M	0.872	0.888	22.15	22.55
N	0.871	0.889	19.30	22.60
R	0.515	0.525	13.10	13.30
S	0.515	0.525	13.10	13.30
aaa	0.007 REF		0.178 REF	
bbb	0.010 REF		0.254 REF	
ccc	0.015 REF		0.381 REF	

- STYLE 1:
1. DRAIN
 2. GATE
 3. SOURCE

CASE 465C-02
ISSUE A
NI-880S
MRF5S21130SR3

[查询"MRF5S21130"供应商](#)

ARCHIVE INFORMATION

ARCHIVE INFORMATION

Information in this document is provided solely to enable system and software implementers to use Motorola products. There are no express or implied copyright licenses granted hereunder to design or fabricate any integrated circuits or integrated circuits based on the information in this document.

Motorola reserves the right to make changes without further notice to any products herein. Motorola makes no warranty, representation or guarantee regarding the suitability of its products for any particular purpose, nor does Motorola assume any liability arising out of the application or use of any product or circuit, and specifically disclaims any and all liability, including without limitation consequential or incidental damages. "Typical" parameters that may be provided in Motorola data sheets and/or specifications can and do vary in different applications and actual performance may vary over time. All operating parameters, including "Typicals", must be validated for each customer application by customer's technical experts. Motorola does not convey any license under its patent rights nor the rights of others. Motorola products are not designed, intended, or authorized for use as components in systems intended for surgical implant into the body, or other applications intended to support or sustain life, or for any other application in which the failure of the Motorola product could create a situation where personal injury or death may occur. Should Buyer purchase or use Motorola products for any such unintended or unauthorized application, Buyer shall indemnify and hold Motorola and its officers, employees, subsidiaries, affiliates, and distributors harmless against all claims, costs, damages, and expenses, and reasonable attorney fees arising out of, directly or indirectly, any claim of personal injury or death associated with such unintended or unauthorized use, even if such claim alleges that Motorola was negligent regarding the design or manufacture of the part.

MOTOROLA and the Stylized M Logo are registered in the US Patent and Trademark Office. All other product or service names are the property of their respective owners. Motorola, Inc. is an Equal Opportunity/Affirmative Action Employer.

© Motorola Inc. 2004

HOW TO REACH US:

USA/EUROPE/LOCATIONS NOT LISTED:
Motorola Literature Distribution
P.O. Box 5405, Denver, Colorado 80217
1-800-521-6274 or 480-768-2130

JAPAN: Motorola Japan Ltd.; SPS, Technical Information Center,
3-20-1, Minami-Azabu, Minato-ku, Tokyo 106-8573, Japan
81-3-3440-3569

ASIA/PACIFIC: Motorola Semiconductors H.K. Ltd.; Silicon Harbour Centre,
2 Dai King Street, Tai Po Industrial Estate, Tai Po, N.T., Hong Kong
852-26668334

HOME PAGE: <http://motorola.com/semiconductors>



MOTOROLA

**For More Information On This Product,
Go to: www.freescale.com**

MRF5S21130/D