



# LP5521 Programmable Three Channel LED Driver

## General Description

The LP5521 is a three channel LED driver designed to produce variety of lighting effects for mobile devices. High efficiency charge pump enables LED driving over full Li-Ion battery voltage range. The device has a program memory for creating variety of lighting sequences. When program memory has been loaded, LP5521 can operate independently without processor control.

LP5521 maintains excellent efficiency over a wide operating range by automatically selecting proper charge pump gain based on LED forward voltage requirements. LP5521 is able to automatically enter power-save mode, when LED outputs are not active and thus lowering current consumption.

Three independent LED channels have accurate programmable current sources and PWM control. Each channel has program memory for creating desired lighting sequences with PWM control.

LP5521 has a flexible digital interface. Trigger I/O and 32 kHz clock input allow synchronization between multiple devices. Interrupt output can be used to notify processor, when LED sequence has ended. LP5521 has four pin selectable I<sup>2</sup>C addresses. This allows connecting up to four parallel devices in one I<sup>2</sup>C bus. GPO and INT pins can be used as a digital control pin for other devices.

LP5521 requires only four small and low cost ceramic capacitors.

LP5521 is available in tiny 2.1x1.7x0.6 mm microSMD-20 package and in 4.0x5.0x0.8 mm bumped LLP-24 package.

Comprehensive application tools are available, including command compiler for easy LED sequence programming.

## Features

- Adaptive charge pump with 1x and 1.5x gain provides up to 95% LED drive efficiency
- Charge pump with soft start and overcurrent/short circuit protection
- Low input ripple and EMI
- Very small solution size, no inductor or resistors required
- 200 nA typical shutdown current
- Automatic power save mode
- I<sup>2</sup>C compatible interface
- Independently programmable constant current outputs with 8-bit current setting and 8-bit PWM control
- Typical LED output saturation voltage 50 mV and current matching 1%
- Three program execution engines with flexible instruction set
- Autonomous operation without external control
- Large SRAM program memory
- Two general purpose digital outputs
- microSMD-20 package, 0.4 mm pitch
- Bumped LLP-24 package, 0.5 mm pitch

## Applications

- Fun / indicator lights
- LCD sub-display backlighting
- Keypad RGB backlighting and phone cosmetics
- Vibra, speakers, waveform generator

## Typical Application

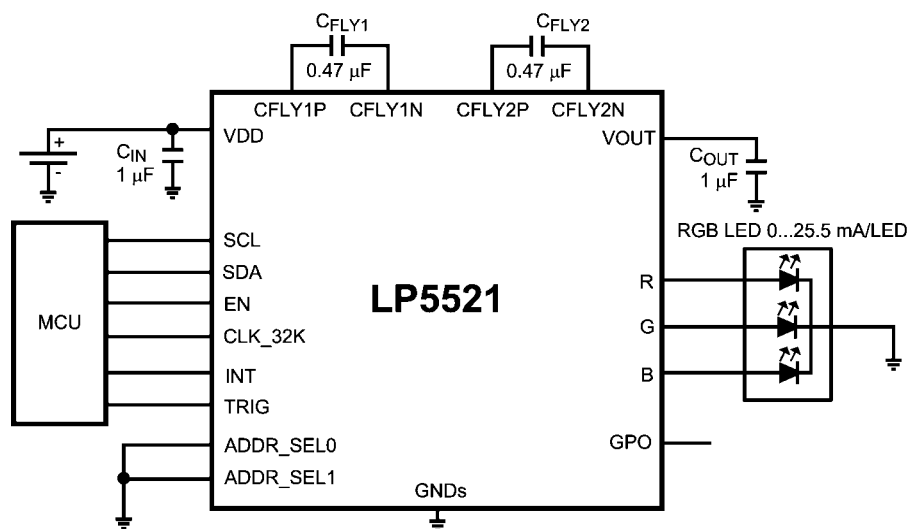

20186270

# Connection Diagrams and Package Mark Information

[查询"LP5521TM"供应商](#)

Thin microSMD-20 Package (2.1 x 1.7 x 0.6 mm, 0.4 mm pitch)  
NS Package Number TMD20ECA

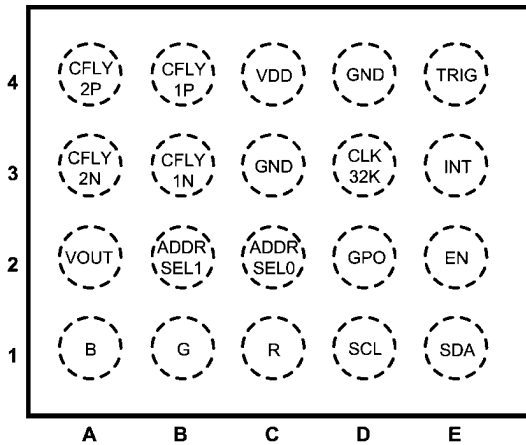

Top View

20186271

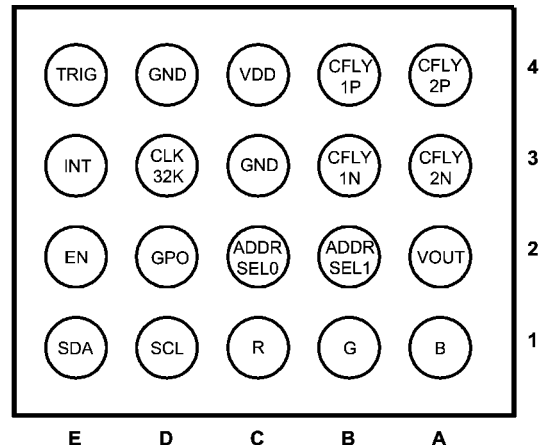

Bottom View

20186272

## Package Mark

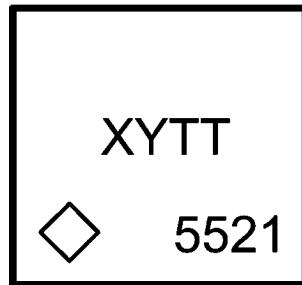

XY = 2 Digit Date Code

TT = Die Traceability

5521 = Product Identification

= Pin 1A

Package Mark - Top View

20186296

# Connection Diagrams and Package Mark Information

[查询"LP5521TM"供应商](#)

Bumped LLP-24 Package (5 x 4 x 0.8 mm, 0.5 mm pitch)

NS Package Number YQA24A

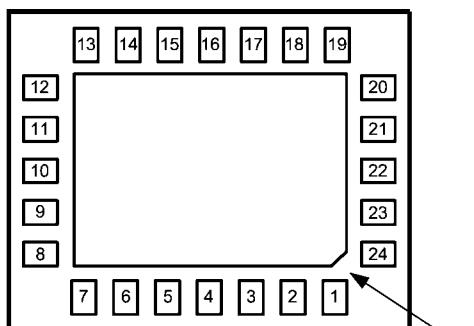

Pin 1

20186202

Bottom View

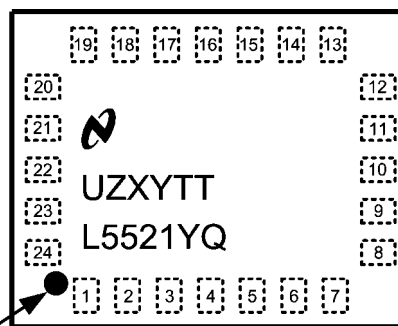

Pin 1

20186201

Package Mark - Top View

U = Fab  
 Z = Assembly  
 XY = 2 Digit Date Code  
 TT = Die Traceability  
 L5521YQ = Product Identification

## Ordering Information

Order Number	Package	Package Marking	Supplied As	Spec/Flow
LP5521TM	μSMD	5521	250 units, Tape-and-Reel	NoPb
LP5521TM X	μSMD	5521	3000 units, Tape-and-Reel	NoPb
LP5521YQ	bumped LLP	L5521YQ	1000 units, Tape-and-Reel	NoPb
LP5521YQ X	bumped LLP	L5521YQ	4500 units, Tape-and-Reel	NoPb

## Pin Descriptions LP5521TM

[查询"LP5521TM"供应商](#)

Pin #	Name	Type	Description
1A	B	A	Current source output
1B	G	A	Current source output
1C	R	A	Current source output
1D	SCL	I	I <sup>2</sup> C Serial interface clock input
1E	SDA	I/OD	I <sup>2</sup> C Serial interface data input/output
2A	VOUT	A	Charge pump output
2B	ADDR_SEL1	I	I <sup>2</sup> C address select input
2C	ADDR_SEL0	I	I <sup>2</sup> C address select input
2D	GPO	O	General purpose output
2E	EN	I	Chip enable
3A	CFLY2N	A	Negative terminal of charge pump fly capacitor 2
3B	CFLY1N	A	Negative terminal of charge pump fly capacitor 1
3C	GND	G	Ground
3D	CLK_32K	I	32 kHz clock input
3E	INT	OD/O	Interrupt output / General Purpose Output
4A	CFLY2P	A	Positive terminal of charge pump fly capacitor 2
4B	CFLY1P	A	Positive terminal of charge pump fly capacitor 1
4C	VDD	P	Power supply pin
4D	GND	G	Ground
4E	TRIG	I/OD	Trigger input/output

**A: Analog Pin, G: Ground Pin, P: Power Pin, I: Input Pin, I/O: Input/Output Pin, O: Output Pin, OD: Open Drain Pin**

## Pin Descriptions LP5521YQ

[查询"LP5521TM"供应商](#)

Pin #	Name	Type	Description
1	CFLY2P	A	Positive terminal of charge pump fly capacitor 2
2	CFLY1P	A	Positive terminal of charge pump fly capacitor 1
3	VDD	P	Power supply pin
4	GND	G	Ground
5	CLK_32K	I	32 kHz clock input
6	INT	OD/O	Interrupt output / General purpose output
7	TRIG	I/OD	Trigger input/output
8		N/C	
9		N/C	
10		N/C	
11		N/C	
12		N/C	
13	SDA	I/OD	I <sup>2</sup> C Serial interface data input/output
14	EN	I	Chip enable
15	SCL	I	I <sup>2</sup> C Serial interface clock input
16	GPO	O	General purpose output
17	R	A	Current source output
18	G	A	Current source output
19	B	A	Current source output
20	ADDR_SEL0	I	I <sup>2</sup> C address select input
21	ADDR_SEL1	I	I <sup>2</sup> C address select input
22	VOUT	A	Charge pump output
23	CFLY2N	A	Negative terminal of charge pump fly capacitor 2
24	CFLY1N	A	Negative terminal of charge pump fly capacitor 1

**A: Analog Pin, G: Ground Pin, P: Power Pin, I: Input Pin, I/O: Input/Output Pin, O: Output Pin, OD: Open Drain Pin, N/C: Not Connected**

**Absolute Maximum Ratings** (Notes 1, 2)

查询"LP5521TM"供应商

If Military/Aerospace specified devices are required, please contact the National Semiconductor Sales Office/Distributors for availability and specifications.

$V(V_{DD}, V_{OUT}, R, G, B)$	-0.3V to +6.0V
Voltage on Logic Pins	-0.3V to $V_{DD} + 0.3V$ with 6.0V max
Continuous Power Dissipation (Note 3)	Internally Limited
Junction Temperature ( $T_{J-MAX}$ )	125°C
Storage Temperature Range	-65°C to +150°C
Maximum Lead Temperature (Soldering)	(Note 4)
ESD Rating (Note 5)	
Human Body Model:	2 kV
Machine Model:	200V

**Operating Ratings** (Notes 1, 2)

$V_{DD}$	2.7 to 5.5V
Recommended Charge Pump Load Current $I_{OUT}$	0 to 100 mA
Junction Temperature ( $T_J$ ) Range	-30°C to +125°C
Ambient Temperature ( $T_A$ ) Range (Note 6)	-30°C to +85°C

**Thermal Properties**

Junction-to-Ambient Thermal Resistance ( $\theta_{JA}$ ), TMD20 Package (Note 7)	50 - 90°C/W
Junction-to-Ambient Thermal Resistance ( $\theta_{JA}$ ), YQA24A Package (Note 7)	37 - 90°C/W

**Electrical Characteristics** (Notes 2, 8)

Limits in standard typeface are for  $T_J = 25^\circ\text{C}$ . Limits in **boldface** type apply over the operating ambient temperature range (-30°C <  $T_A$  < +85°C). Unless otherwise noted, specifications apply to the LP5521 Block Diagram with:  $2.7V \leq V_{DD} \leq 5.5V$ ,  $C_{OUT} = C_{IN} = 1 \mu\text{F}$ ,  $C_{FLY1} = C_{FLY2} = 0.47 \mu\text{F}$ . (Note 9).

Symbol	Parameter	Condition	Min	Typ	Max	Units	
$I_{VDD}$	Standby supply current	EN = 0 (pin), CHIP_EN = 0 (bit), external 32 kHz clock running or not running		0.2	<b>2</b>	$\mu\text{A}$	
		EN = 1 (pin), CHIP_EN = 0 (bit), external 32 kHz clock not running		1.0		$\mu\text{A}$	
		EN = 1 (pin), CHIP_EN = 0 (bit), external 32 kHz clock running		1.4		$\mu\text{A}$	
	Normal mode supply current	Charge pump and LED drivers disabled			0.25		mA
		Charge pump in 1x mode, no load, LED drivers disabled			0.70		mA
		Charge pump in 1.5x mode, no load, LED drivers disabled			1.5		mA
		Charge pump in 1x mode, no load, LED drivers enabled			1.2		mA
Powersave mode supply current	External 32 kHz clock running			10		$\mu\text{A}$	
	Internal oscillator running			0.25		mA	
$f_{OSC}$	Internal oscillator frequency accuracy		-4		4	%	
			<b>-7</b>		<b>7</b>		

**Charge Pump Electrical Characteristics** (Note 10)

Symbol	Parameter	Condition	Min	Typ	Max	Units
$R_{OUT}$	Charge pump output resistance	Gain = 1.5x		3.5		$\Omega$
		Gain = 1x		1		$\Omega$
$f_{SW}$	Switching frequency		<b>-7</b>	1.25	<b>7</b>	MHz %
$I_{GND}$	Ground current	Gain = 1.5x		1.2		mA
		Gain = 1x		0.5		mA
$t_{ON}$	$V_{OUT}$ turn-on time from charge pump off to 1.5x mode	$V_{DD} = 3.6V$ , CHIP_EN = H $I_{OUT} = 60 \text{ mA}$		100		$\mu\text{s}$
$V_{OUT}$	Charge pump output voltage	$V_{DD} = 3.6V$ , no load, Gain = 1.5x		4.55		V

## LED Driver Electrical Characteristics (R, G, B Outputs)

Symbol	Parameter	Condition	Min	Typ	Max	Units
$I_{LEAKAGE}$	R, G, B pin leakage current			0.1	1	$\mu A$
$I_{MAX}$	Maximum Source Current	Outputs R, G, B		25.5		mA
$I_{OUT}$	Accuracy of output current	Output current set to 17.5 mA, $V_{DD} = 3.6V$	-4 -5		4 5	%
$I_{MATCH}$	Matching (Note 11)	$I_{OUT} = 17.5 mA, V_{DD} = 3.6V$		1	2	%
$f_{LED}$	LED PWM switching frequency	PWM_HF = 1 Frequency defined by internal oscillator		558		Hz
		PWM_HF = 0 Frequency defined by 32 kHz clock (internal or external)		256		Hz
$V_{SAT}$	Saturation voltage (Note 12)	$I_{OUT}$ set to 17.5 mA		50	100	mV

## Logic Interface Characteristics

(V(EN) = 1.65V... $V_{DD}$  unless otherwise noted)

Symbol	Parameter	Conditions	Min	Typ	Max	Units
<b>LOGIC INPUT EN</b>						
$V_{IL}$	Input Low Level				0.5	V
$V_{IH}$	Input High Level		1.2			V
$I_I$	Logic Input Current		-1.0		1.0	$\mu A$
$t_{DELAY}$	Input delay			2		$\mu s$
<b>LOGIC INPUT SCL, SDA, TRIG, CLK_32K</b>						
$V_{IL}$	Input Low Level				0.2xV(EN)	V
$V_{IH}$	Input High Level		0.8xV(EN)			V
$I_I$	Input Current		-1.0		1.0	$\mu A$
$f_{CLK\_32K}$	Clock frequency			32		kHz
$f_{SCL}$	Clock frequency				400	kHz
<b>LOGIC OUTPUT SDA, TRIG, INT</b>						
$V_{OL}$	Output Low Level	$I_{OUT} = 3 mA$ (pull-up current)		0.3	0.5	V
$I_L$	Output Leakage Current				1.0	$\mu A$
<b>LOGIC INPUT ADDR_SEL0, ADDR_SEL1</b>						
$V_{IL}$	Input Low Level				0.2x $V_{DD}$	V
$V_{IH}$	Input High Level		0.8x $V_{DD}$			V
$I_I$	Input Current		-1.0		1.0	$\mu A$
<b>LOGIC OUTPUT GPO, INT (in GPO state)</b>						
$V_{OL}$	Output Low Level	$I_{OUT} = 3 mA$		0.3	0.5	V
$V_{OH}$	Output High Level	$I_{OUT} = -2 mA$	$V_{DD} - 0.5$	$V_{DD} - 0.3$		V
$I_L$	Output leakage current				1.0	$\mu A$

## I<sup>2</sup>C Timing Parameters (SDA, SCL) (Note 13)

Symbol	Parameter	Limit		Units
		Min	Max	
$f_{SCL}$	Clock Frequency		400	kHz
1	Hold Time (repeated) START Condition	0.6		$\mu$ s
2	Clock Low Time	1.3		$\mu$ s
3	Clock High Time	600		ns
4	Setup Time for a Repeated START Condition	600		ns
5	Data Hold Time	50		ns
6	Data Setup Time	100		ns
7	Rise Time of SDA and SCL	$20+0.1C_b$	300	ns
8	Fall Time of SDA and SCL	$15+0.1C_b$	300	ns
9	Set-up Time for STOP condition	600		ns
10	Bus Free Time between a STOP and a START Condition	1.3		$\mu$ s
$C_b$	Capacitive Load for Each Bus Line	10	200	pF

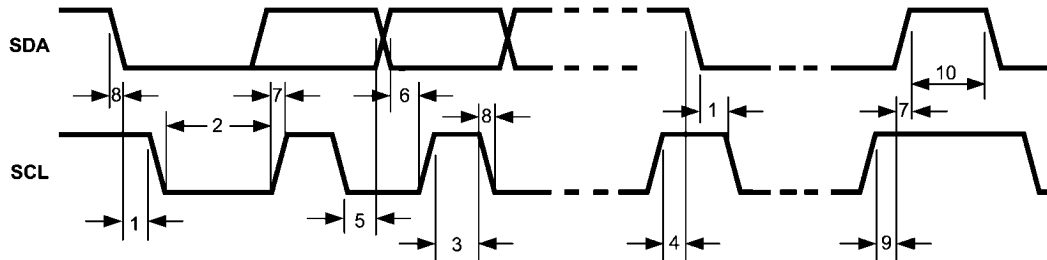

20186298

**Note 1:** Absolute Maximum Ratings indicate limits beyond which damage to the component may occur. Operating Ratings are conditions under which operation of the device is guaranteed. Operating Ratings do not imply guaranteed performance limits. For guaranteed performance limits and associated test conditions, see the Electrical Characteristics tables.

**Note 2:** All voltages are with respect to the potential at the GND pins.

**Note 3:** Internal thermal shutdown circuitry protects the device from permanent damage. Thermal shutdown engages at  $T_J = 150^\circ\text{C}$  (typ.) and disengages at  $T_J = 130^\circ\text{C}$  (typ.).

**Note 4:** For detailed soldering specifications and information, please refer to National Semiconductor Application Note AN1112 : Micro SMD Wafer Level Chip Scale Package or AN1187 : Leadless Leadframe Package (LLP).

**Note 5:** The Human body model is a 100 pF capacitor discharged through a 1.5 k $\Omega$  resistor into each pin. The machine model is a 200 pF capacitor discharged directly into each pin. MIL-STD-883 3015.7

**Note 6:** In applications where high power dissipation and/or poor package thermal resistance is present, the maximum ambient temperature may have to be derated. Maximum ambient temperature ( $T_{A-MAX}$ ) is dependent on the maximum operating junction temperature ( $T_{J-MAX-OP} = 125^\circ\text{C}$ ), the maximum power dissipation of the device in the application ( $P_{D-MAX}$ ), and the junction-to ambient thermal resistance of the part/package in the application ( $\theta_{JA}$ ), as given by the following equation:  $T_{A-MAX} = T_{J-MAX-OP} - (\theta_{JA} \times P_{D-MAX})$ .

**Note 7:** Junction-to-ambient thermal resistance is highly application and board-layout dependent. In applications where high maximum power dissipation exists, special care must be paid to thermal dissipation issues in board design.

**Note 8:** Min and Max limits are guaranteed by design, test, or statistical analysis. Typical numbers are not guaranteed, but do represent the most likely norm.

**Note 9:** Low-ESR Surface-Mount Ceramic Capacitors (MLCCs) used in setting electrical characteristics.

**Note 10:** Input, output, and fly capacitors should be of the type X5R or X7R low ESR ceramic capacitor.

**Note 11:** Matching is the maximum difference from the average of the three output's currents.

**Note 12:** Saturation voltage is defined as the voltage when the LED current has dropped 10% from the value measured at  $V_{OUT} - 1V$ .

**Note 13:** Guaranteed by design.



# Typical Performance Characteristics

Unless otherwise specified,  $V_{DD} = 3.6V$

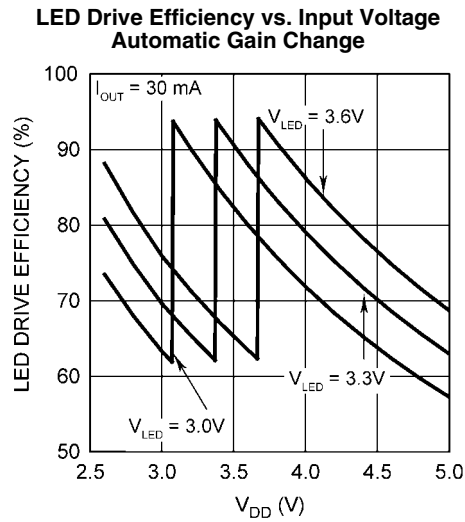

20186221

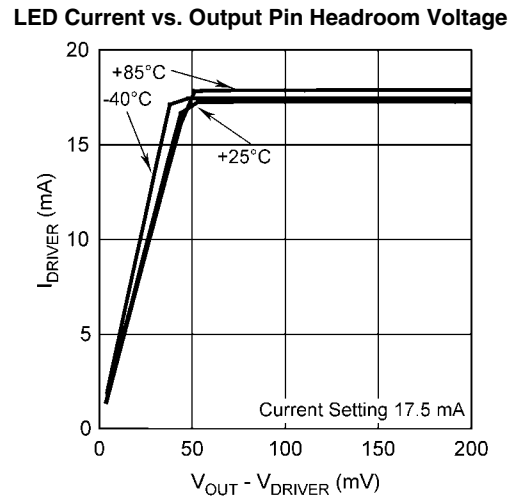

20186222

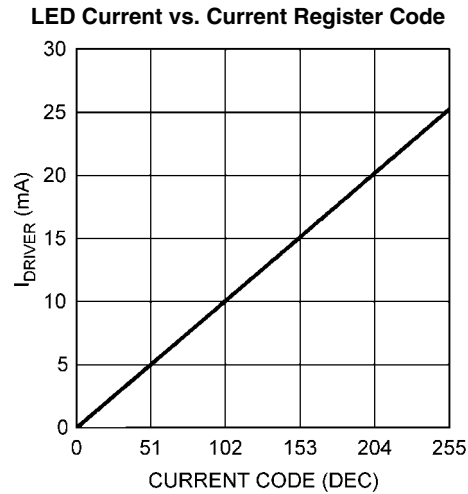

20186223

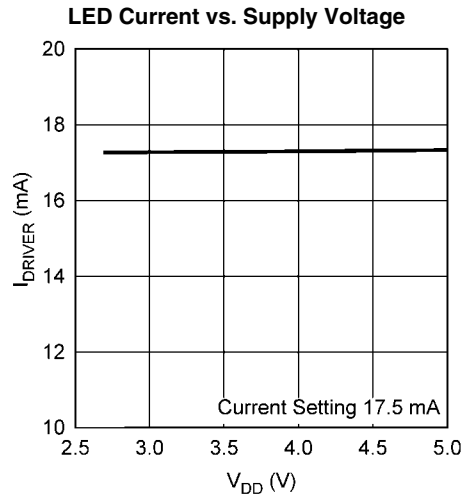

20186207

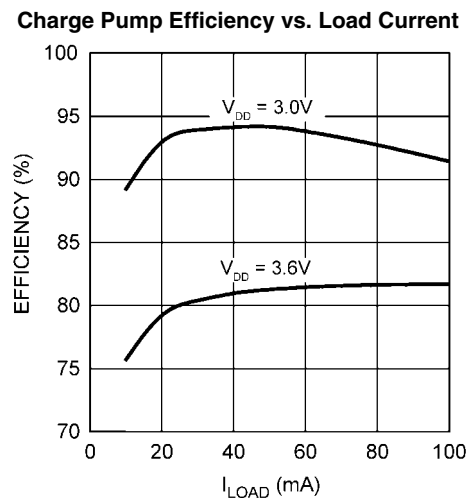

20186208

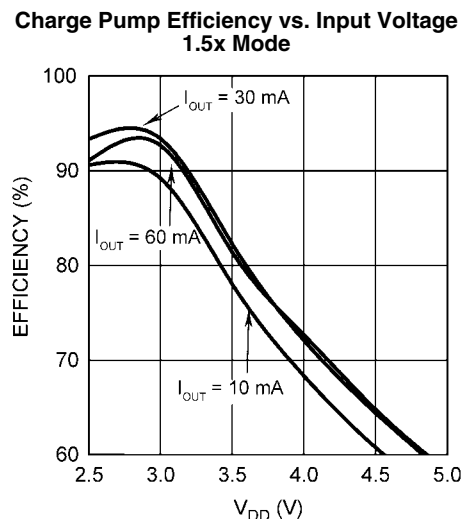

20186209

Charge Pump Output Voltage vs. Load Current  
[查询"LP5521"供应商](#)

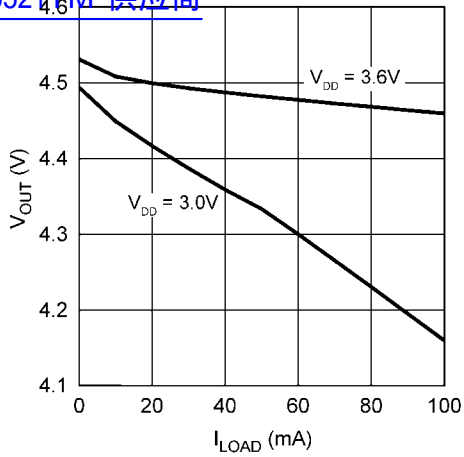

20186210

Charge Pump Output Voltage vs. Input Voltage  
 Automatic Gain Change from 1x to 1.5x

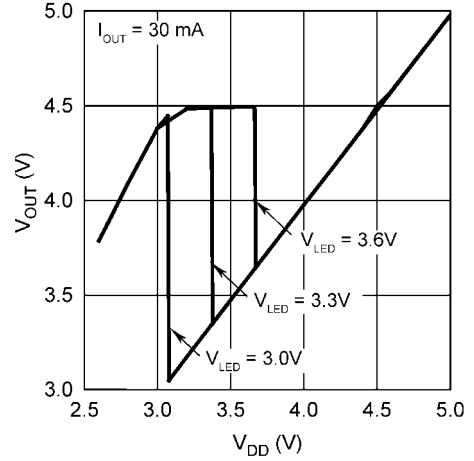

20186211

Charge Pump Automatic Gain Change Hysteresis

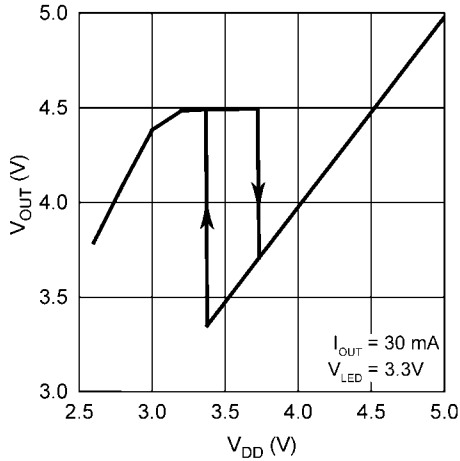

20186212

Charge Pump Startup in 1.5x Mode  
 No Load

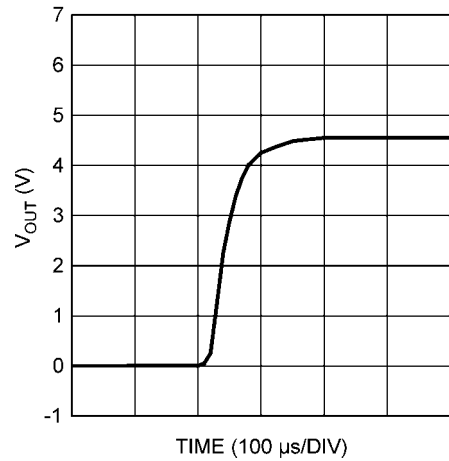

20186213

Charge Pump Load Transient Response  
 in 1.5x Mode (0 to 25.5 mA)

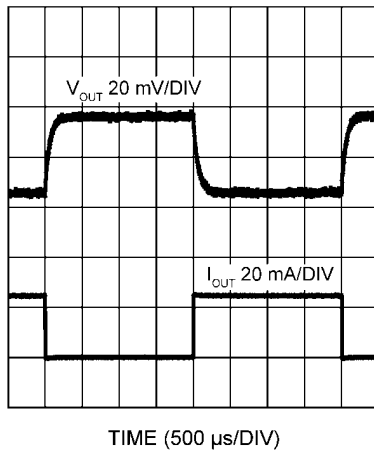

20186214

Charge Pump Line Transient Response  
 1.5x Mode (V\_IN 3.5V to 4.0V)

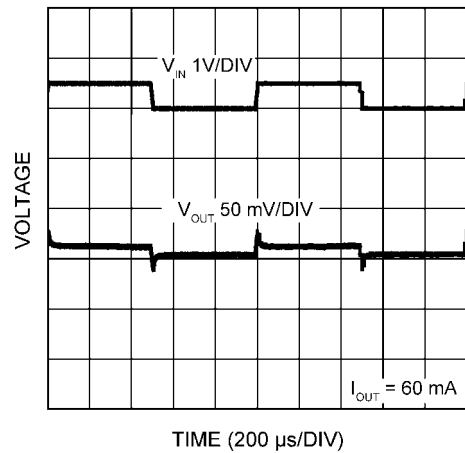

20186215

Charge Pump Automatic Gain Change (LED  $V_F = 3.6V$ )

[查询"LP5521TM"供应商](#)

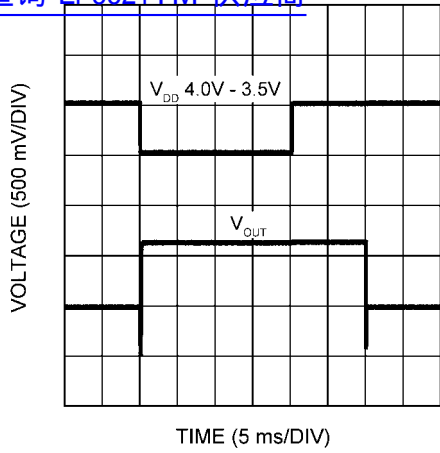

20186216

Standby Current vs. Input Voltage

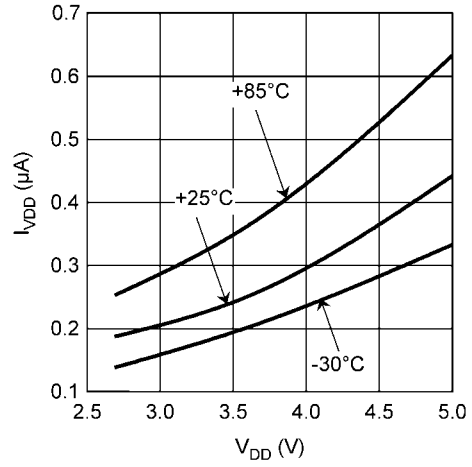

20186217

For full LP5521 datasheet please contact nearest National Semiconductor sales office.

**Physical Dimensions** inches (millimeters) unless otherwise noted  
[查询"LP5521TM"供应商](#)

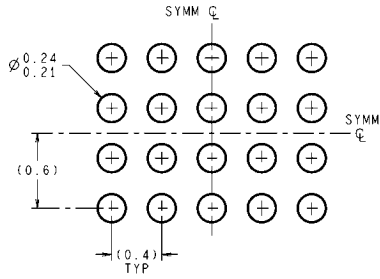

**LAND PATTERN RECOMMENDATION**

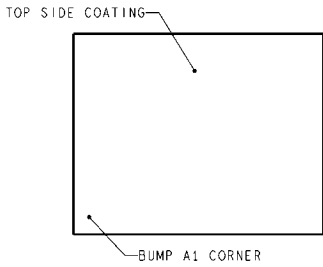

**DIMENSIONS ARE IN MILLIMETERS**  
 DIMENSIONS IN ( ) FOR REFERENCE ONLY

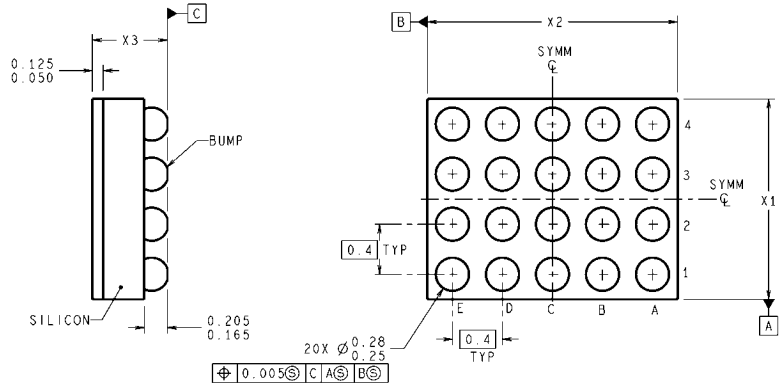

TMD20XXX (Rev D)

The dimension for X1 ,X2 and X3 are as given:

- X1=1.717 mm ± 0.03 mm
- X2=2.066 mm ± 0.03 mm
- X3=0.600 mm ± 0.075 mm

**TMD20ECA: Thin microSMD-20, Small Bump**

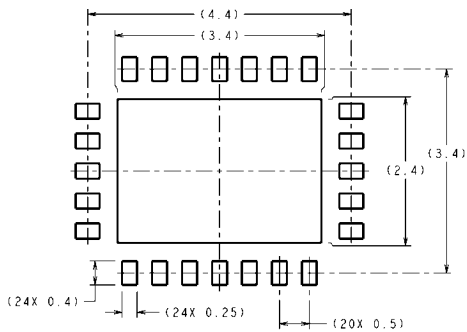

**RECOMMENDED LAND PATTERN**  
 1:1 RATIO WITH PKG SOLDER PADS

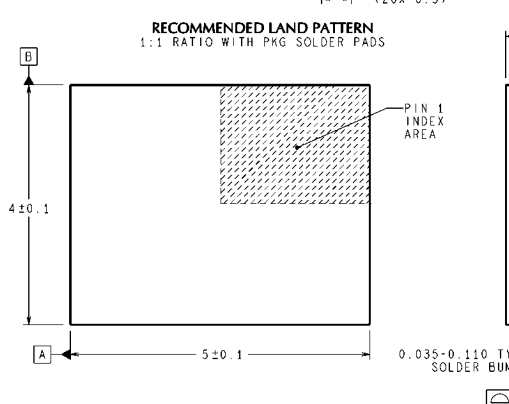

**DIMENSIONS ARE IN MILLIMETERS**  
 DIMENSIONS IN ( ) FOR REFERENCE ONLY

**YQA24A: Bumped LLP-24**

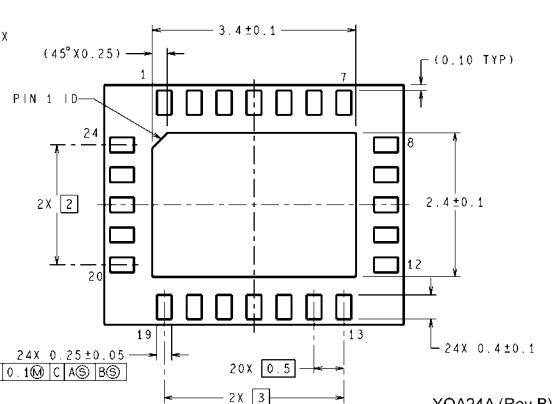

YQA24A (Rev B)

## Notes

[查询"LP5521TM"供应商](#)

## Notes

THE CONTENTS OF THIS DOCUMENT ARE PROVIDED IN CONNECTION WITH NATIONAL SEMICONDUCTOR CORPORATION ("NATIONAL") PRODUCTS. NATIONAL MAKES NO REPRESENTATIONS OR WARRANTIES WITH RESPECT TO THE ACCURACY OR COMPLETENESS OF THE CONTENTS OF THIS PUBLICATION AND RESERVES THE RIGHT TO MAKE CHANGES TO SPECIFICATIONS AND PRODUCT DESCRIPTIONS AT ANY TIME WITHOUT NOTICE. NO LICENSE, WHETHER EXPRESS, IMPLIED, ARISING BY ESTOPPEL OR OTHERWISE, TO ANY INTELLECTUAL PROPERTY RIGHTS IS GRANTED BY THIS DOCUMENT.

TESTING AND OTHER QUALITY CONTROLS ARE USED TO THE EXTENT NATIONAL DEEMS NECESSARY TO SUPPORT NATIONAL'S PRODUCT WARRANTY. EXCEPT WHERE MANDATED BY GOVERNMENT REQUIREMENTS, TESTING OF ALL PARAMETERS OF EACH PRODUCT IS NOT NECESSARILY PERFORMED. NATIONAL ASSUMES NO LIABILITY FOR APPLICATIONS ASSISTANCE OR BUYER PRODUCT DESIGN. BUYERS ARE RESPONSIBLE FOR THEIR PRODUCTS AND APPLICATIONS USING NATIONAL COMPONENTS. PRIOR TO USING OR DISTRIBUTING ANY PRODUCTS THAT INCLUDE NATIONAL COMPONENTS, BUYERS SHOULD PROVIDE ADEQUATE DESIGN, TESTING AND OPERATING SAFEGUARDS.

EXCEPT AS PROVIDED IN NATIONAL'S TERMS AND CONDITIONS OF SALE FOR SUCH PRODUCTS, NATIONAL ASSUMES NO LIABILITY WHATSOEVER, AND NATIONAL DISCLAIMS ANY EXPRESS OR IMPLIED WARRANTY RELATING TO THE SALE AND/OR USE OF NATIONAL PRODUCTS INCLUDING LIABILITY OR WARRANTIES RELATING TO FITNESS FOR A PARTICULAR PURPOSE, MERCHANTABILITY, OR INFRINGEMENT OF ANY PATENT, COPYRIGHT OR OTHER INTELLECTUAL PROPERTY RIGHT.

### LIFE SUPPORT POLICY

**NATIONAL'S PRODUCTS ARE NOT AUTHORIZED FOR USE AS CRITICAL COMPONENTS IN LIFE SUPPORT DEVICES OR SYSTEMS WITHOUT THE EXPRESS PRIOR WRITTEN APPROVAL OF THE CHIEF EXECUTIVE OFFICER AND GENERAL COUNSEL OF NATIONAL SEMICONDUCTOR CORPORATION.** As used herein:

Life support devices or systems are devices which (a) are intended for surgical implant into the body, or (b) support or sustain life and whose failure to perform when properly used in accordance with instructions for use provided in the labeling can be reasonably expected to result in a significant injury to the user. A critical component is any component in a life support device or system whose failure to perform can be reasonably expected to cause the failure of the life support device or system or to affect its safety or effectiveness.

National Semiconductor and the National Semiconductor logo are registered trademarks of National Semiconductor Corporation. All other brand or product names may be trademarks or registered trademarks of their respective holders.

Copyright© 2007 National Semiconductor Corporation

For the most current product information visit us at [www.national.com](http://www.national.com)



**National Semiconductor  
Americas Customer  
Support Center**  
Email:  
[new.feedback@nsc.com](mailto:new.feedback@nsc.com)  
Tel: 1-800-272-9959

**National Semiconductor Europe  
Customer Support Center**  
Fax: +49 (0) 180-530-85-86  
Email: [europe.support@nsc.com](mailto:europe.support@nsc.com)  
Deutsch Tel: +49 (0) 69 9508 6208  
English Tel: +49 (0) 870 24 0 2171  
Français Tel: +33 (0) 1 41 91 8790

**National Semiconductor Asia  
Pacific Customer Support Center**  
Email: [ap.support@nsc.com](mailto:ap.support@nsc.com)

**National Semiconductor Japan  
Customer Support Center**  
Fax: 81-3-5639-7507  
Email: [jpn.feedback@nsc.com](mailto:jpn.feedback@nsc.com)  
Tel: 81-3-5639-7560