

Ethernet DC/DC Converter EPC1008P & EPC1008H

[查询"EPC1008H"供应商](#)

- Features**
- 75 % Typical efficiency at full load @ nominal input voltage
 - Unregulated Output
 - Input / Output Isolation
 - Input filter to reduce input ripple current
 - Designed for low common mode noise

Electrical Specifications

*Note : Package with G = Surface Mount Device, †† : E1,E1-G,E4,E4-G,E11,Q,Q1, N4-G

PCA P/N	STD PKG	Optional Packages	Input Voltage V	Output Voltage V	Output Current mA Max.	Output Ripple & Noise @ 20 MHz BW mV p-p	Isolation Vrms
EPC1008P	E	E-G*, F2,N,††	12.0	9 ± 5%	200 Max.	100 Max.	500
EPC1008H	E1	E1-G*,N,Q1	12.0	9 ± 5%	200 Max.	100 Max.	2000

Pin Connections for E**

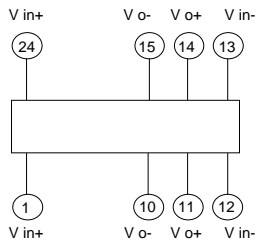

Pin Connections for E1

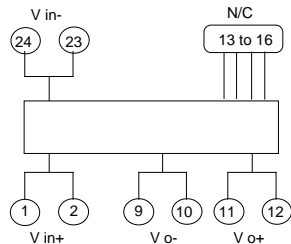

Pin Connections for E4

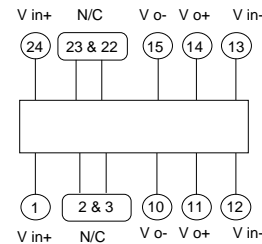

Pin Connections for F2

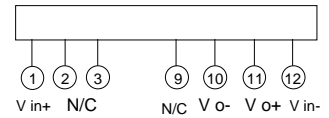

PACKAGE E

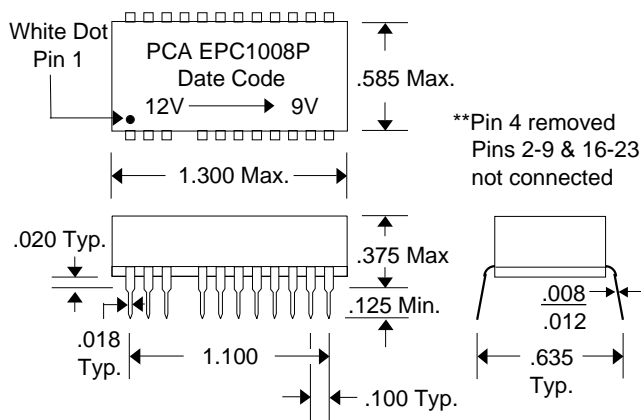

PACKAGE F2

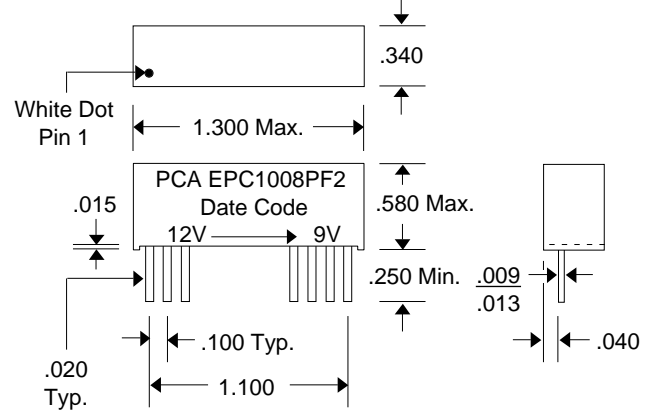

PACKAGE E1

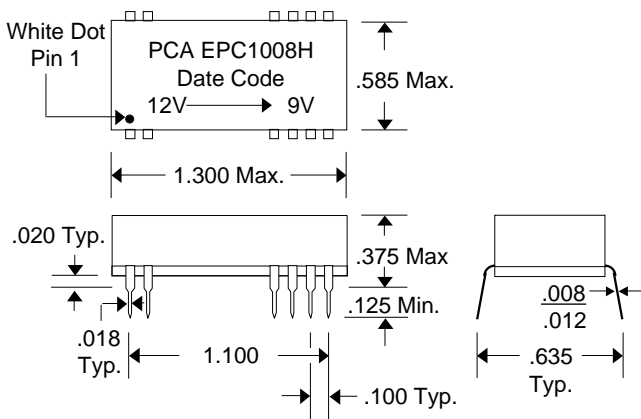

PACKAGE E4

