

International **IOR** Rectifier

40HF(R) SERIES

STANDARD RECOVERY DIODES

Stud Version

Features

- High surge current capability
- Stud cathode and stud anode version
- Leaded version available
- Types up to 1600V V_{RRM}

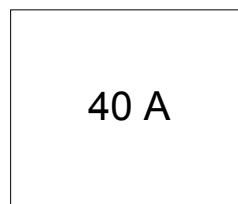

Typical Applications

- Battery charges
- Converters
- Power supplies
- Machine tool controls
- Welding

Major Ratings and Characteristics

Parameters	40HF(R)		Units
	10 to 120	140, 160	
$I_{F(AV)}$	40	40	A
@ T_C	140	110	°C
$I_{F(RMS)}$	62		A
I_{FSM}	@ 50Hz	570	A
	@ 60Hz	595	A
i^2t	@ 50Hz	1600	A ² s
	@ 60Hz	1450	A ² s
V_{RRM} range	100 to 1200	1400, 1600	V
T_J range	- 65 to 190	- 65 to 160	°C



40HF(R) Series

Bulletin I20201 rev. C 03/04



ELECTRICAL SPECIFICATIONS

Voltage Ratings

Type number	Voltage Code	V_{RRM} , maximum repetitive peak reverse voltage V	V_{RSM} , maximum non-repetitive peak reverse voltage V	I_{RRM} max. @ $T_J = T_{J\ max}$. mA
40HF(R)	10	100	200	9
	20	200	300	
	40	400	500	
	60	600	700	
	80	800	900	
	100	1000	1100	
	120	1200	1300	
	140	1400	1500	4.5
160	1600	1700		

Forward Conduction

Parameter	40HF(R)		Units	Conditions				
	10 to 120	140, 160						
$I_{F(AV)}$ Max. average forward current @ Case temperature	40	40	A	180° conduction, half sine wave				
	140	110	°C					
$I_{F(RMS)}$ Max. RMS forward current	62		A	Sinusoidal half wave, Initial $T_J = T_{J\ max}$.				
I_{FSM} Max. peak, one-cycle forward, non-repetitive surge current	570		A				t = 10ms	No voltage reappplied
	595						t = 8.3ms	
	480						t = 10ms	100% V_{RRM} reappplied
	500						t = 8.3ms	
I^2t Maximum I^2t for fusing	1600		A ² s				t = 10ms	No voltage reappplied
	1450						t = 8.3ms	
	1150						t = 10ms	100% V_{RRM} reappplied
	1050			t = 8.3ms				
I^2vt Maximum I^2vt for fusing	16000		A ² /s	t = 0.1 to 10ms, no voltage reappplied				
$V_{F(TO)}$ Value of threshold voltage (up to 1200V)	0.65		V	$T_J = T_{J\ max}$.				
$V_{F(TO)}$ Value of threshold voltage (for 1400V, 1600V)	0.76		V	$T_J = T_{J\ max}$.				
r_f Value of forward slope resistance (up to 1200V)	4.29		mΩ	$T_J = T_{J\ max}$.				
r_f Value of forward slope resistance (for 1400V, 1600V)	3.8			$T_J = T_{J\ max}$.				
V_{FM} Max. forward voltage drop	1.30	1.50	V	$I_{pk} = 125A, T_J = 25^\circ C, t_p = 400\mu s$ rectangular wave				

Thermal and Mechanical Specifications

Parameter	40HF(R)		Units	Conditions
	10 to 120	140 to 160		
T _J Max. junction operating temperature range	-65 to 190	-65 to 160	°C	
T _{stg} Max. storage temperature range	-65 to 190	-65 to 160		
R _{thJC} Max. thermal resistance, junction to case	0.95		K/W	DC operation
R _{thCS} Max. thermal resistance, case to heatsink	0.25			Mounting surface, smooth, flat and greased
T Max. allowed mounting torque ±10%	2.3 - 3.4		Nm	Not lubricated threads
	20 - 30		lbf · in	
wt Approximate weight	17 (0.6)		g (oz)	unleaded device
Case style	DO-203AB (DO5)			See Outline Table

ΔR_{thJC} Conduction

(The following table shows the increment of thermal resistance R_{thJC} when devices operate at different conduction angles than DC)

Conduction angle	Sinusoidal conduction	Rectangular conduction	Units	Conditions
180°	0.14	0.10	K/W	T _J = T _J max.
120°	0.16	0.17		
90°	0.21	0.22		
60°	0.30	0.31		
30°	0.50	0.50		

Ordering Information Table

Device Code

40	HF	R	160	M
①	②	③	④	⑤

- 1** - 40 = Standard device
41 = Not isolated lead
42 = Isolated lead with silicone sleeve
(Red = Reverse polarity)
(Blue = Normal polarity)
- 2** - Standard diode
- 3** - None = Stud Normal Polarity (Cathode to Stud)
R = Stud Reverse Polarity (Anode to Stud)
- 4** - Voltage code: Code x 10 = V_{RRM} (See Voltage Ratings table)
- 5** - None = Stud base DO-203AB (DO-5) 1/4" 28UNF-2A
M = Stud base DO-203AB (DO-5) M6 X 1

40HF(R) Series

Bulletin I20201 rev. C 03/04

Outlines Table

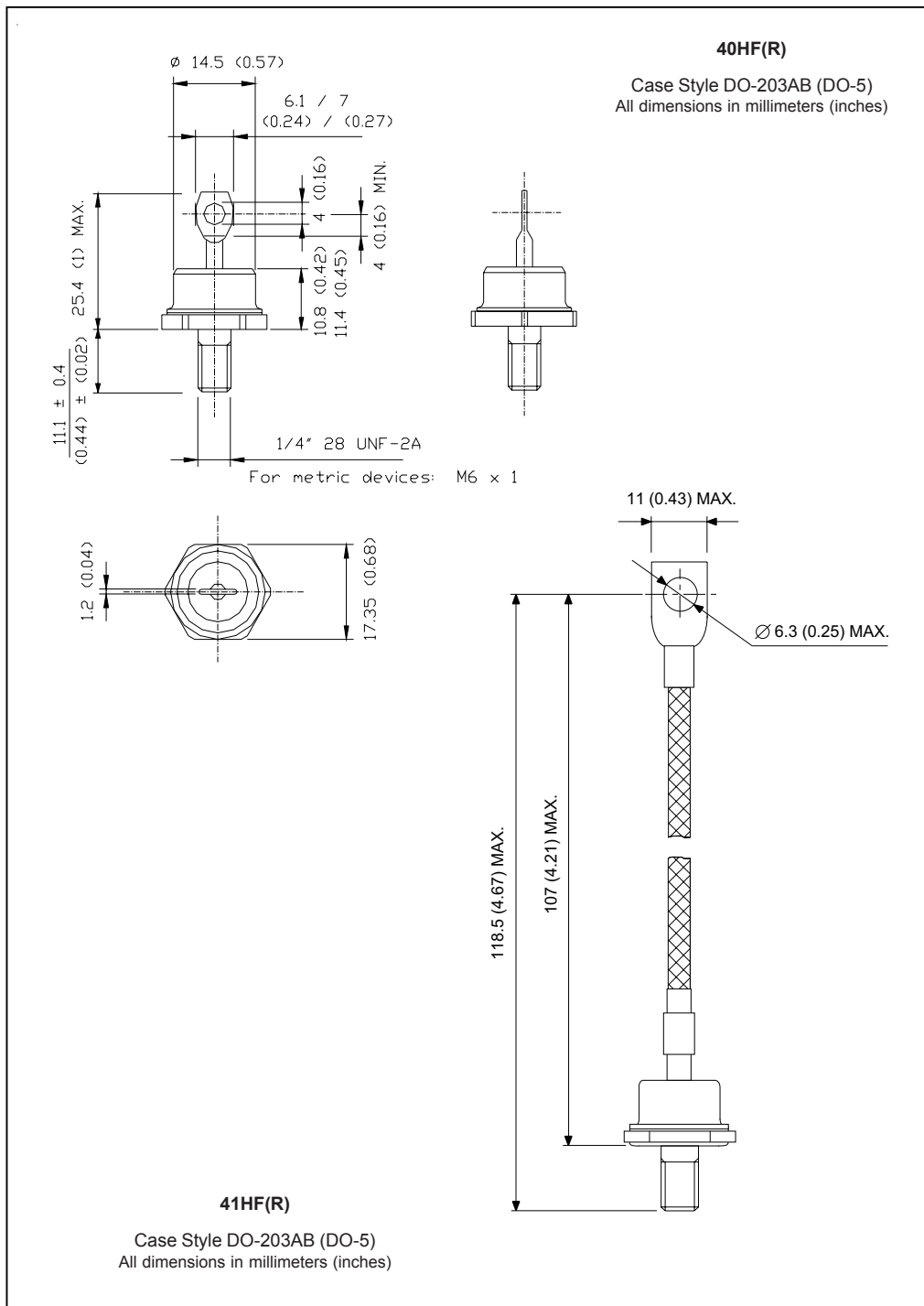

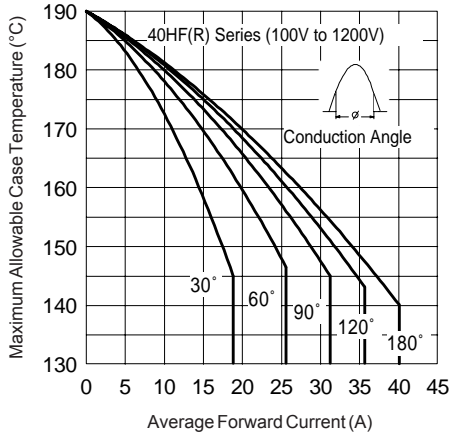

Fig. 1 - Current Ratings Characteristics

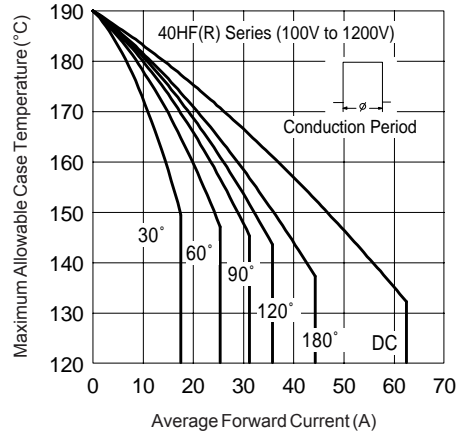

Fig. 2 - Current Ratings Characteristics

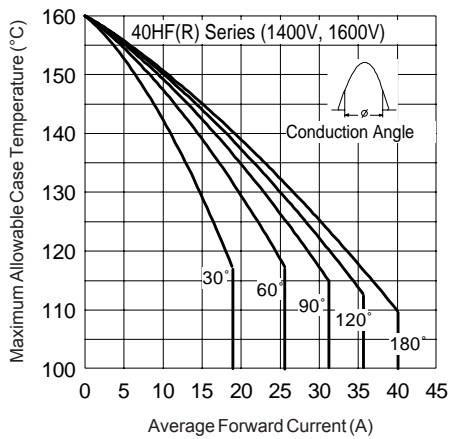

Fig. 3 - Current Ratings Characteristics

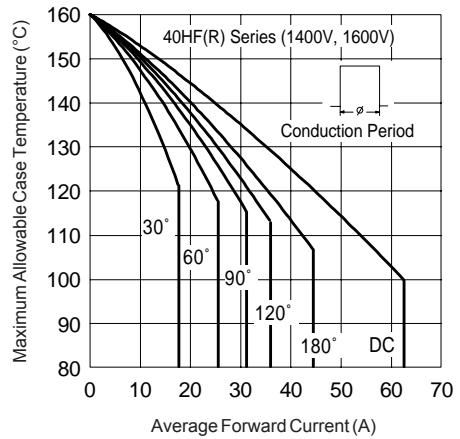

Fig. 4 - Current Ratings Characteristics

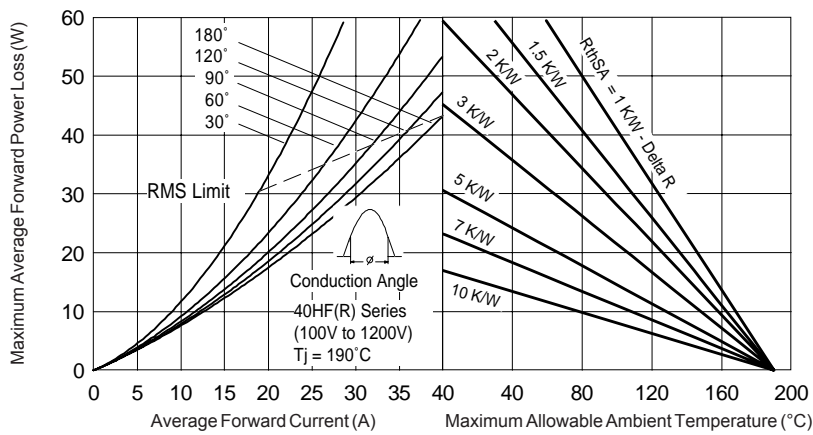

Fig. 5 - Forward Power Loss Characteristics

40HF(R) Series

Bulletin I20201 rev. C 03/04

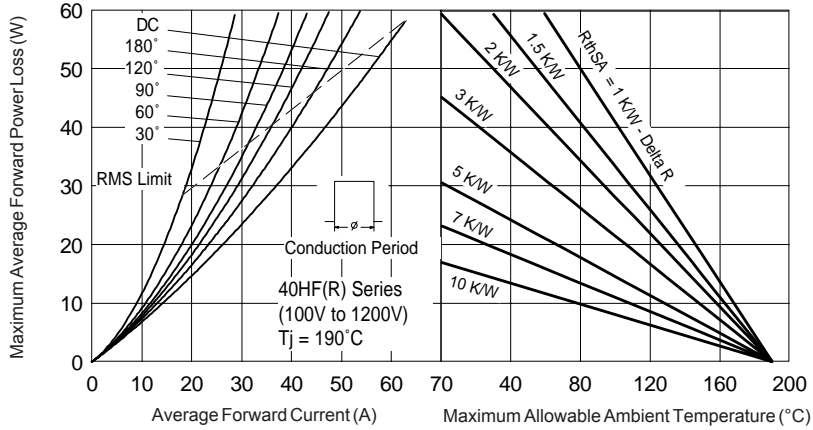

Fig. 6 - Forward Power Loss Characteristics

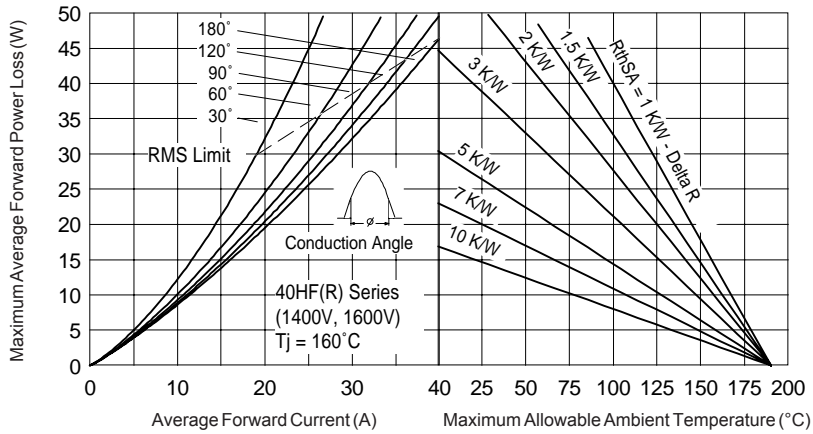

Fig. 7 - Forward Power Loss Characteristics

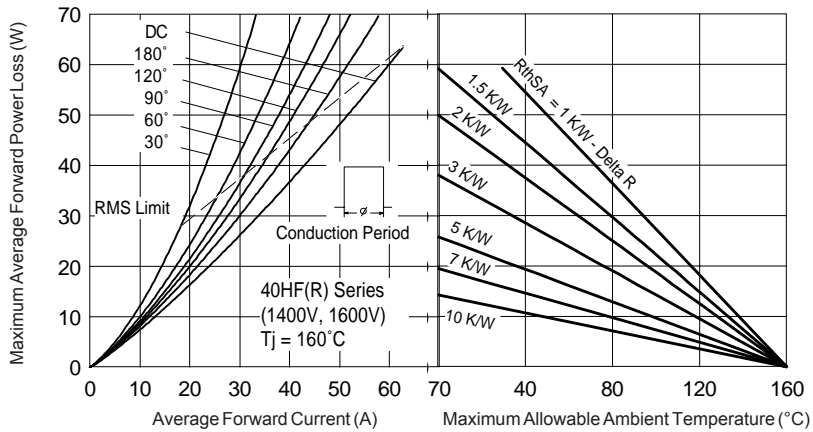

Fig. 8 - Forward Power Loss Characteristics

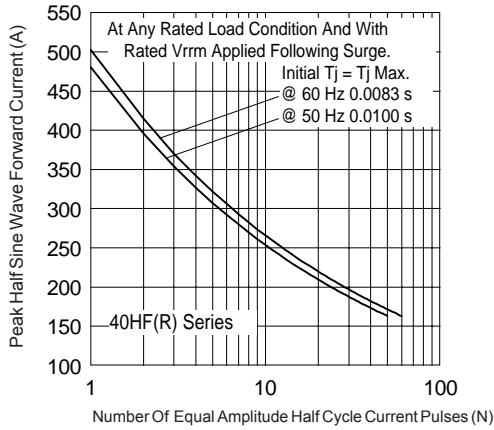

Fig. 9 - Maximum Non-Repetitive Surge Current

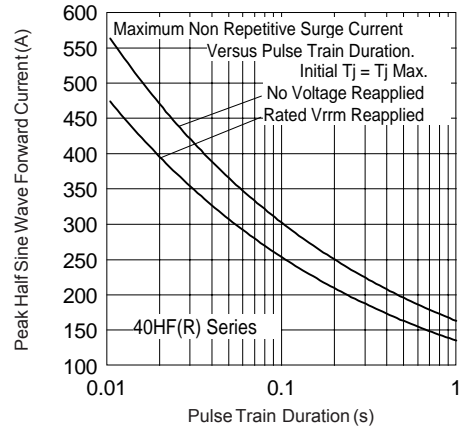

Fig. 10 - Maximum Non-Repetitive Surge Current

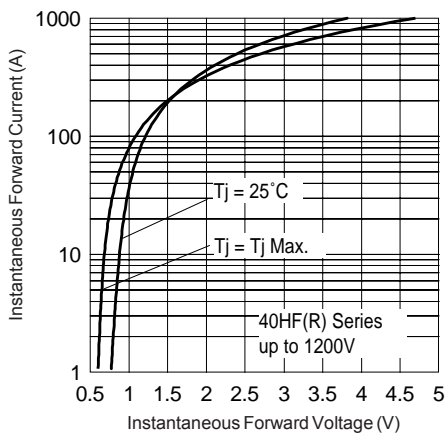

Fig. 11 - Forward Voltage Drop Characteristics (up to 1200V)

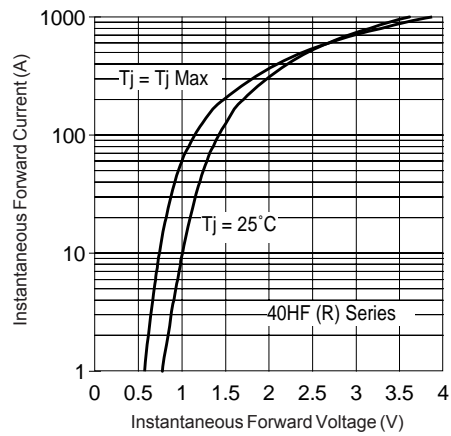

Fig. 12 - Forward Voltage Drop Characteristics (for 1400V, 1600V)

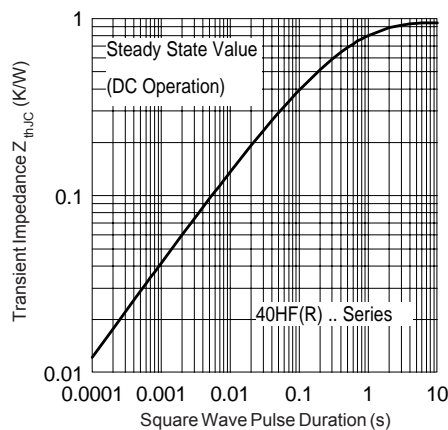

Fig. 13 - Thermal Impedance $Z_{th,jc}$ Characteristics

40HF(R) Series

Bulletin I20201 rev. C 03/04

International
IOR Rectifier

Data and specifications subject to change without notice.
This product has been designed and qualified for Industrial Level.
Qualification Standards can be found on IR's Web site.

International
IOR Rectifier

IR WORLD HEADQUARTERS: 233 Kansas St., El Segundo, California 90245, USA Tel: (310) 252-7105
TAC Fax: (310) 252-7309
Visit us at www.irf.com for sales contact information. 03/04

This datasheet has been downloaded from:

www.EEworld.com.cn

Free Download

Daily Updated Database

100% Free Datasheet Search Site

100% Free IC Replacement Search Site

Convenient Electronic Dictionary

Fast Search System

www.EEworld.com.cn