

General Description

The MIC4574 is a series of easy to use fixed and adjustable BiCMOS step-down (buck) switch-mode voltage regulators. The 200kHz MIC4574 duplicates the pinout and function of the 52kHz LM2574. The higher switching frequency may allow up to a 2:1 reduction in output filter inductor size.

The MIC4574 is available in 3.3V, and 5V fixed output versions or a 1.23V to 20V adjustable output version. Both versions are capable of driving a 0.5A load with excellent line and load regulation.

The feedback voltage is guaranteed to $\pm 2\%$ tolerance for adjustable versions, and the output voltage is guaranteed to $\pm 3\%$ for fixed versions, within specified voltages and load conditions. The oscillator frequency is guaranteed to $\pm 10\%$.

In shutdown mode, the regulator draws less than 200 μ A standby current. The regulator performs cycle-by-cycle current limiting and thermal shutdown for protection under fault conditions.

This series of simple switch-mode regulators requires a minimum number of external components and can operate using a standard series of inductors. Frequency compensation is provided internally.

The MIC4574 is available in DIP (N) and SOIC (WM) packages for the industrial temperature range.

Features

- Fixed 200kHz operation
- 3.3V, 5V, and adjustable output versions
- Voltage over specified line and load conditions:
 - Fixed version: $\pm 3\%$ max. output voltage
 - Adjustable version: $\pm 2\%$ max. feedback voltage
- Guaranteed 0.5A switch current
- Wide 4V to 24V input voltage range
- Wide 1.23V to 20V output voltage range
- Requires minimum external components
- < 200 μ A typical shutdown mode
- 75% efficiency (adjustable version > 75% typ.)
- Standard inductors and capacitors are 25% of typical LM2574 values
- Thermal shutdown
- Overcurrent protection
- 100% electrical thermal limit burn-in

Applications

- Simple high-efficiency step-down (buck) regulator
- Efficient preregulator for linear regulators
- On-card switching regulators
- Positive-to-negative converter (inverting buck-boost)
- Isolated flyback converter using minimum external components
- Negative boost converter

Typical Applications

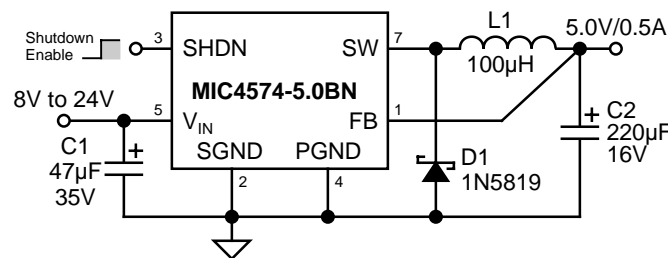

Fixed Regulator

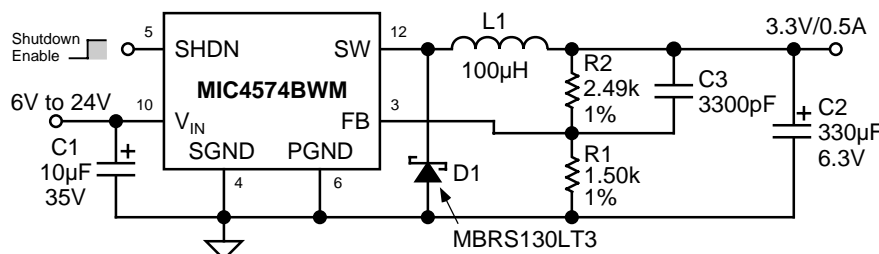

Adjustable Regulator

Ordering Information

[查询“MIC4574”供应商](#)

Part Number	Voltage	Temperature Range	Package
MIC4574-3.3BN	3.3V	-40°C to +85°C	8-pin DIP
MIC4574-5.0BN	5.0V	-40°C to +85°C	8-pin DIP
MIC4574BN	Adjustable	-40°C to +85°C	8-pin DIP
MIC4574-3.3BWM	3.3V	-40°C to +85°C	14-lead SOIC
MIC4574-5.0BWM	5.0V	-40°C to +85°C	14-lead SOIC
MIC4574BWM	Adjustable	-40°C to +85°C	14-lead SOIC

Pin Configuration

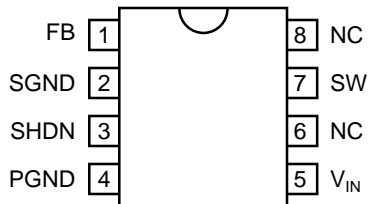

8-Pin DIP (N)

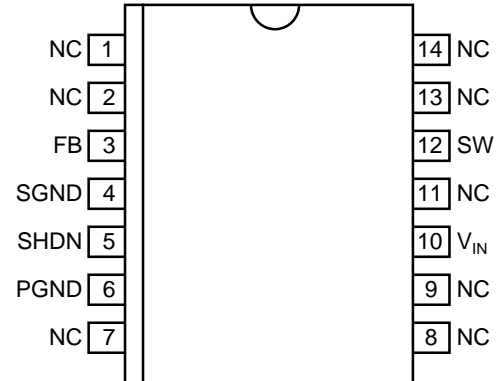

14-Lead Wide SOIC (WM)

Pin Description

Pin Number N Package	Pin Number WM Package	Pin Name	Pin Function
	1	NC	Not internally connected. Solder to printed circuit for maximum heat transfer.
	2	NC	Not internally connected. Solder to printed circuit for maximum heat transfer.
1	3	FB	Feedback (Input): Output voltage feedback to regulator. Connect to output of supply for fixed versions. Connect to 1.23V tap of resistive divider for adjustable versions.
2	4	SGND	Signal Ground
3	5	SHDN	Shutdown (Input): Logic low enables regulator. Logic high (> 2.4V) shuts down regulator.
4	6	PGND	Power Ground
	7	NC	Not internally connected. Solder to printed circuit for maximum heat transfer.
	8	NC	Not internally connected. Solder to printed circuit for maximum heat transfer.
	9	NC	Not internally connected. Solder to printed circuit for maximum heat transfer.
5	10	V _{IN}	Supply Voltage (Input): Unregulated +4V to +24V supply voltage.
	11	NC	Not internally connected. Solder to printed circuit for maximum heat transfer.
7	12	SW	Switch (Output): Emitter of NPN output switch. Connect to external storage inductor and Shottky diode.
8	13	NC	Not internally connected. Solder to printed circuit for maximum heat transfer.
	14	NC	Not internally connected. Solder to printed circuit for maximum heat transfer.

Absolute Maximum Ratings

Supply Voltage (V_{IN}) Note 1 查询MIC4574 供应商	+40V
Shutdown (V_{SHDN})	-0.3V to +36V
Output Switch (V_{SW}) steady state	-1V
Junction Temperature (T_J)	+150°C
Storage Temperature	-65°C to +150°C

Operating Ratings

Supply Voltage (V_{IN})	+24V
Package Thermal Resistance	
θ_{JA} Plastic DIP	130°C/W
θ_{JC} SOIC	120°C/W

Electrical Characteristics

$V_{IN} = 12V$; $I_{LOAD} = 100mA$; $T_A = 25^\circ C$, **bold** values indicate $-40^\circ C \leq T_A \leq +85^\circ C$; unless noted

Parameter	Condition	Min	Typ	Max	Units
MIC4574 [Adjustable]					
Feedback Voltage		1.217	1.230	1.243	V
Feedback Voltage	$8V \leq V_{IN} \leq 24V$, $0.1A \leq I_{LOAD} \leq 0.5A$	1.193 1.180	1.230	1.267 1.280	V V
Efficiency	$I_{LOAD} = 0.5A$, $V_{OUT} = 5V$		77		%
Feedback Bias Current			50	100 500	nA nA
MIC4574-3.3					
Output Voltage		3.234	3.3	3.366	V
Output Voltage	$6V \leq V_{IN} \leq 24V$, $0.1A \leq I_{LOAD} \leq 0.5A$	3.168 3.135	3.3	3.432 3.465	V V
Efficiency			72		%
MIC4574-5.0					
Output Voltage		4.900	5.0	5.100	V
Output Voltage	$8V \leq V_{IN} \leq 24V$, $0.1A \leq I_{LOAD} \leq 0.5A$	4.800 4.750	5.0	5.200 5.250	V V
Efficiency			77		%
MIC4574 / -3.3 / -5.0					
Oscillator Frequency		180	200	220	kHz
Saturation Voltage	$I_{OUT} = 0.5A$		1	1.3 1.5	V V
Maximum Duty Cycle (On)	FB connected to 0V	90	95		%
Current Limit	Peak Current, $t_{ON} \leq 3\mu s$	0.7 0.65	1.0	1.6 1.8	A A
Output Leakage Current	$V_{IN} = 24V$, FB connected to 6V Output = 0V Output = -1V		0 7.5	2 30	mA mA
Quiescent Current			5	10	mA
Standby Quiescent Current	SHDN = 5V (regulator off)		50	200	μA
SHDN Input Logic Level	$V_{OUT} = 0V$ (regulator off)	2.2 2.4	1.4		V V
	$V_{OUT} = 3.3V$ or $5V$ (regulator on)		1.2	1.0 0.8	V V
SHDN Input Current	SHDN = 5V (regulator off) SHDN = 0V (regulator on)	-10	4 0.01	30 10	μA μA

General Note: Devices are ESD protected, however, handling precautions are recommended.

Note 1: The MIC4574 is not guaranteed to survive a short circuit to ground for input voltage above 24V.

Block Diagrams

[查询"MIC4574"供应商](#)

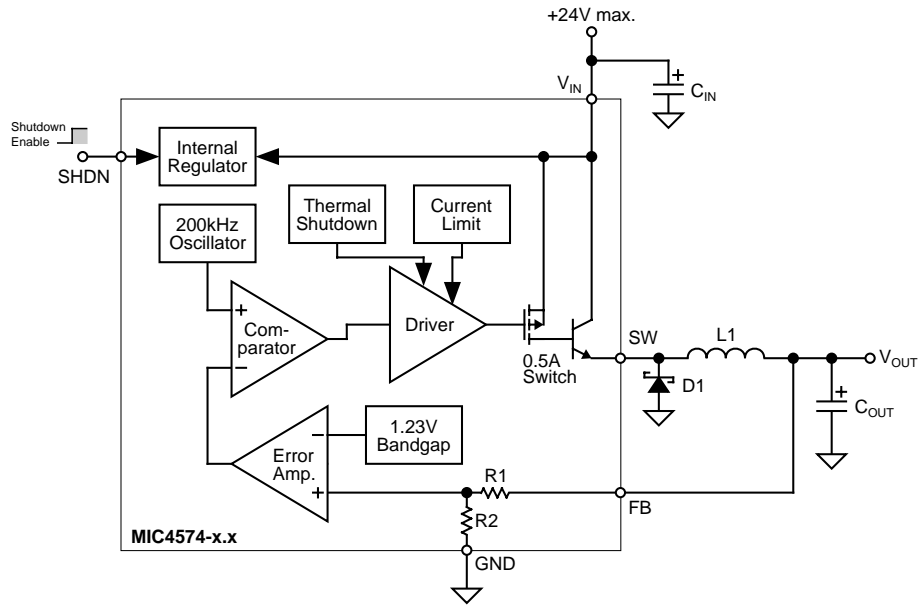

**Block Diagram with External Components
Fixed Step-Down Regulator**

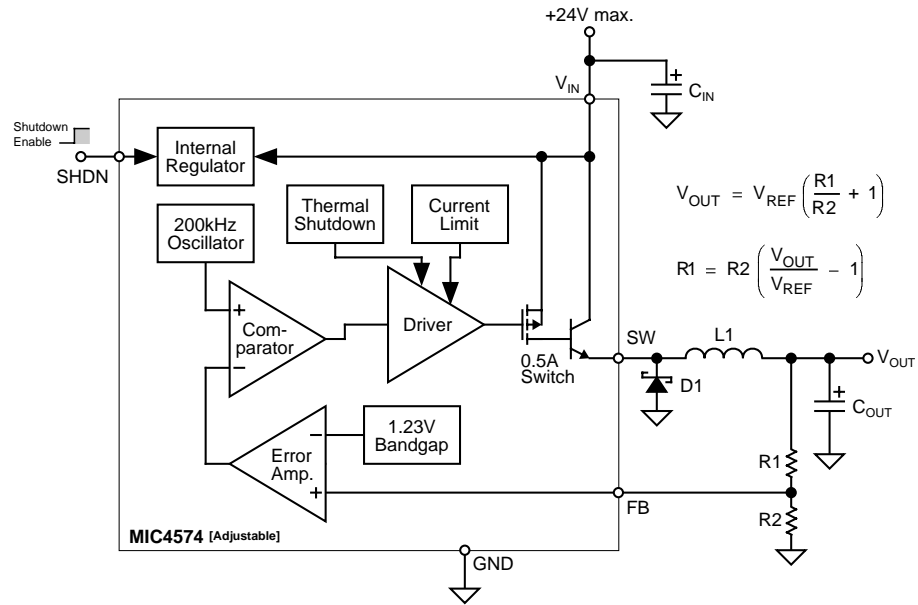

$$V_{OUT} = V_{REF} \left(\frac{R1}{R2} + 1 \right)$$

$$R1 = R2 \left(\frac{V_{OUT}}{V_{REF}} - 1 \right)$$

**Block Diagram with External Components
Adjustable Step-Down Regulator**

Functional Description

The MIC4574 is a variable duty cycle switch-mode regulator with an internal power switch. Refer to the block diagrams.

Supply Voltage

The MIC4574 operates from a +4V to +24V unregulated input. Highest efficiency operation is from a supply voltage below +15V.

Enable/Shutdown

The shutdown (SHDN) input is TTL compatible. Ground the input if unused. A logic-low enables the regulator. A logic-high shuts down the internal regulator which reduces the current to typically 50 μ A.

Feedback

Fixed versions of the regulator have an internal resistive divider from the feedback (FB) pin. Connect FB directly to the output line.

Adjustable versions require an external resistive voltage divider from the output voltage to ground, connected from the 1.23V tap to FB.

Duty Cycle Control

A fixed-gain error amplifier compares the feedback signal with a 1.23V bandgap voltage reference. The resulting error amplifier output voltage is compared to a 200kHz sawtooth waveform to produce a voltage controlled variable duty cycle output.

A higher feedback voltage increases the error amplifier output voltage. A higher error amplifier voltage (comparator inverting input) causes the comparator to detect only the peaks of the sawtooth, reducing the duty cycle of the comparator output. A lower feedback voltage increases the duty cycle.

Output Switching

When the internal switch is on, an increasing current flows from the supply V_{IN} , through external storage inductor L1, to output capacitor C_{OUT} and the load. Energy is stored in the inductor as the current increases with time.

When the internal switch is turned off, the collapse of the magnetic field in L1 forces current to flow through fast recovery diode D1, charging C_{OUT} .

Output Capacitor

External output capacitor C_{OUT} provides stabilization and reduces ripple.

Return Paths

During the on portion of the cycle, the output capacitor and load currents return to the supply ground. During the off portion of the cycle, current is being supplied to the output capacitor and load by storage inductor L1, which means that D1 is part of the high-current return path.

Applications Information

The applications circuits that follow have been constructed and tested. Refer to Application Note 15 for additional information, including efficiency graphs and manufacturer's addresses and telephone numbers for most circuits.

For a mathematical approach to component selection and circuit design, refer to Application Note 14.

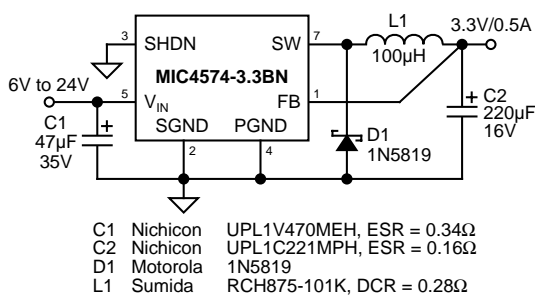

Figure 1. 6V–24V to 3.3V/0.5A Buck Converter Through Hole

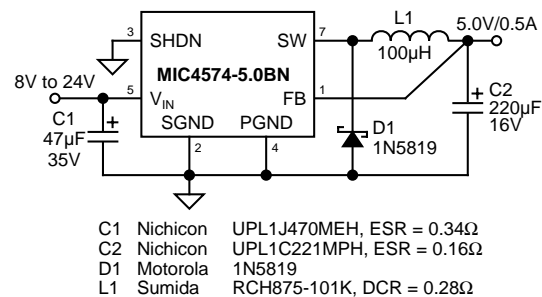

Figure 2. 8V–24V to 5V/0.5A Buck Converter Through Hole

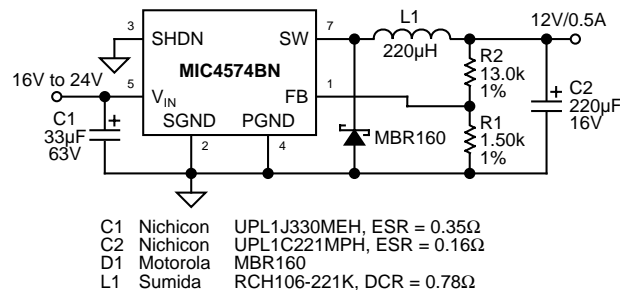

Figure 3. 16V–24V to 12V/0.5A Buck Converter Through Hole

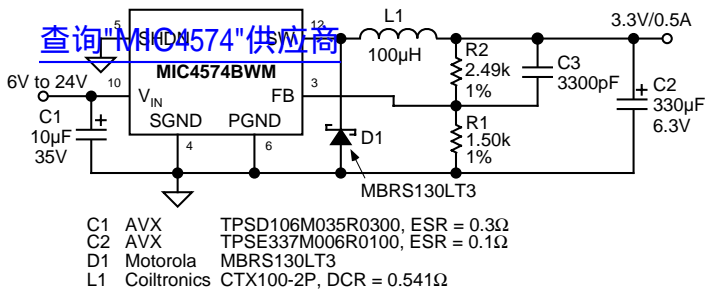

Figure 4. 6V–24V to 3.3V/0.5A Buck Converter Low-Profile Surface Mount

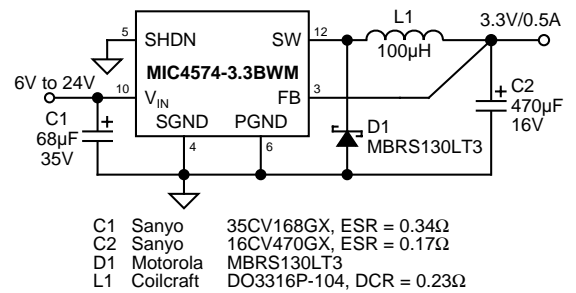

Figure 7. 6V–24V to 3.3V/0.5A Buck Converter Low-Cost Surface Mount

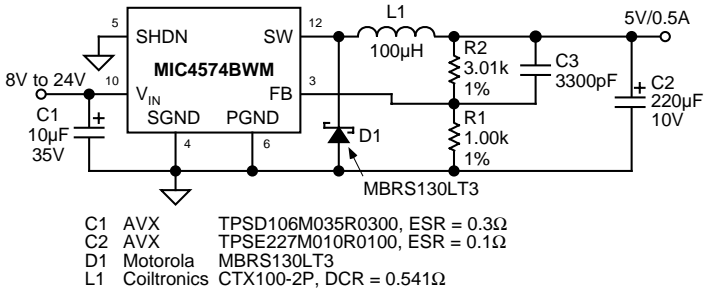

Figure 5. 8V–24V to 5V/0.5A Buck Converter Low-Profile Surface Mount

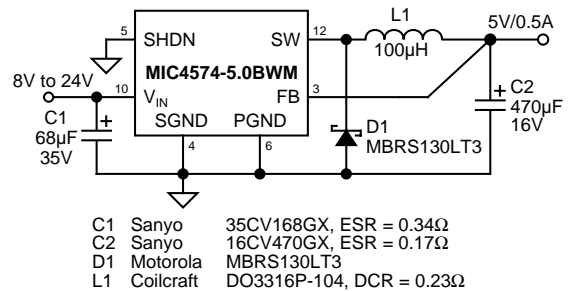

Figure 8. 8V–24V to 5V/0.5A Buck Converter Low-Cost Surface Mount

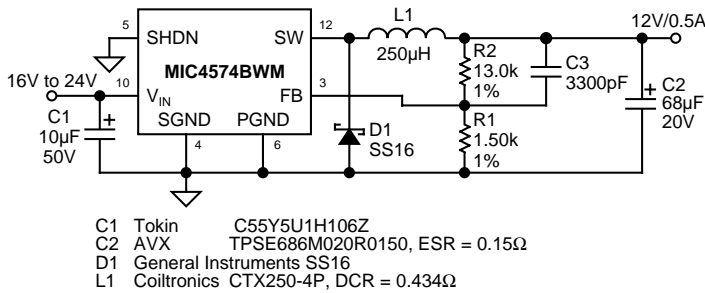

Figure 6. 16V–24V to 12V/0.5A Buck Converter Low-Profile Surface Mount

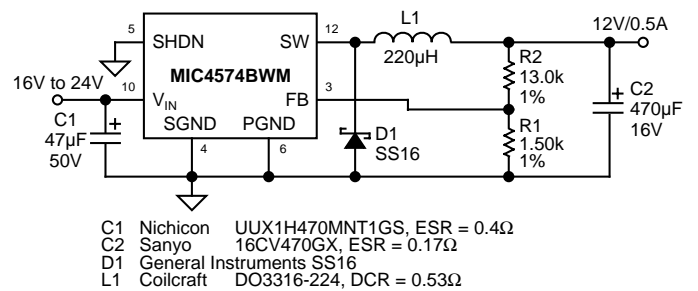

Figure 9. 16V–24V to 12V/0.5A Buck Converter Low-Cost Surface Mount