

## AD8565/AD8566/AD8567

### FEATURES

- Single-supply operation: 4.5 V to 16 V
- Input capability beyond the rails
- Rail-to-rail output swing
- Continuous output current: 35 mA
- Peak output current: 250 mA
- Offset voltage: 10 mV
- Slew rate: 6 V/ $\mu$ s
- Unity gain stable with large capacitive loads
- Supply current: 700  $\mu$ A per amplifier

### APPLICATIONS

- LCD reference drivers
- Portable electronics
- Communications equipment

### GENERAL DESCRIPTION

The AD8565, AD8566, and AD8567 are low cost, single-supply, rail-to-rail input and output operational amplifiers optimized for LCD monitor applications. They are built on an advanced high voltage CBCMOS process. The AD8565 contains a single amplifier, the AD8566 has two amplifiers, and the AD8567 has four amplifiers.

These LCD op amps have high slew rates, 35 mA continuous output drive, 250 mA peak output drive, and a high capacitive load drive capability. They have a wide supply range and offset voltages below 10 mV. The AD8565, AD8566, and AD8567 are ideal for LCD grayscale reference buffer and  $V_{COM}$  applications.

The AD8565, AD8566, and AD8567 are specified over the  $-40^{\circ}\text{C}$  to  $+85^{\circ}\text{C}$  temperature range. The AD8565 single is available in a 5-lead SC70 package. The AD8566 dual is available in an 8-lead MSOP package. The AD8567 quad is available in a 14-lead TSSOP package and a 16-lead LFCSP package.

### PIN CONFIGURATIONS

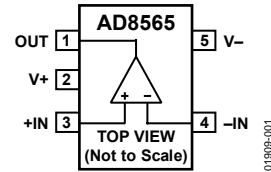

Figure 1. 5-Lead SC70 Pin Configuration

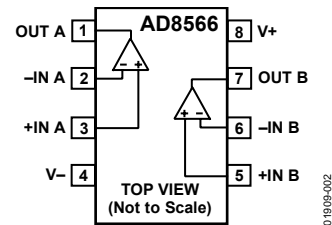

Figure 2. 8-Lead MSOP Pin Configuration

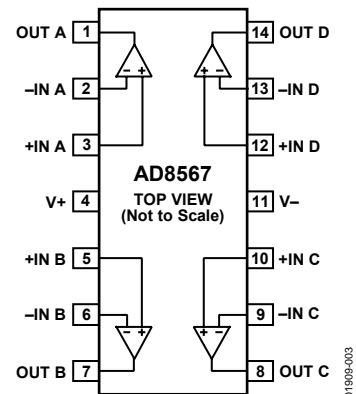

Figure 3. 14-Lead TSSOP Pin Configuration

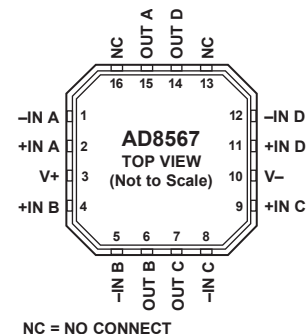

Figure 4. 16-Lead LFCSP Pin Configuration

### Rev. D

Information furnished by Analog Devices is believed to be accurate and reliable. However, no responsibility is assumed by Analog Devices for its use, nor for any infringements of patents or other rights of third parties that may result from its use. Specifications subject to change without notice. No license is granted by implication or otherwise under any patent or patent rights of Analog Devices. Trademarks and registered trademarks are the property of their respective owners.

## TABLE OF CONTENTS

Features .....	1	Input Overvoltage Protection .....	9
Applications.....	1	Output Phase Reversal.....	10
General Description.....	1	Power Dissipation.....	10
Pin Configurations .....	1	Thermal Pad—AD8567 .....	10
Revision History .....	2	Total Harmonic Distortion + Noise (THD+N).....	11
Specifications.....	3	Short-Circuit Output Conditions.....	11
Electrical Characteristics .....	3	LCD Panel Applications .....	11
Absolute Maximum Ratings.....	4	Outline Dimensions .....	12
ESD Caution.....	4	Ordering Guide .....	13
Typical Performance Characteristics .....	5		
Theory of Operation .....	9		

## REVISION HISTORY

### 2/06—Rev C to Rev. D

Updated Format.....	Universal
Changes to Figure 6 and Figure 8.....	5
Added the Thermal Pad—AD8567 Section.....	10
Changes to Ordering Guide .....	13

### 3/04—Rev B to Rev. C

Changes to Specifications .....	2
Changes to TPC 4.....	4
Changes to TPC 10.....	5
Changes to TPC 14.....	6
Changes to TPC 20.....	7

### 12/03—Rev. A to Rev. B

Updated Ordering Guide.....	3
Updated Outline Dimensions .....	11

### 10/01—Rev. 0 to Rev. A

Edit to 16-Lead CSP and 5-Lead SC70 Pin Configuration .....	1
Edit to Ordering Guide.....	3

### 7/01—Revision 0: Initial Version

# SPECIFICATIONS

## ELECTRICAL CHARACTERISTICS

4.5 V ≤ V<sub>S</sub> ≤ 16 V, V<sub>CM</sub> = V<sub>S</sub>/2, T<sub>A</sub> = 25°C, unless otherwise noted.

Table 1.

Parameter	Symbol	Conditions	Min	Typ	Max	Unit
<b>INPUT CHARACTERISTICS</b>						
Offset Voltage	V <sub>OS</sub>			2	10	mV
Offset Voltage Drift	ΔV <sub>OS</sub> /ΔT	-40°C ≤ T <sub>A</sub> ≤ +85°C		5		μV/°C
Input Bias Current	I <sub>B</sub>	-40°C ≤ T <sub>A</sub> ≤ +85°C		80	600	nA
Input Offset Current	I <sub>OS</sub>	-40°C ≤ T <sub>A</sub> ≤ +85°C		1	80	nA
Input Voltage Range		Common-mode input	-0.5		V <sub>S</sub> + 0.5	V
Common-Mode Rejection Ratio	CMRR	V <sub>CM</sub> = 0 to V <sub>S</sub> , -40°C ≤ T <sub>A</sub> ≤ +85°C	54	95		dB
Large Signal Voltage Gain	AVO	R <sub>L</sub> = 10 kΩ, V <sub>O</sub> = 0.5 V to (V <sub>S</sub> - 0.5 V)	3	10		V/mV
Input Impedance	Z <sub>IN</sub>			400		kΩ
Input Capacitance	C <sub>IN</sub>			1		pF
<b>OUTPUT CHARACTERISTICS</b>						
Output Voltage High	V <sub>OH</sub>	I <sub>L</sub> = 100 μA V <sub>S</sub> = 16 V, I <sub>L</sub> = 5 mA -40°C ≤ T <sub>A</sub> ≤ +85°C	15.85	V <sub>S</sub> - 0.005 15.95		V
		V <sub>S</sub> = 4.5 V, I <sub>L</sub> = 5 mA -40°C ≤ T <sub>A</sub> ≤ +85°C	15.75			V
			4.2	4.38		V
			4.1			V
Output Voltage Low	V <sub>OL</sub>	I <sub>L</sub> = 100 μA V <sub>S</sub> = 16 V, I <sub>L</sub> = 5 mA -40°C ≤ T <sub>A</sub> ≤ +85°C		5		mV
		V <sub>S</sub> = 4.5 V, I <sub>L</sub> = 5 mA -40°C ≤ T <sub>A</sub> ≤ +85°C		42	150	mV
					250	mV
				95	300	mV
					400	mV
Continuous Output Current	I <sub>OUT</sub>			35		mA
Peak Output Current	I <sub>PK</sub>	V <sub>S</sub> = 16 V		250		mA
<b>POWER SUPPLY</b>						
Supply Voltage	V <sub>S</sub>		4.5		16	V
Power Supply Rejection Ratio	PSRR	V <sub>S</sub> = 4 V to 17 V, -40°C ≤ T <sub>A</sub> ≤ +85°C	70	90		dB
Supply Current/Amplifier	I <sub>SY</sub>	V <sub>O</sub> = V <sub>S</sub> /2, no load -40°C ≤ T <sub>A</sub> ≤ +85°C		700	850	μA
					1	mA
<b>DYNAMIC PERFORMANCE</b>						
Slew Rate	SR	R <sub>L</sub> = 10 kΩ, C <sub>L</sub> = 200 pF	4	6		V/μs
Gain Bandwidth Product	GBP	R <sub>L</sub> = 10 kΩ, C <sub>L</sub> = 10 pF		5		MHz
Phase Margin	∅ <sub>O</sub>	R <sub>L</sub> = 10 kΩ, C <sub>L</sub> = 10 pF		65		Degrees
Channel Separation				75		dB
<b>NOISE PERFORMANCE</b>						
Voltage Noise Density	e <sub>n</sub>	f = 1 kHz		26		nV/√Hz
	e <sub>n</sub>	f = 10 kHz		25		nV/√Hz
Current Noise Density	i <sub>n</sub>	f = 10 kHz		0.8		pA/√Hz

## ABSOLUTE MAXIMUM RATINGS

Table 2.

Parameter	Ratings
Supply Voltage ( $V_S$ )	18 V
Input Voltage	-0.5 V to $V_S + 0.5$ V
Differential Input Voltage	$V_S$
Storage Temperature Range	-65°C to +150°C
Operating Temperature Range	-40°C to +85°C
Junction Temperature Range	-65°C to +150°C
Lead Temperature (Soldering, 60 sec)	300°C

Stresses above those listed under Absolute Maximum Ratings may cause permanent damage to the device. This is a stress rating only; functional operation of the device at these or any other conditions above those listed in the operational sections of this specification is not implied. Exposure to absolute maximum rating conditions for extended periods may affect device reliability.

### ESD CAUTION

ESD (electrostatic discharge) sensitive device. Electrostatic charges as high as 4000 V readily accumulate on the human body and test equipment and can discharge without detection. Although this product features proprietary ESD protection circuitry, permanent damage may occur on devices subjected to high energy electrostatic discharges. Therefore, proper ESD precautions are recommended to avoid performance degradation or loss of functionality.



Table 3.

Package Type	$\theta_{JA}$ <sup>1</sup>	$\theta_{JC}$	Unit
5-Lead SC70 (KS-5)	376	126	°C/W
8-Lead MSOP (RM-8)	210	45	°C/W
14-Lead TSSOP (RU-14)	180	35	°C/W
16-Lead LFCSP (CP-16-4)	38 <sup>2</sup>	30 <sup>2</sup>	°C/W

<sup>1</sup>  $\theta_{JA}$  is specified for worst-case conditions, that is,  $\theta_{JA}$  is specified for a device soldered onto a circuit board for surface-mount packages.

<sup>2</sup> DAP is soldered down to PCB.

# TYPICAL PERFORMANCE CHARACTERISTICS

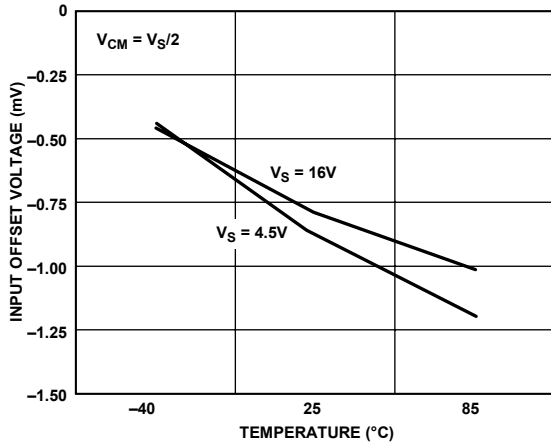

Figure 5. Input Offset Voltage vs. Temperature

01909-005

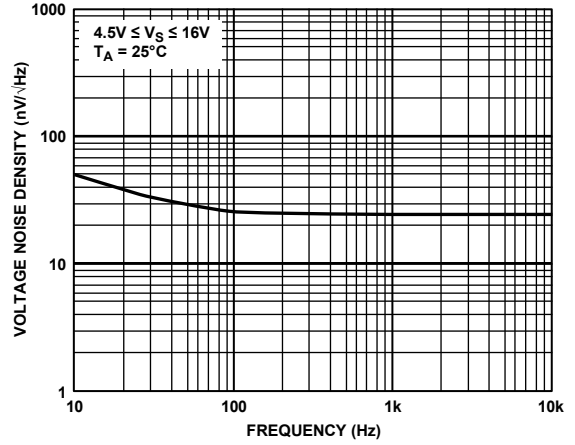

Figure 8. Voltage Noise Density vs. Frequency

01909-008

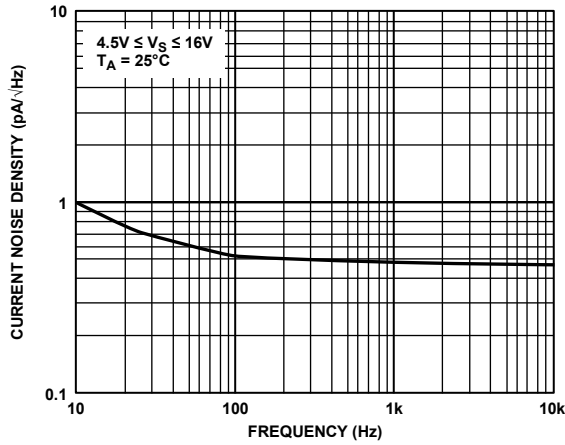

Figure 6. Current Noise Density vs. Frequency

01909-006

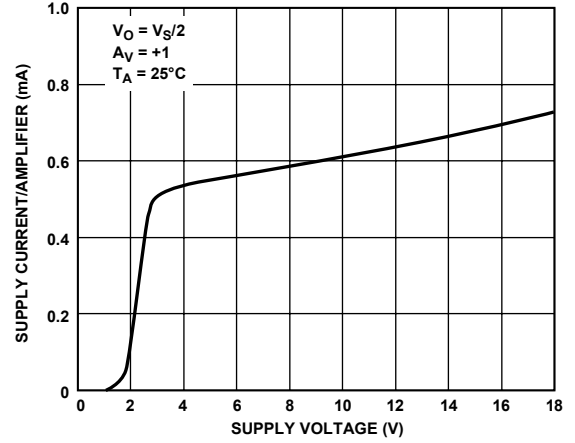

Figure 9. Supply Current/Amplifier vs. Supply Voltage

01909-009

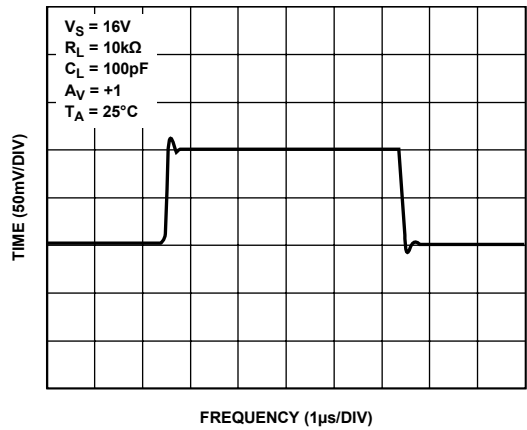

Figure 7. Small Signal Transient Response

01909-007

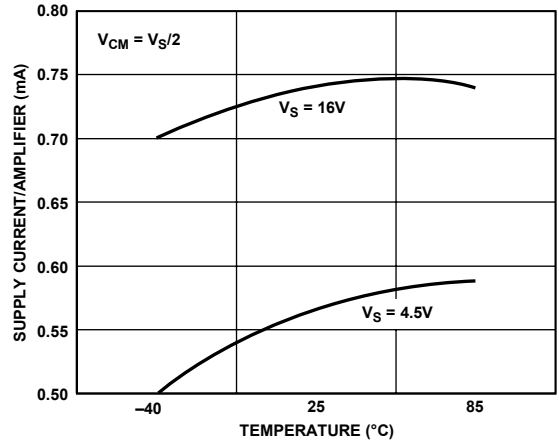

Figure 10. Supply Current/Amplifier vs. Temperature

01909-010

# AD8565/AD8566/AD8567

查询"AD8567ACP-REEL7"供应商

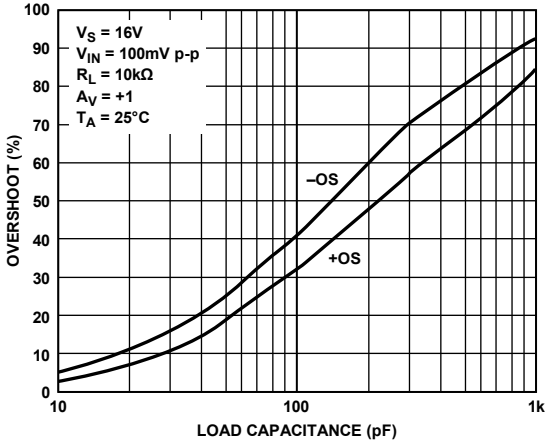

Figure 11. Small Signal Overshoot vs. Load Capacitance

01909-011

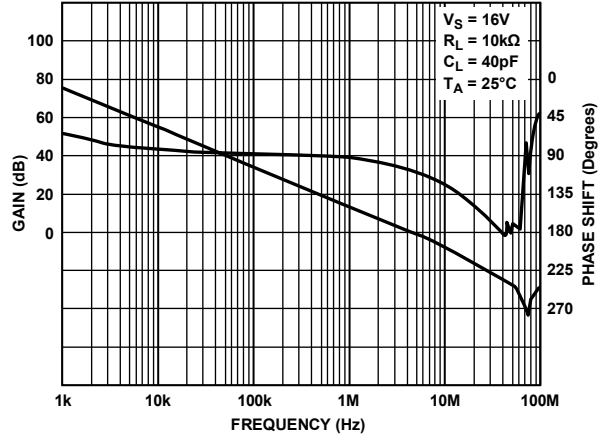

Figure 14. Open-Loop Gain and Phase Shift vs. Frequency

01909-014

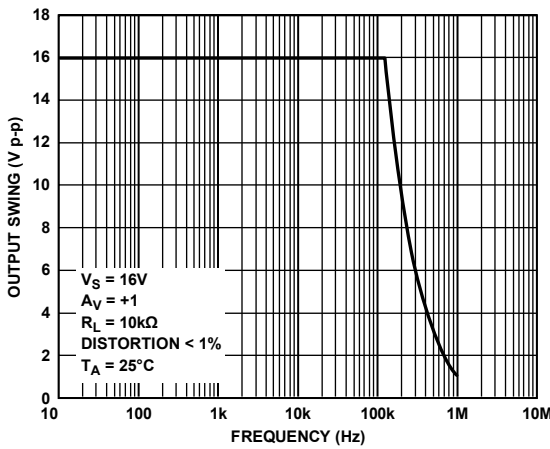

Figure 12. Closed-Loop Output Swing vs. Frequency

01909-012

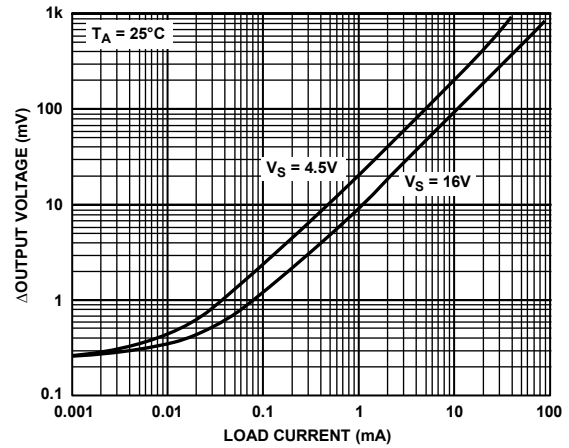

Figure 15. Output Voltage to Supply Rail vs. Load Current

01909-015

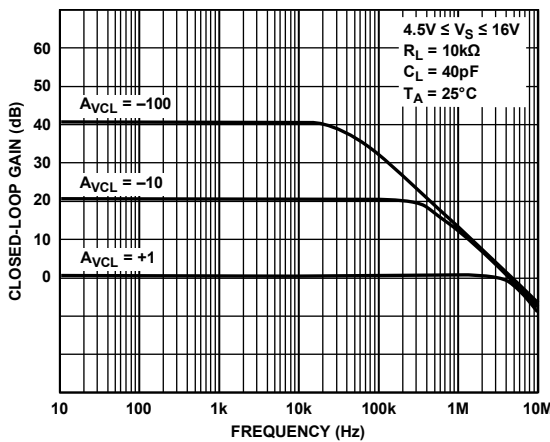

Figure 13. Closed-Loop Gain vs. Frequency

01909-013

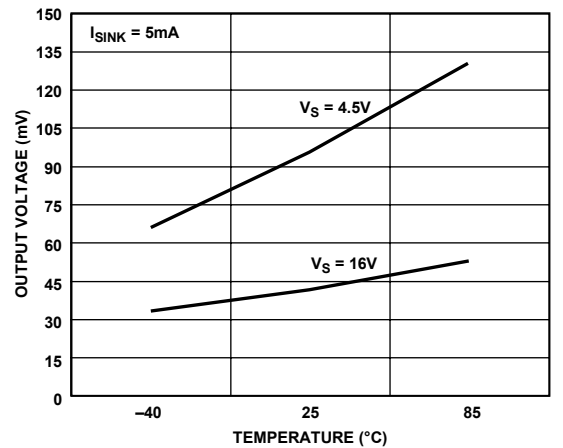

Figure 16. Output Voltage Swing to Rail vs. Temperature

01909-016

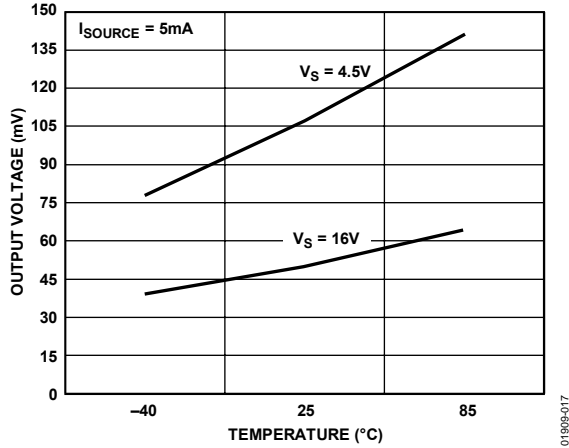

Figure 17. Output Voltage Swing to Rail vs. Temperature

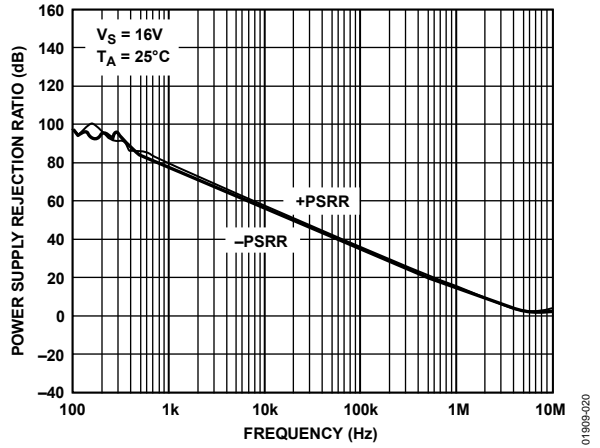

Figure 20. Power Supply Rejection Ratio vs. Frequency

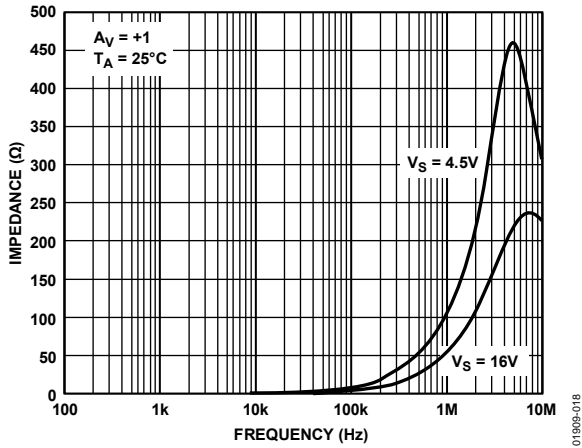

Figure 18. Closed-Loop Output Impedance vs. Frequency

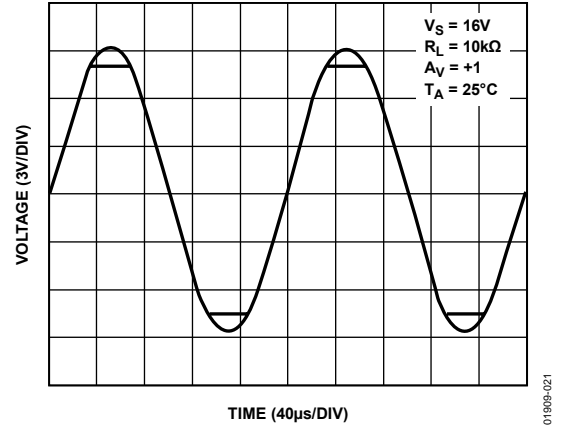

Figure 21. No Phase Reversal

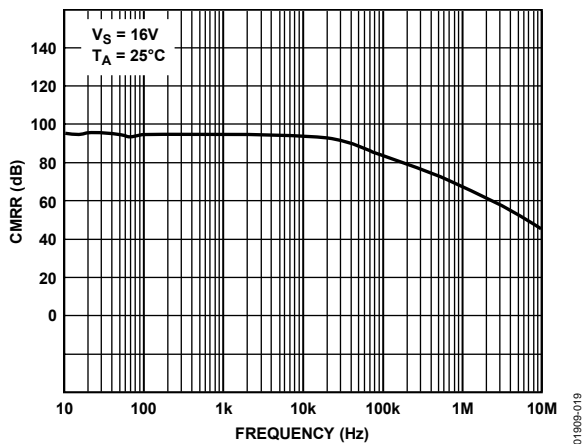

Figure 19. Common-Mode Rejection Ratio (CMRR) vs. Frequency

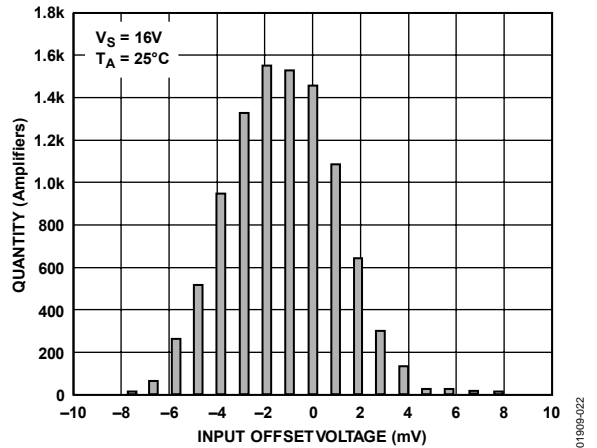

Figure 22. Input Offset Voltage Distribution

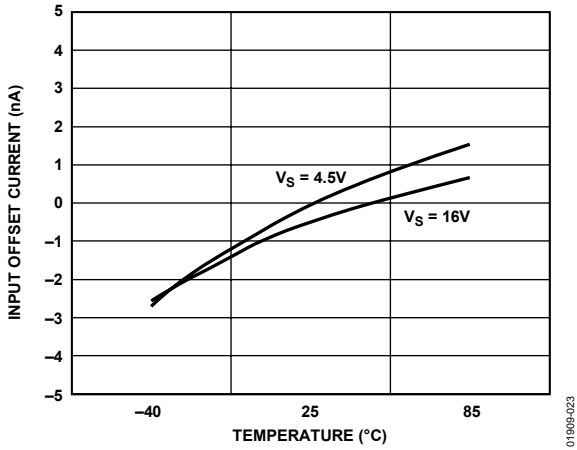

Figure 23. Input Offset Current vs. Temperature

01909-023

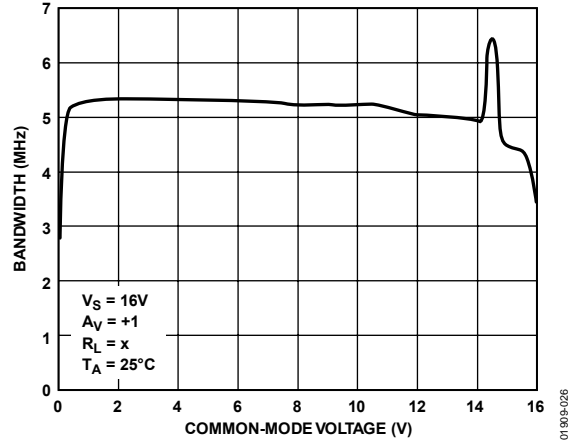

Figure 26. Frequency vs. Common-Mode Voltage ( $V_S = 16V$ )

01909-026

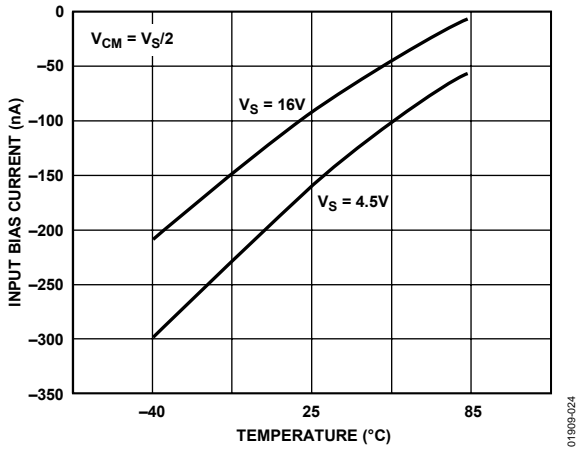

Figure 24. Input Bias Current vs. Temperature

01909-024

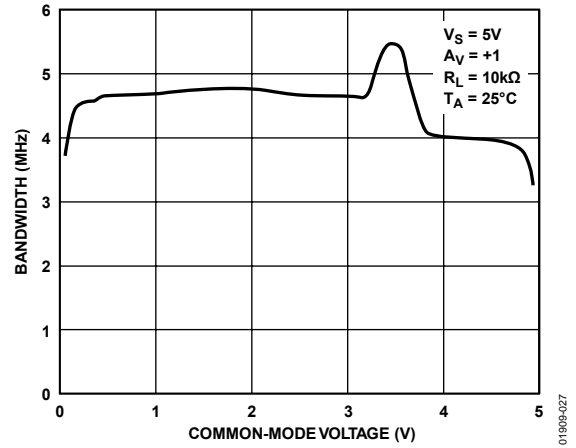

Figure 27. Frequency vs. Common-Mode Voltage ( $V_S = 5V$ )

01909-027

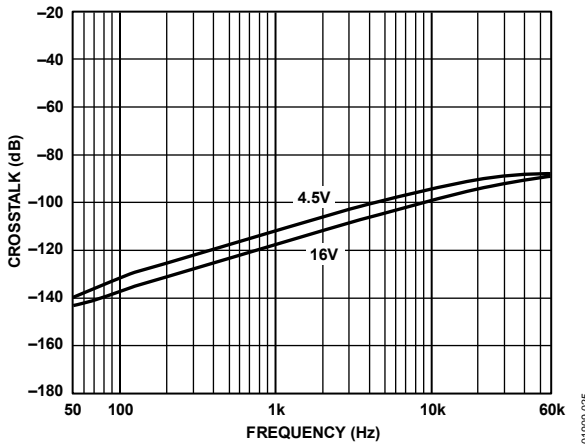

Figure 25. Channel A vs. Channel B Crosstalk

01909-025



## THEORY OF OPERATION

The AD856x family is designed to drive large capacitive loads in LCD applications. It has high output current drive, rail-to-rail input/output operation, and is powered from a single 16 V supply. It is also intended for other applications where low distortion and high output current drive are needed.

Figure 28 illustrates a simplified equivalent circuit for the AD856x. The rail-to-rail bipolar input stage is composed of two PNP differential pairs, Q4 to Q5 and Q10 to Q11, operating in series with diode protection networks, D1 to D2. Diode network D1 to D2 serves as protection against large transients for Q4 to Q5 to accommodate rail-to-rail input swing. D5 to D6 protect Q10 to Q11 against Zenering. In normal operation, Q10 to Q11 are off and their input stage is buffered from the operational amplifier inputs by Q6 to D3 and Q8 to D4. Operation of the input stage is best understood as a function of applied common-mode voltage: when the inputs of the AD856x are biased midway between the supplies, the differential signal path gain is controlled by resistive loads (via R9, R10) Q4 to Q5. As the input common-mode level is reduced toward the negative supply ( $V_{NEG}$  or GND), the input transistor current sources, I1 and I2, are forced into saturation, thereby forcing the Q6 to D3 and Q8 to D4 networks into cutoff. However, Q4 to Q5 remain active, providing input stage gain. Inversely, when common-mode input voltage is increased toward the positive supply, Q4 to Q5 are driven into cutoff, Q3 is driven into saturation, and Q4 becomes active, providing bias to the Q10 to Q11 differential pair. The point at which Q10 to Q11 differential pair becomes active is approximately equal to  $(V_{POS} - 1 V)$ .

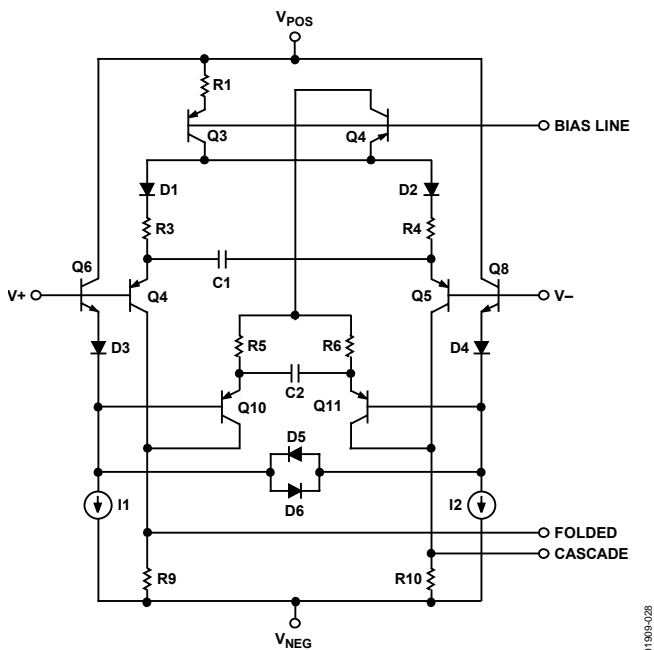

Figure 28. AD856x Equivalent Input Circuit

The benefit of this type of input stage is low bias current. The input bias current is the sum of base currents of Q4 to Q5 and Q6 to Q8 over the range from  $(V_{NEG} + 1 V)$  to  $(V_{POS} - 1 V)$ . Outside of this range, input bias current is dominated by the sum of base currents of Q10 to Q11 for input signals close to  $V_{NEG}$  and of Q6 to Q8 (Q10 to Q11) for signals close to  $V_{POS}$ . From this type of design, the input bias current of AD856x not only exhibits different amplitude but also exhibits different polarities. Figure 29 provides the characteristics of the input bias current vs. the common-mode voltage. It is important to keep in mind that the source impedances driving the AD856x inputs are balanced for optimum dc and ac performance.

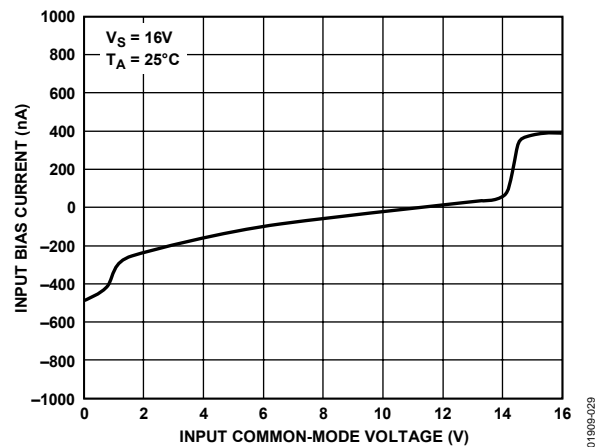

Figure 29. AD856x Input Bias Current vs. Common-Mode Voltage

To achieve rail-to-rail output performance, the AD856x design uses a complementary common-source (or gmRL) output. This configuration allows output voltages to approach the power supply rails, particularly if the output transistors are allowed to enter the triode region on extremes of signal swing, which are limited by  $V_{GS}$ , the transistor sizes, and output load current. In addition, this type of output stage exhibits voltage gain in an open-loop gain configuration. The amount of gain depends on the total load resistance at the output of the AD856x.

## INPUT OVERVOLTAGE PROTECTION

As with any semiconductor device, whenever the input exceeds either supply voltages, attention needs to be paid to the input overvoltage characteristics. As an overvoltage occurs, the amplifier could be damaged, depending on the voltage level and the magnitude of the fault current. When the input voltage exceeds either supply by more than 0.6 V, internal pn junctions allow current to flow from the input to the supplies.

This input current is not inherently damaging to the device as long as it is limited to 5 mA or less. If a condition exists using the AD856x where the input exceeds the supply more than 0.6 V, an external series resistor should be added. The size of the resistor can be calculated by using the maximum overvoltage divided by 5 mA. This resistance should be placed in series with either input exposed to an overvoltage.

**OUTPUT PHASE REVERSAL**

The AD856x family is immune to phase reversal. Although the device’s output does not change phase, large currents due to input overvoltage could damage the device. In applications where the possibility of an input voltage exceeding the supply voltage exists, overvoltage protection should be used as described in the Input Overvoltage Protection section.

**POWER DISSIPATION**

The maximum allowable internal junction temperature of 150°C limits the AD856x family’s maximum power dissipation of AD856x devices. As the ambient temperature increases, the maximum power dissipated by AD856x devices must decrease linearly to maintain the maximum junction temperature. If this maximum junction temperature is exceeded momentarily, the device still operates properly once the junction temperature is reduced below 150°C. If the maximum junction temperature is exceeded for an extended period, overheating could lead to permanent damage of the device.

The maximum safe junction temperature,  $T_{JMAX}$ , is 150°C. Using the following formula, the maximum power that an AD856x device can safely dissipate as a function of temperature can be obtained:

$$P_{DISS} = T_{JMAX} - T_A / \theta_{JA}$$

where:

$P_{DISS}$  is the AD856x power dissipation.

$T_{JMAX}$  is the AD856x maximum allowable junction temperature (150°C).

$T_A$  is the ambient temperature of the circuit.

$\theta_{JA}$  is the AD856x package thermal resistance, junction-to-ambient.

The power dissipated by the device can be calculated as

$$P_{DISS} = (V_S - V_{OUT}) \times I_{LOAD}$$

where:

$V_S$  is the supply voltage.

$V_{OUT}$  is the output voltage.

$I_{LOAD}$  is the output load current.

Figure 30 shows the maximum power dissipation vs. temperature. To achieve proper operation, use the previous equation to calculate  $P_{DISS}$  for a specific package at any given temperature or use Figure 30.

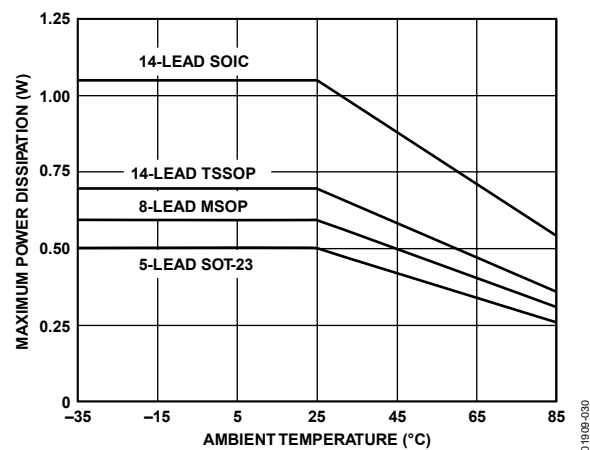

Figure 30. Maximum Power Dissipation vs. Temperature for 5-Lead SC70, 8-Lead MSOP, and 14-Lead TSSOP/SOIC Packages

**THERMAL PAD—AD8567**

The AD8567 LFCSP comes with a thermal pad that is attached to the substrate. This substrate is connected to  $V_{DD}$ . To be electrically safe, the thermal pad should be soldered to an area on the board that is electrically isolated or connected to  $V_{DD}$ . Attaching the thermal pad to ground adversely affects the performance of the part.

Soldering down this thermal pad dramatically improves the heat dissipation of the package. It is necessary to attach vias that connect the soldered thermal pad to another layer on the board. This provides an avenue to dissipate the heat away from the part. Without vias, the heat is isolated directly under the part.

**TOTAL HARMONIC DISTORTION + NOISE (THD+N)**

The AD856x family features low total harmonic distortion. Figure 31 shows THD+N vs. frequency. The THD+N for the AD856x over the entire supply range is below 0.008%. When the device is powered from a 16 V supply, the THD+N stays below 0.003%. Figure 31 shows the AD8566 in a unity noninverting configuration.

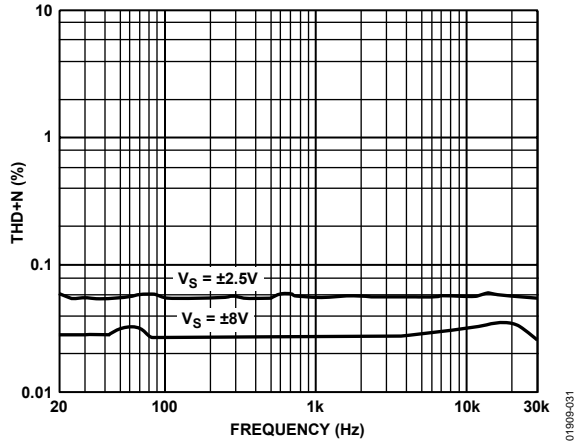

Figure 31. THD+N vs. Frequency

**SHORT-CIRCUIT OUTPUT CONDITIONS**

The AD856x family does not have internal short-circuit protection circuitry. As a precautionary measure, it is recommended not to short the output directly to the positive power supply or to ground.

It is not recommended to operate the AD856x with more than 35 mA of continuous output current. The output current can be limited by placing a series resistor at the output of the amplifier whose value can be derived using

$$R_x \geq \frac{V_s}{35 \text{ mA}}$$

For a 5 V single-supply operation,  $R_x$  should have a minimum value of 143  $\Omega$ .

**LCD PANEL APPLICATIONS**

The AD856x amplifier is designed for LCD panel applications or applications where large capacitive load drive is required. It can instantaneously source/sink greater than 250 mA of current. At unity gain, it can drive 1  $\mu\text{F}$  without compensation. This makes the AD856x ideal for LCD  $V_{\text{COM}}$  driver applications.

To evaluate the performance of the AD856x family, a test circuit was developed to simulate the  $V_{\text{COM}}$  driver application for an LCD panel.

Figure 32 shows the test circuit. Series capacitors and resistors connected to the output of the op amp represent the load of the LCD panel. The 300  $\Omega$  and 3 k $\Omega$  feedback resistors are used to improve settling time. This test circuit simulates the worst-case scenario for a  $V_{\text{COM}}$ . It drives a represented load that is connected to a signal switched symmetrically around  $V_{\text{COM}}$ . Figure 33 shows a scope photo of the instantaneous output peak current capability of the AD856x family.

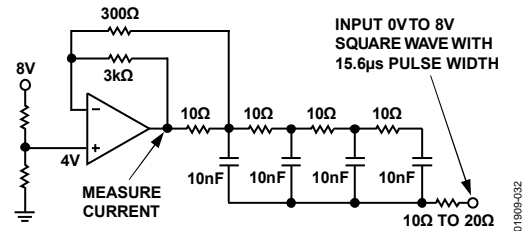

Figure 32.  $V_{\text{COM}}$  Test Circuit with Supply Voltage at 16 V

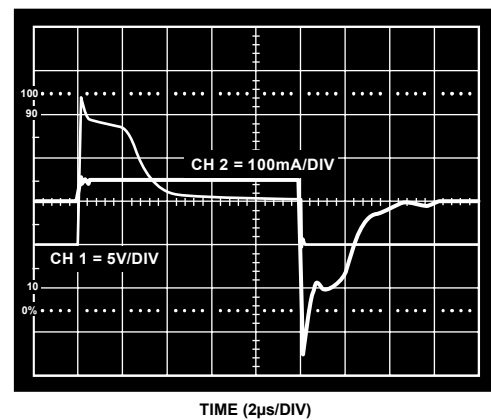
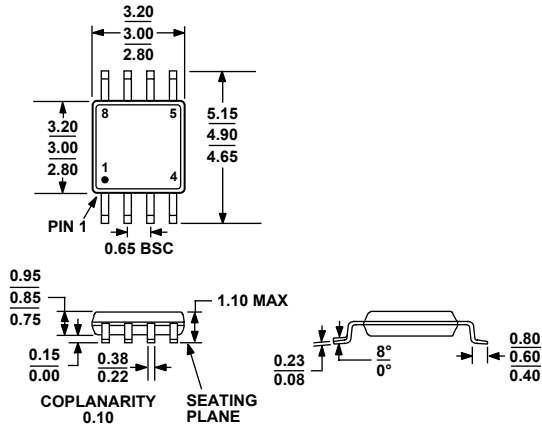

Figure 33. Scope Photo of the  $V_{\text{COM}}$  Instantaneous Peak Current

# OUTLINE DIMENSIONS



COMPLIANT TO JEDEC STANDARDS MO-187-AA

Figure 34. 8-Lead Micro Small Outline Package [MSOP] (RM-8)  
Dimensions shown in millimeters

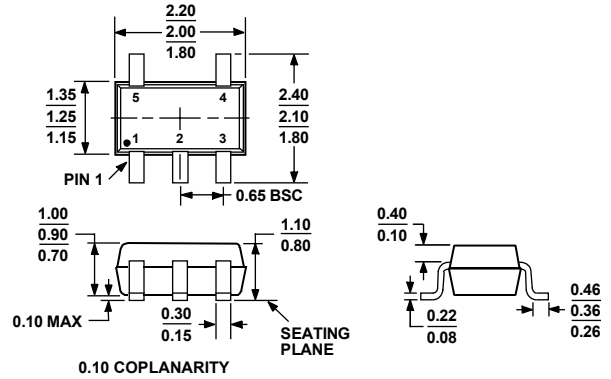

COMPLIANT TO JEDEC STANDARDS MO-203-AA

Figure 35. 5-Lead Thin Shrink Small Outline Transistor Package [SC70] (KS-5)  
Dimensions shown in millimeters

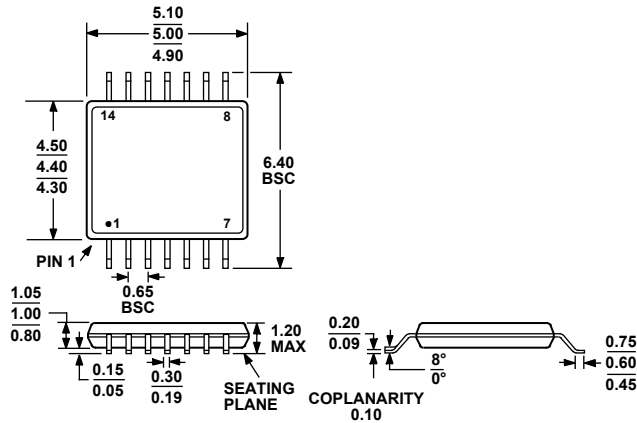

COMPLIANT TO JEDEC STANDARDS MO-153-AB-1

Figure 36. 14-Lead Thin Shrink Small Outline Package [TSSOP] (RU-14)  
Dimensions shown in millimeters

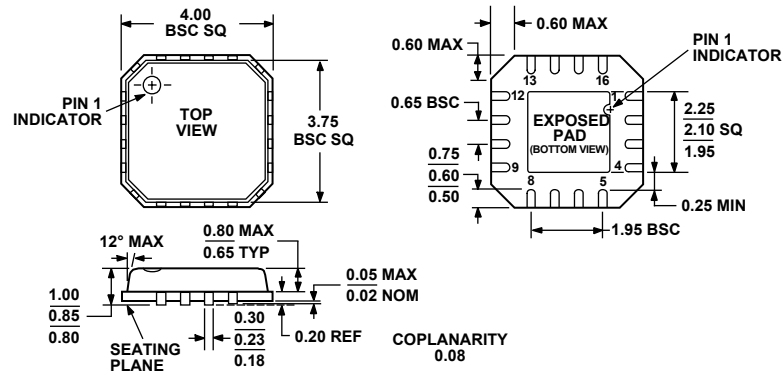

COMPLIANT TO JEDEC STANDARDS MO-220-VGGC

Figure 37. 16-Lead Lead Frame Chip Scale Package [LFCSF\_VQ]  
4 mm × 4 mm Body, Very Thin Quad  
(CP-16-4)  
Dimensions shown in millimeters

## ORDERING GUIDE

Model	Temperature Range	Package Description	Package Option	Branding
AD8565AKS-R2	-40°C to +85°C	5-Lead Thin Shrink Small Outline Transistor Package (SC70)	KS-5	ASA
AD8565AKS-REEL7	-40°C to +85°C	5-Lead Thin Shrink Small Outline Transistor Package (SC70)	KS-5	ASA
AD8565AKSZ-REEL7 <sup>1</sup>	-40°C to +85°C	5-Lead Thin Shrink Small Outline Transistor Package (SC70)	KS-5	A0N
AD8566ARM-R2	-40°C to +85°C	8-Lead Micro Small Outline Package (MSOP)	RM-8	ATA
AD8566ARM-REEL	-40°C to +85°C	8-Lead Micro Small Outline Package (MSOP)	RM-8	ATA
AD8566ARMZ-R2 <sup>1</sup>	-40°C to +85°C	8-Lead Micro Small Outline Package (MSOP)	RM-8	ATA#
AD8566ARMZ-REEL <sup>1</sup>	-40°C to +85°C	8-Lead Micro Small Outline Package (MSOP)	RM-8	ATA#
AD8567ARU	-40°C to +85°C	14-Lead Thin Shrink Small Outline Package (TSSOP)	RU-14	
AD8567ARU-REEL	-40°C to +85°C	14-Lead Thin Shrink Small Outline Package (TSSOP)	RU-14	
AD8567ARUZ <sup>1</sup>	-40°C to +85°C	14-Lead Thin Shrink Small Outline Package (TSSOP)	RU-14	
AD8567ARUZ-REEL <sup>1</sup>	-40°C to +85°C	14-Lead Thin Shrink Small Outline Package (TSSOP)	RU-14	
AD8567ACP-R2	-40°C to +85°C	16-Lead Lead Frame Chip Scale Package (LFCSF_VQ)	CP-16-4	
AD8567ACP-REEL	-40°C to +85°C	16-Lead Lead Frame Chip Scale Package (LFCSF_VQ)	CP-16-4	
AD8567ACP-REEL7	-40°C to +85°C	16-Lead Lead Frame Chip Scale Package (LFCSF_VQ)	CP-16-4	
AD8567ACPZ-R2 <sup>1</sup>	-40°C to +85°C	16-Lead Lead Frame Chip Scale Package (LFCSF_VQ)	CP-16-4	
AD8567ACPZ-REEL <sup>1</sup>	-40°C to +85°C	16-Lead Lead Frame Chip Scale Package (LFCSF_VQ)	CP-16-4	
AD8567ACPZ-REEL7 <sup>1</sup>	-40°C to +85°C	16-Lead Lead Frame Chip Scale Package (LFCSF_VQ)	CP-16-4	

<sup>1</sup> Z = Pb-free part, # denotes lead-free product may be top or bottom marked.

**AD8565/AD8566/AD8567**

[查询"AD8567ACP-REEL7"供应商](#)

## NOTES

## NOTES

**AD8565/AD8566/AD8567**

[查询"AD8567ACP-REEL7"供应商](#)

## NOTES