

6 PIN DIP PHOTOTRANSISTOR PHOTOCOUPLER

4N2X Series
4N3X Series
H11AX Series

Features:

- 4N2X series: 4N25, 4N26, 4N27, 4N28
- 4N3X series: 4N35, 4N36, 4N37, 4N38
- H11AX series: H11A1, H11A2, H11A3, H11A4, H11A5
- High isolation voltage between input and output
(Viso=5000 V rms)
- Creepage distance >7.6mm
- Operating temperature up to +110°C
- Compact dual-in-line package
- Pb free and RoHS compliant.
- UL approved (No. E214129)
- VDE approved (No. 132249)
- SEMKO approval pending
- NEMKO approval pending
- DEMKO approval pending
- FIMKO approval pending
- CSA approval pending



Schematic

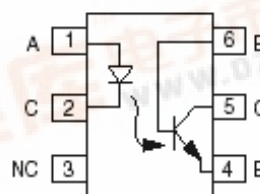

1. Anode
2. Cathode
3. No Connection
4. Emitter
5. Collector
6. Base

Description

The 4N2X, 4N3X, H11AX series contains an infrared emitting diode optically coupled to a phototransistor. It is packaged in a 6-pin DIP package and available in wide-lead spacing and SMD option.

Applications

- Power supply regulators
- Digital logic inputs
- Microprocessor inputs

6 PIN DIP PHOTOTRANSISTOR PHOTOCOUPLER

4N2X Series
4N3X Series
H11AX Series

Absolute Maximum Ratings (T_a=25°C)

Parameter		Symbol	Rating	Unit
Input	Forward current	I _F	50	mA
	Peak forward current (t = 10μs)	I _{FM}	1	A
	Reverse voltage	V _R	6	V
	Power dissipation (T _A = 25°C)	P _D	70	mW
	Derating factor (above 100°C)		3.8	mW/°C
Output	Collector-Emitter voltage	V _{CEO}	80	V
	Collector-Base voltage	V _{CBO}	80	V
	Emitter-Collector voltage	V _{ECO}	7	V
	Emitter-Base voltage	V _{EBO}	7	V
	Power dissipation (T _A = 25°C)	P _C	150	mW
Derating factor (above 100°C)	9.0		mW/°C	
Total power dissipation		P _{tot}	200	mW
Isolation voltage ^{*1}		V _{iso}	5000	V _{rms}
Operating temperature		T _{opr}	-55~+110	°C
Storage temperature		T _{stg}	-55~+125	°C
Soldering temperature ^{*2}		T _{sol}	260	°C

Notes

*1 AC for 1 minute, R.H.= 40 ~ 60% R.H. In this test, pins 1, 2 & 3 are shorted together, and pins 4, 5 & 6 are shorted together.

*2 For 10 seconds.

**6 PIN DIP PHOTOTRANSISTOR
PHOTOCOUPLER**

Electrical Characteristics (T_a=25°C unless specified otherwise)

Input

Parameter	Symbol	Min.	Typ.*	Max.	Unit	Condition
Forward voltage	V _F	-	1.2	1.5	V	I _F = 10mA
Reverse current	I _R	-	-	10	μA	V _R = 6V
Input capacitance	C _{in}	-	30	-	pF	V = 0, f = 1MHz

Output

Parameter	Symbol	Min.	Typ.*	Max.	Unit	Condition
Collector-Base dark current	I _{CBO}	-	-	20	nA	V _{CB} = 10V
Collector-Emitter dark current	I _{CEO}	-	-	50	nA	V _{CE} = 10V, I _F =0mA
		-	-	50		V _{CE} = 60V, I _F =0mA
Collector-Emitter breakdown voltage	BV _{CEO}	80	-	-	V	I _C =1mA
Collector-Base breakdown voltage	BV _{CBO}	80	-	-	V	I _C =0.1mA
Emitter-Collector breakdown voltage	BV _{ECO}	7	-	-	V	I _E =0.1mA
Emitter-Base breakdown voltage	BV _{EBO}	7	-	-	V	I _E =0.1mA
Collector-Emitter capacitance	C _{CE}	-	8	-	pF	V _{CE} =0V, f=1MHz

* Typical values at T_a = 25°C



台湾 EVERLIGHT 供应商

LIGHTING FOREVER

6 PIN DIP PHOTOTRANSISTOR PHOTOCOUPLER

4N2X Series
4N3X Series
H11AX Series

Transfer Characteristics ($T_a=25^\circ\text{C}$ unless specified otherwise)

Parameter		Symbol	Min.	Typ.*	Max.	Unit	Condition
Current transfer ratio	4N35, 4N36, 4N37	CTR	100	-	-	%	$I_F = 10\text{mA}, V_{CE} = 10\text{V}$
	H11A1		50	-	-		
	H11A5		30	-	-		
	4N25, 4N26, 4N38, H11A2, H11A3		20	-	-		
	4N27, 4N28, H11A4		10	-	-		
Collector-Emitter saturation voltage	4N25, 4N26, 4N27, 4N28	$V_{CE(sat)}$	-	-	0.5	V	$I_F = 50\text{mA}, I_C = 2\text{mA}$
	4N35, 4N36, 4N37		-	-	0.3		$I_F = 10\text{mA}, I_C = 0.5\text{mA}$
	H11A1, H11A2, H11A3, H11A4, H11A5		-	-	0.4		
	4N38		-	-	1.0		
Isolation resistance		R_{IO}	10^{11}	-	-	Ω	$V_{IO} = 500\text{Vdc}$
Input-output capacitance		C_{IO}	-	0.2	-	pF	$V_{IO} = 0, f = 1\text{MHz}$
Turn-on time	4N25, 4N26, 4N27, 4N28, H11A1, H11A2, H11A3, H11A4, H11A5	Ton	-	3	10	μs	$V_{CC} = 10\text{V}, I_F = 10\text{mA}, R_L = 100\Omega$ See Fig. 11
	4N35, 4N36, 4N37, 4N38		-	10	12		$V_{CC} = 10\text{V}, I_C = 2\text{mA}, R_L = 100\Omega$, See Fig. 11
Turn-off time	4N25, 4N26, 4N27, 4N28, H11A1, H11A2, H11A3, H11A4	Toff	-	3	10	μs	$V_{CC} = 10\text{V}, I_F = 10\text{mA}, R_L = 100\Omega$ See Fig. 11
	4N35, 4N36, 4N37, 4N38		-	9	12		$V_{CC} = 10\text{V}, I_C = 2\text{mA}, R_L = 100\Omega$, See Fig. 11

* Typical values at $T_a = 25^\circ\text{C}$



台湾 4N26M1E V1 供应商

LIGHTING FOREVER

6 PIN DIP PHOTOTRANSISTOR PHOTOCOUPLER

4N2X Series 4N3X Series H11AX Series

Typical Performance Curves

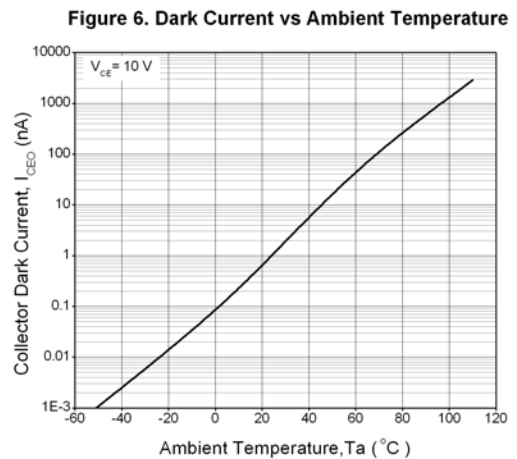
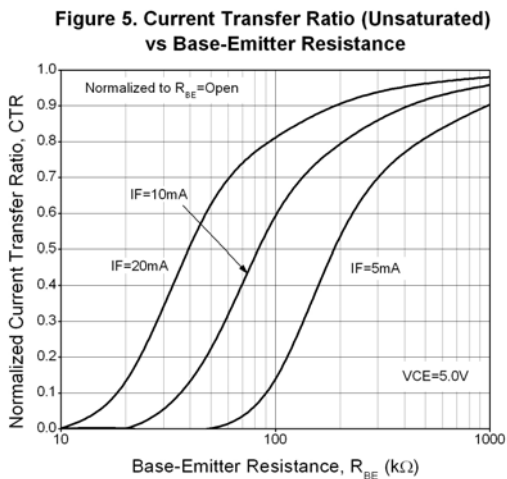
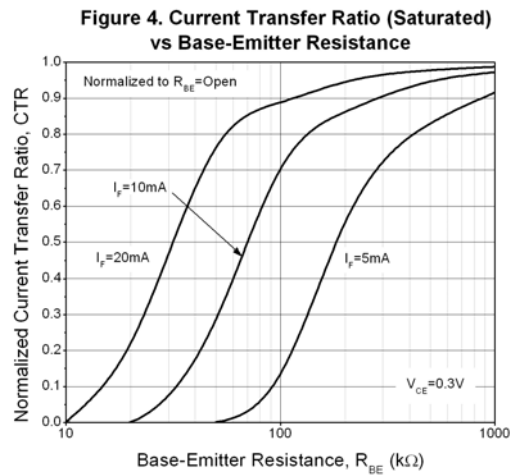
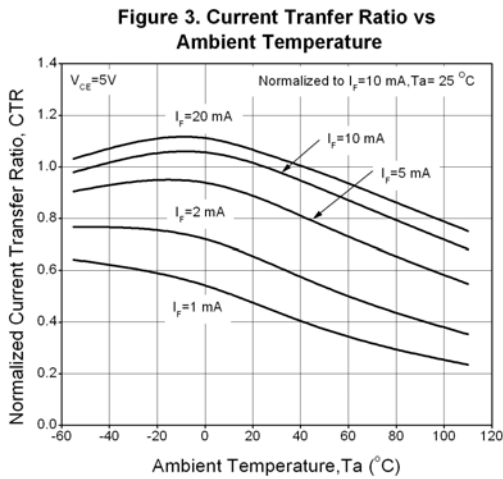
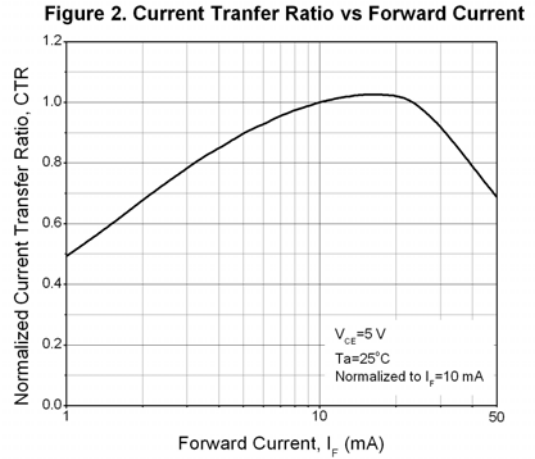
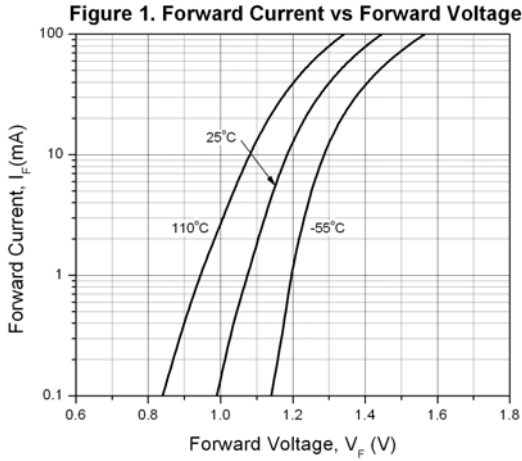

6 PIN DIP PHOTOTRANSISTOR PHOTOCOUPLER

4N2X Series
4N3X Series
H11AX Series

Figure 7. Collector-Emitter Saturation Voltage vs Collector Current

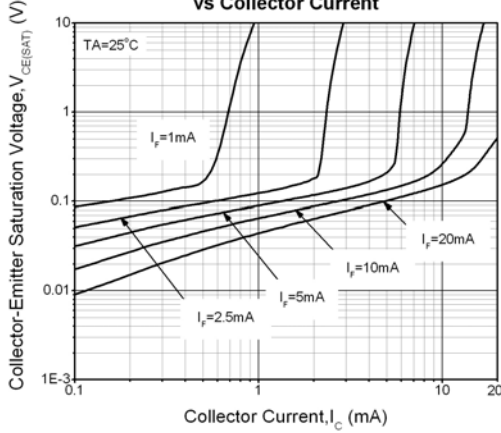

Figure 8. Switching Time vs Load Resistance

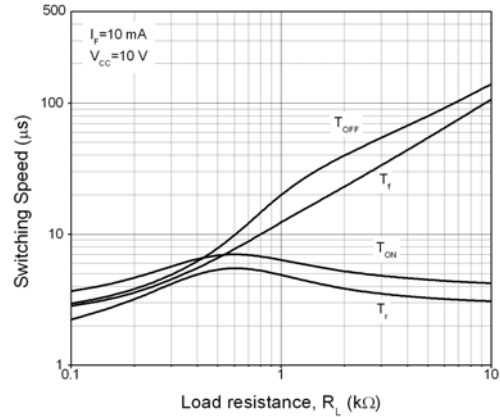

Figure 9. Turn-on Time vs Base-Emitter Resistance

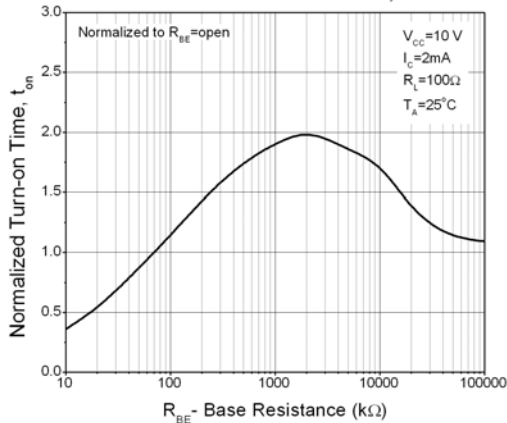

Figure 10. Turn-off Time vs Base-Emitter Resistance

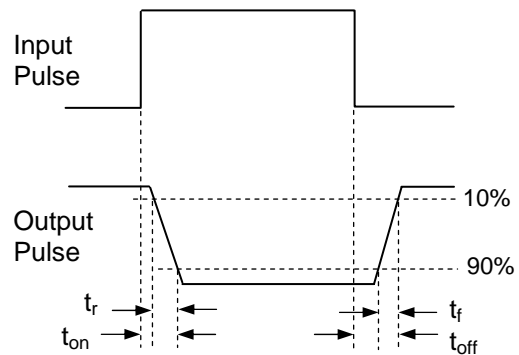
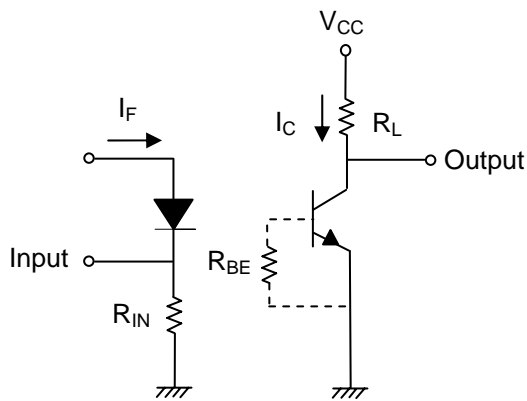
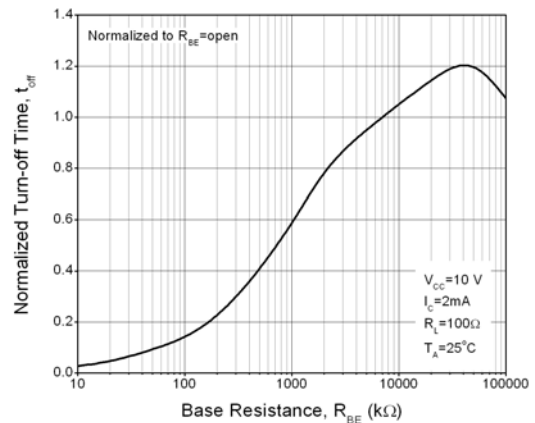

Figure 11. Switching Time Test Circuit & Waveforms

6 PIN DIP PHOTOTRANSISTOR PHOTOCOUPLER

4N2X Series
4N3X Series
H11AX Series

Order Information

Part Number

4NXXY(Z)-V

or

H11AXY(Z)-V

Note

- XX = Part no. for 4NXX series (25, 26, 27, 28, 35, 36, 37 or 38)
- X = Part no. for H11AX series (1, 2, 3, 4, or 5)
- Y = Lead form option (S, S1, M or none)
- Z = Tape and reel option (TA, TB or none).
- V = VDE (optional)

Option	Description	Packing quantity
None	Standard DIP-6	65 units per tube
M	Wide lead bend (0.4 inch spacing)	65 units per tube
S (TA)	Surface mount lead form + TA tape & reel option	1000 units per reel
S (TB)	Surface mount lead form + TB tape & reel option	1000 units per reel
S1 (TA)	Surface mount lead form (low profile) + TA tape & reel option	1000 units per reel
S1 (TB)	Surface mount lead form (low profile) + TB tape & reel option	1000 units per reel

6 PIN DIP PHOTOTRANSISTOR PHOTOCOUPLER

4N2X Series
4N3X Series
H11AX Series

Package Drawings

(Dimensions in mm)

Standard DIP Type

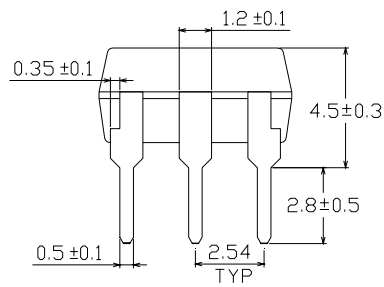
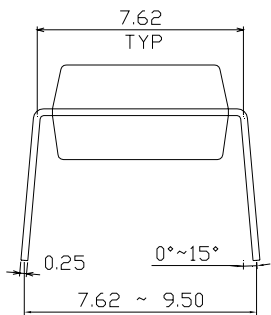
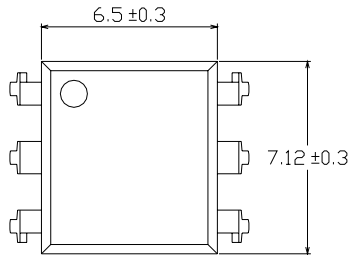

Option M Type

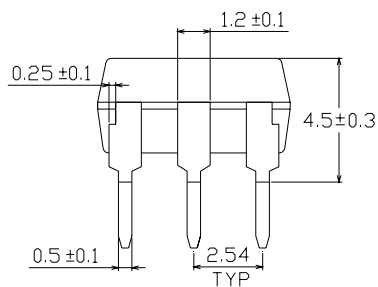
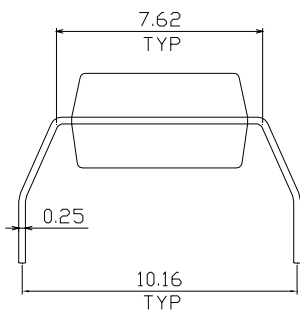
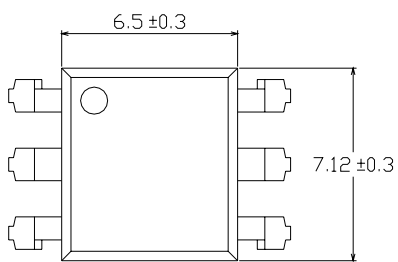



台湾 EVERLIGHT 供应商

LIGHTING FOREVER

6 PIN DIP PHOTOTRANSISTOR PHOTOCOUPLER

4N2X Series
4N3X Series
H11AX Series

Option S Type

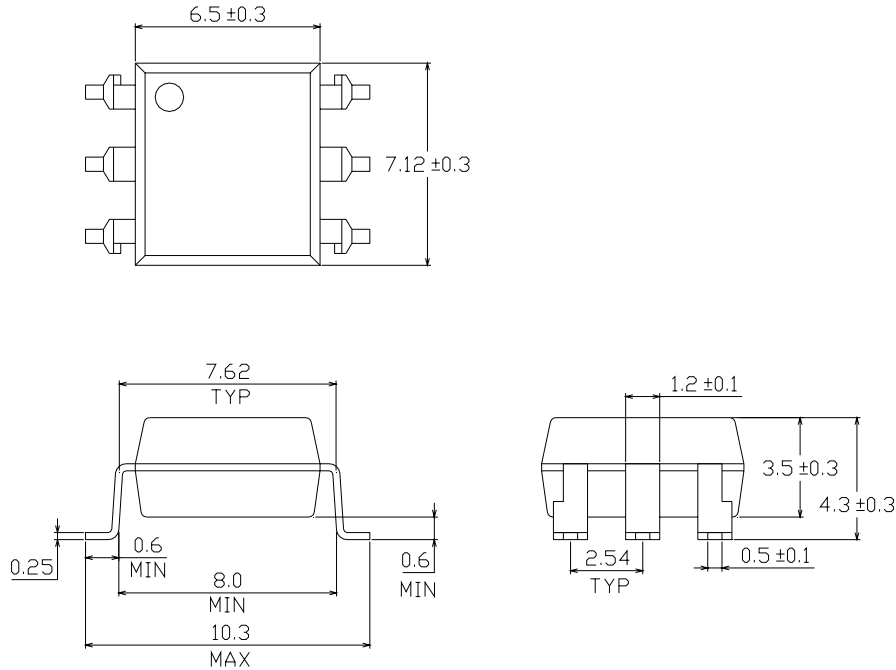

Option S1 Type

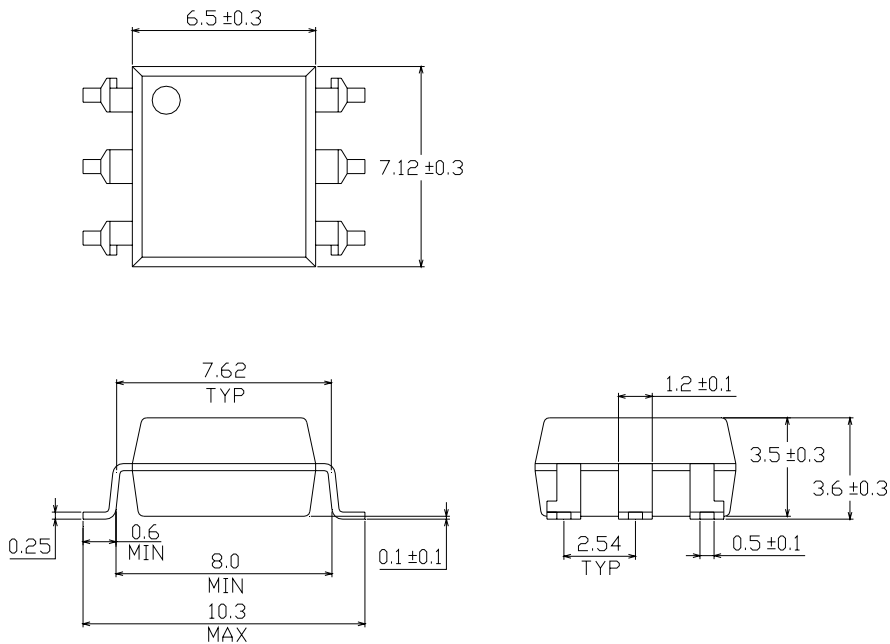



台湾 4N26M1EV 供应商

LIGHTING FOREVER

6 PIN DIP PHOTOTRANSISTOR PHOTOCOUPLER

4N2X Series
4N3X Series
H11AX Series

Device Marking

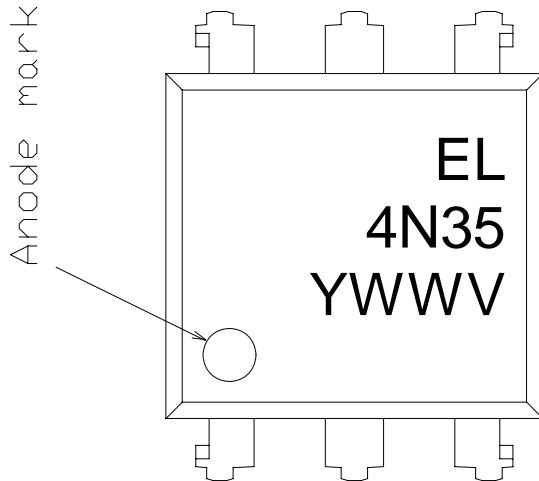

Notes

- EL denotes Everlight
- 4N35 denotes Device Number
- Y denotes 1 digit Year code
- WW denotes 2 digit Week code
- V denotes VDE (optional)

6 PIN DIP PHOTOTRANSISTOR PHOTOCOUPLER

4N2X Series
4N3X Series
H11AX Series

Tape & Reel Packing Specifications

Option TA

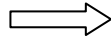
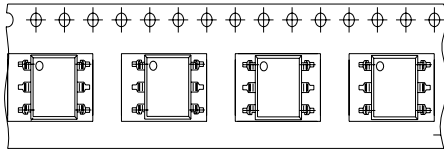

Direction of feed from reel

Option TB

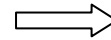
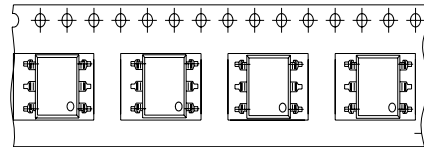

Direction of feed from reel

Tape dimensions

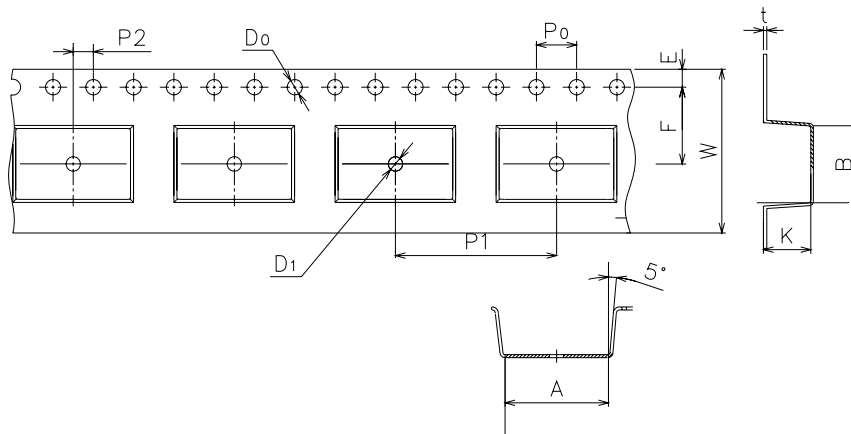

Dimension No.	A	B	Do	D1	E	F
Dimension (mm)	10.4±0.1	7.52±0.1	1.5±0.1	1.5+0.1/-0	1.75±0.1	7.5±0.1

Dimension No.	Po	P1	P2	t	W	K
Dimension (mm)	4.0±0.15	16.0±0.1	2.0±0.1	0.35±0.03	16.0±0.2	4.5±0.1



台湾 EVERLIGHT 代理商

LIGHTING FOREVER

6 PIN DIP PHOTOTRANSISTOR PHOTOCOUPLER

4N2X Series
4N3X Series
H11AX Series

Solder Reflow Temperature Profile

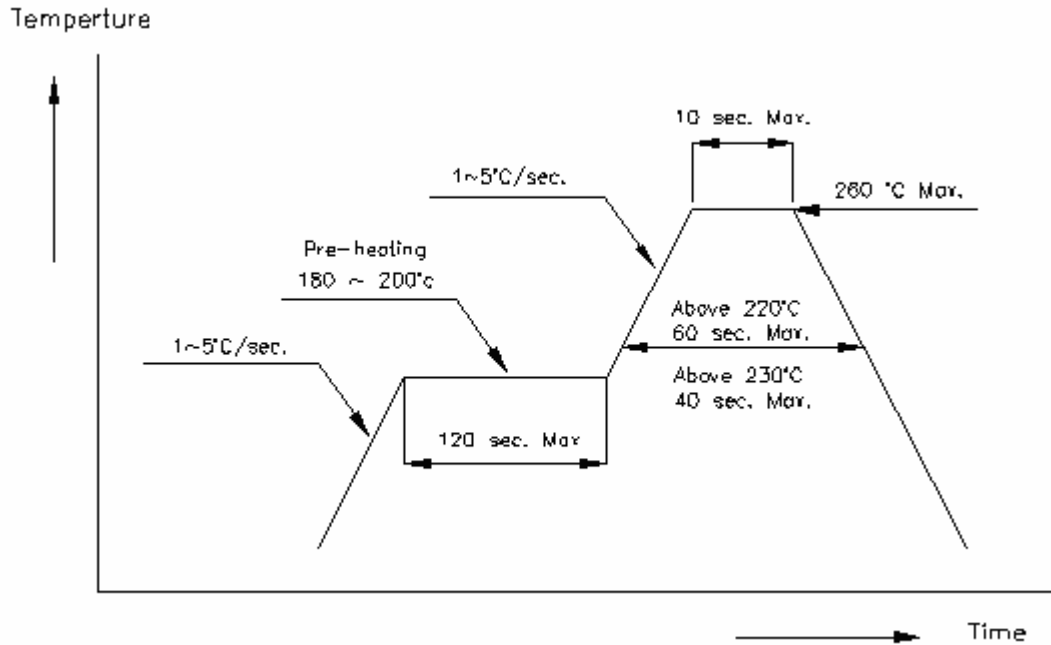



台湾 EVERLIGHT 供应商

LIGHTING FOREVER

6 PIN DIP PHOTOTRANSISTOR PHOTOCOUPLER

4N2X Series
4N3X Series
H11AX Series

DISCLAIMER

1. Above specification may be changed without notice. EVERLIGHT will reserve authority on material change for above specification.
2. When using this product, please observe the absolute maximum ratings and the instructions for use as outlined in these specification sheets. EVERLIGHT assumes no responsibility for any damage resulting from use of the product which does not comply with the absolute maximum ratings and the instructions included in these specification sheets.
3. These specification sheets include materials protected under copyright of EVERLIGHT Corporation. Please do not reproduce or cause anyone to reproduce them without EVERLIGHT's consent.