

135 3810

**AMP**

135 3860

查询"206036-2"供应商

**CPC Connectors  
Series 3**

Specifications subject to change.  
For latest design specifications...  
1-800-522-6752

Dimensioning:  
Dimensions are in inches and millimeters.  
Values in brackets are metric equivalents.

Part numbers listed are for connectors only; order contacts separately.

- Related Product Data:**  
 Contacts-pages 2004 through 2011  
 Contact Arrangements-page 2086  
 Component Dimensions-page 2087  
 Accessories-pages 2090 through 2097  
 Performance Characteristics-page 2074  
 Application Tooling-pages 2012 and 2013  
 Technical Documents-page 2112

**Standard Sex Connectors**

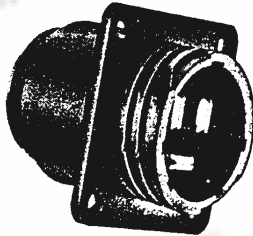

**Square Flange Receptacle**  
(Accepts Type XII Male Pins)



**Free-Hanging Receptacle**  
(Accepts Type XII Male Pins)

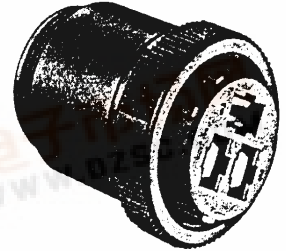

**Plug**  
(Accepts Type XII Female Sockets)

Arrangement	Square Flange Receptacle	Free-Hanging Receptacle	Plug
17-3	206036-2	206207-1	206037-2
23-7	206137-1	206137-2	206136-1

**Reverse Sex Connectors**

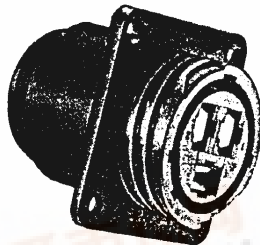

**Square Flange Receptacle**  
(Accepts Type XII Female Sockets)



**Free-Hanging Receptacle**  
(Accepts Type XII Female Sockets)

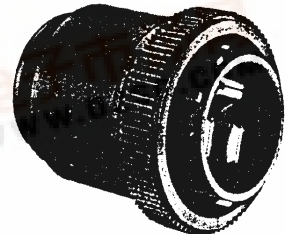

**Plug**  
(Accepts Type XII Male Pins)

Arrangement	Square Flange Receptacle	Free-Hanging Receptacle	Plug
17-3	206425-1	206425-2	206426-1
23-7	206227-1	206227-2	206226-1

**Replacement Coupling Rings Available**

Shell Size	Part No.
17	205958-1
23	206251-1

Note: Maximum wire insulation dia. is .220 [5.59].



## Contact Arrangements Series 3

Specifications subject to change.  
For latest design specifications...  
1-800-522-6752

Dimensioning:  
Dimensions are in inches and millimeters.  
Values in brackets are metric equivalents.

### Shell Size 17

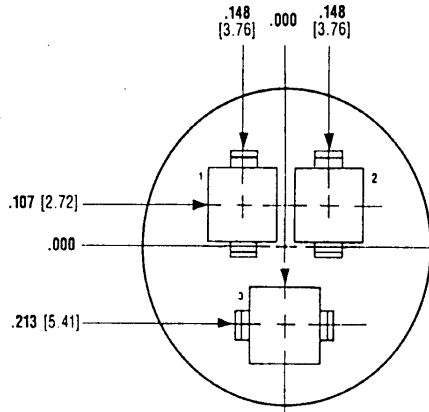

Arrangement 17-3  
Max. Wire Ins. Dia. = .220 [5.59]

### Shell Size 23

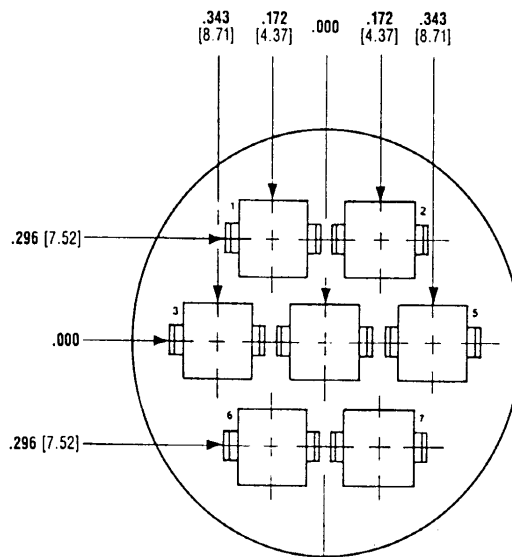

Arrangement 23-7  
Max. Wire Ins. Dia. = .220 [5.59]

Note: Contact arrangements shown are of pin mating face (plug or receptacle). Socket mating face is mirror image.

Specifications subject to change.  
For latest design specifications...  
1-800-522-6752

**Component Dimensions  
Series 3**

**Dimensioning:**  
Dimensions are in inches and millimeters.  
Values in brackets are metric equivalents.  
Chart contains dimensions in inches over  
millimeters.

**Square Flange Receptacle**

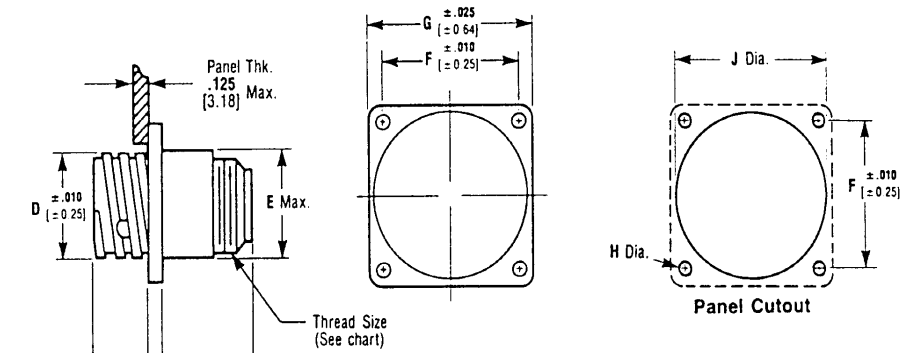

**Free-Hanging Receptacle**

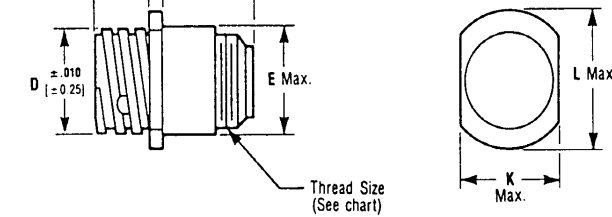

**Plug**

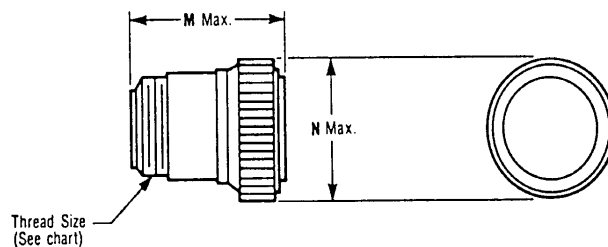

Arrangement No.	Dimensions													Thread Size
	A	B	C	D	E	F	G	H	J	K	L	M	N	
17-3	1.635 41.53	.420 10.67	.094 2.39	1.050 26.67	1.110 28.19	1.125 28.58	1.435 36.45	.150 3.81	1.210 30.73	1.161 29.49	1.310 33.27	1.645 41.78	1.315 33.4	15/16-20 UNE-F-2A
23-7	1.635 41.53	.520 13.21	.156 3.96	1.438 36.53	1.510 38.35	1.438 36.53	1.750 44.45	.150 3.81	1.610 40.89	1.505 38.23	1.733 44.02	1.645 41.78	1.743 44.27	1-3/8-18 UNE-F-2A

Note: All dimensions apply to both standard and reverse sex.