

SAW Bandpass Filter 251905B

1. Features

- IF bandpass filter
- High attenuation
- Single-ended operation
- DIP Package
- Maximum Storage Temperature Range : -40°C ~ 85°C
- Electrostatics Sensitive Device (ESD)

2. Package Dimension

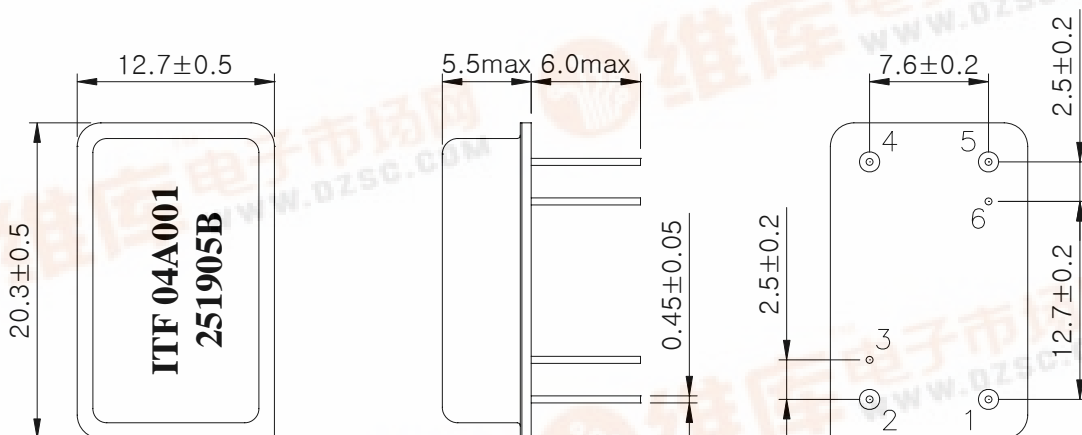

Package : D2012

Dimensions shown are nominal in millimeters

Base : Fe(SPCC), Au plating over Ni plated

Cap : Cu & Cr Alloy, Ni Plated

Termination : Kovar, Au Plated

Pin Configuration	
1	Input
5	Output
2, 4	Ground
3, 6	Case ground

	ITF Co., Ltd. 102-901, Bucheon Technopark 364, Samjeong-Dong, Ojeong-Gu, Bucheon-City, Gyeonggi-Do, Korea 421-809	Part No.	251905B	
		Rev. Date	2004-09-23	
		Rev.	NM4017- CS03	1/5

SAW Bandpass Filter 251905B

3. Specifications

Fo = 190.0 MHz

Terminating source impedance : 50Ω and matching network

Terminating load impedance : 50Ω and matching network

		Minimum	Typical	Maximum
Center Frequency	MHz	189.9	190.0	190.1
Insertion Loss	dB	-	26.0	28.0
1dB Bandwidth	MHz	-	19.0	-
3dB Bandwidth	MHz	19.0	19.4	-
50dB Bandwidth	MHz	-	21.3	21.6
Amplitude Ripple (Fo +/- 9.375 MHz)	dB	-	0.7	1.2
Group Delay Variation (Fo +/- 9.375 MHz)	nsec	-	50	100
Absolute Delay	usec	-	2.85	-
Ultimate Rejection	dB	48	52	-
Temperature Coefficient of Frequency	ppm/°C	-	-23	-

Notes :

- 1) All specifications are based on the matching schematic shown below
- 2) All specifications are measured by Agilent Network analyzer and full 2 port calibration at room temperature
- 3) All attenuation measurements are measured relative to insertion loss

 Integrated Technology Future	ITF Co., Ltd. 102-901, Bucheon Technopark 364, Samjeong-Dong, Ojeong-Gu, Bucheon-City, Gyeonggi-Do, Korea 421-809	Part No.	251905B	
		Rev. Date	2004-09-23	
		Rev.	NM4017- CS03	2/5

SAW Bandpass Filter 251905B

4. Matching Schematic

(Actual matching values may vary due to PCB layout and parasitics)

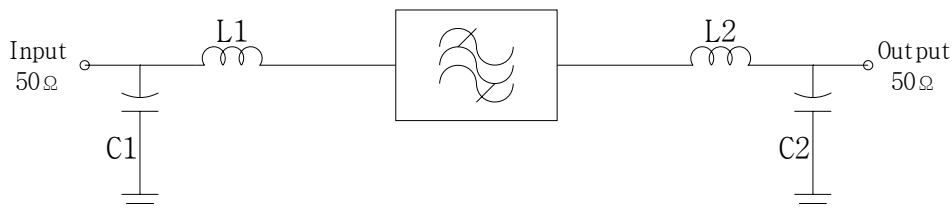

L1 = 33 nH, L2 = 27 nH
 C1 = 36 pF, C2 = 43 pF

5. Marking Configuration

ITF¹⁾04A001²⁾
 251905B³⁾

- 1) Manufacturer name
- 2) Lot Number
- 3) Part Number

	ITF Co., Ltd. 102-901, Bucheon Technopark 364, Samjeong-Dong, Ojeong-Gu, Bucheon-City, Gyeonggi-Do, Korea 421-809	Part No.	251905B	
		Rev. Date	2004-09-23	
		Rev.	NM4017- CS03	3/5

SAW Bandpass Filter 251905B



6. Typical Performance (at +25°C)

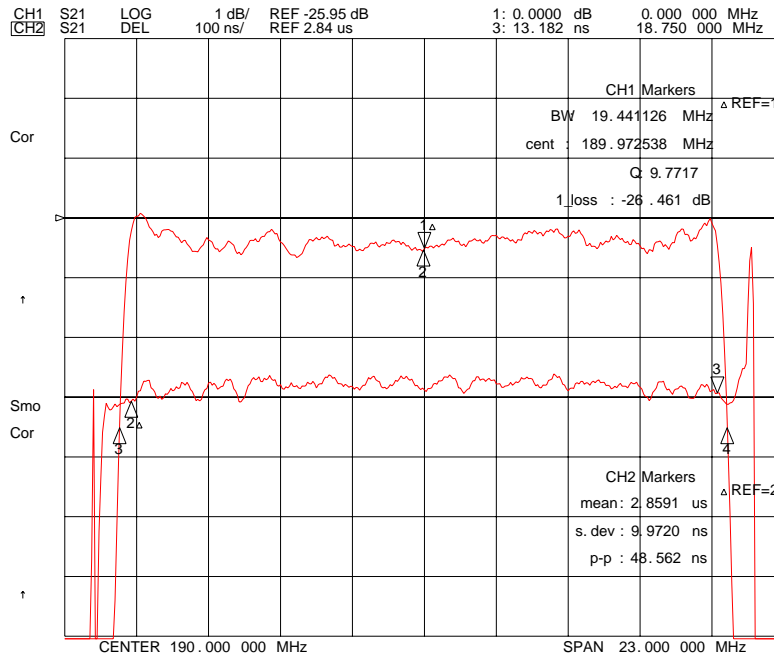
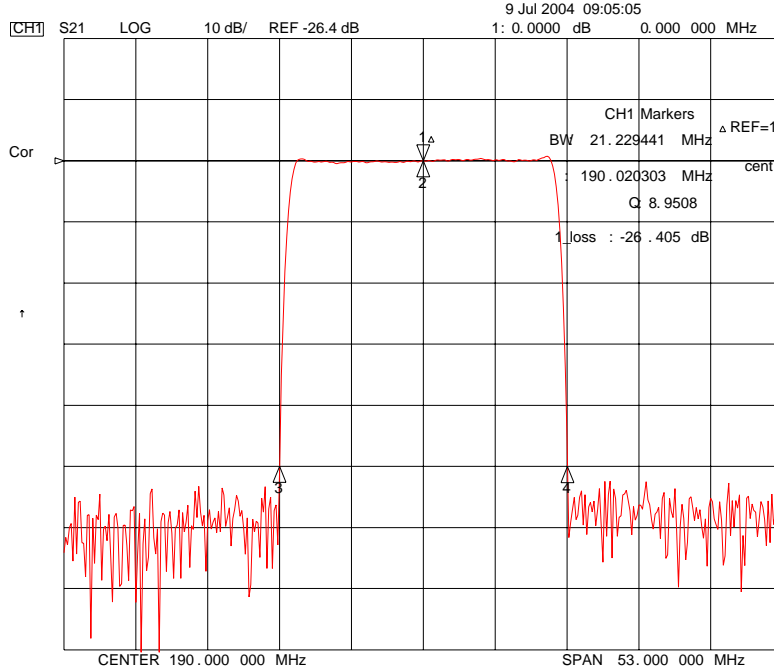

	ITF Co., Ltd. 102-901, Bucheon Technopark 364, Samjeong-Dong, Ojeong-Gu, Bucheon-City, Gyeonggi-Do, Korea 421-809	Part No.	251905B	
		Rev. Date	2004-09-23	
		Rev.	NM4017- CS03	4/5

SAW Bandpass Filter 251905B

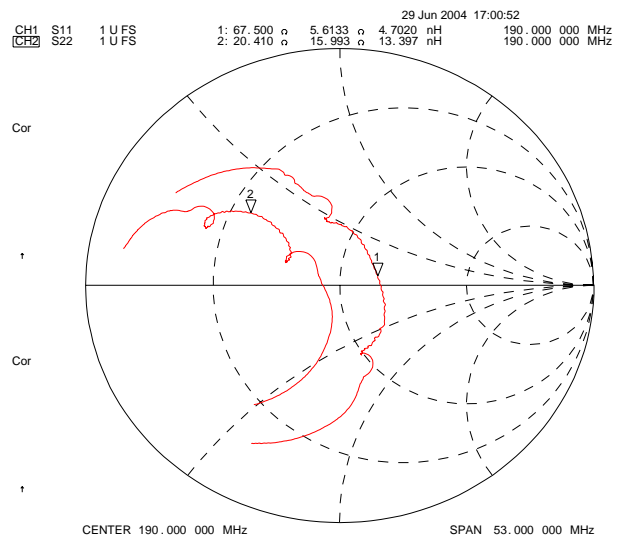
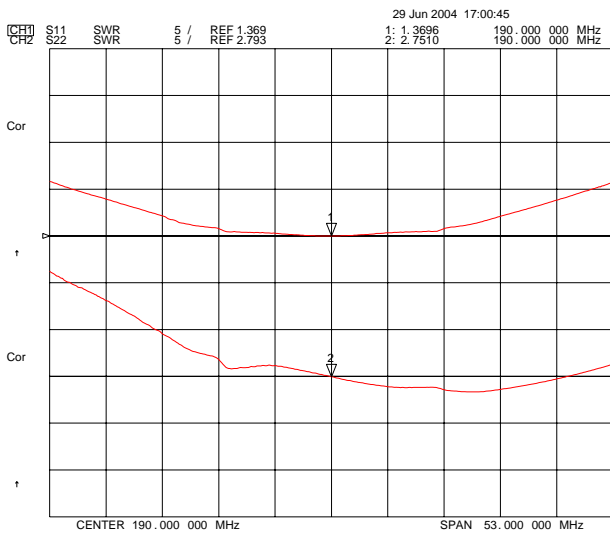
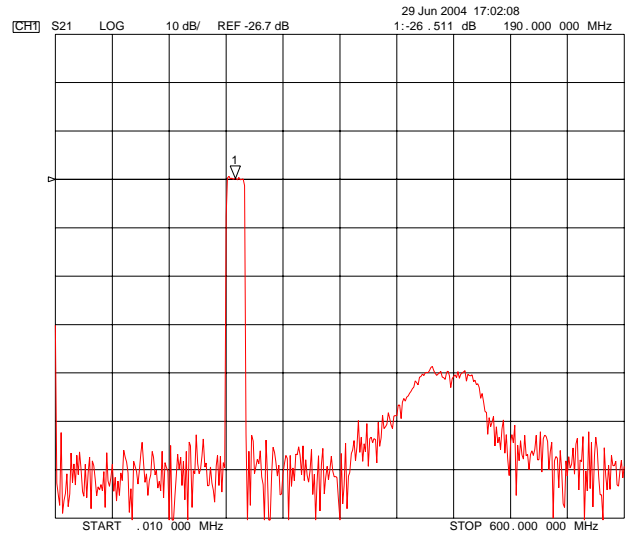
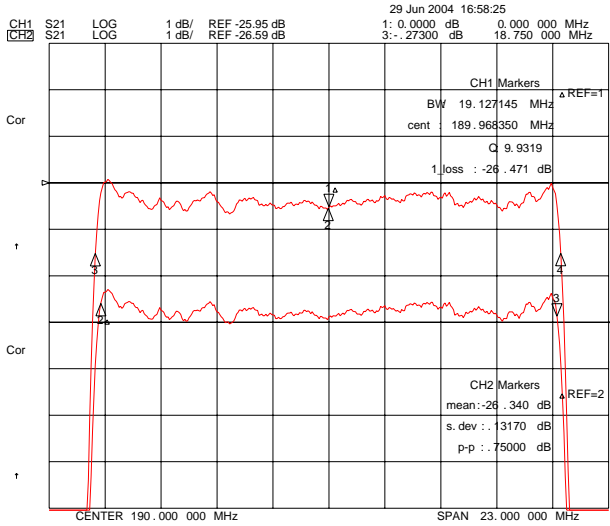

ITF Co., Ltd.
 102-901, Bucheon Technopark 364,
 Samjeong-Dong, Ojeong-Gu, Bucheon-City,
 Gyeonggi-Do, Korea 421-809

Part No.	251905B	
Rev. Date	2004-09-23	
Rev.	NM4017- CS03	5/5