

2SK3588-01L,S,SJ

查询"2SK3588-01L"供应商
FUJI POWER MOSFET
Super FAP-G Series

N-CHANNEL SILICON POWER MOSFET

Features

- High speed switching
- Low on-resistance
- No secondary breakdown
- Low driving power
- Avalanche-proof

Applications

- Switching regulators
- UPS (Uninterruptible Power Supply)
- DC-DC converters

Maximum ratings and characteristic Absolute maximum ratings

(Tc=25°C unless otherwise specified)

Item	Symbol	Ratings	Unit
Drain-source voltage	V _{DS}	100	V
	V _{DSX} *5	70	V
Continuous drain current	I _D	±50	A
Pulsed drain current	I _{D(puls)}	±200	A
Gate-source voltage	V _{GS}	±30	V
Non-repetitive Avalanche current	I _{AS} *2	50	A
Maximum Avalanche Energy	E _{AS} *1	465	mJ
Maximum Drain-Source dV/dt	dV _{DS} /dt *4	20	kV/μs
Peak Diode Recovery dV/dt	dV/dt *3	5	kV/μs
Max. power dissipation	P _D	T _a =25°C	1.67
		T _c =25°C	135
Operating and storage temperature range	T _{ch}	+150	°C
	T _{stg}	-55 to +150	°C

*1 L=223μH, V_{CC}=48V *2 T_{ch}≤150°C *3 I_F≤-I_D, -di/dt=50A/μs, V_{CC}≤BV_{DSS}, T_{ch}≤150°C
 *4 V_{DS} ≤ 100V *5 V_{GS}=-30V

Outline Drawings

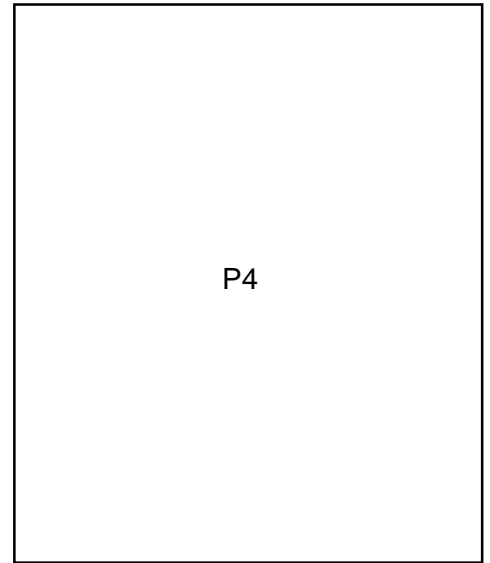

Equivalent circuit schematic

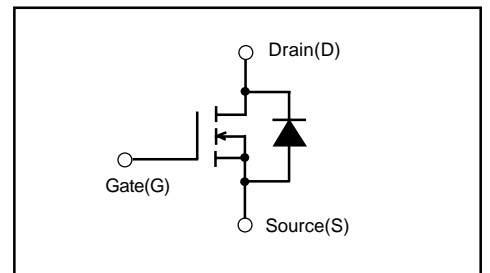

Electrical characteristics (Tc =25°C unless otherwise specified)

Item	Symbol	Test Conditions	Min.	Typ.	Max.	Units
Drain-source breakdown voltage	V _{(BR)DSS}	I _D = 250μA V _{GS} =0V	100			V
Gate threshold voltage	V _{GS(th)}	I _D = 250μA V _{DS} =V _{GS}	3.0		5.0	V
Zero gate voltage drain current	I _{DSS}	V _{DS} =100V V _{GS} =0V V _{DS} =80V V _{GS} =0V	T _{ch} =25°C		25	μA
			T _{ch} =125°C		250	
Gate-source leakage current	I _{GSS}	V _{GS} =±30V V _{DS} =0V		10	100	nA
Drain-source on-state resistance	R _{DS(on)}	I _D =25A V _{GS} =10V		19	25	mΩ
Forward transconductance	g _{fs}	I _D =25A V _{DS} =25V	15	30		S
Input capacitance	C _{iss}	V _{DS} =75V V _{GS} =0V		1830	2745	pF
Output capacitance	C _{oss}			460	690	
Reverse transfer capacitance	C _{rss}		f=1MHz	38	57	
Turn-on time t _{on}	td(on)	V _{CC} =48V I _D =25A V _{GS} =10V		20	30	ns
	t _r			35	53	
Turn-off time t _{off}	td(off)	R _{GS} =10 Ω		50	75	ns
	t _f			23	35	
Total Gate Charge	Q _G	V _{CC} =50V		52	78	nC
Gate-Source Charge	Q _{GS}	I _D =50A		16	24	
Gate-Drain Charge	Q _{GD}	V _{GS} =10V		18	27	
Avalanche capability	I _{AV}	L=100μH T _{ch} =25°C	50			A
Diode forward on-voltage	V _{SD}	I _F =50A V _{GS} =0V T _{ch} =25°C		1.10	1.65	V
Reverse recovery time	t _{rr}	I _F =50A V _{GS} =0V		0.1		μs
Reverse recovery charge	Q _{rr}	-di/dt=100A/μs T _{ch} =25°C		0.4		μC

Thermal characteristics

Item	Symbol	Test Conditions	Min.	Typ.	Max.	Units
Thermal resistance	R _{th(ch-c)}	channel to case			0.926	°C/W
	R _{th(ch-a)}	channel to ambient			75.0	°C/W

[查询"2SK3588-01L"供应商](#)

Characteristics

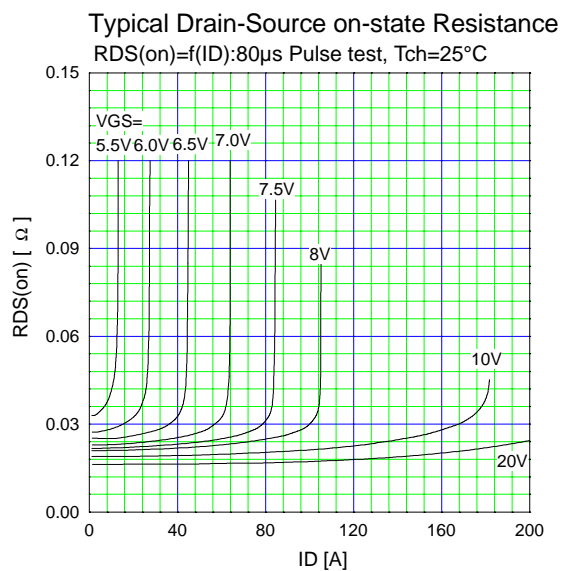
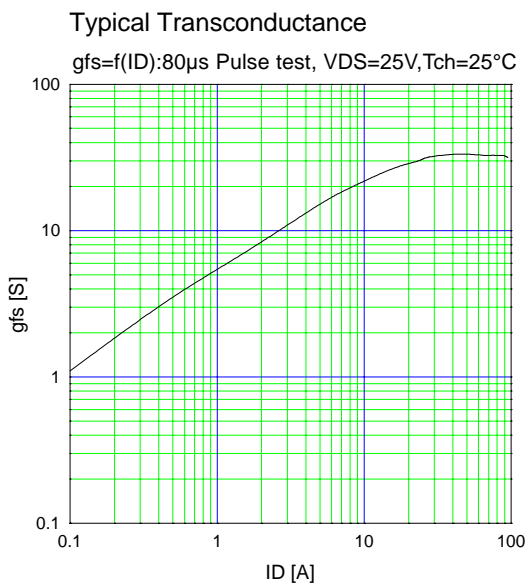
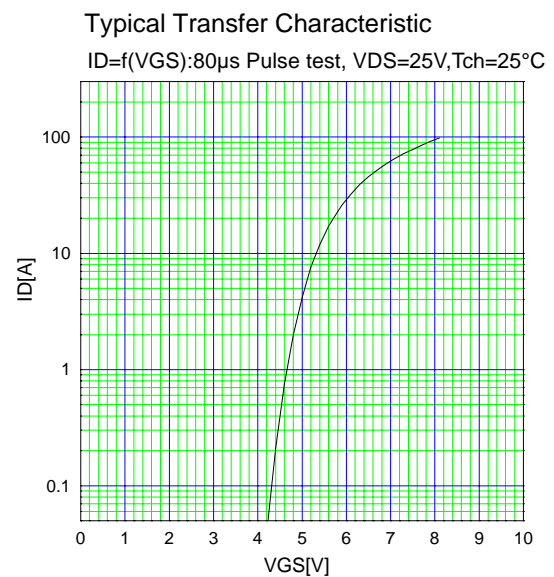
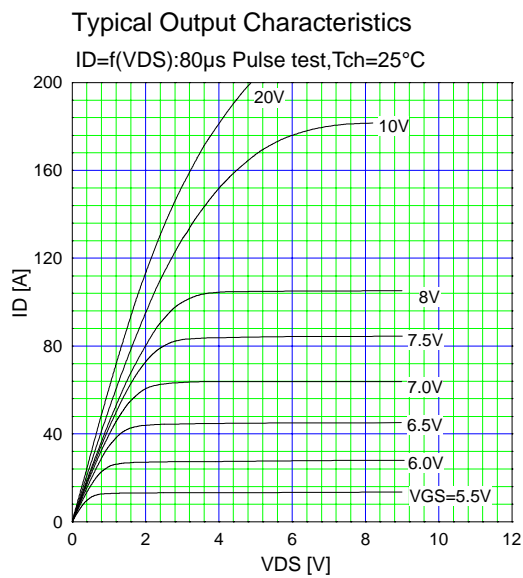
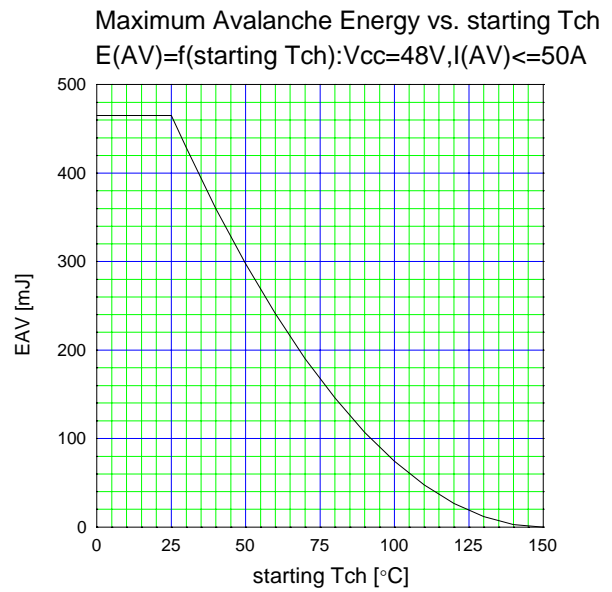
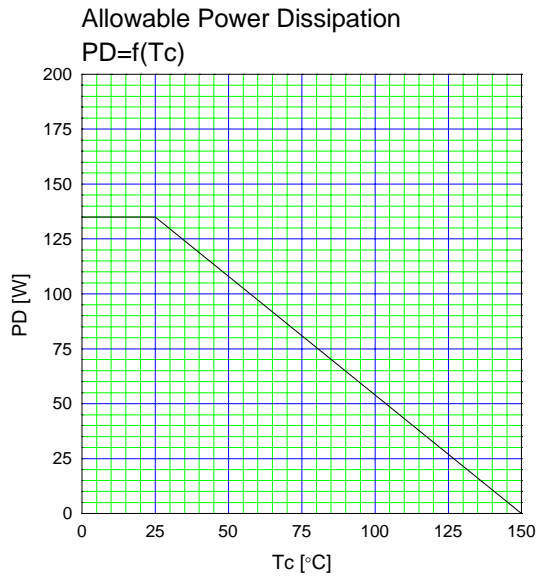

[查询"2SK3588-01L"供应商](#)

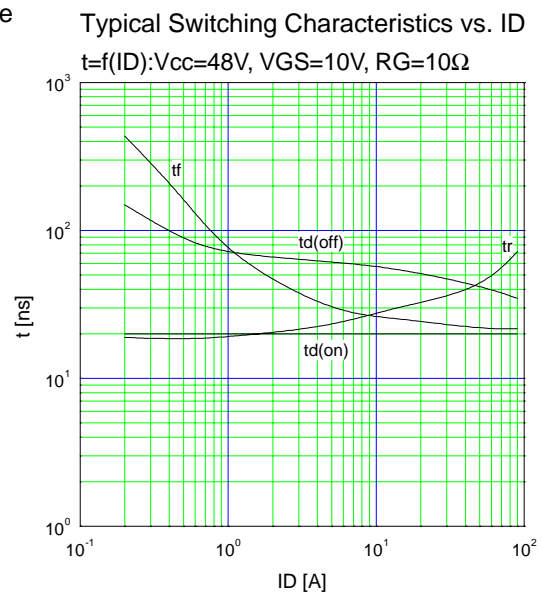
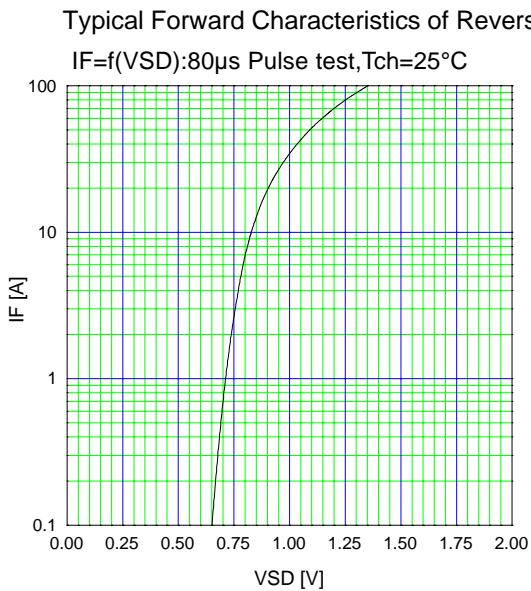
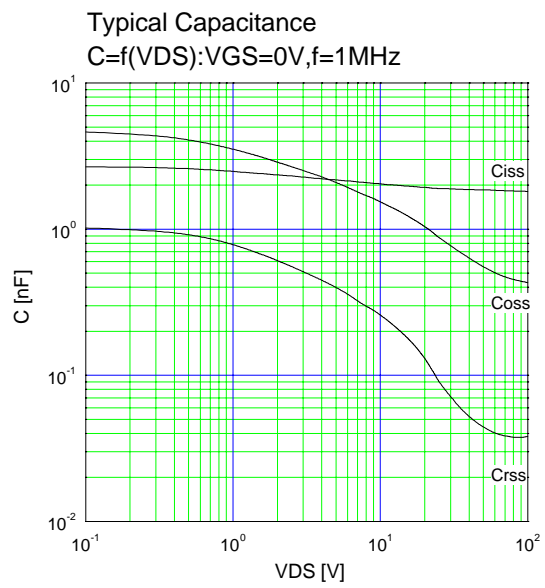
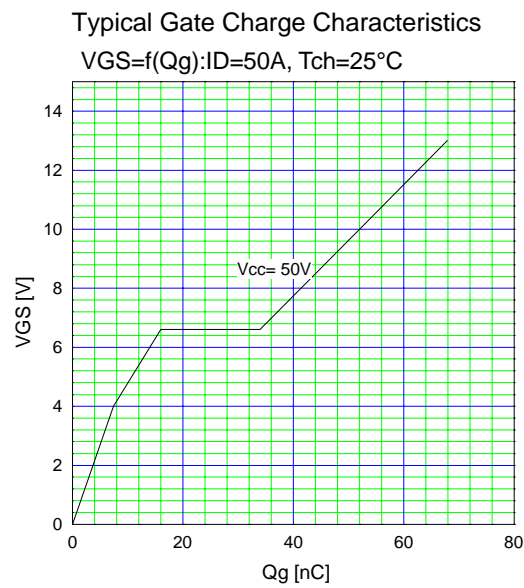
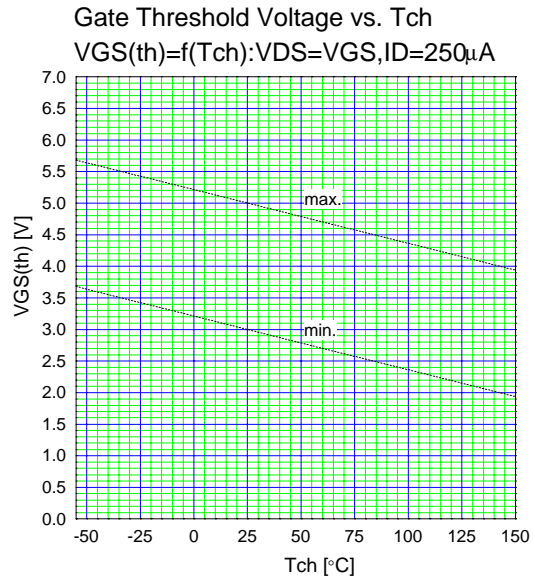
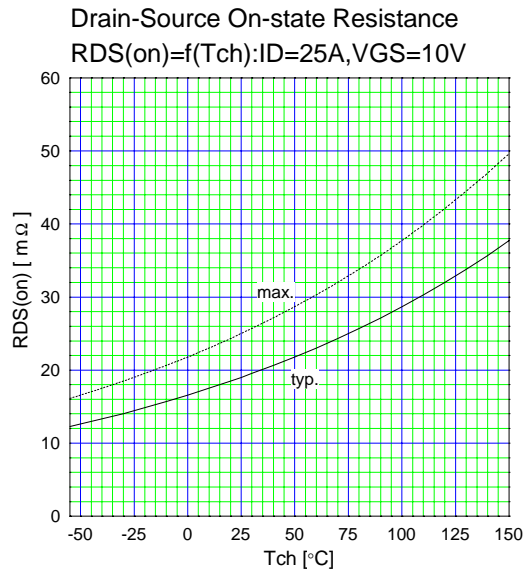

[查询"2SK3588-01L"供应商](#)

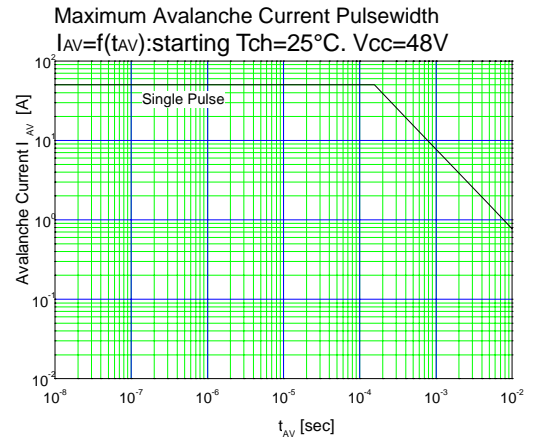
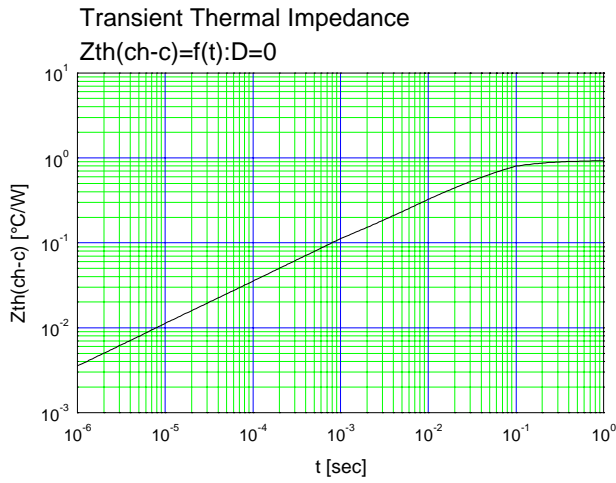

Outline Drawings (mm)

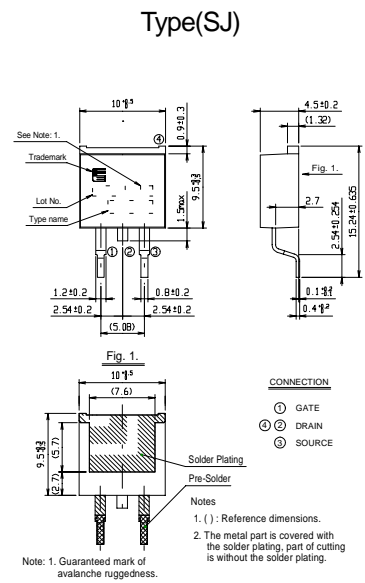
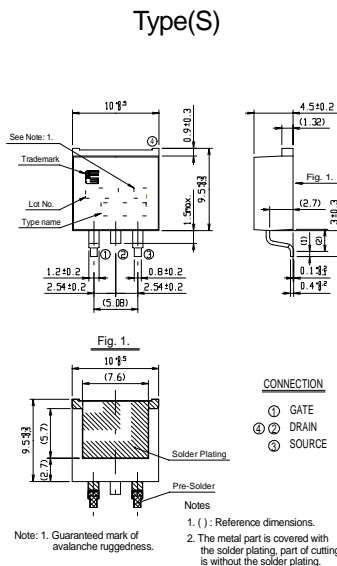
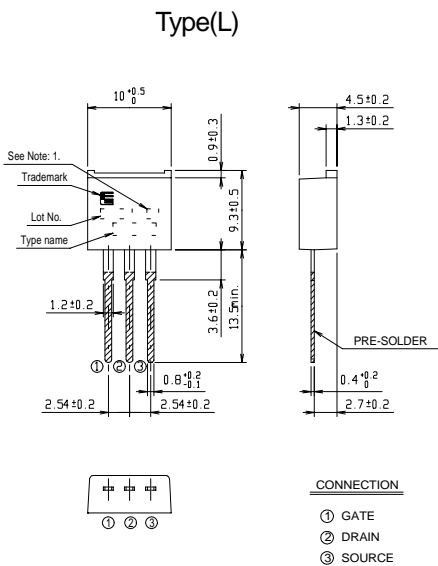

Note: 1. Guaranteed mark of avalanche ruggedness.