



B772SS

PNP SILICON TRANSISTOR

MEDIUM POWER LOW VOLTAGE TRANSISTOR

DESCRIPTION

The UTC B772SS is a medium power low voltage transistor, designed for audio power amplifier, DC-DC converter and voltage regulator.

FEATURES

- * High current output up to 3A
- * Low saturation voltage
- * Complement to D882SS

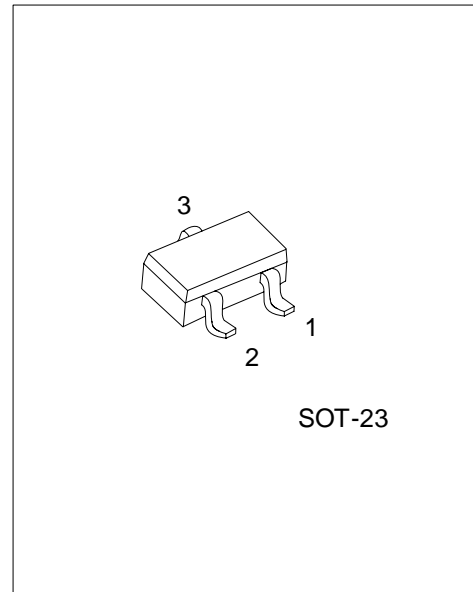

*Pb-free plating product number: B772SSL

ORDERING INFORMATION

Order Number		Package	Pin Assignment			Packing
Normal	Lead Free Plating		1	2	3	
B772SS-x-AE3-R	B772SSL-x-AE3-R	SOT-23	E	B	C	Tape Reel

<p>B772SSL-x-AE3-R</p> <p>(1)Packing Type (2)Package Type (3)Rank (4)Lead Plating</p>	<p>(1) R: Tape Reel (2) AE3: SOT-23 (3) x: refer to Classification of h_{FE2} (4) L: Lead Free Plating, Blank: Pb/Sn</p>
---	---

MARKING

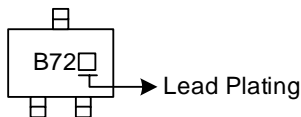

■ ABSOLUTE MAXIMUM RATINGS (Ta = 25)

PARAMETER	SYMBOL	RATINGS	UNIT
Collector-Base Voltage	V _{CB0}	-40	V
Collector-Emitter Voltage	V _{CEO}	-30	V
Emitter-Base Voltage	V _{EBO}	-5	V
Collector Current	Pulse	I _{CP}	-7
	DC	I _C	-3
Base Current	I _B	-0.6	A
Collector Dissipation	T _C =25	P _D	10
	T _a =25		350
Junction Temperature	T _J	+150	
Storage Temperature	T _{STG}	-55 ~ +150	

Note Absolute maximum ratings are those values beyond which the device could be permanently damaged. Absolute maximum ratings are stress ratings only and functional device operation is not implied.

■ ELECTRICAL CHARACTERISTICS (Ta= 25 , unless otherwise specified)

PARAMETER	SYMBOL	TEST CONDITIONS	MIN	TYP	MAX	UNIT
Collector-Base Breakdown Voltage	BV _{CB0}	I _C =-100μA, I _E =0	-40			V
Collector-Emitter Breakdown Voltage	BV _{CEO}	I _C =-1mA, I _B =0	-30			V
Emitter-Base Breakdown Voltage	BV _{EBO}	I _E =-100μA, I _C =0	-5			V
Collector Cut-Off Current	I _{CB0}	V _{CB} =-30V, I _E =0			-1000	nA
Collector Cut-Off Current	I _{CEO}	V _{CE} =-30V, I _B =0			-1000	nA
Emitter Cut-Off Current	I _{EBO}	V _{EB} =-3V, I _C =0			-1000	nA
DC Current Gain(Note 1)	h _{FE1}	V _{CE} =-2V, I _C =-20mA	30	200		
	h _{FE2}	V _{CE} =-2V, I _C =-1A	100	150	400	
Collector-Emitter Saturation Voltage	V _{CE(SAT)}	I _C =-2A, I _B =-0.2A		-0.3	-0.5	V
Base-Emitter Saturation Voltage	V _{BE(SAT)}	I _C =-2A, I _B =-0.2A		-1.0	-2.0	V
Current Gain Bandwidth Product	f _T	V _{CE} =-5V, I _C =-0.1A		80		MHz
Output Capacitance	Cob	V _{CB} =-10V, I _E =0, f=1MHz		45		pF

Note 1: Pulse test: P_w<300μs, Duty Cycle<2%

■ CLASSIFICATION OF h_{FE2}

RANK	Q	P	E
RANGE	100 ~ 200	160 ~ 320	200 ~ 400

TYPICAL CHARACTERISTICS

Static Characteristics

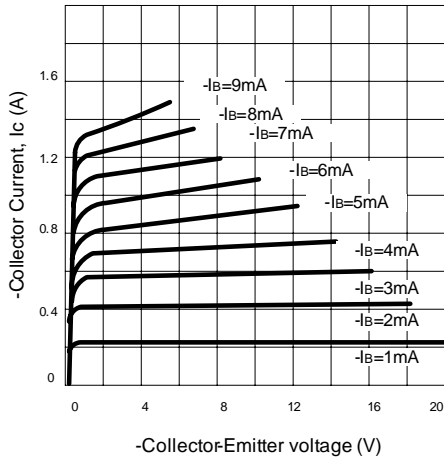

Derating Curve of Safe Operating Areas

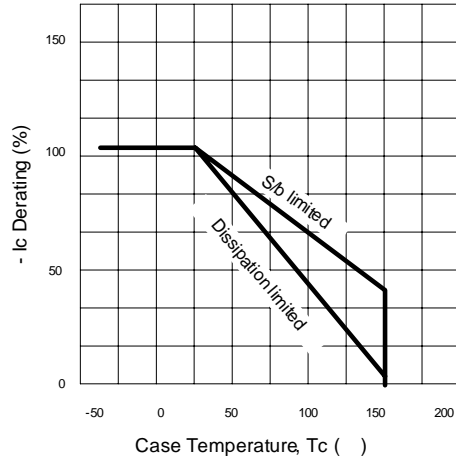

Power Derating

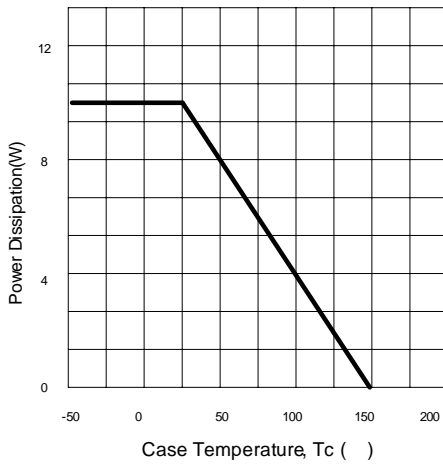

Collector Output Capacitance

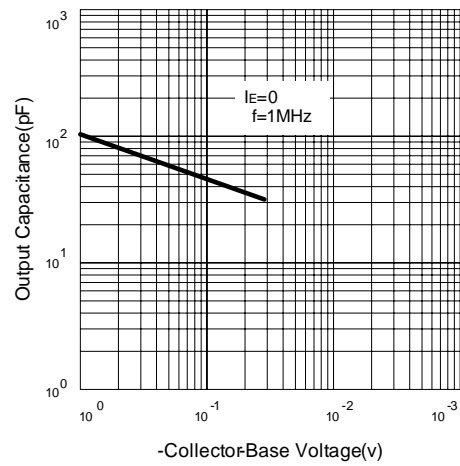

Current Gain - Bandwidth Product

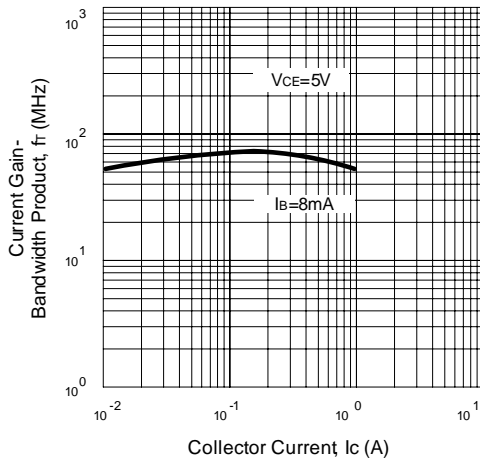

Safe Operating Area

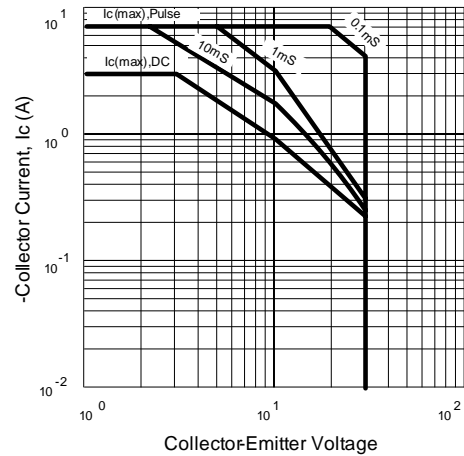

TYPICAL CHARACTERISTICS(Cont.)

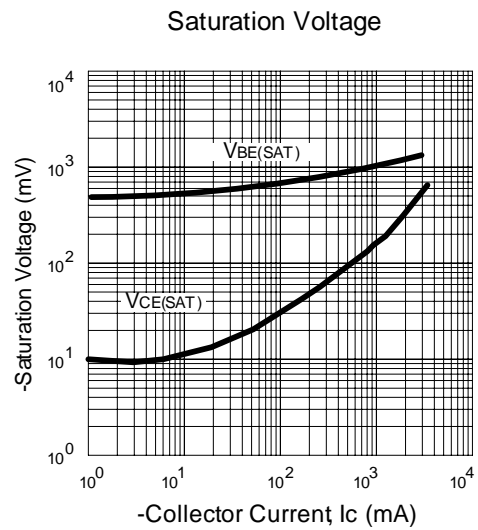
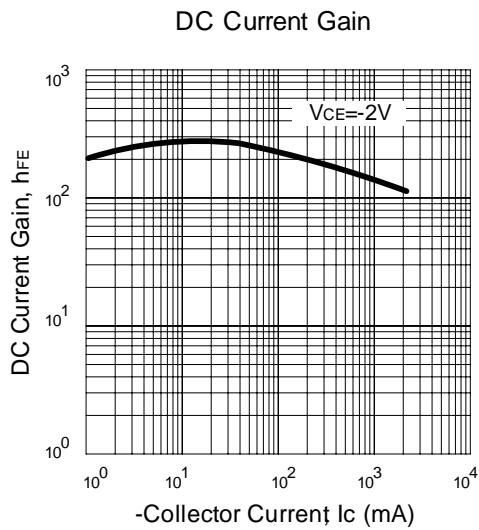

UTC assumes no responsibility for equipment failures that result from using products at values that exceed, even momentarily, rated values (such as maximum ratings, operating condition ranges, or other parameters) listed in products specifications of any and all UTC products described or contained herein. UTC products are not designed for use in life support appliances, devices or systems where malfunction of these products can be reasonably expected to result in personal injury. Reproduction in whole or in part is prohibited without the prior written consent of the copyright owner. The information presented in this document does not form part of any quotation or contract, is believed to be accurate and reliable and may be changed without notice.