

"Half-Bridge" IGBT INT-A-PAK (Ultrafast Speed IGBT), 200 A



INT-A-PAK

FEATURES

- Generation 4 IGBT technology
- Ultrafast: Optimized for high speed 8 kHz to 40 kHz in hard switching, > 200 kHz in resonant mode
- Very low conduction and switching losses
- HEXFRED® antiparallel diodes with ultrasoft recovery
- Industry standard package
- UL approved file E78996
- Compliant to RoHS directive 2002/95/EC
- Designed and qualified for industrial level

**RoHS
COMPLIANT**

PRODUCT SUMMARY

V_{CES}	600 V
I_C DC	265 A
$V_{CE(on)}$ at 200 A, 25 °C	1.74 V

BENEFITS

- Increased operating efficiency
- Direct mounting to heatsink
- Performance optimized for power conversion: UPS, SMPS, welding
- Low EMI, requires less snubbing

ABSOLUTE MAXIMUM RATINGS

PARAMETER	SYMBOL	TEST CONDITIONS	MAX.	UNITS
Collector to emitter voltage	V_{CES}		600	V
Continuous collector current	I_C	$T_C = 25\text{ °C}$	265	A
		$T_C = 67\text{ °C}$	200	
Pulsed collector current	I_{CM}		400	
Peak switching current	I_{LM}		400	
Peak diode forward current	I_{FM}		400	
Gate to emitter voltage	V_{GE}		± 20	V
RMS isolation voltage	V_{ISOL}	Any terminal to case, t = 1 min	2500	
Maximum power dissipation	P_D	$T_C = 25\text{ °C}$	625	W
		$T_C = 85\text{ °C}$	325	

ELECTRICAL SPECIFICATIONS ($T_J = 25\text{ °C}$ unless otherwise specified)

PARAMETER	SYMBOL	TEST CONDITIONS	MIN.	TYP.	MAX.	UNITS
Collector to emitter breakdown voltage	$V_{BR(CES)}$	$V_{GE} = 0\text{ V}, I_C = 1\text{ mA}$	600	-	-	V
Collector to emitter voltage	$V_{CE(on)}$	$V_{GE} = 15\text{ V}, I_C = 200\text{ A}$	-	1.74	2.2	
		$V_{GE} = 15\text{ V}, I_C = 200\text{ A}, T_J = 125\text{ °C}$	-	1.79	2.25	
Gate threshold voltage	$V_{GE(th)}$	$I_C = 0.25\text{ mA}$	3	4.4	6	
Temperature coeff. of threshold voltage	$\Delta V_{GE(th)}/\Delta T_J$	$V_{CE} = V_{GE}, I_C = 0.25\text{ mA}$	-	- 11	-	mV/°C
Forward transconductance	g_{fe}	$V_{CE} = 20\text{ V}, I_C = 200\text{ A}$	-	220	-	S
Collector to emitter leakage current	I_{CES}	$V_{GE} = 0\text{ V}, V_{CE} = 600\text{ V}$	-	0.014	1	mA
		$V_{GE} = 0\text{ V}, V_{CE} = 600\text{ V}, T_J = 125\text{ °C}$	-	-	10	
Diode forward voltage drop	V_{FM}	$I_C = 200\text{ A}, V_{GE} = 0\text{ V}$	-	4.2	6.0	V
		$I_C = 200\text{ A}, V_{GE} = 0\text{ V}, T_J = 125\text{ °C}$	-	4.4	6.2	
Gate to emitter leakage current	I_{GES}	$V_{GE} = \pm 20\text{ V}$	-	-	± 250	nA



GA200TS60UPbF



Vishay High Power Products "Half-Bridge" IGBT INT-A-PAK
(Ultrafast Speed IGBT), 200 A

SWITCHING CHARACTERISTICS (T _J = 25 °C unless otherwise specified)						
PARAMETER	SYMBOL	TEST CONDITIONS	MIN.	TYP.	MAX.	UNITS
Total gate charge	Q _g	I _C = 200 A	-	900	-	nC
Gate to emitter charge	Q _{ge}	I _C = 270 A	-	125	-	
Gate to collector charge	Q _{gc}	V _{GE} = 15 V	-	306	-	
Turn-on delay time	t _{d(on)}	I _C = 200 A V _{CC} = 360 V V _{GE} = ± 15 V T _J = 25 °C	-	220	-	ns
Rise time	t _r		-	154	-	
Turn-off delay time	t _{d(off)}		-	300	-	
Fall time	t _f		-	180	-	
Turn-on switching energy	E _{on}	R _{g1} = 15 Ω R _{g2} = 0 Ω	-	2.2	-	mJ
Turn-off switching energy	E _{off}		-	6.6	-	
Total switching energy	E _{ts}		-	8.8	-	
Turn-on delay time	t _{d(on)}	I _C = 200 A V _{CC} = 360 V V _{GE} = ± 15 V T _J = 125 °C	-	342	-	ns
Rise time	t _r		-	194	-	
Turn-off delay time	t _{d(off)}		-	366	-	
Fall time	t _f		-	213	-	
Turn-on switching energy	E _{on}	R _{g1} = 15 Ω R _{g2} = 0 Ω	-	5	-	mJ
Turn-off switching energy	E _{off}		-	16	-	
Total switching energy	E _{ts}		-	21	-	
Input capacitance	C _{ies}	V _{GE} = 0 V	-	20 068	-	pF
Output capacitance	C _{oes}	V _{CC} = 30 V	-	1254	-	
Reverse transfer capacitance	C _{res}	f = 1.0 MHz	-	261	-	
Diode reverse recovery time	t _{rr}	I _C = 200 A V _{CC} = 360 V di/dt = 1300 A/μs	-	179	-	ns
Diode peak reverse current	I _{rr}		-	120	-	A
Diode recovery charge	Q _{rr}		-	10 714	-	μC
Diode peak rate of fall of recovery during t _b	dl _{(rec)M} /dt		-	1922	-	A/μs

THERMAL AND MECHANICAL SPECIFICATIONS					
PARAMETER	SYMBOL	MIN.	TYP.	MAX.	UNITS
Operating junction temperature range	T _J	- 40	-	150	°C
Storage temperature range	T _{Stg}	- 40	-	125	
Junction to case	IGBT	-	-	0.2	°C/W
	Diode	-	-	0.4	
Case to sink per module	R _{thCS}	-	0.1	-	
Mounting torque	case to heatsink	-	-	4	Nm
	case to terminal 1, 2, 3	-	-	3	
Weight		-	200	-	g

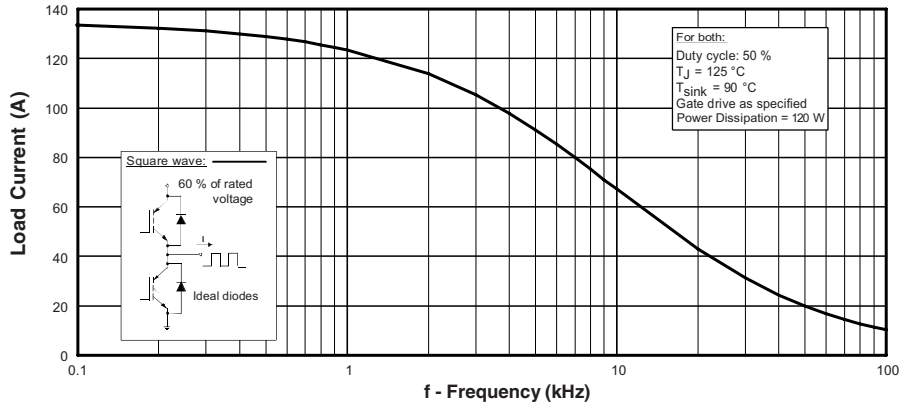

Fig. 1 - Typical Load Current vs. Frequency
 (Load Current = I_{RMS} of Fundamental)

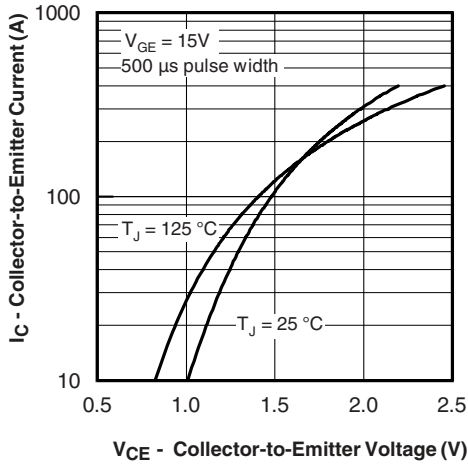

Fig. 2 - Typical Output Characteristics

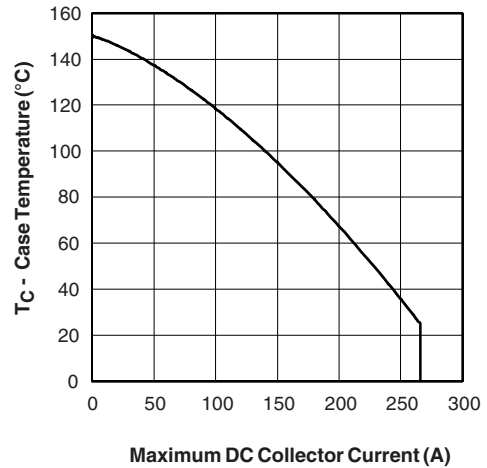

Fig. 4 - Case Temperature vs. Maximum Collector Current

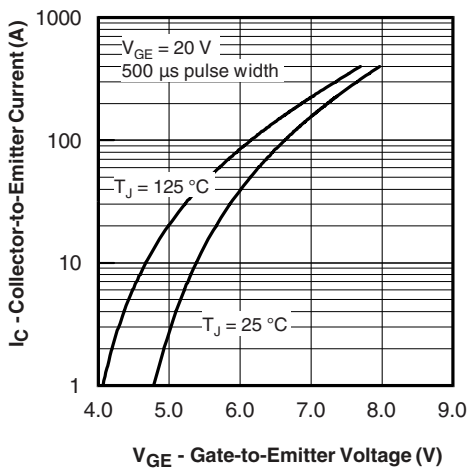

Fig. 3 - Typical Transfer Characteristics

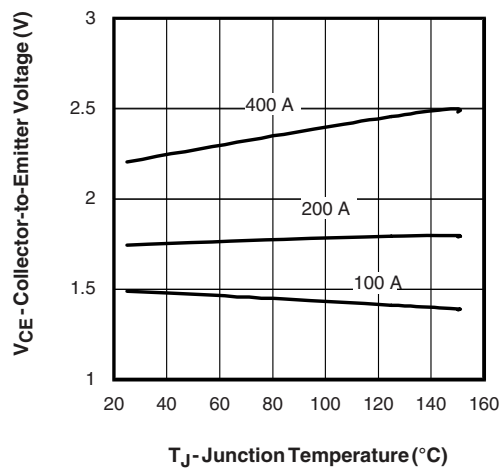

Fig. 5 - Typical Collector to Emitter Voltage vs. Junction Temperature

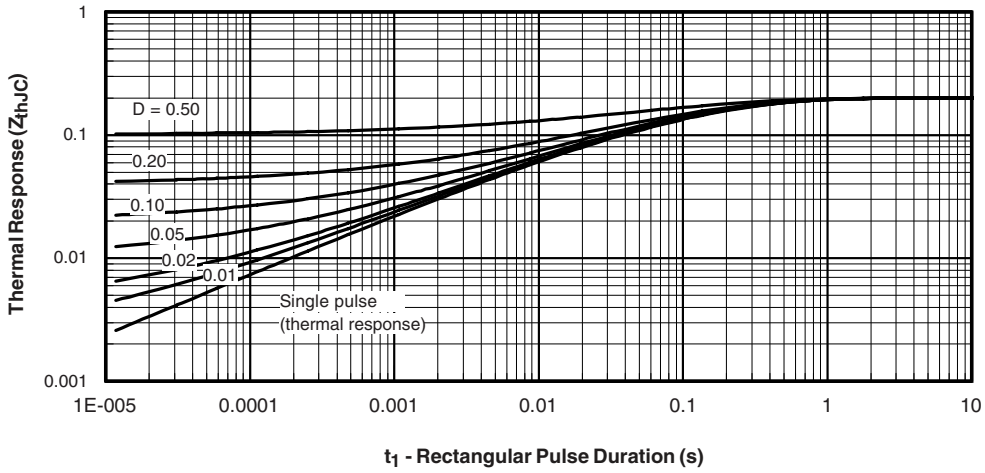

Fig. 6 - Maximum Effective Transient Thermal Impedance, Junction to Case

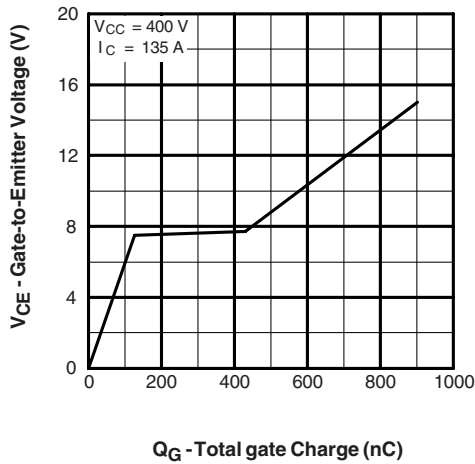

Fig. 7 - Typical Gate Charge vs. Gate to Emitter Voltage

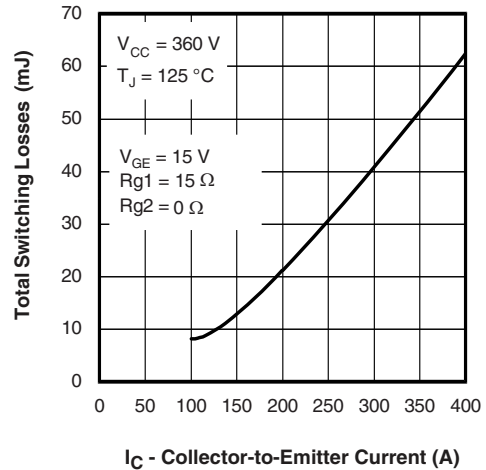

Fig. 9 - Typical Switching Losses vs. Collector to Emitter Current

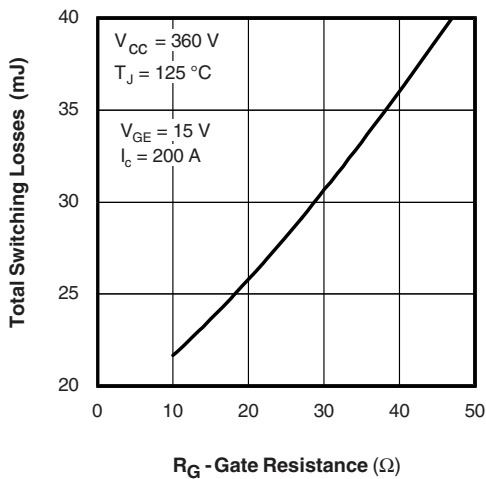

Fig. 8 - Typical Switching Losses vs. Gate Resistance

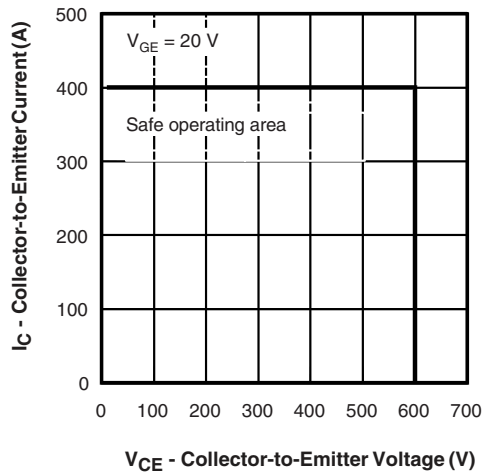

Fig. 10 - Reverse Bias SOA

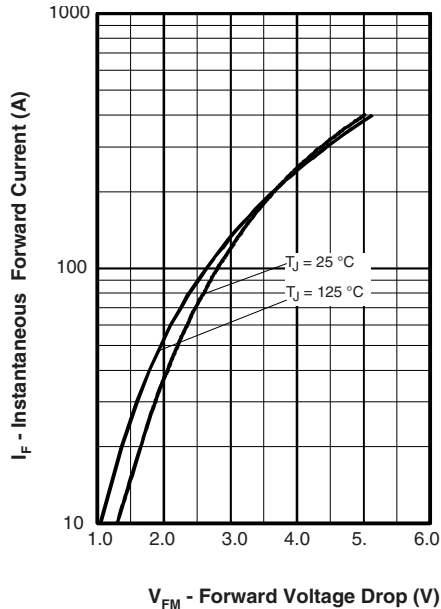

Fig. 11 - Typical Forward Voltage Drop vs. Instantaneous Forward Current

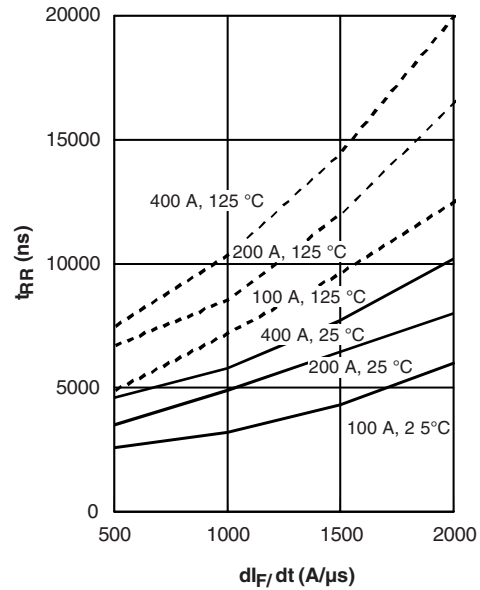

Fig. 13 - Typical Reverse Recovery Time vs. di_F/dt

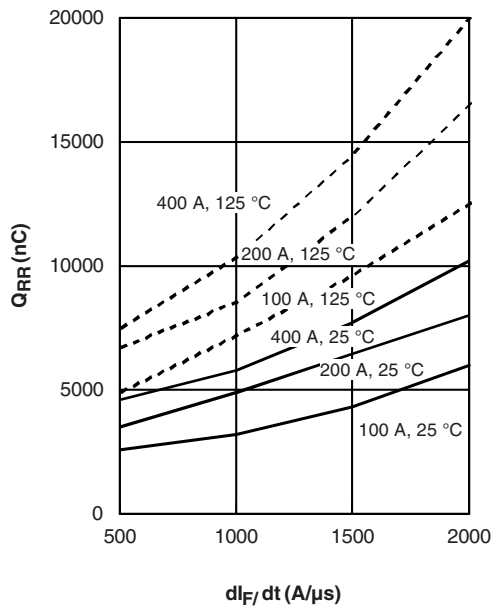

Fig. 12 - Typical Stored Charge vs. di_F/dt

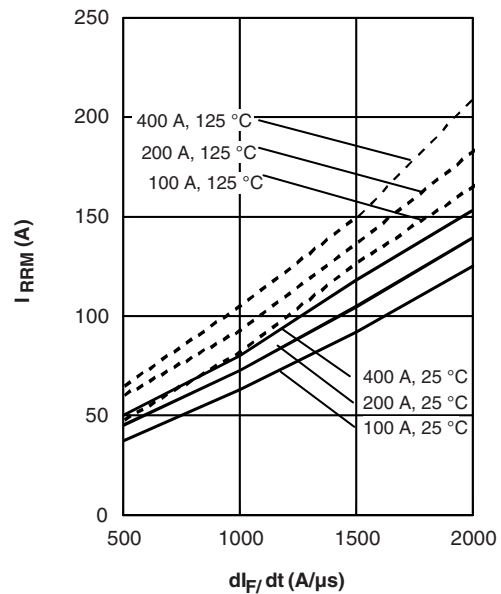

Fig. 14 - Typical Reverse Recovery vs. di_F/dt

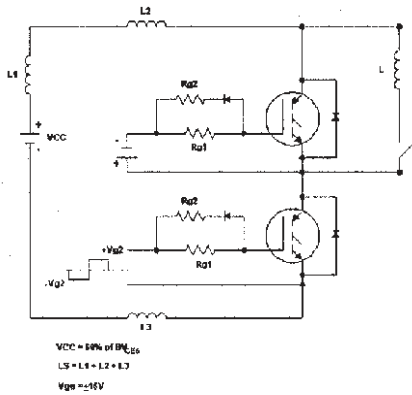

Fig. 15a - Test Circuit for Measurement of I_{LM} , E_{on} , $E_{off}(\text{diode})$, t_{rr} , Q_{rr} , I_{rr} , $t_{d(on)}$, t_r , $t_{d(off)}$, t_f

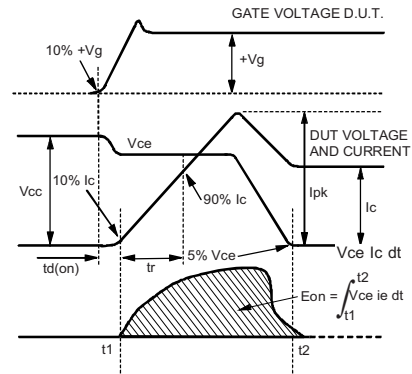

Fig. 15c - Test Waveforms for Circuit of Fig. 18a, Defining E_{on} , $t_{d(on)}$, t_r

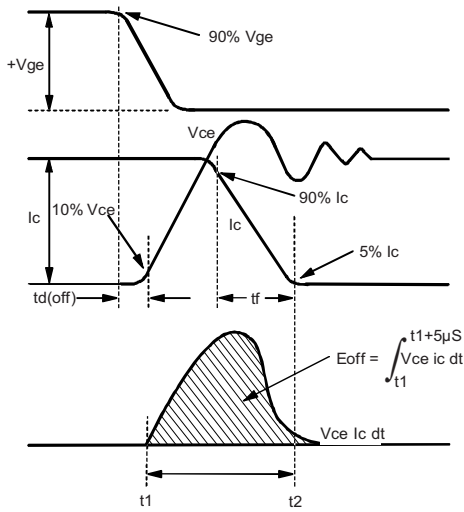

Fig. 15b - Test Waveforms for Circuit of Fig. 18a, Defining E_{off} , $t_{d(off)}$, t_f

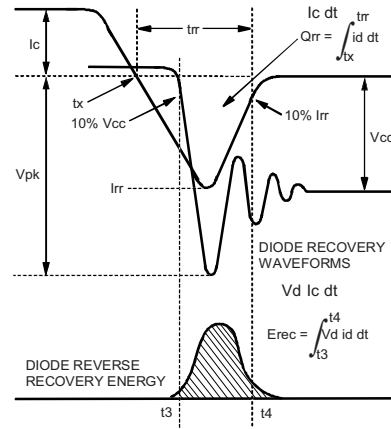

Fig. 15d - Test Waveforms for Circuit of Fig. 18a, Defining E_{rec} , t_{rr} , Q_{rr} , I_{rr}

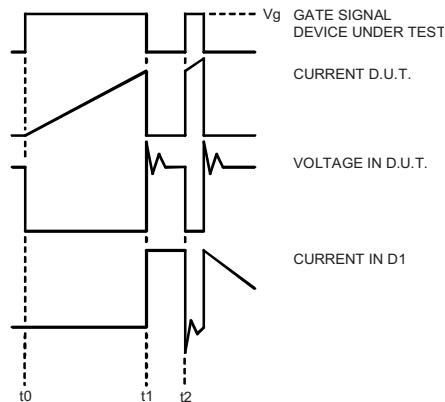

Fig. 15e - Macro Waveforms for Figure 18a's Test Circuit

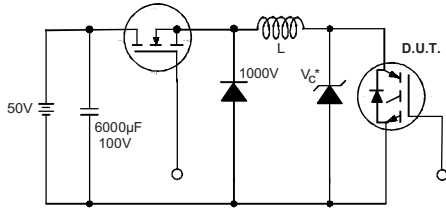

Fig. 16 - Clamped Inductive Load Test Circuit

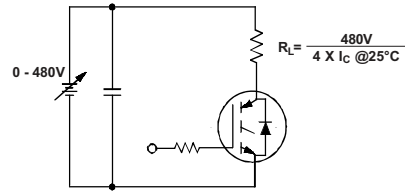

Fig. 17 - Pulsed Collector Current Test Circuit

ORDERING INFORMATION TABLE

Device code	GA	200	T	S	60	U	PbF
	①	②	③	④	⑤	⑥	⑦

- 1** - Essential part number IGBT modules
- 2** - Current rating (200 = 200 A)
- 3** - Circuit configuration (T = Half bridge)
- 4** - INT-A-PAK
- 5** - Voltage code (60 = 600 V)
- 6** - Speed/type (U = Ultrafast IGBT)
- 7** - PbF = Lead (Pb)-free

CIRCUIT CONFIGURATION

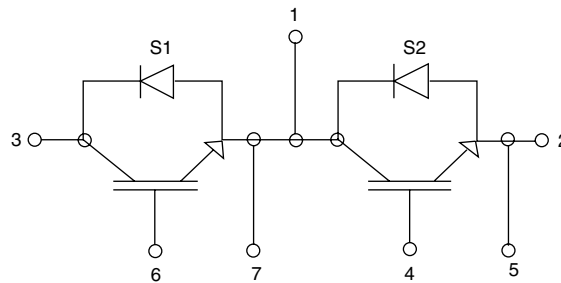

LINKS TO RELATED DOCUMENTS	
Dimensions	www.vishay.com/doc?95173

Disclaimer

All product specifications and data are subject to change without notice.

Vishay Intertechnology, Inc., its affiliates, agents, and employees, and all persons acting on its or their behalf (collectively, "Vishay"), disclaim any and all liability for any errors, inaccuracies or incompleteness contained herein or in any other disclosure relating to any product.

Vishay disclaims any and all liability arising out of the use or application of any product described herein or of any information provided herein to the maximum extent permitted by law. The product specifications do not expand or otherwise modify Vishay's terms and conditions of purchase, including but not limited to the warranty expressed therein, which apply to these products.

No license, express or implied, by estoppel or otherwise, to any intellectual property rights is granted by this document or by any conduct of Vishay.

The products shown herein are not designed for use in medical, life-saving, or life-sustaining applications unless otherwise expressly indicated. Customers using or selling Vishay products not expressly indicated for use in such applications do so entirely at their own risk and agree to fully indemnify Vishay for any damages arising or resulting from such use or sale. Please contact authorized Vishay personnel to obtain written terms and conditions regarding products designed for such applications.

Product names and markings noted herein may be trademarks of their respective owners.