



M.S.KENNEDY CORP.

5A EMI FILTER

BFL2805

4707 Dey Road Liverpool, N.Y. 13088

(315) 701-6751

FEATURES:

- Replaces APEX FDB461
- All Ceramic Capacitors
- Surface Mount Magnetics
- -55°C to +125°C Operation
- 60dB Minimum Differential Mode Rejection at 500KHz
- 5.5 Amps Throughput Current
- Meets MIL-STD-461C CE03 Standards For BBF2800 Series DC to DC Converters
- MIL-STD-704 (A Through E) Power Bus Compatibility

MIL-PRF-38534 CERTIFIED

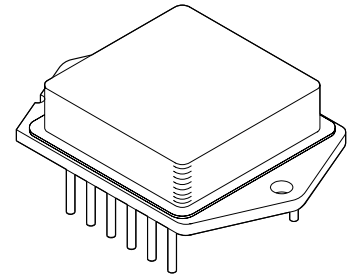

DESCRIPTION:

The BFL2805 is a high reliability EMI filter for use with BBF2800 series of DC-DC converters. This filter has been designed to reduce the input line reflected ripple current to within the limit of MIL-STD-461C, CE03.

The BFL2805 hybrid EMI filter utilizes all ceramic capacitors, surface mount magnetics and ultrasonically bonded aluminum wires to provide reliable operation at all operating temperatures while surviving very high G forces. The stand-alone filter's internal components are all passive devices and selected to operate from input voltages up to and including the peak transient voltage. The filter therefore does not require or utilize transient suppression circuitry and is compatible with the transient specification of a MIL-STD-704 type power bus. When connected to an output device, the output device must be able to operate from compatible voltages. The filter will attenuate spikes, but the duration and magnitude of the spike must be within the operating range of the filter.

The 12-pin high power dip package allows connection to a heatsink, is hermetically sealed and is isolated from the internal circuits. Heat sinking is recommended for full power operation at elevated ambient temperatures.

EQUIVALENT SCHEMATIC

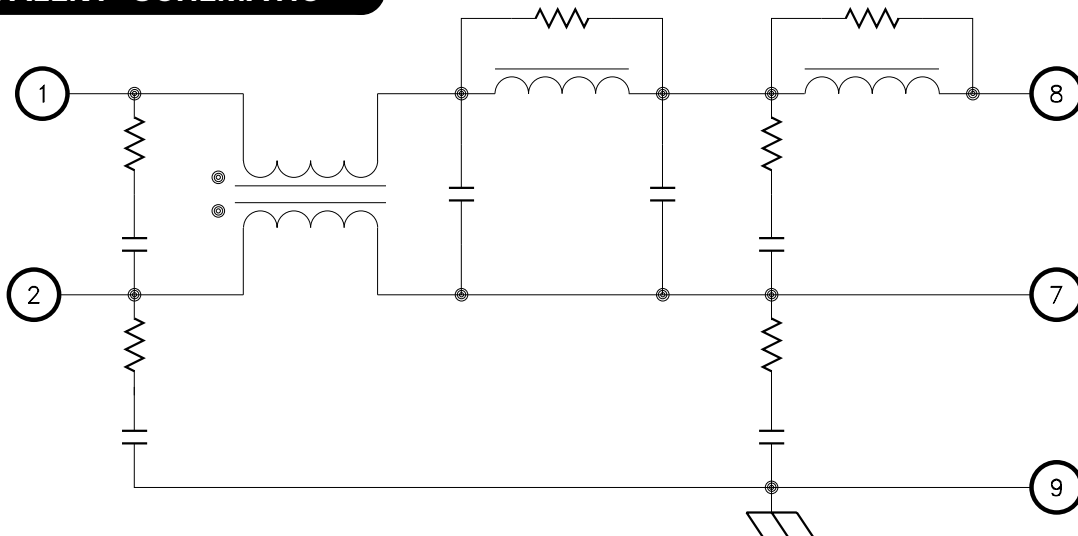

TYPICAL APPLICATIONS

- Airborne Power Systems
- Aerospace Power Systems
- Vehicle Electrical Systems
- Ground Equipment and Test Equipment

PIN-OUT INFORMATION

1 +VIN	12 NC
2 INPUT COMMON	11 NC
3 NC	10 NC
4 NC	9 CASE GROUND
5 NC	8 +VOUT
6 NC	7 OUTPUT COMMON

ABSOLUTE MAXIMUM RATINGS

⑥

Input Voltage Range 0-50VDC
 Input Voltage Transient 80V @ 50mS
 Voltage (any pin to case pin 9) 500V
 Storage Temperature Range . . . -65°C to +150°C
 Lead Temperature 300°C
 (10 Seconds Soldering)

Case Operating Temperature Range
 BFL2805H/E -55°C to +125°C
 BFL2805 -40°C to +85°C

ELECTRICAL SPECIFICATIONS

Parameter	Test Conditions	Subgroups	BFL2805H/E			BFL2805			Units
			Min.	Typ.	Max.	Min.	Typ.	Max.	
Input Voltage ①	Steady State	1,2,3	0	28	50	0	28	50	V
	Transient 50μsec. MAX	1	-	-	80	-	-	80	V
Input Current ①	DC	1	-	-	5.5	-	-	5.5	A
Output Voltage ②	Steady State	-	-	$V_{OUT} = V_{IN} - I_{in}(R_{DC})$	-	-	$V_{OUT} = V_{IN} - I_{in}(R_{DC})$	-	Vdc
Output Current ①	Ripple	1	-	-	0.3	-	-	0.3	A rms
	Steady State	1	-	-	5.5	-	-	5.5	A
DC Resistance (RDC)	Steady State	1	-	0.20	0.35	-	0.20	0.35	Ohms
Noise Reduction	f = 200KHz	4	40	50	-	40	50	-	dB
	f = 500 KHz	4	60	65	-	60	65	-	dB
	f = 1MHz	4	60	70	-	60	70	-	dB
	f = 5MHz	4	60	73	-	60	73	-	dB
Capacitance ①	Any Pin to Case	7	-	-	4.7	-	-	4.7	μF
Isolation	Any Pin to Case	7	100	-	-	100	-	-	MOhm

NOTES:

- ① This parameter is guaranteed by design but need not be tested.
- ② Typical parameters are representative of actual device performance but are for reference only.
- ③ Industrial grade and "E" suffix devices shall be tested to subgroup 1,4 and 7 unless otherwise specified.
- ④ Military grade devices ('H' suffix) shall be 100% tested to subgroups 1,2,3,4 and 7.
- ⑤ Subgroup 1,4,7 TA = TC = +25°C
 Subgroup 2 TA = TC = +125°C
 Subgroup 3 TA = TC = -55°C
- ⑥ Continuous operation at or above absolute maximum ratings may adversely effect the device performanc and/or life cycle.

TYPICAL PERFORMANCE CURVES

[查询"MSKBFL2805"供应商](#)

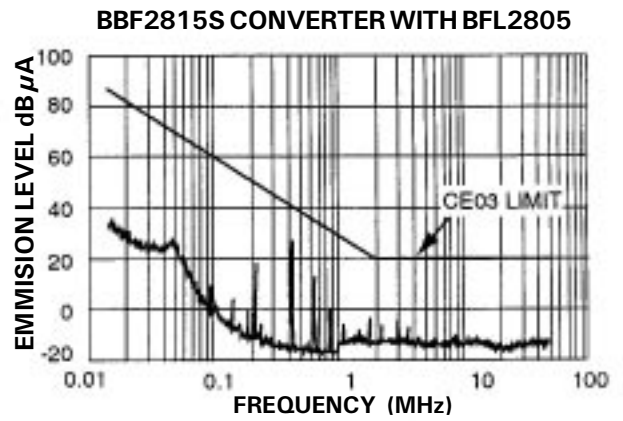
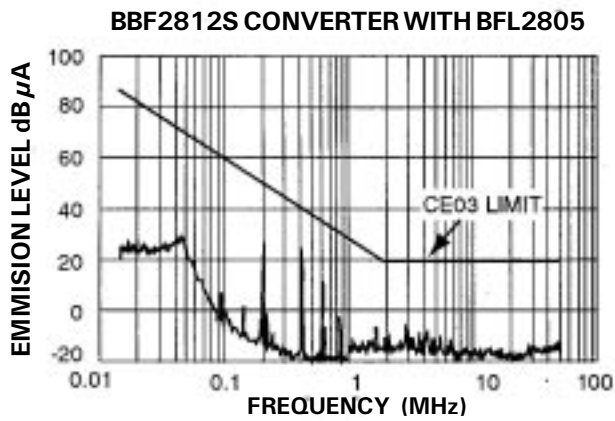
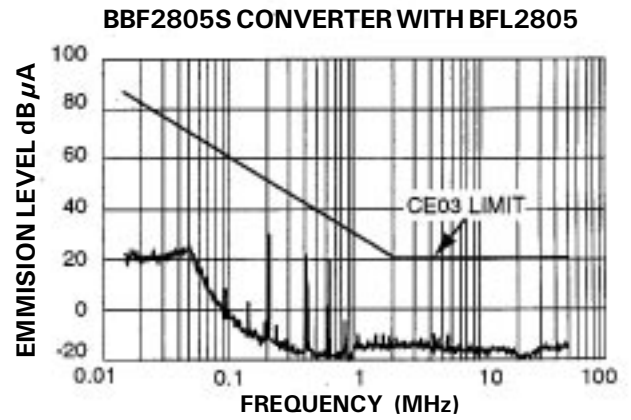
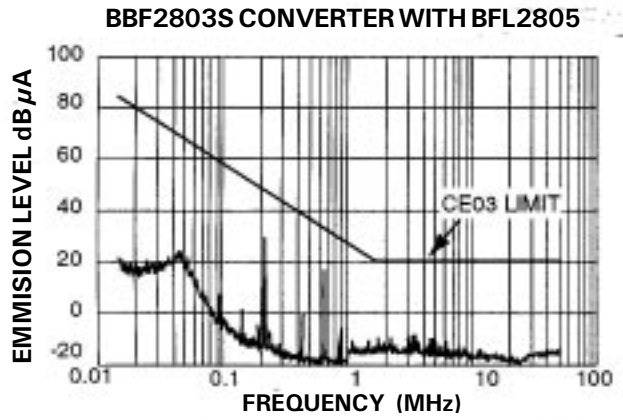

TYPICAL APPLICATION

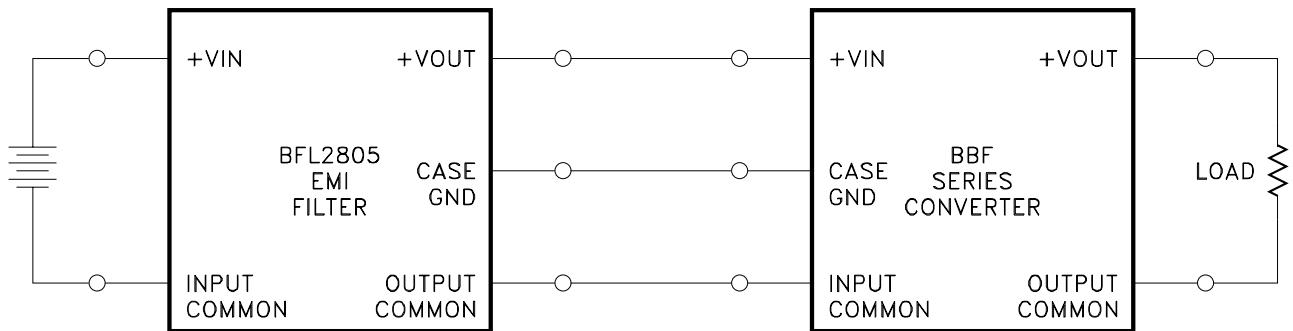

MECHANICAL SPECIFICATIONS

[查询"MSKBFL2805"供应商](#)

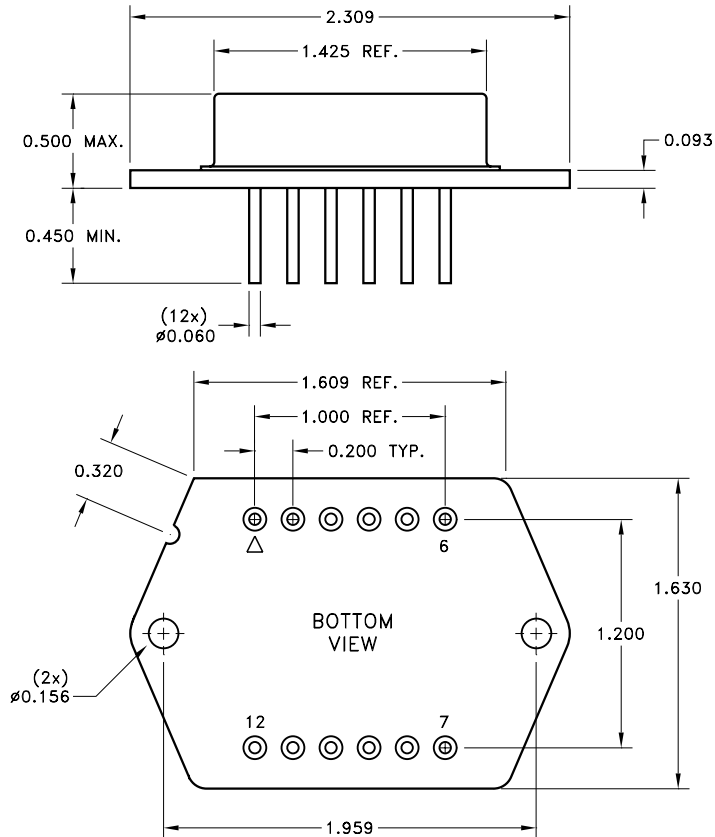

WEIGHT = 67 GRAMS TYPICAL
ESD Triangle Indicates Pin 1.

NOTE: ALL DIMENSIONS ARE $\pm .010$ INCHES UNLESS OTHERWISE LABELED.

ORDERING INFORMATION

BFL2805H

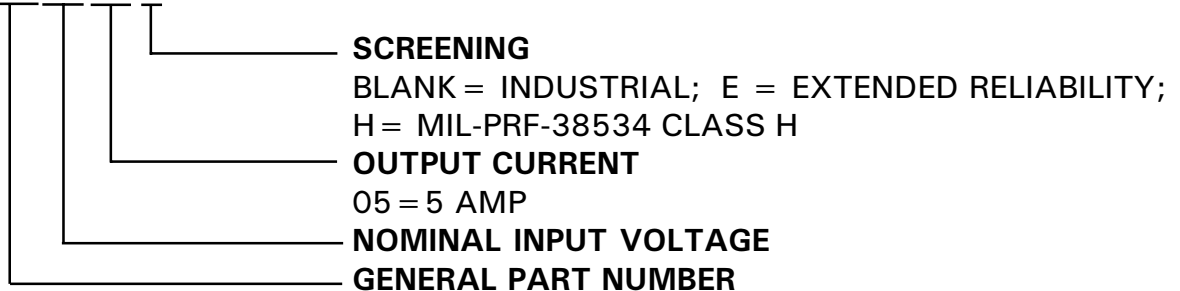

The above example is a Military grade 5 Amp EMI filter.

M.S. Kennedy Corp.
4707 Dey Road, Liverpool, New York 13088
Phone (315) 701-6751
FAX (315) 701-6752
www.mskennedy.com

The information contained herein is believed to be accurate at the time of printing. MSK reserves the right to make changes to its products or specifications without notice, however, and assumes no liability for the use of its products. Please visit our website for the most recent revision of this datasheet.