

## Intelligent Power Module ( R-Series )

### Maximum Ratings and Characteristics

#### Absolute Maximum Ratings ( T<sub>c</sub>=25°C )

Items	Symbols	Ratings		Units
		Min.	Max.	
DC Bus Voltage	V <sub>DC</sub>	0	450	V
DC Bus Voltage (surge)	V <sub>DC(Surge)</sub>	0	500	
DC Bus Voltage (short operating)	V <sub>SC</sub>	200	400	
Collector-Emitter Voltage	V <sub>CES</sub>	0	600	A
Inverter	I <sub>C</sub>		100	
Collector	I <sub>CP</sub>		200	
Current	-I <sub>C</sub>		100	W
Collector Power Dissipation (One Transistor)	P <sub>C</sub>		400	
Voltage of Power Supply for Driver	V <sub>CC</sub>	0	20	V
Input Signal Voltage	V <sub>IN</sub>	0	V <sub>Z</sub>	
Input Signal Current	I <sub>IN</sub>		1	mA
Alarm Signal Voltage	V <sub>ALM</sub>	0	V <sub>CC</sub>	
Alarm Signal Current	I <sub>ALM</sub>		15	mA
Junction Temperature	T <sub>J</sub>		150	
Operating Temperature	T <sub>OP</sub>	-20	100	°C
Storage Temperature	T <sub>stg</sub>	-40	125	
Isolation Voltage	V <sub>iso</sub>	A.C. 1min.	2500	V
Screw Torque	Mounting *1		3.5	
	Terminals *1		3.5	

Note: \*1: Recommendable Value: 2.5 - 3.0 Nm (M5)

### Outline Drawing

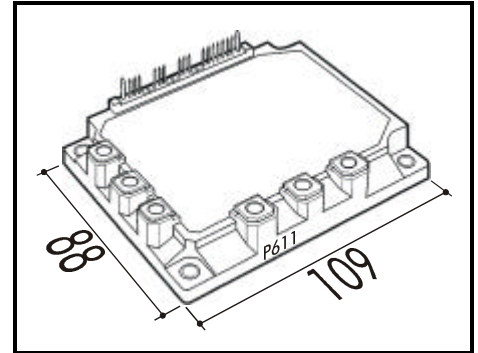

#### Electrical Characteristics of Power Circuit ( at T<sub>J</sub>=25°C, V<sub>CC</sub>=15V )

Items		Symbols	Conditions	Min.	Typ.	Max.	Units
INV	Collector Current At Off Signal Input	I <sub>CES</sub>	V <sub>CE</sub> =600V, Input Terminal Open			1.0	mA
	Collector-Emitter Saturation Voltage	V <sub>CE(Sat)</sub>	I <sub>C</sub> =100A			2.8	
	Forward Voltage of FWD	V <sub>F</sub>	-I <sub>C</sub> =100A			3.0	V

#### Electrical Characteristics of Control Circuit ( at T<sub>J</sub>=25°C, V<sub>CC</sub>=15V )

Items		Symbols	Conditions	Min.	Typ.	Max.	Units
Current of P-Line Side Driver (One Unit)		I <sub>CCP</sub>	f <sub>SW</sub> =0~15kHz, T <sub>C</sub> =-20~100°C	3		18	mA
Current of N-Line Side Driver (Three Units)		I <sub>CCN</sub>	f <sub>SW</sub> =0~15kHz, T <sub>C</sub> =-20~100°C	10		65	
Input Signal Threshold Voltage		V <sub>IN(th)</sub>	On	1.00	1.35	1.70	V
			Off	1.25	1.60	1.95	
Input Zener Voltage		V <sub>Z</sub>	R <sub>IN</sub> =20kΩ		8.0		°C
Over Heating Protection Temperature Level		T <sub>COH</sub>	V <sub>DC</sub> =0V, I <sub>C</sub> =0A, Case Temp.	110		125	
Hysteresis		T <sub>CH</sub>			20		°C
IGBT Chips Over Heating Protec. Temp. Level		T <sub>JOH</sub>	Surface of IGBT Chip	150			
Hysteresis		T <sub>IH</sub>			20		A
Inverter Collector Current Protection Level		I <sub>OC</sub>	T <sub>J</sub> =125°C	150			
Over Current Detecting Time		t <sub>DOC</sub>	T <sub>J</sub> =25°C		10		μs
Alarm Signal Hold Time		t <sub>ALM</sub>		1.5	2		
Limiting Resistor for Alarm		R <sub>ALM</sub>		1425	1500	1575	Ω
Under Voltage Protection Level		V <sub>UV</sub>		11.0		12.5	
Hysteresis		V <sub>H</sub>		0.2			V

#### Dynamic Characteristics ( at T<sub>C</sub>=T<sub>J</sub>=125°C, V<sub>CC</sub>=15V )

Items		Symbols	Conditions	Min.	Typ.	Max.	Units
Switching Time		t <sub>ON</sub>	I <sub>C</sub> =100A, V <sub>DC</sub> =300V	0.3			μs
		t <sub>OFF</sub>				3.6	
		t <sub>RR</sub>	I <sub>F</sub> =100A, V <sub>DC</sub> =300V			0.4	

#### Thermal Characteristics

Items		Symbols	Conditions	Min.	Typ.	Max.	Units
Thermal Resistance		R <sub>th(i-c)</sub>	Inverter IGBT			0.31	°C/W
		R <sub>th(i-c)</sub>	Diode			0.70	
		R <sub>th(c-f)</sub>	With Thermal Compound		0.05		

## ■ Equivalent Circuit

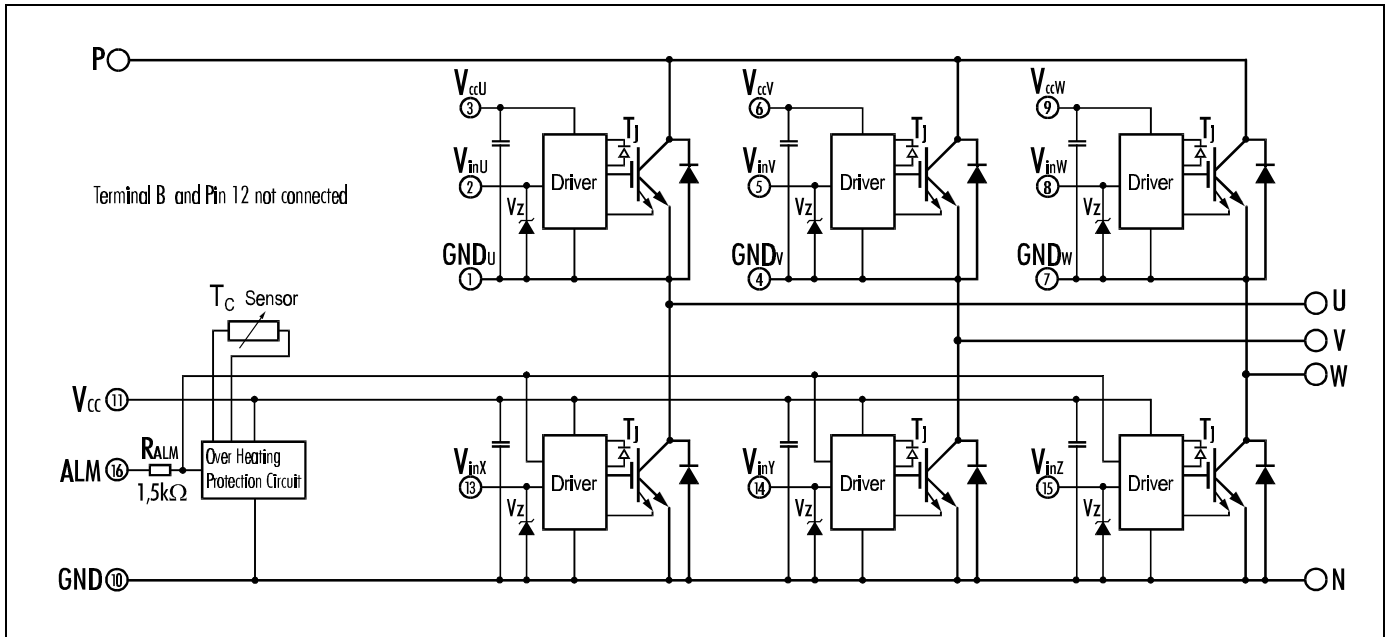

Drivers include following functions

- Short circuit protection circuit
- Amplifier for driver
- Undervoltage protection circuit
- Overcurrent protection circuit
- IGBT Chip overheating protection

## Control Circuit

Power Supply Current vs. Switching Frequency

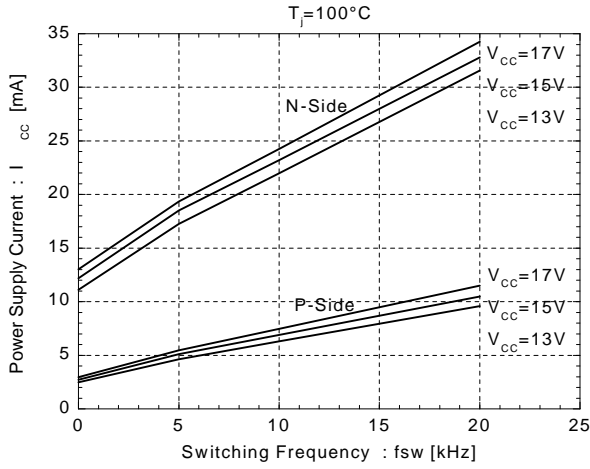

Input Signal Threshold Voltage vs. Power Supply Voltage

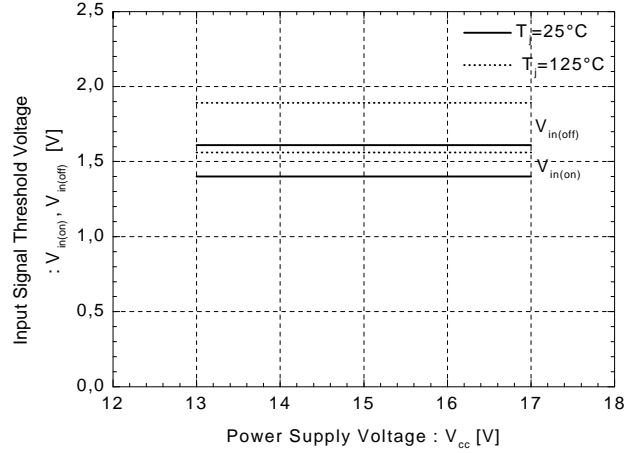

Under Voltage vs. Junction Temperature

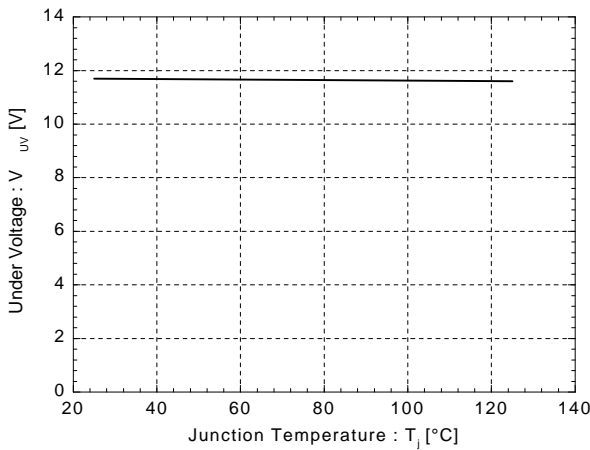

Under Voltage Hysteresis vs. Junction Temperature

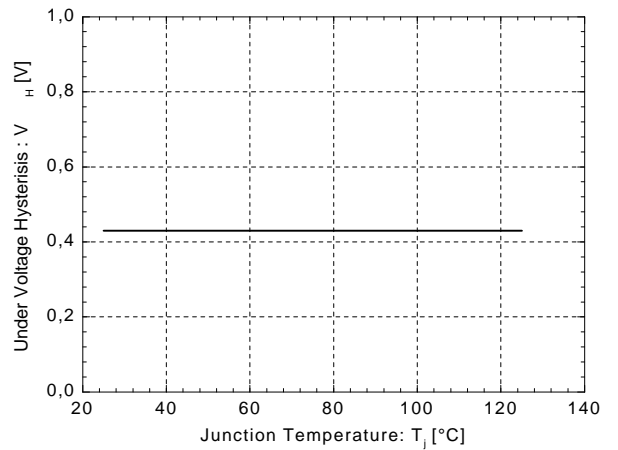

Alarm Hold Time vs. Power Supply Voltage

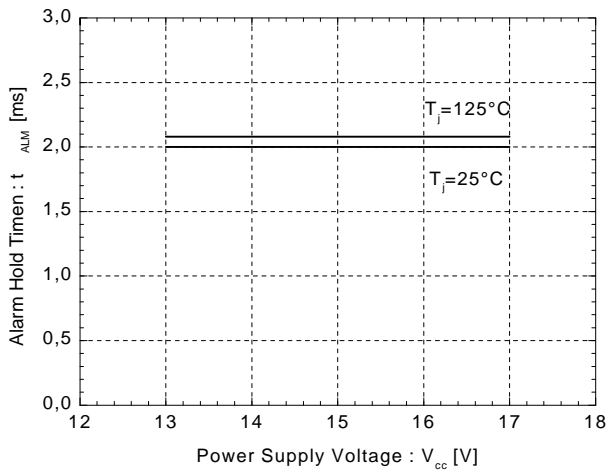

Over Heating Characteristics

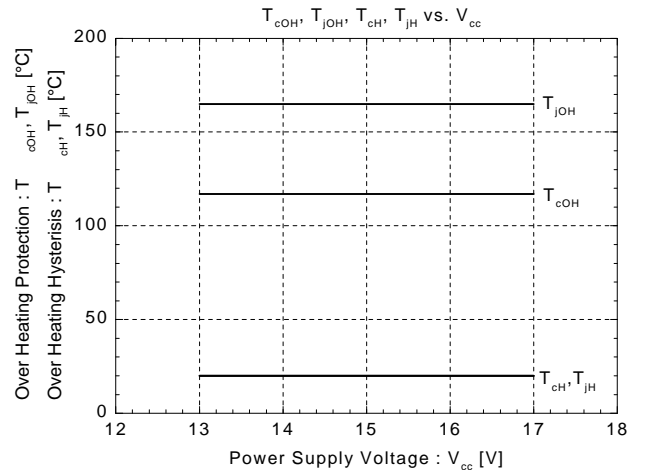

## ■ Inverter

Collector Current vs. Collector-Emitter Voltage

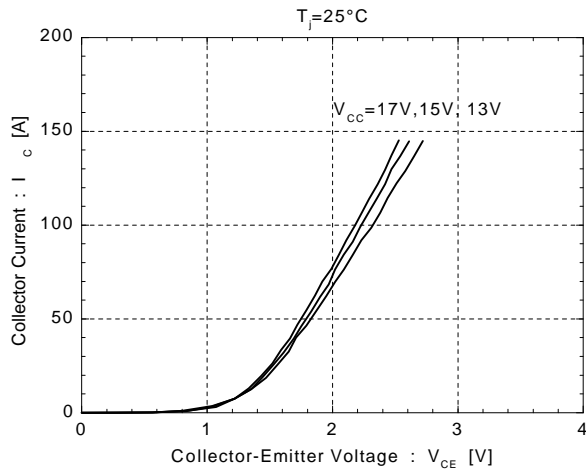

Collector Current vs. Collector-Emitter Voltage

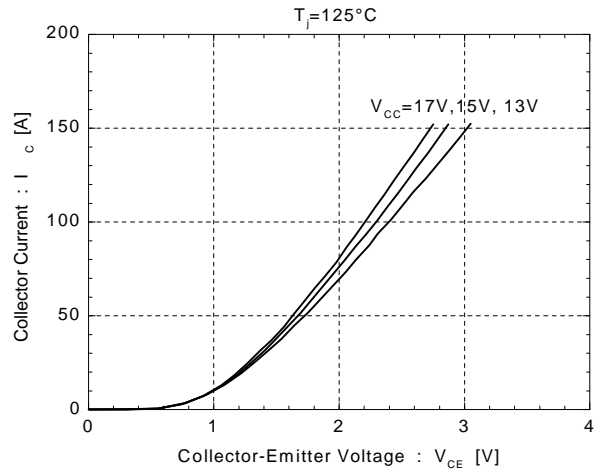

Switching Time vs. Collector Current

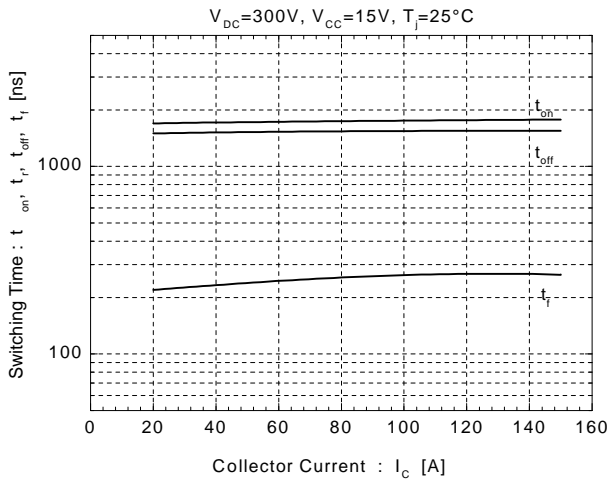

Switching Time vs. Collector Current

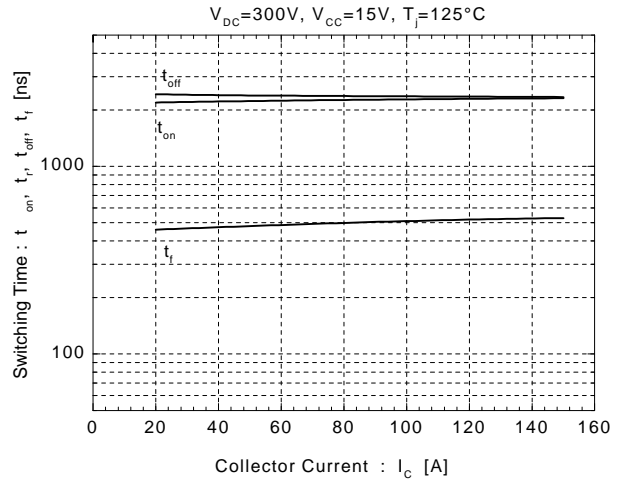

Forward Voltage vs. Forward Current

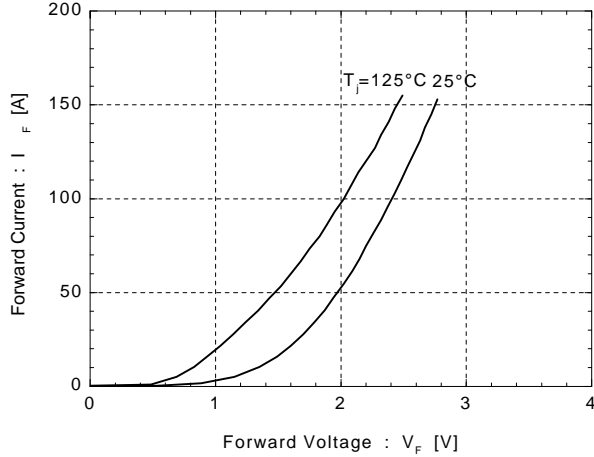

Reverse Recovery Characteristics

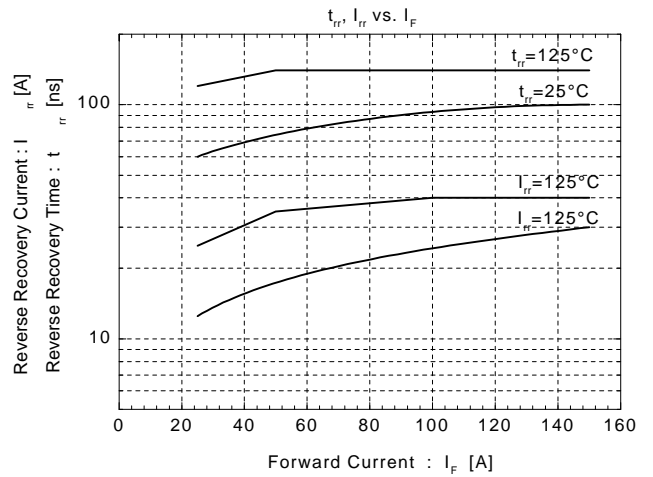

## ■ Inverter

Transient Thermal Resistance

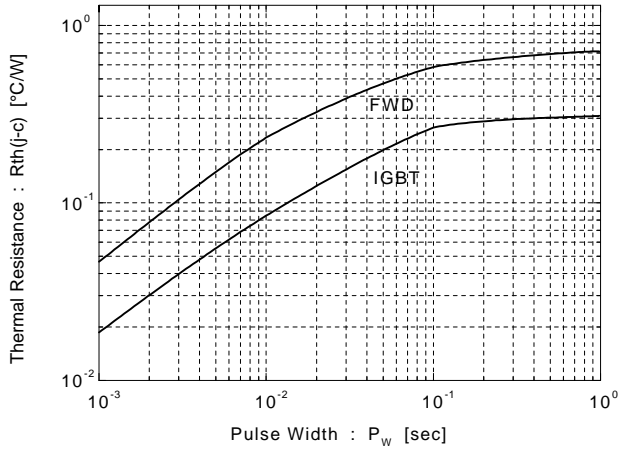

Reverse Biased Safe Operating Area

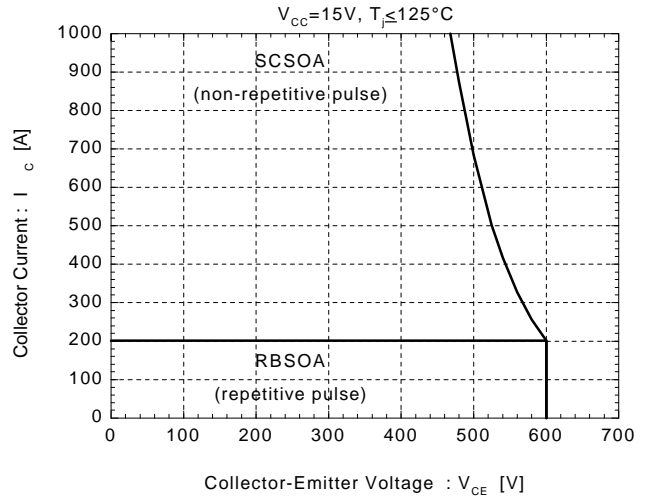

Power Derating For IGBT  
(per device)

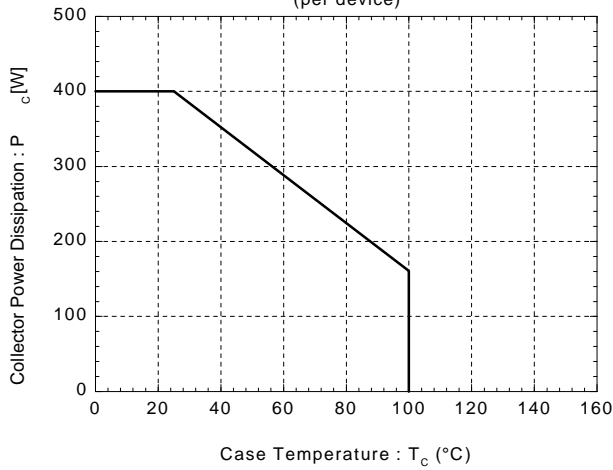

Power Derating For FWD  
(per device)

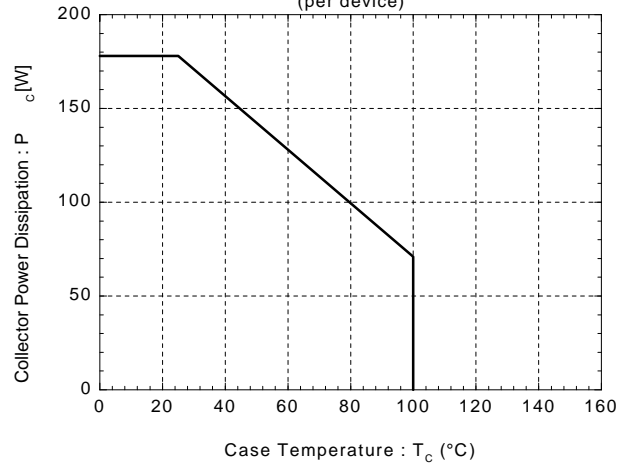

Switching Loss vs. Collector Current

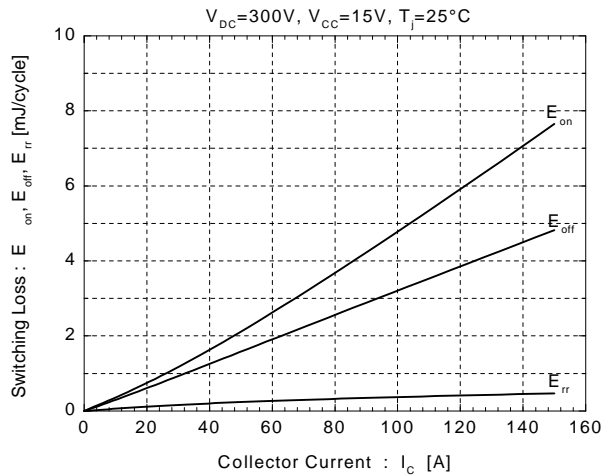

Switching Loss vs. Collector Current

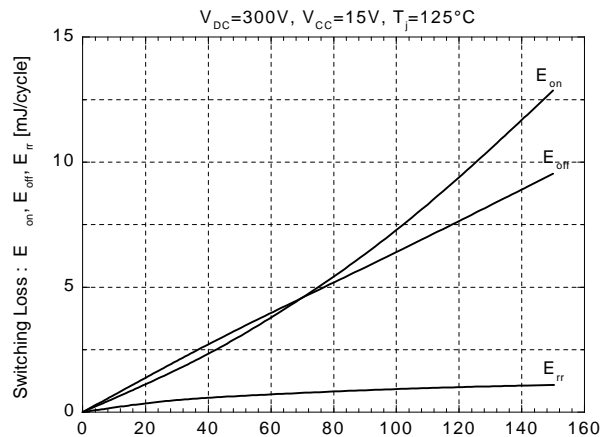

## ■ Inverter

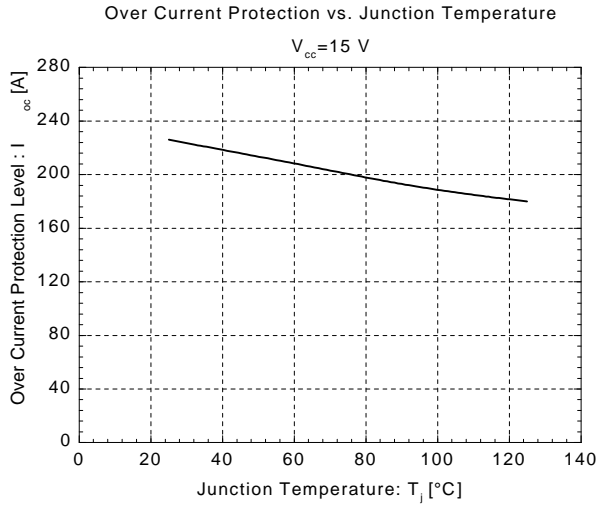

## ■ Outline Drawing

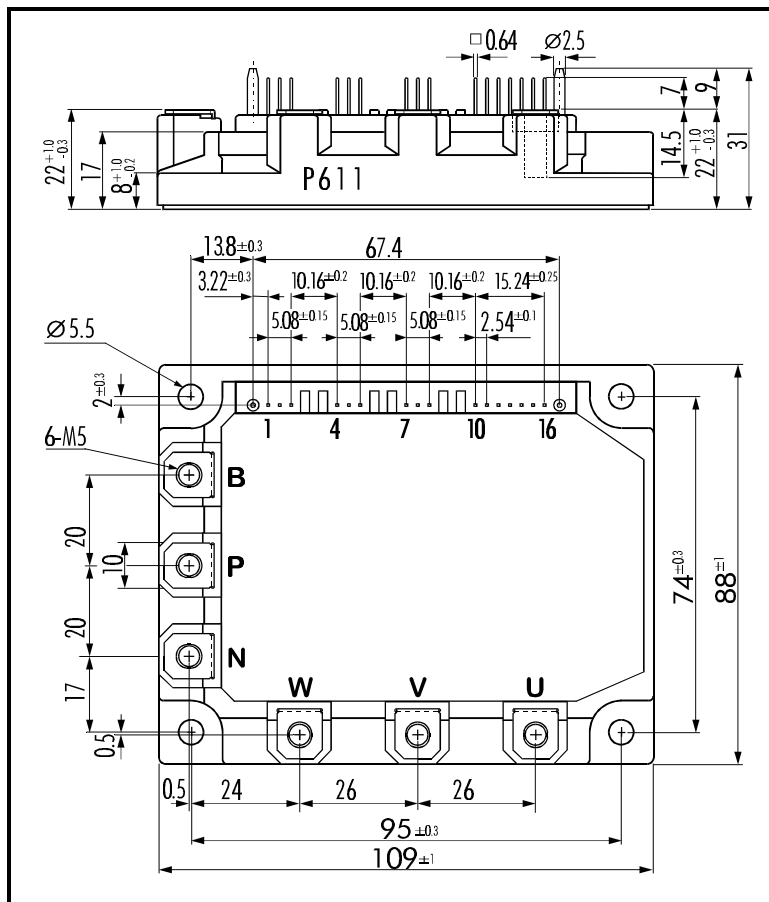

**Weight: 440g**