



3014A

T-74-05-01

CMOS LSI

Level Meter with Peak Hold Function

©724C

Applications

- . Peak hold level meter of tape deck.
- . Peak hold level meter of power amplifier.
- . General-purpose level meter.

Features

- . C MOS LSI for 2-channel (12 points + 12 points) peak hold level meter.
- . Capable of driving a static lighting type fluorescent display tube of 23V or less.
- . Three types of applications are available as follows :
 - a) 2-channel peak hold level meter.
 - b) 2-channel level meter.
 - c) Signal meter and tuning meter.

Functions

- . Peak hold function.
 - . 1-point peak hold.
 - . Peak hold comes in 2 types as follows :
 - a) Automatic reset
Peak hold is reset automatically after lapse of a specified period of time (settable).
 - b) Manual reset
Peak hold is reset with a reset switch.
- . Muting function
Display is unlighted for a certain period of time at the time of application of power.
- . Monaural function
Display unbalance between left and right channels is eliminated at the time of application of monaural input signal.
- . Comparator level
 - . Linear scale

Case Outline 3014A-D42IC
(unit:mm)

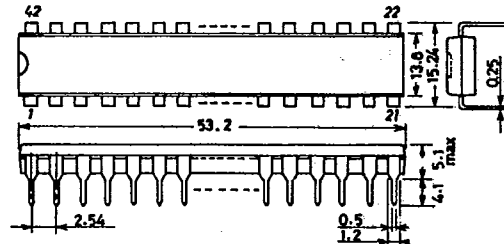

SANYO: DIP42

Pin Assignment

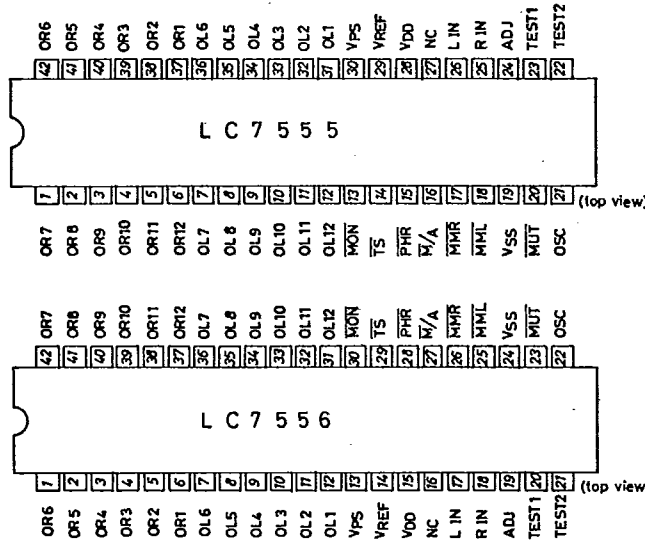

Sample Application Circuit

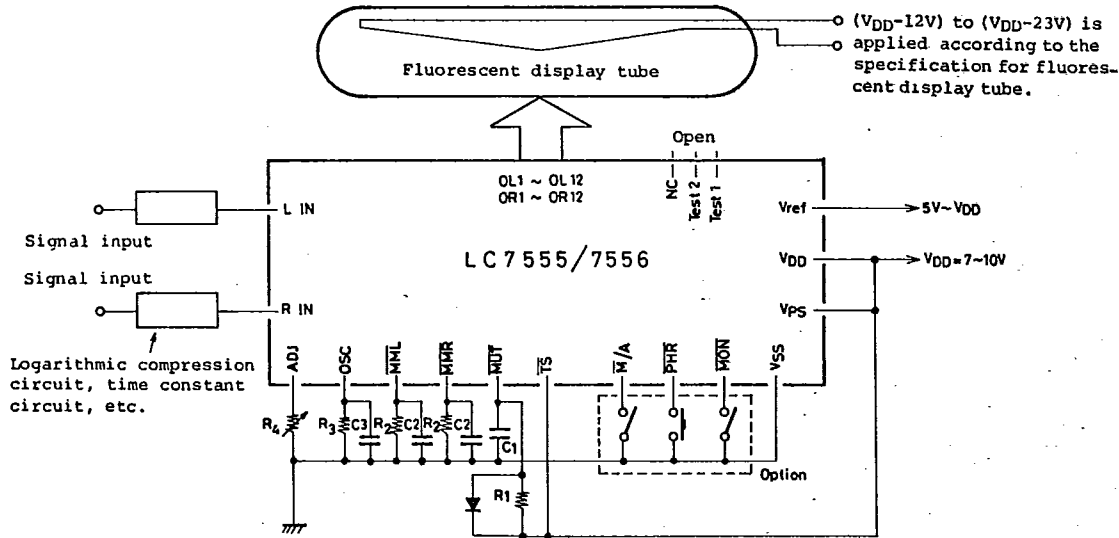

Reference values of constants

- $R_1=220\text{kohms}, C_1=0.68\mu\text{F}$ ----- Values for V_{DD} rise time of less than 50msec. Refer to Fig.13.
- $R_2=470\text{kohms}, C_2=3.3\mu\text{F}$ ----- Values for peak hold time of approximately 1 sec. Refer to Fig.11.
- $R_3=56\text{kohms}, C_3=1000\text{pF}$ ----- Values for oscillation frequency of approximately 26.7kHz. Refer to Fig.12. Variations in frequency with temperature are reduced by using carbon film resistor and polyester film capacitor.
- $R_4=20\text{kohms}$ ----- Values for displaying all points at $V_{\text{ref}}=8\text{V}, V_{\text{IN}}=4\text{V}$. Refer to Figs.9, 10.

Sample Logarithmic Compression Circuit, Time Constant Circuit

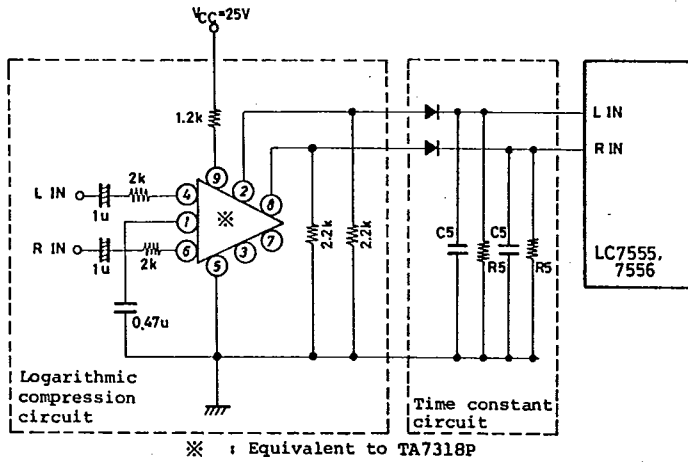

Reference values of constants

($R_5=220nF$) Values for fixing recovery time.
 $C_5=2Mohms$

For the logarithmic compression circuit and time constant circuit in the sample application circuit, the relation between the input voltage of logarithmic compression circuit and the output voltage of time constant circuit is as shown right. If the full scale input voltage is taken as 4V and input level 145mV is taken as 0dB, the relation between the number of points lighted and the input level becomes as shown below.

Characteristic of Logarithmic Compression Circuit, Time Constant Circuit

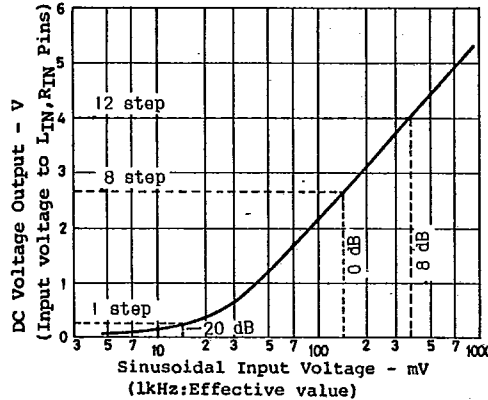

Table 1. Fluorescent Display Tube and Input Level

unit:dB

Number of points lighted	1	2	3	4	5	6	7	8	9	10	11	12
Input level (Approximate value)	-20	-14	-10	-8	-6	-4	-2	0	2	4	6	8

Note) If V_{ref} is 8V, it is seen from Figs.9, 10 that ADJ resistance 20kohms causes full scale input voltage 4V.

Equivalent Circuit Block Diagram

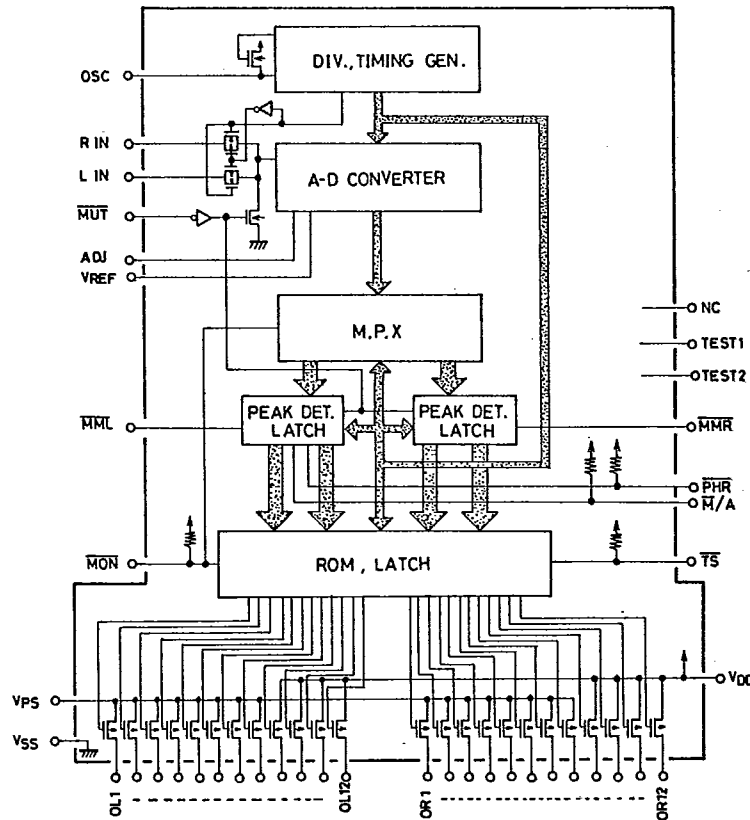

Pin Description

1. OL₁ to OL₁₂, OR₁ to OR₁₂
 - . Output pins of P channel, open drain type for fluorescent display tube drive.
 - . Output withstand voltage (V_{DD}-23V) max.
2. L IN, R IN
 - . Input pins for display levels of left/right channels.
 - . The comparator level is of linear scale and if the full scale input voltage (input voltage at which 12 points are all lighted) is taken as 3.6V, the number of points lighted will be increased in such a way as 1 point, 2 points, ----- each time the voltage is increased by 300mV starting at 0V.
 - . The attack/release (recovery) circuit to fix the response speed is attached externally. To provide logarithmic compression display, the log amplifier is attached externally.
3. ADJ
 - . Input pin for full scale adjustment.
 - . The input voltage (full scale input voltage) at which 12 points are all lighted can be adjusted by adjusting external resistor R₄.
 - . The full scale input voltage depends on the voltage applied to V_{ref}, the internal resistance of LSI, and R₄. (Refer to Figs. 9, 10.)
4. M/A
 - . Input pin for controlling changeover of manual/automatic reset of the peak hold point.
 - . Automatic reset mode is available when the V_{DD} level is applied or the input pins are open; manual reset mode is available when the V_{SS} level is applied.
5. PHR
 - . Pin for applying the signal to reset the peak hold point at the time of manual reset mode.

Continued on next page.

查询"LC7555"供应商

LC7555,7556

T-74-05-01

Continued from preceding page.

- . If the V_{SS} level is applied, the peak hold point will be reset.
 - . If V_{SS} remains applied to the PHR pin at the time of manual reset mode, the ordinary level meter without peak hold function will result.
6. MML, MMR
- . The peak hold time at the time of automatic reset mode is as shown in Fig. 11.

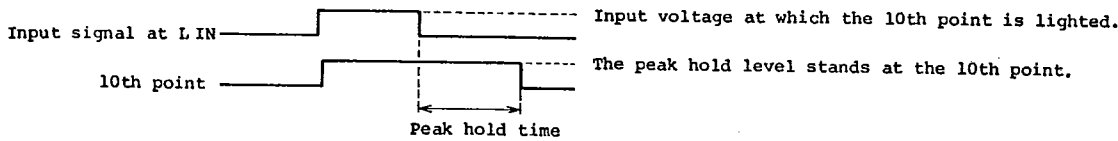

7. MON
- . Control input pin for monaural application only.
 - . The L IN signal is displayed on OL1 to OL2 and OR1 to OR12. Thus, unbalance between left and right channels is eliminated.
8. MUT
- . Pin for externally attaching the time constant circuit to reset the peak hold function for a specified period of time and also to set the L IN/R IN inputs at the V_{SS} level at the time of application of power.
9. TS
- . Pin for controlling changeover of the peak hold meter function into the tuning/signal meter.
 - . Operation as the peak hold level meter is available when the V_{DD} level is applied to TS or the input pins are open; operation as the tuning meter and signal meter is available when the V_{SS} level is applied.

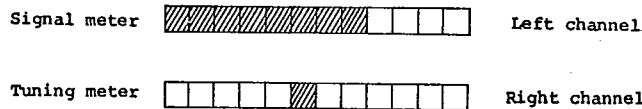

10. OSC
- . Pin for externally attaching C, R to generate control clock inside the LSI.
 - . When the oscillation frequency is at 26.6kHz, the L IN/R IN input signals are alternately sampling-processed once in approximately 2.4msec.

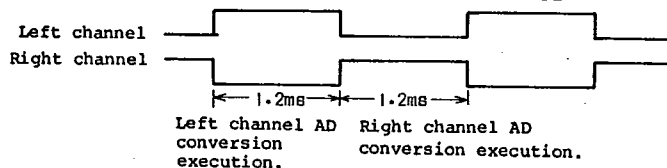

- . The relation between the oscillation frequency and the external constant is shown in Fig.12.

11. Vref
- . Pin for connecting the reference voltage for AD conversion.
12. VPS

- . Common source pin for drivers of OL1 to OL8, OR1 to OR8.
- . The fluorescent display tube shown below is taken as an example. If 9V, 5V, and -10V are applied to V_{DD}, V_{PS}, and the fluorescent display tube filament respectively, -15V and -19V will be applied to the green segments and orange segments respectively.

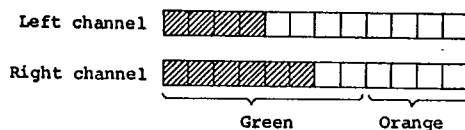

查询"LC7555"供应商

LC7555,7556

T-74-05-01

13. V_{DD}, V_{SS}
 . Pins for applying supply voltages.

Summary of Control Pin Operations

Operation mode	\overline{TS}	\overline{MON}	$\overline{M/A}$	\overline{PHR}
Stereo peak hold meter				
. Automatic reset of peak hold point.	1	1	1	x
. Manual reset of peak hold point.	1	1	0	(1)
Monaural peak hold meter				
. Automatic reset of peak hold point.	1	0	1	x
. Manual reset of peak hold point.	1	0	0	(1)
Stereo level meter	1	1	0	0
Monaural level meter	1	0	0	0
Tuning meter & signal meter	0	x	x	x

Note : 1 : V_{DD} level applied or open.
 0 : V_{SS} level applied or open.
 x : Either V_{DD} level or V_{SS} level.
 (1): Normally V_{DD} level applied or open. V_{SS} applied only when resetting.

Absolute Maximum Ratings at T_a=25°C, V_{SS}=0V

Parameter	Symbol	Condition	Value	Unit
Maximum Supply Voltage	V _{DD}		-0.3 to +11	V
Reference Voltage	V _{ref}		-0.3 to V _{DD} +0.3	V
Input Voltage	V _{IN}	Input/output pins OSC, MML, MMR, RIN, LIN: output off	-0.3 to V _{DD} +0.3	V
Output Voltage	V _{OUT}	OL1 to OL8, OR1 to OR8 : output off	V _{DD} -23 to V _{PS} +0.3	V
		OL9 to OL12, OR9 to OR12: output off	V _{DD} -23 to V _{DD} +0.3	V
Allowable Power Dissipation	P _{dmax}	T _a ≤ 70°C	250	mW
Allowable Power Dissipation of Segments	P _{dseg}	OL1 to OL8, OR1 to OR8, I _O ≤ 1.5mA, V _{PS} =V _{DD} (I _O ≤ 0.8mA, V _{PS} =5V ≤ V _{DD})	7	mW
		OL9 to OL12, OR9 to OR12, I _O ≤ 1.5mA	7	mW
Operating Temperature	T _{opg}		-30 to +70	°C
Storage Temperature	T _{stg}		-40 to +125	°C

Allowable Operating Conditions at T_a=25°C, V_{SS}=0

Parameter	Symbol	Condition	min	typ	max	unit
Supply Voltage	V _{DD}		7		10	V
	V _{PS}		5		V _{DD}	V
Reference Voltage	V _{ref}		5		V _{DD}	V
"H"-Level Input Voltage	V _{IH} (1)	$\overline{M/A}, \overline{PHR}, \overline{TS}, \overline{MON}$	V _{DD} -1.1		V _{DD}	V
"L"-Level Input Voltage	V _{IL} (1)	$\overline{M/A}, \overline{PHR}, \overline{TS}, \overline{MON}$	0		1.1	V
"H"-Level Input Voltage	V _{IH} (2)	\overline{MUT}	0.7V _{DD}		V _{DD}	V
"L"-Level Input Voltage	V _{IL} (2)	\overline{MUT}	0		0.3V _{DD}	V
Input Voltage	V _{IN}	RIN, LIN; V _{IN} ≤ V _{ref} , V _{IN} ≤ V _{DD} -3V	0		5	V
Full Scale Input Voltage		RIN, LIN; V _{IN} ≤ V _{ref} , V _{IN} ≤ V _{DD} -3V	2.5		5	V

Electrical Characteristics at T_a=25°C

Parameter	Symbol	Condition	min	typ	max	unit
Input Current	I _{IN}	\overline{MUT} ; V _{IN} =V _{DD}			3.0	uA
		\overline{MUT} ; V _{IN} =V _{SS}	-3.0			uA
Input Floating Voltage	V _{IF}	$\overline{M/A}, \overline{PHR}, \overline{TS}, \overline{MON}$; input open	V _{DD} -0.9			V

Continued on next page.

查询"LC7555"供应商

LC7555,7556

T-74-05-01

Continued from preceding page.

			min	typ	max	unit
"L"-Level Input Current	$I_{IL}(1)$	$\overline{M/A}, \overline{PHR}, \overline{TS}, \overline{MON}; V_{IN}=V_{SS}$	-550		-25	μA
"H"-Level Output Voltage	$V_{OH}(1)$	OL1 to OL8, OR1 to OR8; V_{PS}	$V_{DD}-4.5$			V
		$=V_{DD}, I_O=1.5mA$				
		OL1 to OL8, OR1 to OR8; V_{PS}	$V_{PS}-6.0$			V
		$=5V \leq V_{DD}, I_O=0.8mA$				
	$V_{OH}(2)$	OL9 to OL12, OR9 to OR12;	$V_{DD}-4.5$			V
		$I_O=1.5mA$				
Output Off Leak Current	I_{OFF}	$\overline{MML}, \overline{MMR}, I_{I/O}=0.5mA$	$V_{DD}-0.9$			V
		OL1 to OL12, OR1 to OR12;	-3.0			μA
		$V_{PS}=V_{DD}, V_O=V_{DD}-21V$, output off				
Input/Output Off Leak Current	$I_{I/O}$	OSC, $\overline{MML}, \overline{MMR}$; output off				
		$V_{I/O}=V_{DD}$			3.0	μA
		$V_{I/O}=V_{SS}$	-3.0			μA
		LIN, RIN; $\overline{MUT}=V_{DD}$				
		$V_{I/O}=V_{DD}$			3.0	μA
		$V_{I/O}=V_{SS}$	-3.0			μA
"L"-Level Output Voltage	V_{OL}	LIN, RIN; $I_{I/O}=0.1mA, \overline{MUT}=V_{SS}$			0.9	V
Input Offset Voltage	V_{offset}	LIN, RIN; $V_{IN} \leq V_{DD}-3V$,	-50		50	mV
		$V_{IN} \leq V_{ref}, V_{IN}=0$ to 1V				
		LIN, RIN; $V_{IN} \leq V_{DD}-3V$,	-100		100	mV
		$V_{IN} \leq V_{ref}, V_{IN}=1$ to 5V				
AD Conversion Linear Error		Full scale input voltage=	-1/2		1/2	LSB
		2.5 to 5V				
Current Dissipation	I_{DD}	$f_{OSC}=26.7kHz, \overline{MUT}=V_{DD}$,		1.0	3.0	mA
		RIN, LIN=0V, other pin open				
Reference Supply Current	I_{ref}	V_{ref}			2.5	mA

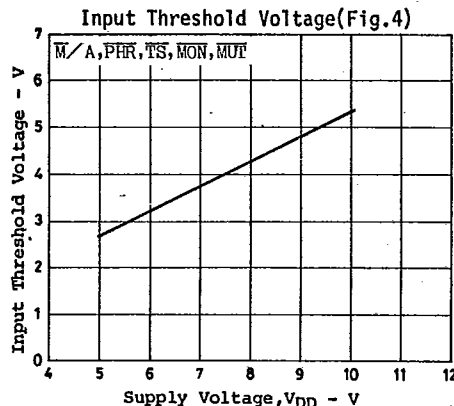
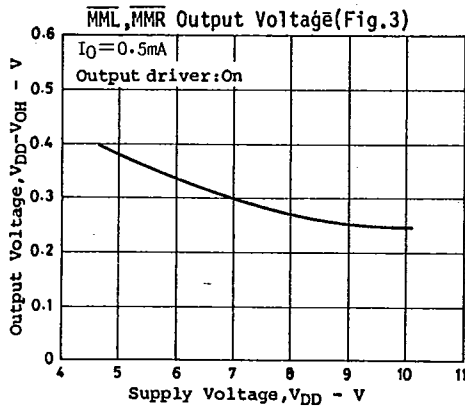
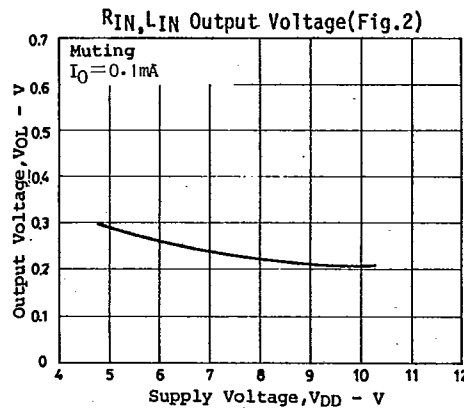
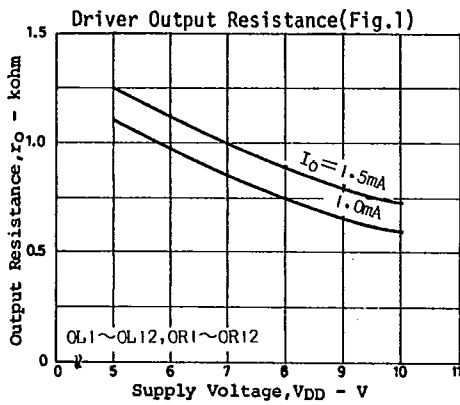

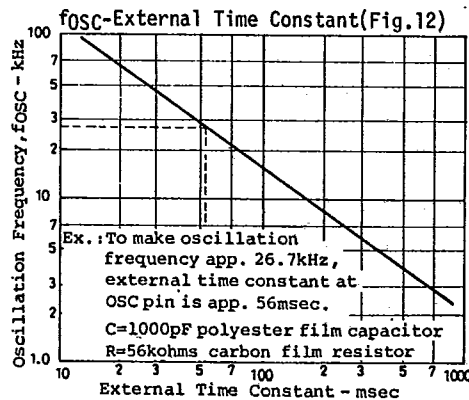
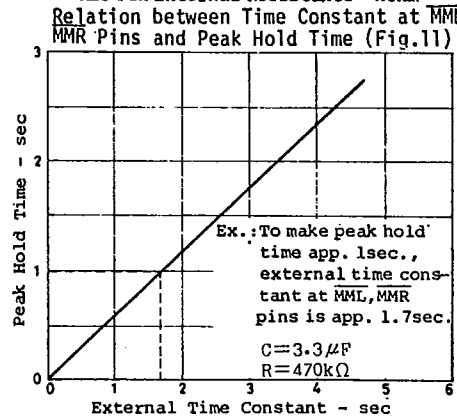
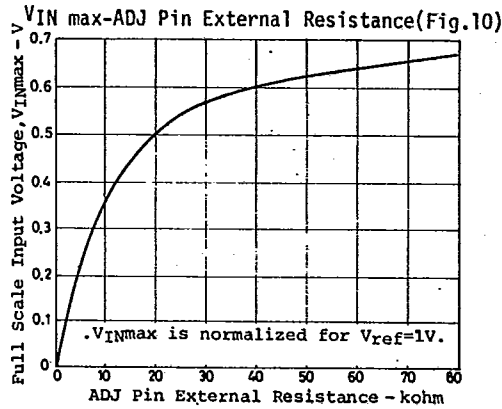
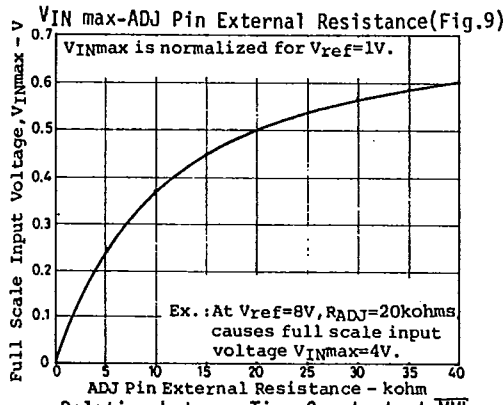
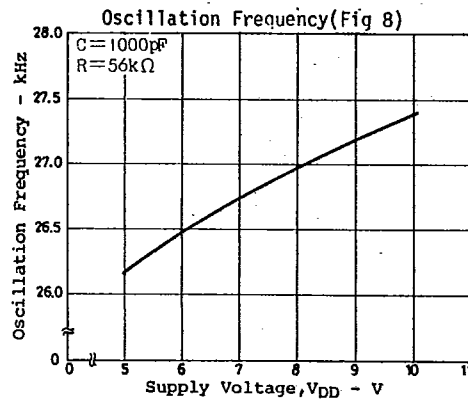
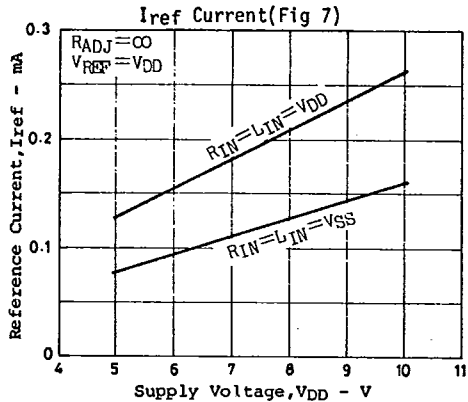
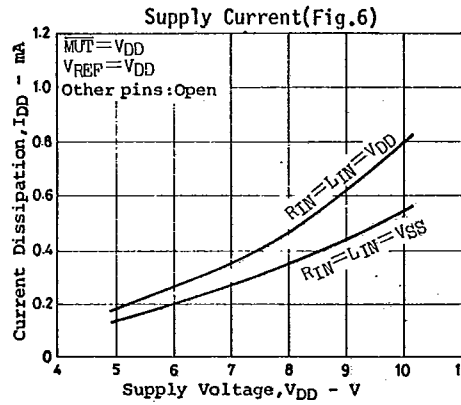
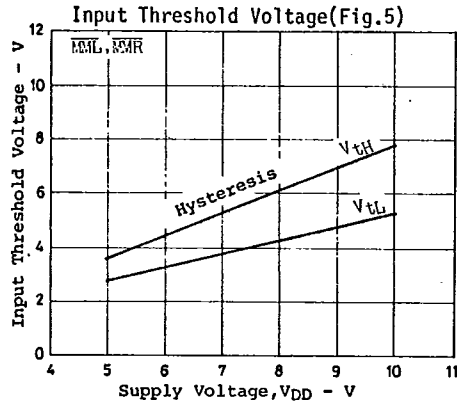

[查询"LC7555"供应商](#)

LC7555,7556

T-74-05-01

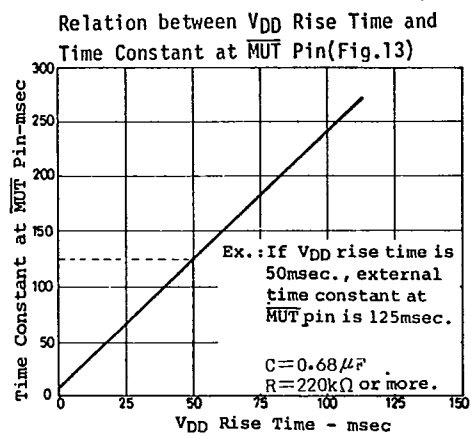

[查询"LC7555"供应商](#)

T-90-20

AUDIO-USE MOS IC CASE OUTLINES

- All of Sanyo audio-use MOS IC case outlines are illustrated below.
- All dimensions are in mm, and dimensions which are not followed by min. or max. are represented by typical values.
- No marking is indicated.

