

ST 2SA1458

[查询"2SA1458"供应商](#)

PNP Silicon Epitaxial Planar Transistor

for general purpose amplifier and high speed switching applications.

The transistor is subdivided into three groups M, L and K, according to its DC current gain.

On special request, these transistors can be manufactured in different pin configurations.

Features

- High frequency current gain
- High speed switching
- Small output capacitance
- Low collector saturation voltage
- Complementary to ST 2SC3731 NPN transistor

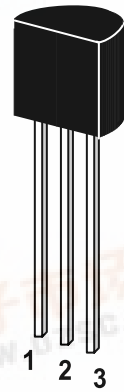

1. Emitter 2. Collector 3. Base

TO-92 Plastic Package

Weight approx. 0.19g

Absolute Maximum Ratings ($T_a = 25^\circ\text{C}$)

	Symbol	Value	Unit
Collector Base Voltage	$-V_{CB0}$	40	V
Collector Emitter Voltage	$-V_{CEO}$	40	V
Emitter Base Voltage	$-V_{EBO}$	5	V
Collector Current (DC)	$-I_C$	200	mA
Power Dissipation	P_{tot}	250	mW
Junction Temperature	T_j	150	$^\circ\text{C}$
Storage Temperature Range	T_s	-55 to+150	$^\circ\text{C}$

SEMTECH ELECTRONICS LTD.

(Subsidiary of Sino-Tech International Holdings Limited, a company listed on the Hong Kong Stock Exchange, Stock Code: 724)



Dated : 07/08/2003

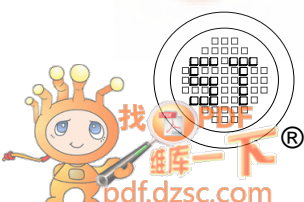

ST 2SA1458

[查询"2SA1458"供应商](#)

Characteristics at $T_{amb}=25\text{ }^{\circ}\text{C}$

	Symbol	Min.	Typ.	Max.	Unit
DC Current Gain*					
at $-V_{CE}=1\text{V}$, $-I_C=100\text{mA}$					
Current Gain Group M	h_{FE}	75	-	150	-
L	h_{FE}	100	-	200	-
K	h_{FE}	150	-	300	-
at $-V_{CE}=1\text{V}$, $-I_C=1\text{mA}$	h_{FE}	25	100	-	-
Collector Cutoff Current					
at $-V_{CB}=30\text{V}$	$-I_{CBO}$	-	-	0.1	μA
Emitter Cutoff Current					
at $-V_{EB}=3\text{V}$	$-I_{EBO}$	-	-	0.1	μA
Collector Saturation Voltage*					
at $-I_C=50\text{mA}$, $-I_B=5\text{mA}$	$-V_{CE(sat)}$	-	0.1	0.4	V
Base Saturation Voltage*					
at $-I_C=50\text{mA}$, $-I_B=5\text{mA}$	$-V_{BE(sat)}$	-	0.8	0.95	V
Turn-on Time					
See test circuit	t_{on}	-	-	70	ns
Storage Time					
See test circuit	t_{stg}	-	110	225	ns
Turn-off Time					
See test circuit	t_{off}	-	-	300	ns
Gain Bandwidth Product					
at $-V_{CE}=20\text{V}$, $I_E=10\text{mA}$, $f=100\text{MHz}$	f_T	200	510	-	MHz
Output Capacitance					
at $-V_{CB}=5\text{V}$, $f=1\text{MHz}$	C_{OB}	-	2.5	4.5	pF

*Pulsed $PW \leq 350\mu\text{s}$, Duty Cycle $\leq 2\%$

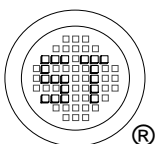

SEMTECH ELECTRONICS LTD.

(Subsidiary of Sino-Tech International Holdings Limited, a company listed on the Hong Kong Stock Exchange, Stock Code: 724)



ISO/TS 16949 : 2002
Certificate No. 05103



ISO 14001:2004
Certificate No. 7116



ISO 9001:2000
Certificate No. 0506098

Dated : 07/08/2003

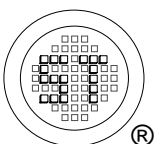
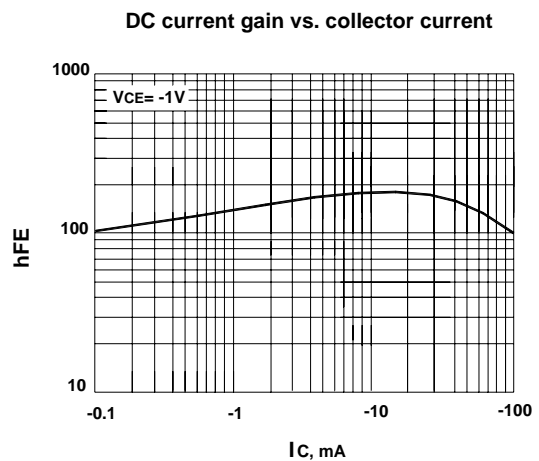
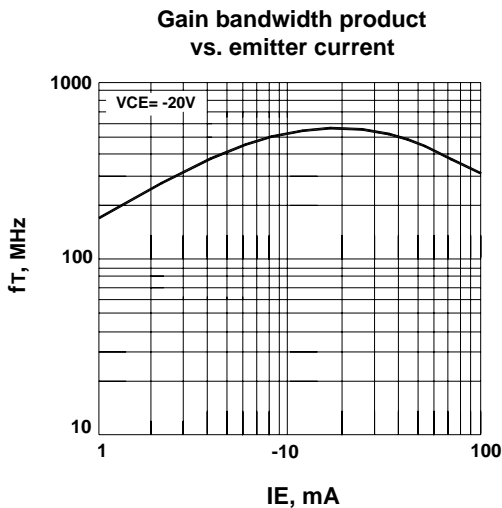
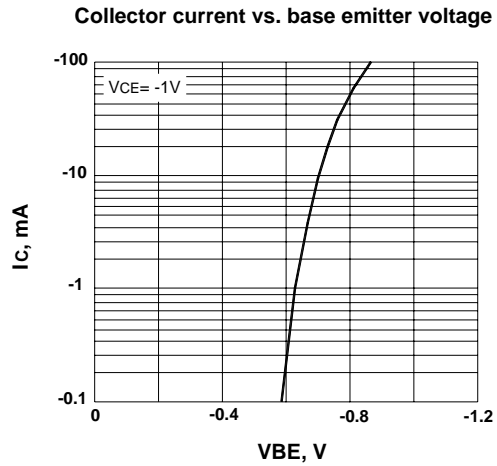
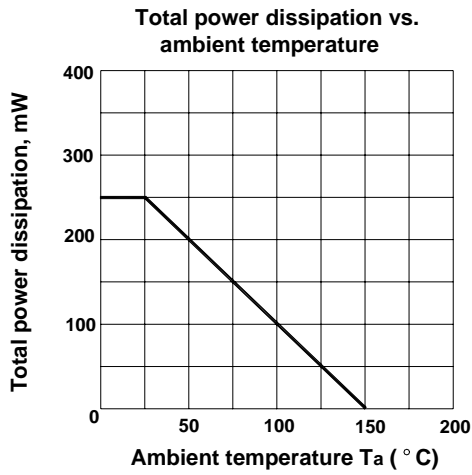
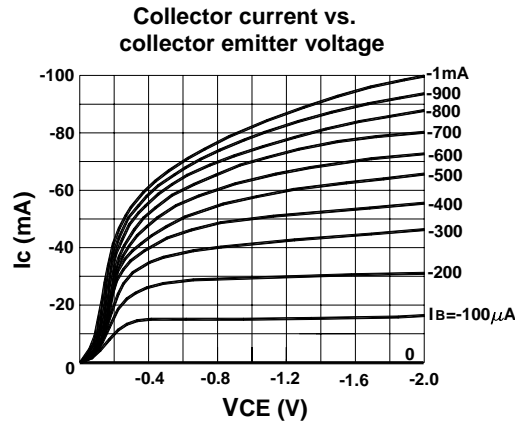
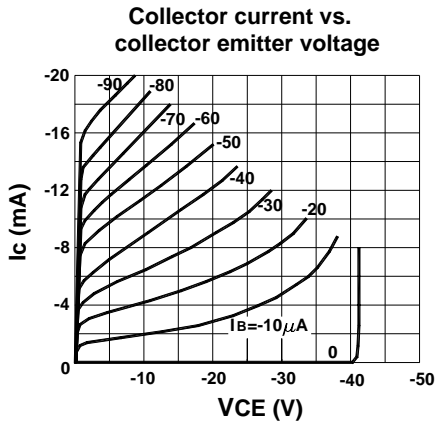

SEMTECH ELECTRONICS LTD.
 (Subsidiary of Sino-Tech International Holdings Limited, a company listed on the Hong Kong Stock Exchange, Stock Code: 724)

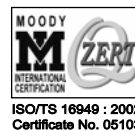

Base and collector saturation voltage vs. collector current

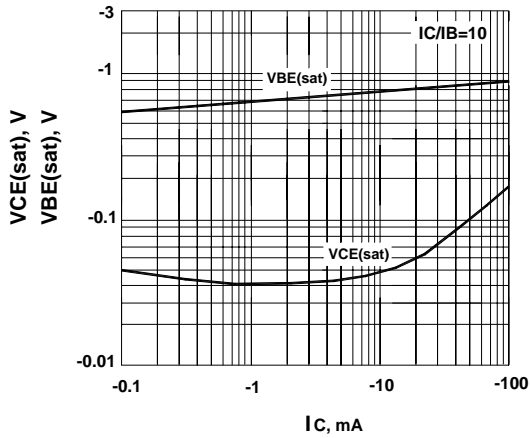

Input and output capacitance vs. reverse voltage

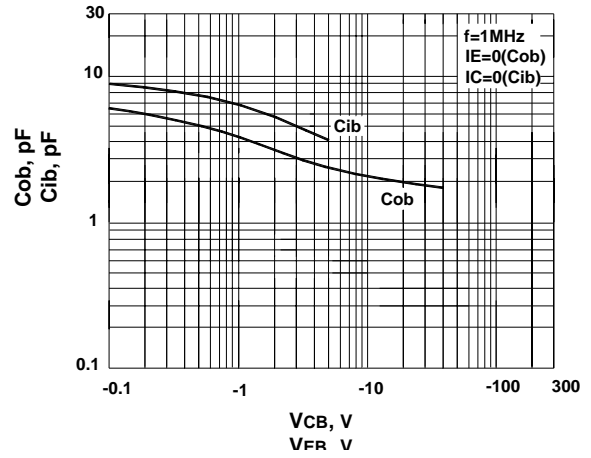

Turn on time vs. collector current

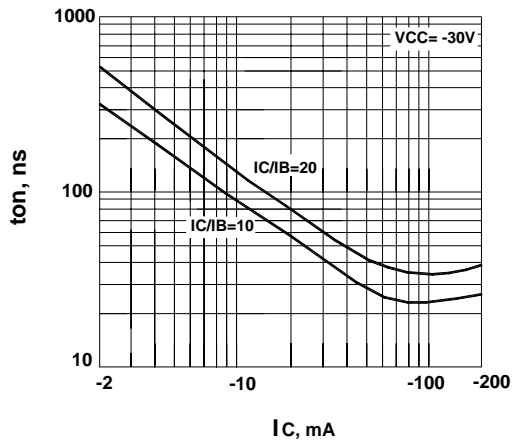

Rise time vs. collector current

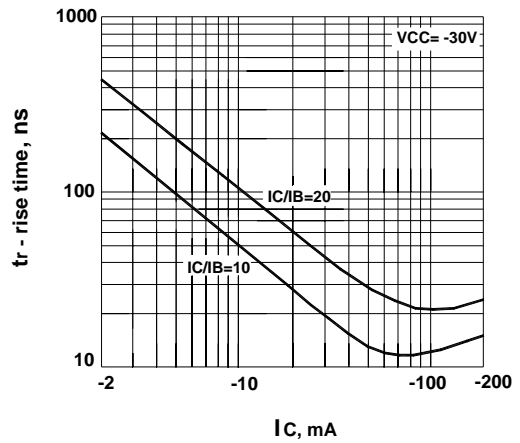

Storage time vs. collector current

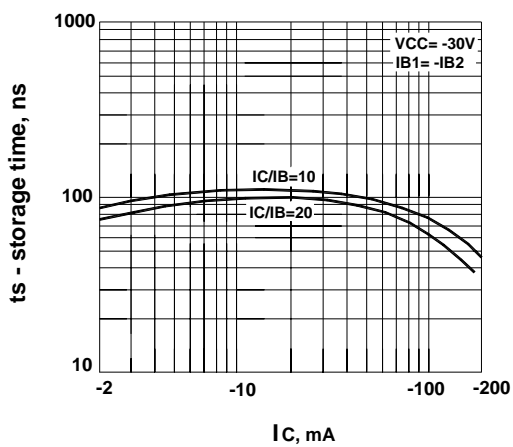

Fall time vs. collector current

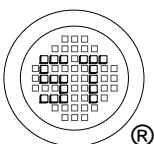
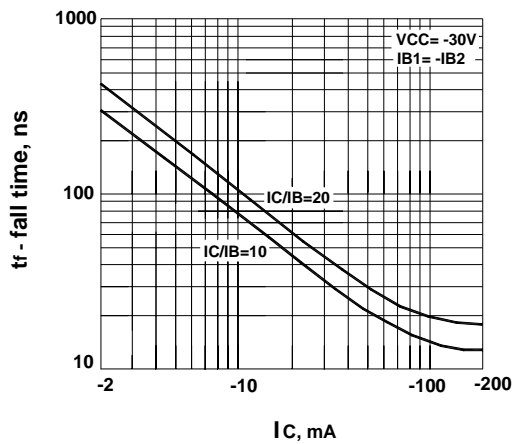

SEMTECH ELECTRONICS LTD.
 (Subsidiary of Sino-Tech International Holdings Limited, a company listed on the Hong Kong Stock Exchange, Stock Code: 724)

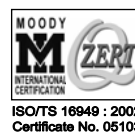

ISO/TS 16949 : 2002
 Certificate No. 05103

ISO 14001:2004
 Certificate No. 71116

ISO 9001:2000
 Certificate No. 0506098

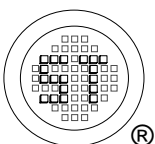
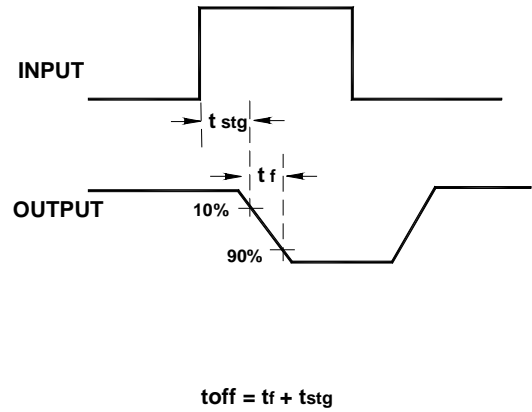
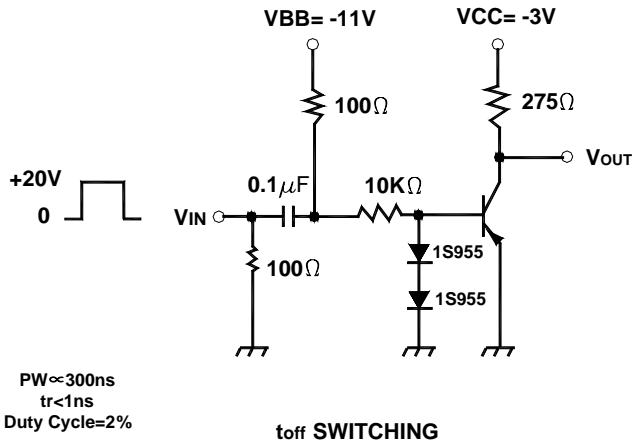
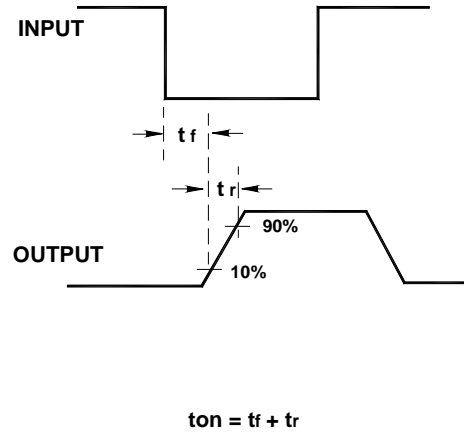
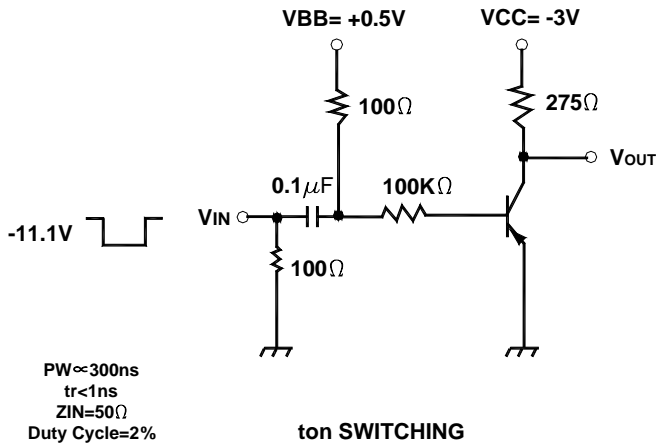

SEMTECH ELECTRONICS LTD.
 (Subsidiary of Sino-Tech International Holdings Limited, a company listed on the Hong Kong Stock Exchange, Stock Code: 724)

