

Presettable Divide-By-N Counter

The MC14018B contains five Johnson counter stages which are asynchronously presettable and resettable. The counters are synchronous, and increment on the positive going edge of the clock.

Presetting is accomplished by a logic 1 on the preset enable input. Data on the Jam inputs will then be transferred to their respective \bar{Q} outputs (inverted). A logic 1 on the reset input will cause all \bar{Q} outputs to go to a logic 1 state.

Division by any number from 2 to 10 can be accomplished by connecting appropriate \bar{Q} outputs to the data input, as shown in the Function Selection table. Anti-lock gating is included in the MC14018B to assure proper counting sequence.

- Fully Static Operation
- Schmitt Trigger on Clock Input
- Capable of Driving Two Low-power TTL Loads or One Low-power Schottky TTL Load Over the Rated Temperature Range
- Pin-for-Pin Replacement for CD4018B

MAXIMUM RATINGS (Voltages Referenced to V_{SS}) (Note NO TAG)

| Symbol | Parameter | Value | Unit |
|-------------------|---|------------------------|--------------------|
| V_{DD} | DC Supply Voltage Range | -0.5 to +18.0 | V |
| V_{in}, V_{out} | Input or Output Voltage Range (DC or Transient) | -0.5 to $V_{DD} + 0.5$ | V |
| I_{in}, I_{out} | Input or Output Current (DC or Transient) per Pin | ± 10 | mA |
| P_D | Power Dissipation, per Package (Note NO TAG) | 500 | mW |
| T_A | Ambient Temperature Range | -55 to +125 | $^{\circ}\text{C}$ |
| T_{stg} | Storage Temperature Range | -65 to +150 | $^{\circ}\text{C}$ |
| T_L | Lead Temperature (8-Second Soldering) | 260 | $^{\circ}\text{C}$ |

2. Maximum Ratings are those values beyond which damage to the device may occur.
3. Temperature Derating:
Plastic "P and D/DW" Packages: - 7.0 mW/ $^{\circ}\text{C}$ From 65 $^{\circ}\text{C}$ To 125 $^{\circ}\text{C}$

This device contains protection circuitry to guard against damage due to high static voltages or electric fields. However, precautions must be taken to avoid applications of any voltage higher than maximum rated voltages to this high-impedance circuit. For proper operation, V_{in} and V_{out} should be constrained to the range $V_{SS} \leq (V_{in} \text{ or } V_{out}) \leq V_{DD}$.

Unused inputs must always be tied to an appropriate logic voltage level (e.g., either V_{SS} or V_{DD}). Unused outputs must be left open.



ON Semiconductor

<http://onsemi.com>

MARKING DIAGRAMS

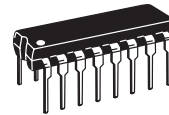

PDIP-16
P SUFFIX
CASE 648

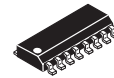

SOIC-16
D SUFFIX
CASE 751B

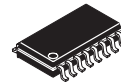
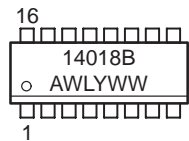

SOEIAJ-16
F SUFFIX
CASE 966

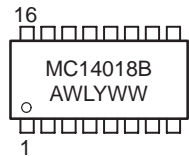

A = Assembly Location
WL or L = Wafer Lot
YY or Y = Year
WW or W = Work Week

ORDERING INFORMATION

| Device | Package | Shipping |
|-------------|-----------|------------------|
| MC14018BCP | PDIP-16 | 2000/Box |
| MC14018BD | SOIC-16 | 48/Rail |
| MC14018BDR2 | SOIC-16 | 2500/Tape & Reel |
| MC14018BF | SOEIAJ-16 | See Note 1. |
| MC14018BFEL | SOEIAJ-16 | See Note 1. |

1. For ordering information on the EIAJ version of the SOIC packages, please contact your local ON Semiconductor representative.



MC14018B

[查询"MC14018BCL"供应商](#)

PIN ASSIGNMENT

| | | | | |
|------------|---|---|----|------------|
| D_{in} | 1 | ● | 16 | V_{DD} |
| JAM 1 | 2 | | 15 | R |
| JAM 2 | 3 | | 14 | C |
| $\bar{Q}2$ | 4 | | 13 | $\bar{Q}5$ |
| $\bar{Q}1$ | 5 | | 12 | JAM 5 |
| $\bar{Q}3$ | 6 | | 11 | $\bar{Q}4$ |
| JAM 3 | 7 | | 10 | PE |
| V_{SS} | 8 | | 9 | JAM 4 |

FUNCTIONAL TRUTH TABLE

| Clock | Reset | Preset Enable | Jam Input | \bar{Q}_n |
|---|-------|---------------|-----------|---------------|
|  | 0 | 0 | X | \bar{Q}_n |
|  | 0 | 0 | X | \bar{D}_n^* |
| X | 0 | 1 | 0 | 1 |
| X | 0 | 1 | 1 | 0 |
| X | 1 | X | X | 1 |

* D_n is the Data input for that stage. Stage 1 has Data brought out to Pin 1.

MC14018B

ELECTRICAL CHARACTERISTICS (Voltages Referenced to V_{SS})

查询"MC14018BCL"供应商

| Characteristic | Symbol | V _{DD} Vdc | - 55°C | | 25°C | | | 125°C | | Unit |
|---|-----------------|------------------------|---|-------|--------|-----------|-------|--------|-------|------|
| | | | Min | Max | Min | Typ (4.) | Max | Min | Max | |
| Output Voltage "0" Level V _{in} = V _{DD} or 0 | V _{OL} | 5.0 | — | 0.05 | — | 0 | 0.05 | — | 0.05 | Vdc |
| | | 10 | — | 0.05 | — | 0 | 0.05 | — | 0.05 | |
| 15 | | — | 0.05 | — | 0 | 0.05 | — | 0.05 | | |
| V _{in} = 0 or V _{DD} "1" Level | V _{OH} | 5.0 | 4.95 | — | 4.95 | 5.0 | — | 4.95 | — | Vdc |
| 10 | | 9.95 | — | 9.95 | 10 | — | 9.95 | — | | |
| 15 | | 14.95 | — | 14.95 | 15 | — | 14.95 | — | | |
| Input Voltage "0" Level (V _O = 4.5 or 0.5 Vdc) (V _O = 9.0 or 1.0 Vdc) (V _O = 13.5 or 1.5 Vdc) | V _{IL} | 5.0 | — | 1.5 | — | 2.25 | 1.5 | — | 1.5 | Vdc |
| | | 10 | — | 3.0 | — | 4.50 | 3.0 | — | 3.0 | |
| | | 15 | — | 4.0 | — | 6.75 | 4.0 | — | 4.0 | |
| (V _O = 0.5 or 4.5 Vdc) "1" Level (V _O = 1.0 or 9.0 Vdc) (V _O = 1.5 or 13.5 Vdc) | V _{IH} | 5.0 | 3.5 | — | 3.5 | 2.75 | — | 3.5 | — | Vdc |
| | | 10 | 7.0 | — | 7.0 | 5.50 | — | 7.0 | — | |
| | | 15 | 11 | — | 11 | 8.25 | — | 11 | — | |
| Output Drive Current (V _{OH} = 2.5 Vdc) Source (V _{OH} = 4.6 Vdc) (V _{OH} = 9.5 Vdc) (V _{OH} = 13.5 Vdc) | I _{OH} | 5.0 | - 3.0 | — | - 2.4 | - 4.2 | — | - 1.7 | — | mAdc |
| | | 5.0 | - 0.64 | — | - 0.51 | - 0.88 | — | - 0.36 | — | |
| | | 10 | - 1.6 | — | - 1.3 | - 2.25 | — | - 0.9 | — | |
| | | 15 | - 4.2 | — | - 3.4 | - 8.8 | — | - 2.4 | — | |
| (V _{OL} = 0.4 Vdc) Sink (V _{OL} = 0.5 Vdc) (V _{OL} = 1.5 Vdc) | I _{OL} | 5.0 | 0.64 | — | 0.51 | 0.88 | — | 0.36 | — | mAdc |
| | | 10 | 1.6 | — | 1.3 | 2.25 | — | 0.9 | — | |
| | | 15 | 4.2 | — | 3.4 | 8.8 | — | 2.4 | — | |
| Input Current | I _{in} | 15 | — | ± 0.1 | — | ± 0.00001 | ± 0.1 | — | ± 1.0 | μAdc |
| Input Capacitance (V _{in} = 0) | C _{in} | — | — | — | — | 5.0 | 7.5 | — | — | pF |
| Quiescent Current (Per Package) | I _{DD} | 5.0 | — | 5.0 | — | 0.005 | 5.0 | — | 150 | μAdc |
| | | 10 | — | 10 | — | 0.010 | 10 | — | 300 | |
| | | 15 | — | 20 | — | 0.015 | 20 | — | 600 | |
| Total Supply Current (5.) (6.) (Dynamic plus Quiescent, Per Package) (C _L = 50 pF on all outputs, all buffers switching) | I _T | 5.0 | I _T = (0.3 μA/kHz) f + I _{DD} | | | | | | | μAdc |
| | | 10 | I _T = (0.7 μA/kHz) f + I _{DD} | | | | | | | |
| | | 15 | I _T = (1.0 μA/kHz) f + I _{DD} | | | | | | | |

4. Data labelled "Typ" is not to be used for design purposes but is intended as an indication of the IC's potential performance.

5. The formulas given are for the typical characteristics only at 25°C.

6. To calculate total supply current at loads other than 50 pF:

$$I_T(C_L) = I_T(50 \text{ pF}) + (C_L - 50) Vfk$$

where: I_T is in μA (per package), C_L in pF, V = (V_{DD} - V_{SS}) in volts, f in kHz is input frequency, and k = 0.001.

MC14018B

SWITCHING CHARACTERISTICS ^(7.) ($C_L = 50 \text{ pF}$, $T_A = 25^\circ\text{C}$)

| Characteristic | Symbol | V_{DD} Vdc | All Types | | | Unit |
|--|--------------------------|-----------------|-------------------|---------------------|---------------------|------|
| | | | Min | Typ ^(8.) | Max | |
| Output Rise and Fall Time t_{TLH} , $t_{THL} = (1.35 \text{ ns/pF}) C_L + 32 \text{ ns}$ t_{TLH} , $t_{THL} = (0.6 \text{ ns/pF}) C_L + 20 \text{ ns}$ t_{TLH} , $t_{THL} = (0.4 \text{ ns/pF}) C_L + 20 \text{ ns}$ | t_{TLH} , t_{THL} | 5.0 10 15 | — — — | 100 50 40 | 200 100 80 | ns |
| Propagation Delay Time Clock to \bar{Q} t_{PLH} , $t_{PHL} = (0.90 \text{ ns/pF}) C_L + 265 \text{ ns}$ t_{PLH} , $t_{PHL} = (0.36 \text{ ns/pF}) C_L + 102 \text{ ns}$ t_{PLH} , $t_{PHL} = (0.26 \text{ ns/pF}) C_L + 72 \text{ ns}$ | t_{PLH} , t_{PHL} | 5.0 10 15 | — — — | 310 120 85 | 620 240 170 | ns |
| Reset to \bar{Q} $t_{PLH} = (0.90 \text{ ns/pF}) C_L + 325 \text{ ns}$ $t_{PLH} = (0.36 \text{ ns/pF}) C_L + 132 \text{ ns}$ $t_{PLH} = (0.26 \text{ ns/pF}) C_L + 81 \text{ ns}$ | | 5.0 10 15 | — — — | 370 150 100 | 740 300 200 | ns |
| Preset Enable to \bar{Q} t_{PLH} , $t_{PHL} = (0.90 \text{ ns/pF}) C_L + 325 \text{ ns}$ t_{PLH} , $t_{PHL} = (0.36 \text{ ns/pF}) C_L + 132 \text{ ns}$ t_{PLH} , $t_{PHL} = (0.26 \text{ ns/pF}) C_L + 81 \text{ ns}$ | | 5.0 10 15 | — — — | 370 150 100 | 740 300 200 | ns |
| Setup Time Data (Pin 1) to Clock | t_{su} | 5.0 10 15 | 200 100 80 | 0 0 0 | — — — | ns |
| Jam Inputs to Preset Enable | | 5.0 10 15 | 200 100 80 | 0 0 0 | — — — | ns |
| Data (Jam Inputs)–to–Preset Enable Hold Time | t_h | 5.0 10 15 | 540 500 480 | 270 250 240 | — — — | ns |
| Clock Pulse Width | t_{WH} | 5.0 10 15 | 400 200 160 | 200 100 80 | — — — | ns |
| Reset or Preset Enable Pulse Width | t_{WH} | 5.0 10 15 | 290 130 110 | 145 65 55 | — — — | ns |
| Clock Rise and Fall Time | t_{TLH} , t_{THL} | 5.0 10 15 | No Limit | | | ns |
| Clock Pulse Frequency | f_{cl} | 5.0 10 15 | — — — | 2.5 6.5 8.0 | 1.25 3.25 4.0 | MHz |

7. The formulas given are for the typical characteristics only at 25°C.

8. Data labelled "Typ" is not to be used for design purposes but is intended as an indication of the IC's potential performance.

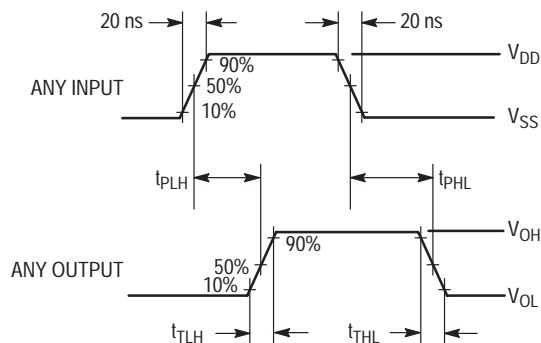
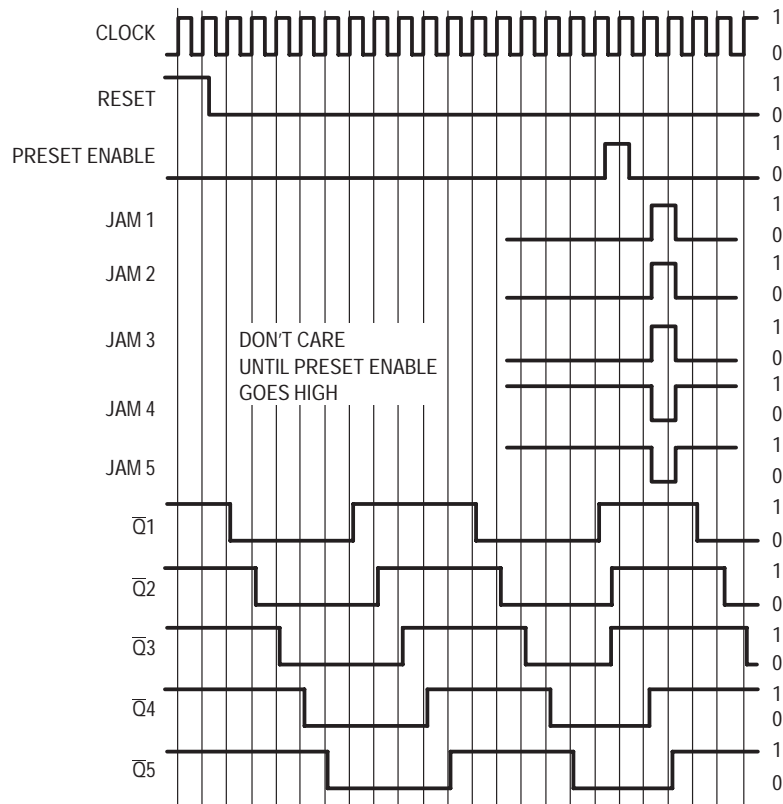

Figure 1. Switching Time Waveforms

MC14018B

[查询"MC14018BCL"供应商](#)

TIMING DIAGRAM
($\bar{Q}5$ Connected to Data Input)



FUNCTION SELECTION

| Counter Mode | Connect Data Input (Pin 1) to: | Comments |
|--|--|--|
| Divide by 10 Divide by 8 Divide by 6 Divide by 4 Divide by 2 | $\bar{Q}5$ $\bar{Q}4$ $\bar{Q}3$ $\bar{Q}2$ $\bar{Q}1$ | No external components needed. |
| Divide by 9 Divide by 7 Divide by 5 Divide by 3 | $\bar{Q}5 \cdot \bar{Q}4$ $\bar{Q}4 \cdot \bar{Q}3$ $\bar{Q}3 \cdot \bar{Q}2$ $\bar{Q}2 \cdot \bar{Q}1$ | Gate package needed to provide AND function. Counter Skips all 1's state |

LOGIC DIAGRAM

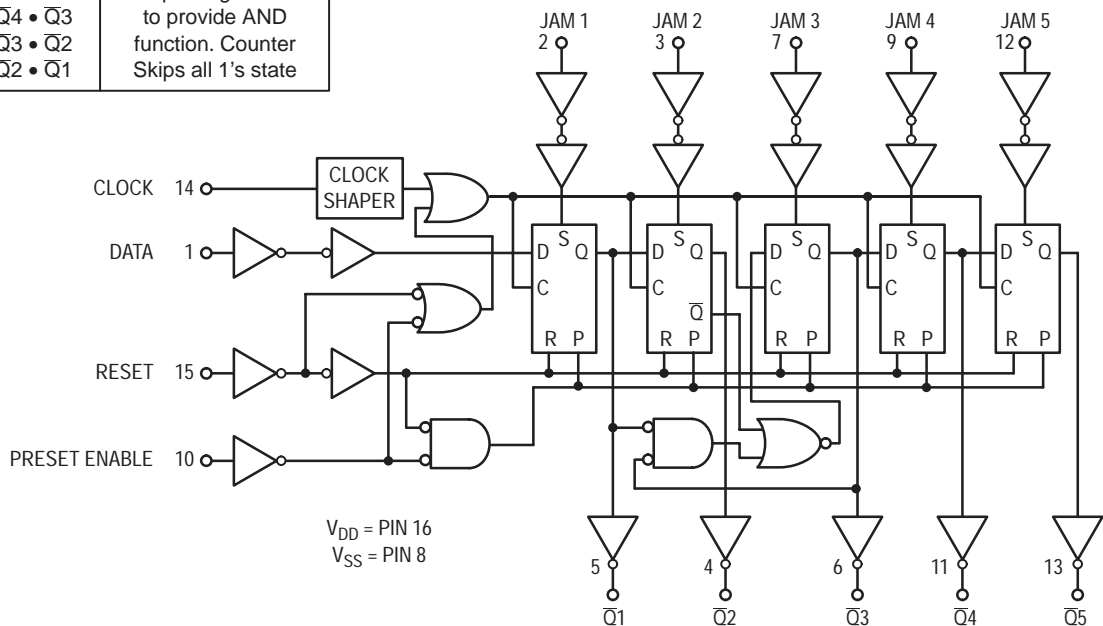

MC14018B

[查询"MC14018BCL"供应商](#)

PACKAGE DIMENSIONS

PDIP-16 P SUFFIX PLASTIC DIP PACKAGE CASE 648-08 ISSUE R

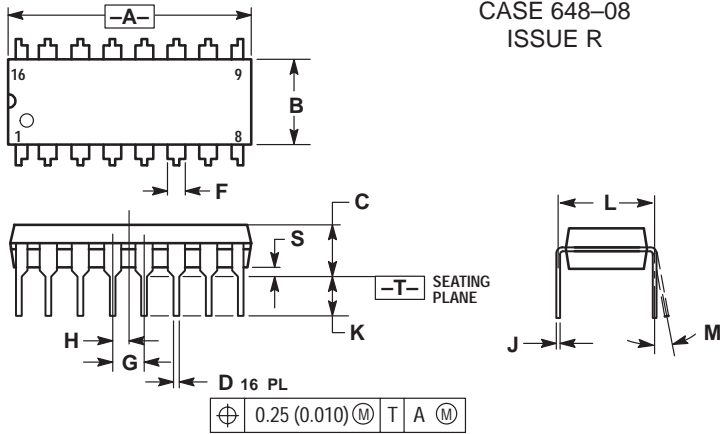

- NOTES:
1. DIMENSIONING AND TOLERANCING PER ANSI Y14.5M, 1982.
 2. CONTROLLING DIMENSION: INCH.
 3. DIMENSION L TO CENTER OF LEADS WHEN FORMED PARALLEL.
 4. DIMENSION B DOES NOT INCLUDE MOLD FLASH.
 5. ROUNDED CORNERS OPTIONAL.

| DIM | INCHES | | MILLIMETERS | |
|-----|-----------|-------|-------------|-------|
| | MIN | MAX | MIN | MAX |
| A | 0.740 | 0.770 | 18.80 | 19.55 |
| B | 0.250 | 0.270 | 6.35 | 6.85 |
| C | 0.145 | 0.175 | 3.69 | 4.44 |
| D | 0.015 | 0.021 | 0.39 | 0.53 |
| F | 0.040 | 0.70 | 1.02 | 1.77 |
| G | 0.100 BSC | | 2.54 BSC | |
| H | 0.050 BSC | | 1.27 BSC | |
| J | 0.008 | 0.015 | 0.21 | 0.38 |
| K | 0.110 | 0.130 | 2.80 | 3.30 |
| L | 0.295 | 0.305 | 7.50 | 7.74 |
| M | 0° | 10° | 0° | 10° |
| S | 0.020 | 0.040 | 0.51 | 1.01 |

SOIC-16 D SUFFIX PLASTIC SOIC PACKAGE CASE 751B-05 ISSUE J

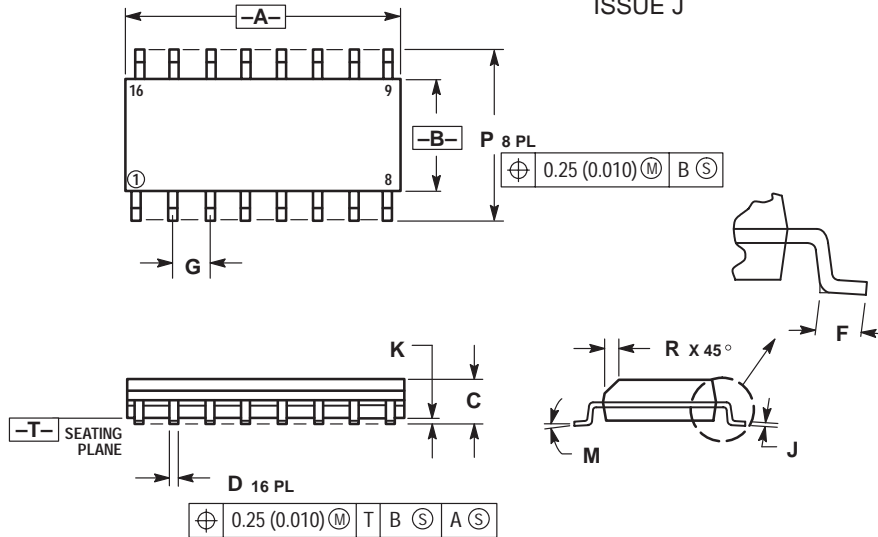

- NOTES:
1. DIMENSIONING AND TOLERANCING PER ANSI Y14.5M, 1982.
 2. CONTROLLING DIMENSION: MILLIMETER.
 3. DIMENSIONS A AND B DO NOT INCLUDE MOLD PROTRUSION.
 4. MAXIMUM MOLD PROTRUSION 0.15 (0.006) PER SIDE.
 5. DIMENSION D DOES NOT INCLUDE DAMBAR PROTRUSION. ALLOWABLE DAMBAR PROTRUSION SHALL BE 0.127 (0.005) TOTAL IN EXCESS OF THE D DIMENSION AT MAXIMUM MATERIAL CONDITION.

| DIM | MILLIMETERS | | INCHES | |
|-----|-------------|-------|-----------|-------|
| | MIN | MAX | MIN | MAX |
| A | 9.80 | 10.00 | 0.386 | 0.393 |
| B | 3.80 | 4.00 | 0.150 | 0.157 |
| C | 1.35 | 1.75 | 0.054 | 0.068 |
| D | 0.35 | 0.49 | 0.014 | 0.019 |
| F | 0.40 | 1.25 | 0.016 | 0.049 |
| G | 1.27 BSC | | 0.050 BSC | |
| J | 0.19 | 0.25 | 0.008 | 0.009 |
| K | 0.10 | 0.25 | 0.004 | 0.009 |
| M | 0° | 7° | 0° | 7° |
| P | 5.80 | 6.20 | 0.229 | 0.244 |
| R | 0.25 | 0.50 | 0.010 | 0.019 |

MC14018B

[查询"MC14018BCL"供应商](#)

PACKAGE DIMENSIONS

SOEIAJ-16 F SUFFIX PLASTIC EIAJ SOIC PACKAGE CASE 966-01 ISSUE O

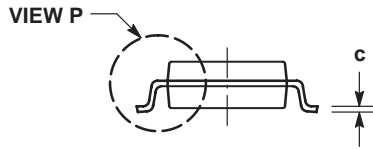
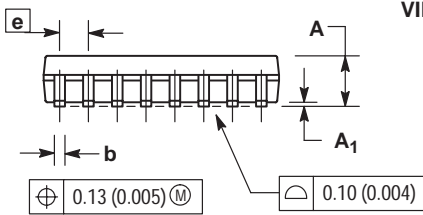
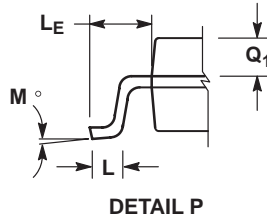
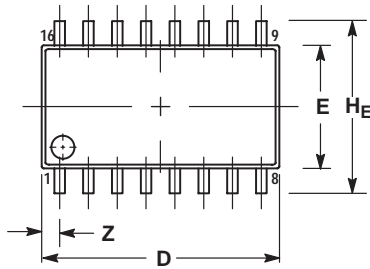

NOTES:

1. DIMENSIONING AND TOLERANCING PER ANSI Y14.5M, 1982.
2. CONTROLLING DIMENSION: MILLIMETER.
3. DIMENSIONS D AND E DO NOT INCLUDE MOLD FLASH OR PROTRUSIONS AND ARE MEASURED AT THE PARTING LINE. MOLD FLASH OR PROTRUSIONS SHALL NOT EXCEED 0.15 (0.006) PER SIDE.
4. TERMINAL NUMBERS ARE SHOWN FOR REFERENCE ONLY.
5. THE LEAD WIDTH DIMENSION (b) DOES NOT INCLUDE DAMBAR PROTRUSION. ALLOWABLE DAMBAR PROTRUSION SHALL BE 0.08 (0.003) TOTAL IN EXCESS OF THE LEAD WIDTH DIMENSION AT MAXIMUM MATERIAL CONDITION. DAMBAR CANNOT BE LOCATED ON THE LOWER RADIUS OR THE FOOT. MINIMUM SPACE BETWEEN PROTRUSIONS AND ADJACENT LEAD TO BE 0.46 (0.018).

| DIM | MILLIMETERS | | INCHES | |
|----------------|-------------|-------|-----------|-------|
| | MIN | MAX | MIN | MAX |
| A | --- | 2.05 | --- | 0.081 |
| A ₁ | 0.05 | 0.20 | 0.002 | 0.008 |
| b | 0.35 | 0.50 | 0.014 | 0.020 |
| c | 0.18 | 0.27 | 0.007 | 0.011 |
| D | 9.90 | 10.50 | 0.390 | 0.413 |
| E | 5.10 | 5.45 | 0.201 | 0.215 |
| e | 1.27 BSC | | 0.050 BSC | |
| H _E | 7.40 | 8.20 | 0.291 | 0.323 |
| L | 0.50 | 0.85 | 0.020 | 0.033 |
| L _E | 1.10 | 1.50 | 0.043 | 0.059 |
| M | 0° | 10° | 0° | 10° |
| Q ₁ | 0.70 | 0.90 | 0.028 | 0.035 |
| Z | --- | 0.78 | --- | 0.031 |

ON Semiconductor and  are trademarks of Semiconductor Components Industries, LLC (SCILLC). SCILLC reserves the right to make changes without further notice to any products herein. SCILLC makes no warranty, representation or guarantee regarding the suitability of its products for any particular purpose, nor does SCILLC assume any liability arising out of the application or use of any product or circuit, and specifically disclaims any and all liability, including without limitation special, consequential or incidental damages. "Typical" parameters which may be provided in SCILLC data sheets and/or specifications can and do vary in different applications and actual performance may vary over time. All operating parameters, including "Typicals" must be validated for each customer application by customer's technical experts. SCILLC does not convey any license under its patent rights nor the rights of others. SCILLC products are not designed, intended, or authorized for use as components in systems intended for surgical implant into the body, or other applications intended to support or sustain life, or for any other application in which the failure of the SCILLC product could create a situation where personal injury or death may occur. Should Buyer purchase or use SCILLC products for any such unintended or unauthorized application, Buyer shall indemnify and hold SCILLC and its officers, employees, subsidiaries, affiliates, and distributors harmless against all claims, costs, damages, and expenses, and reasonable attorney fees arising out of, directly or indirectly, any claim of personal injury or death associated with such unintended or unauthorized use, even if such claim alleges that SCILLC was negligent regarding the design or manufacture of the part. SCILLC is an Equal Opportunity/Affirmative Action Employer.

PUBLICATION ORDERING INFORMATION

NORTH AMERICA Literature Fulfillment:

Literature Distribution Center for ON Semiconductor
P.O. Box 5163, Denver, Colorado 80217 USA
Phone: 303-675-2175 or 800-344-3860 Toll Free USA/Canada
Fax: 303-675-2176 or 800-344-3867 Toll Free USA/Canada
Email: ONlit@hibbertco.com
Fax Response Line: 303-675-2167 or 800-344-3810 Toll Free USA/Canada

N. American Technical Support: 800-282-9855 Toll Free USA/Canada

EUROPE: LDC for ON Semiconductor – European Support

German Phone: (+1) 303-308-7140 (M-F 1:00pm to 5:00pm Munich Time)
Email: ONlit-german@hibbertco.com
French Phone: (+1) 303-308-7141 (M-F 1:00pm to 5:00pm Toulouse Time)
Email: ONlit-french@hibbertco.com
English Phone: (+1) 303-308-7142 (M-F 12:00pm to 5:00pm UK Time)
Email: ONlit@hibbertco.com

EUROPEAN TOLL-FREE ACCESS*: 00-800-4422-3781

*Available from Germany, France, Italy, England, Ireland

CENTRAL/SOUTH AMERICA:

Spanish Phone: 303-308-7143 (Mon-Fri 8:00am to 5:00pm MST)
Email: ONlit-spanish@hibbertco.com

ASIA/PACIFIC: LDC for ON Semiconductor – Asia Support

Phone: 303-675-2121 (Tue-Fri 9:00am to 1:00pm, Hong Kong Time)
Toll Free from Hong Kong & Singapore:
001-800-4422-3781
Email: ONlit-asia@hibbertco.com

JAPAN: ON Semiconductor, Japan Customer Focus Center
4-32-1 Nishi-Gotanda, Shinagawa-ku, Tokyo, Japan 141-8549

Phone: 81-3-5740-2745
Email: r14525@onsemi.com

ON Semiconductor Website: <http://onsemi.com>

For additional information, please contact your local Sales Representative.