

# LM4908 Boomer® Audio Power Amplifier Series

## 10kV ESD Rated, Dual 120 mW Headphone Amplifier

### General Description

The LM4908 is a dual audio power amplifier capable of delivering 120mW per channel of continuous average power into a 16Ω load with 0.1% (THD+N) from a 5V power supply. Boomer audio power amplifiers were designed specifically to provide high quality output power with a minimal amount of external components using surface mount packaging. Since the LM4908 does not require bootstrap capacitors or snubber networks, it is optimally suited for low-power portable systems.

The unity-gain stable LM4908 can be configured by external gain-setting resistors.

### Key Specifications

- THD+N at 1kHz at 120mW continuous average output power into 16Ω 0.1% (typ)
- THD+N at 1kHz at 75mW continuous average output power into 32Ω 0.1% (typ)

- Output power at 0.1% THD+N at 1kHz into 32Ω 75mW (typ)

### Features

- Up to 10kV ESD protection on all pins
- MSOP, SOP, and LLP surface mount packaging
- Switch on/off click suppression
- Excellent power supply ripple rejection
- Unity-gain stable
- Minimum external components

### Applications

- Headphone Amplifier
- Personal Computers
- Portable electronic devices

### Typical Application

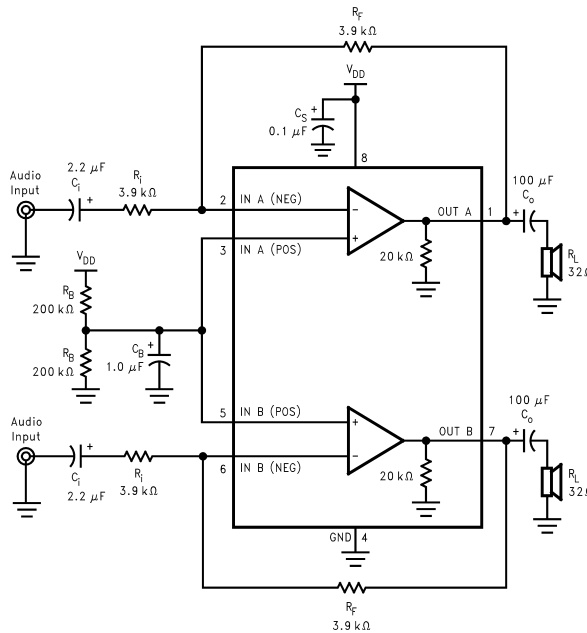

20075201

\*Refer to the **Application Information** Section for information concerning proper selection of the input and output coupling capacitors.

**FIGURE 1. Typical Audio Amplifier Application Circuit**

Boomer® is a registered trademark of National Semiconductor Corporation.

10kV ESD Rated, Dual 120 mW Headphone Amplifier

## Connection Diagrams

[查询"LM4908MM"供应商](#)

### SOP (MA) and MSOP (MM) Package

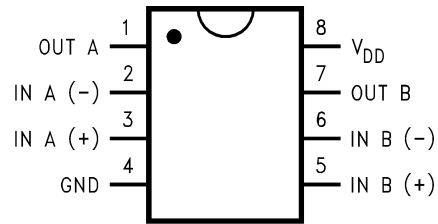

20075202

#### Top View

Order Number LM4908MA, LM4908MM  
See NS Package Number M08A, MUA08A

### LLP (LQ) Package

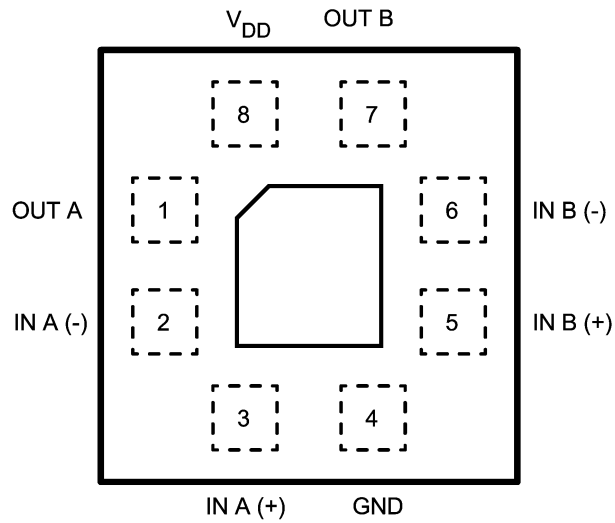

200752A2

#### Top View

Order Number LM4908LQ  
See NS Package Number LQB08A

**Absolute Maximum Ratings** (Note 3)

If **ilitary/Aerospace specified devices are required, please contact the National Semiconductor Sales Office/ Distributors for availability and specifications.**

Supply Voltage	6.0V
Storage Temperature	-65°C to +150°C
Input Voltage	-0.3V to $V_{DD} + 0.3V$
Power Dissipation (Note 4)	Internally limited
ESD Susceptibility (Note 5)	10.0kV
ESD Susceptibility (Note 6)	500V
Junction Temperature	150°C
Soldering Information (Note 1)	
Small Outline Package	
Vapor Phase (60 seconds)	215°C
Infrared (15 seconds)	220°C
Thermal Resistance	

$\theta_{JC}$ (MSOP)	56°C/W
$\theta_{JA}$ (MSOP)	210°C/W
$\theta_{JC}$ (SOP)	35°C/W
$\theta_{JA}$ (SOP)	170°C/W
$\theta_{JC}$ (LLP)	15°C/W
$\theta_{JA}$ (LLP)	117°C/W (Note 9)
$\theta_{JA}$ (LLP)	150°C/W (Note 10)

**Operating Ratings**

Temperature Range	
$T_{MIN} \leq T_A \leq T_{MAX}$	-40°C $\leq T_A \leq$ 85°C
Supply Voltage	2.0V $\leq V_{DD} \leq$ 5.5V

**Note 1:** See AN-450 "Surface Mounting and their Effects on Product Reliability" for other methods of soldering surface mount devices.

**Electrical Characteristics** (Notes 2, 3)

The following specifications apply for  $V_{DD} = 5V$  unless otherwise specified, limits apply to  $T_A = 25^\circ C$ .

Symbol	Parameter	Conditions	LM4908		Units (Limits)
			Typ (Note 7)	Limit (Note 8)	
$V_{DD}$	Supply Voltage			2.0	V (min)
				5.5	V (max)
$I_{DD}$	Supply Current	$V_{IN} = 0V, I_O = 0A$	1.6	3.0	mA (max)
$P_{tot}$	Total Power Dissipation	$V_{IN} = 0V, I_O = 0A$	8	16.5	mW (max)
$V_{OS}$	Input Offset Voltage	$V_{IN} = 0V$	5	50	mV (max)
$I_{bias}$	Input Bias Current		10		pA
$V_{CM}$	Common Mode Voltage		0		V
			4.3		V
$G_V$	Open-Loop Voltage Gain	$R_L = 5k\Omega$	67		dB
$I_O$	Max Output Current	THD+N < 0.1 %	70		mA
$R_O$	Output Resistance		0.1		$\Omega$
$V_O$	Output Swing	$R_L = 32\Omega, 0.1\% \text{ THD+N, Min}$	.3		V
		$R_L = 32\Omega, 0.1\% \text{ THD+N, Max}$	4.7		
PSRR	Power Supply Rejection Ratio	$C_b = 1.0\mu F, V_{ripple} = 100mV_{PP}, f = 40Hz$	90		dB
Crosstalk	Channel Separation	$R_L = 32\Omega, f = 1kHz$	82		dB
THD+N	Total Harmonic Distortion + Noise	$f = 1 \text{ kHz}$			
		$R_L = 16\Omega, V_O = 3.5V_{PP} \text{ (at 0 dB)}$	0.05		%
			66		dB
		$R_L = 32\Omega, V_O = 3.5V_{PP} \text{ (at 0 dB)}$	0.05		%
			66		dB
SNR	Signal-to-Noise Ratio	$V_O = 3.5V_{PP} \text{ (at 0 dB)}$	100		dB
$f_G$	Unity Gain Frequency	Open Loop, $R_L = 5k\Omega$	25		MHz
$P_O$	Output Power	THD+N = 0.1%, $f = 1 \text{ kHz}$			
		$R_L = 16\Omega$	120		mW
		$R_L = 32\Omega$	75	60	mW
		THD+N = 10%, $f = 1 \text{ kHz}$			
		$R_L = 16\Omega$	157		mW
			99		mW
$C_I$	Input Capacitance		3		pF

**Electrical Characteristics** (Notes 2, 3) (Continued)

The following specifications apply for  $V_{DD} = 5V$  unless otherwise specified, limits apply to  $T_A = 25^\circ C$ .

Symbol	Parameter	Conditions	LM4908		Units (Limits)
			Typ (Note 7)	Limit (Note 8)	
$C_L$	Load Capacitance			200	pF
SR	Slew Rate	Unity Gain Inverting	3		V/ $\mu$ s

**Electrical Characteristics** (Notes 2, 3)

The following specifications apply for  $V_{DD} = 3.3V$  unless otherwise specified, limits apply to  $T_A = 25^\circ C$ .

Symbol	Parameter	Conditions	Conditions		Units (Limits)
			Typ (Note 7)	Limit (Note 8)	
$I_{DD}$	Supply Current	$V_{IN} = 0V, I_O = 0A$	1.4		mA (max)
$V_{OS}$	Input Offset Voltage	$V_{IN} = 0V$	5		mV (max)
$P_o$	Output Power	THD+N = 0.1%, f = 1 kHz			
		$R_L = 16\Omega$	43		mW
		$R_L = 32\Omega$	30		mW
		THD+N = 10%, f = 1 kHz			
		$R_L = 16\Omega$	61		mW
		$R_L = 32\Omega$	41		mW

**Electrical Characteristics** (Notes 2, 3)

The following specifications apply for  $V_{DD} = 2.6V$  unless otherwise specified, limits apply to  $T_A = 25^\circ C$ .

Symbol	Parameter	Conditions	Conditions		Units (Limits)
			Typ (Note 7)	Limit (Note 8)	
$I_{DD}$	Supply Current	$V_{IN} = 0V, I_O = 0A$	1.3		mA (max)
$V_{OS}$	Input Offset Voltage	$V_{IN} = 0V$	5		mV (max)
$P_o$	Output Power	THD+N = 0.1%, f = 1 kHz			
		$R_L = 16\Omega$	20		mW
		$R_L = 32\Omega$	16		mW
		THD+N = 10%, f = 1 kHz			
		$R_L = 16\Omega$	34		mW
		$R_L = 32\Omega$	24		mW

**Note 2:** All voltages are measured with respect to the ground pin, unless otherwise specified.

**Note 3:** *Absolute Maximum Ratings* indicate limits beyond which damage to the device may occur. *Operating Ratings* indicate conditions for which the device is functional, but do not guarantee specific performance limits. *Electrical Characteristics* state DC and AC electrical specifications under particular test conditions which guarantee specific performance limits. This assumes that the device is within the Operating Ratings. Specifications are not guaranteed for parameters where no limit is given, however, the typical value is a good indication of device performance.

**Note 4:** The maximum power dissipation must be derated at elevated temperatures and is dictated by  $T_{JMAX}$ ,  $\theta_{JA}$ , and the ambient temperature  $T_A$ . The maximum allowable power dissipation is  $P_{DMAX} = (T_{JMAX} - T_A) / \theta_{JA}$ . For the LM4908,  $T_{JMAX} = 150^\circ C$ , and the typical junction-to-ambient thermal resistance, when board mounted, is  $210^\circ C/W$  for package MUA08A and  $170^\circ C/W$  for package M08A.

**Note 5:** Human body model, 100pF discharged through a 1.5k $\Omega$  resistor.

**Note 6:** Machine Model, 220pF–240pF discharged through all pins.

**Note 7:** Typicals are measured at  $25^\circ C$  and represent the parametric norm.

**Note 8:** Tested limits are guaranteed to National's AOQL (Average Outgoing Quality Level). Datasheet min/max specification limits are guaranteed by design, test, or statistical analysis.

**Note 9:** The given  $\theta_{JA}$  is for an LM4908 packaged in an LQB08A with the Exposed-DAP soldered to a printed circuit board copper pad with an area equivalent to that of the Exposed-DAP itself.

**Note 10:** The given  $\theta_{JA}$  is for an LM4908 packaged in an LQB08A with the Exposed-DAP not soldered to any printed circuit board copper.

## External Components Description (Figure 1)

查询"LM4908MM"供应商

Components	Functional Description
1. $R_i$	The inverting input resistance, along with $R_f$ , set the closed-loop gain. $R_i$ , along with $C_i$ , form a high pass filter with $f_c = 1/(2\pi R_i C_i)$ .
2. $C_i$	The input coupling capacitor blocks DC voltage at the amplifier's input terminals. $C_i$ , along with $R_i$ , create a highpass filter with $f_c = 1/(2\pi R_i C_i)$ . Refer to the section, <b>Selecting Proper External Components</b> , for an explanation of determining the value of $C_i$ .
3. $R_f$	The feedback resistance, along with $R_i$ , set closed-loop gain.
4. $C_S$	This is the supply bypass capacitor. It provides power supply filtering. Refer to the <b>Application Information</b> section for proper placement and selection of the supply bypass capacitor.
5. $C_B$	This is the half-supply bypass pin capacitor. It provides half-supply filtering. Refer to the section, <b>Selecting Proper External Components</b> , for information concerning proper placement and selection of $C_B$ .
6. $C_O$	This is the output coupling capacitor. It blocks the DC voltage at the amplifier's output and forms a high pass filter with $R_L$ at $f_o = 1/(2\pi R_L C_O)$
7. $R_B$	This is the resistor which forms a voltage divider that provides $1/2 V_{DD}$ to the non-inverting input of the amplifier.

## Typical Performance Characteristics

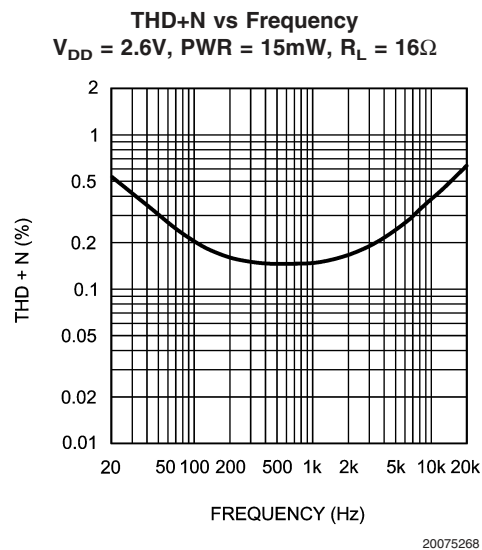
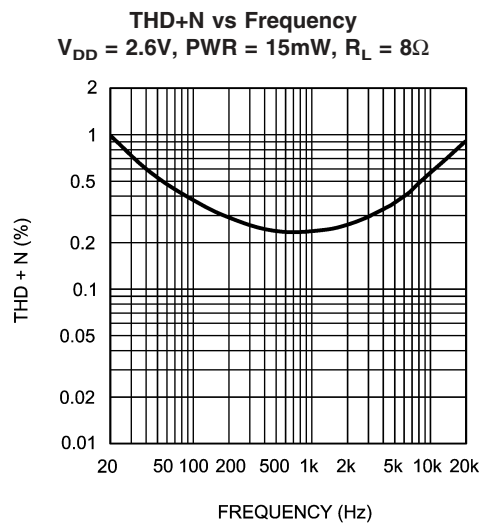

# Typical Performance Characteristics (Continued)

查询"LM4908MM"供应商

### THD+N vs Frequency

$V_{DD} = 2.6V$ , PWR = 15mW,  $R_L = 32\Omega$

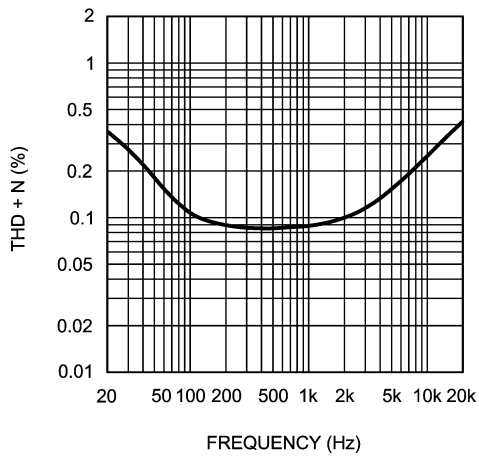

20075269

### THD+N vs Frequency

$V_{DD} = 3.3V$ , PWR = 25mW,  $R_L = 8\Omega$

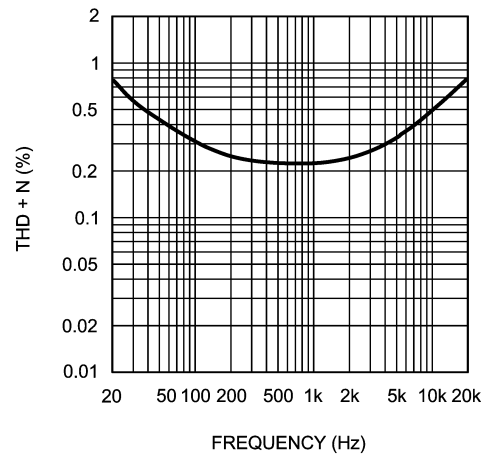

20075270

### THD+N vs Frequency

$V_{DD} = 3.3V$ , PWR = 25mW,  $R_L = 16\Omega$

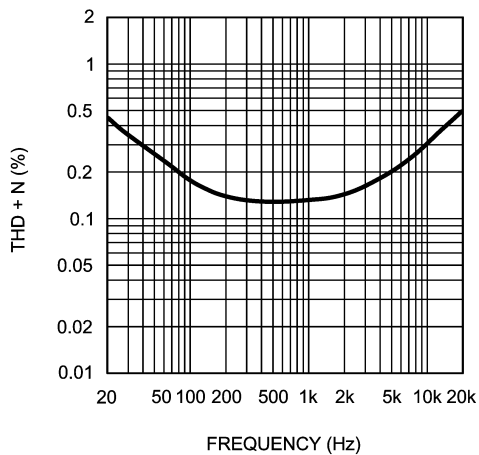

20075271

### THD+N vs Frequency

$V_{DD} = 3.3V$ , PWR = 25mW,  $R_L = 32\Omega$

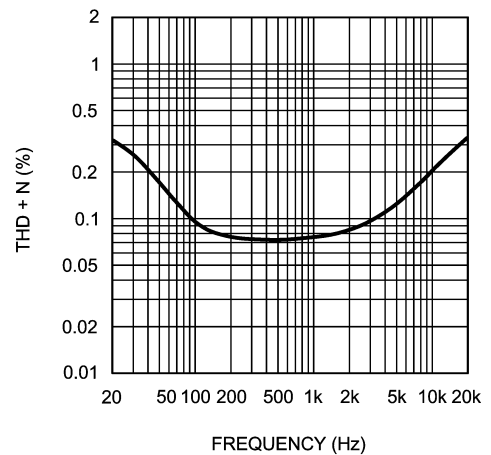

20075272

### THD+N vs Frequency

$V_{DD} = 5V$ , PWR = 50mW,  $R_L = 8\Omega$

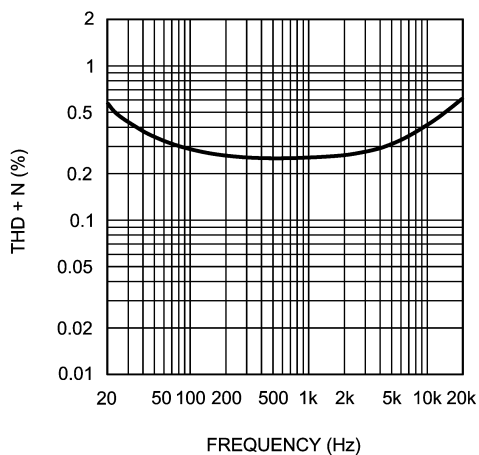

20075273

### THD+N vs Frequency

$V_{DD} = 5V$ , PWR = 50mW,  $R_L = 16\Omega$

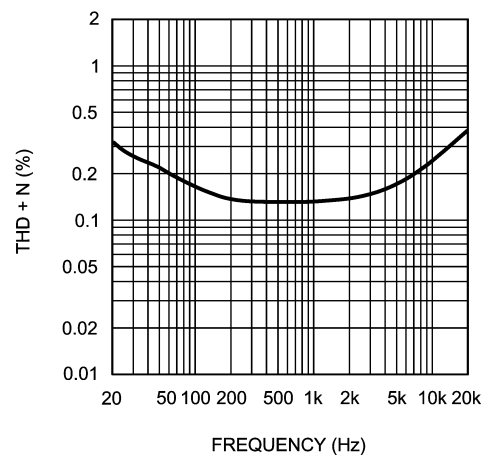

20075274

Typical Performance Characteristics (Continued)

[查询"LM4908MM"供应商](#)

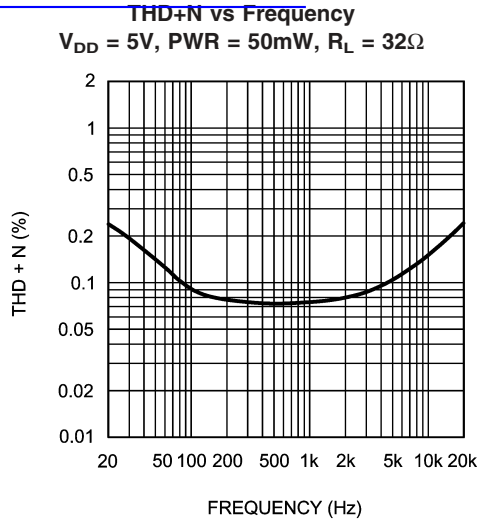

20075275

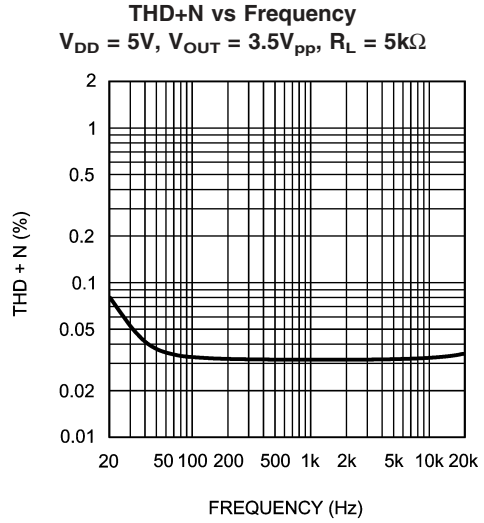

20075276

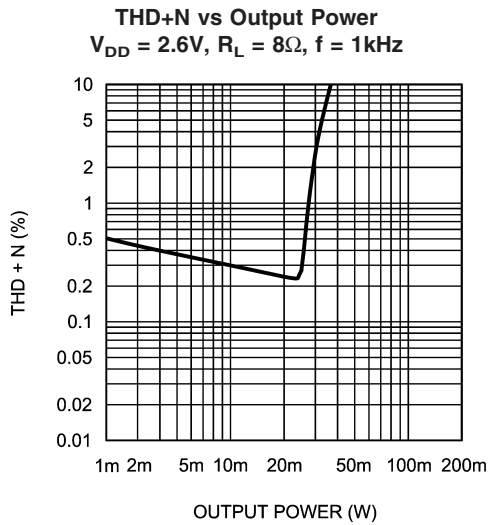

20075277

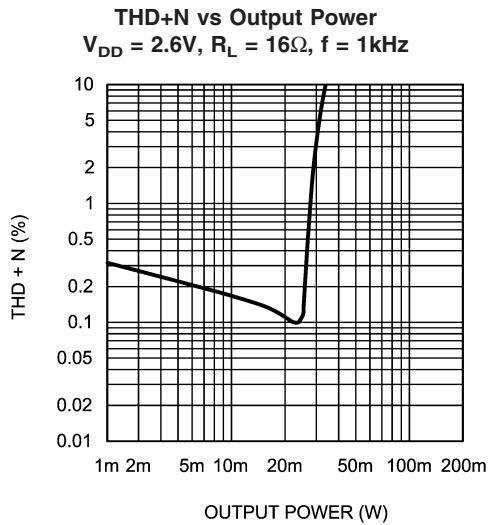

20075278

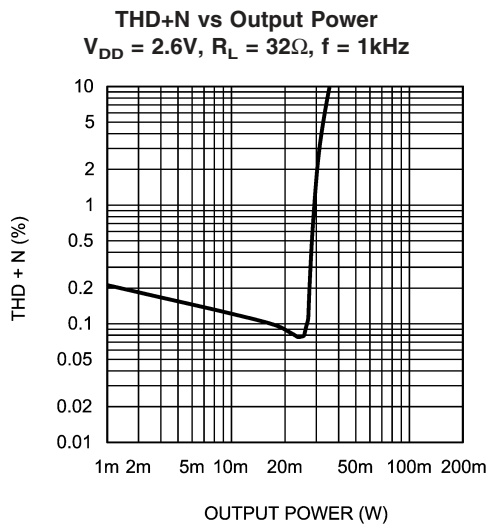

20075279

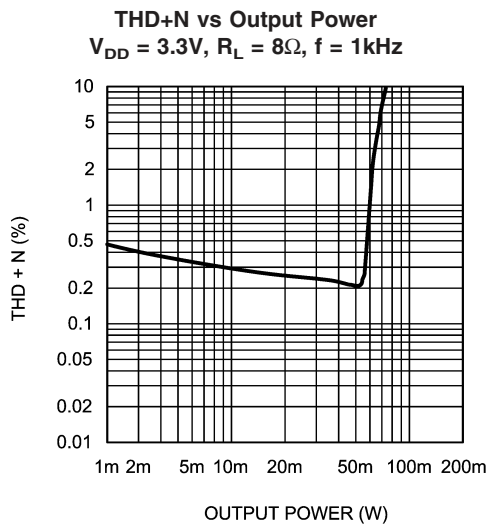

20075280

# Typical Performance Characteristics (Continued)

查询"LM4908MM"供应商

### THD+N vs Output Power

$V_{DD} = 3.3V, R_L = 16\Omega, f = 1kHz$

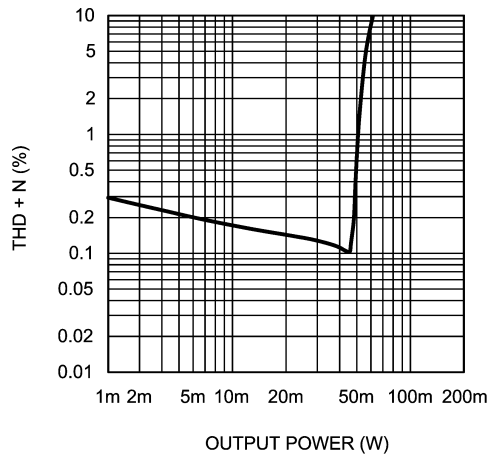

### THD+N vs Output Power

$V_{DD} = 3.3V, R_L = 32\Omega, f = 1kHz$

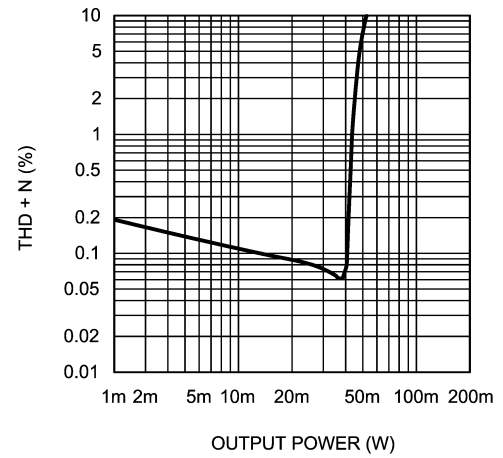

### THD+N vs Output Power

$V_{DD} = 5V, R_L = 8\Omega, f = 1kHz$

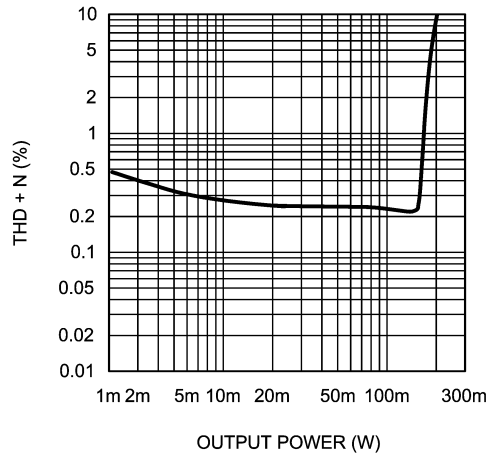

### THD+N vs Output Power

$V_{DD} = 5V, R_L = 16\Omega, f = 1kHz$

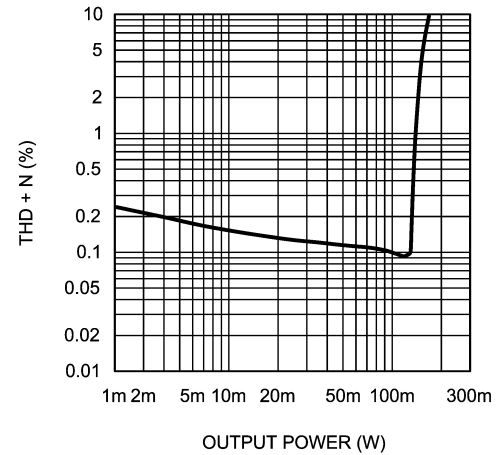

### THD+N vs Output Power

$V_{DD} = 5V, R_L = 32\Omega, f = 1kHz$

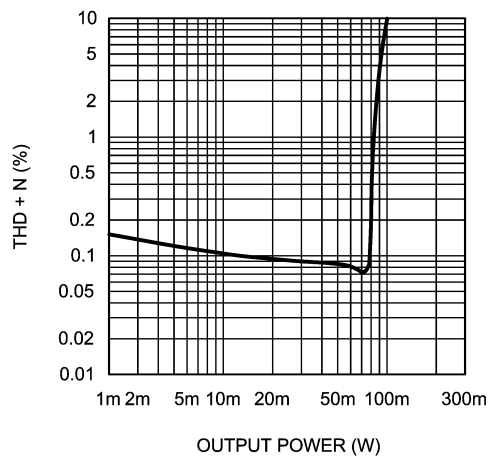

### Output Power vs Load Resistance

$V_{DD} = 2.6V, f = 1kHz$

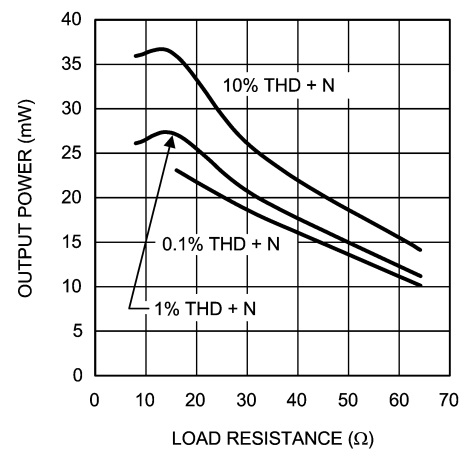



# Typical Performance Characteristics (Continued)

[查询"LM4908MM"供应商](#)

**Output Power vs Load Resistance**

$V_{DD} = 3.3V, f = 1kHz$

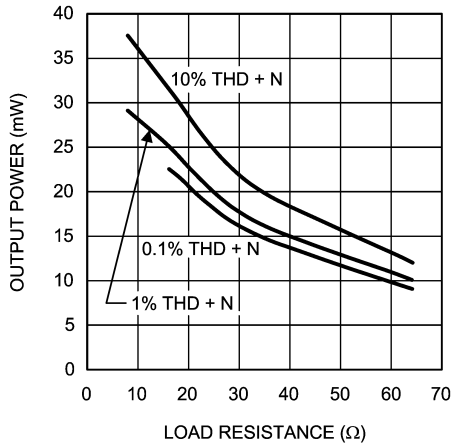

20075287

**Output Power vs Load Resistance**

$V_{DD} = 5V, f = 1kHz$

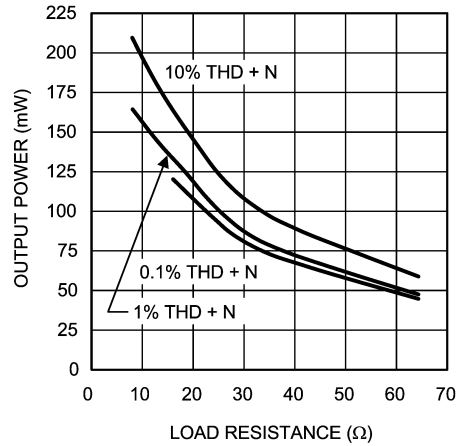

20075288

**Output Power vs Supply Voltage**

$R_L = 8\Omega, f = 1kHz$

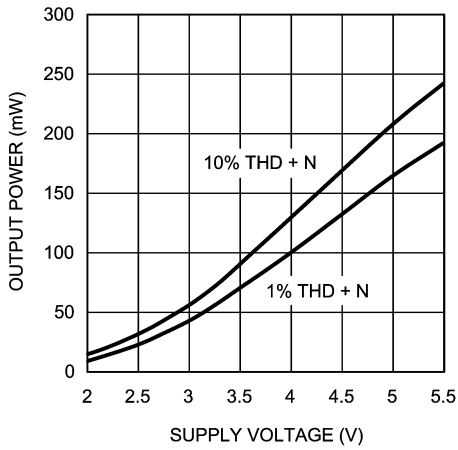

20075289

**Output Power vs Supply Voltage**

$R_L = 16\Omega, f = 1kHz$

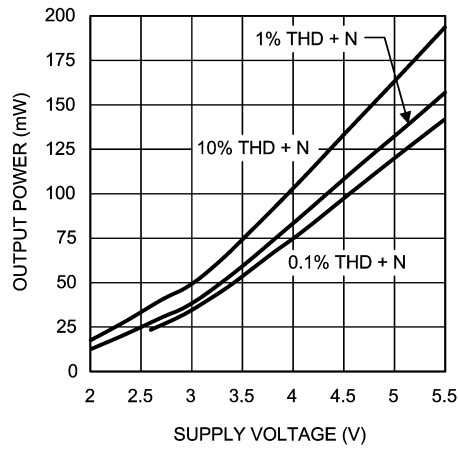

20075290

**Output Power vs Supply Voltage**

$R_L = 32\Omega, f = 1kHz$

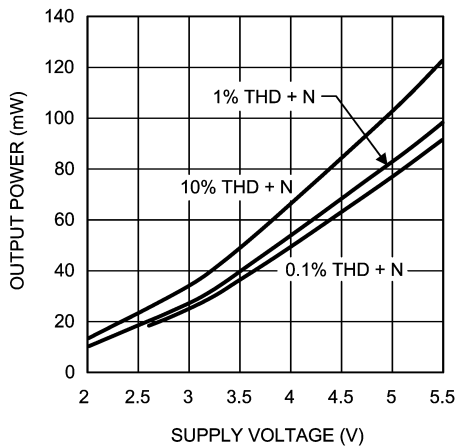

20075291

**Clipping Voltage vs Supply Voltage**

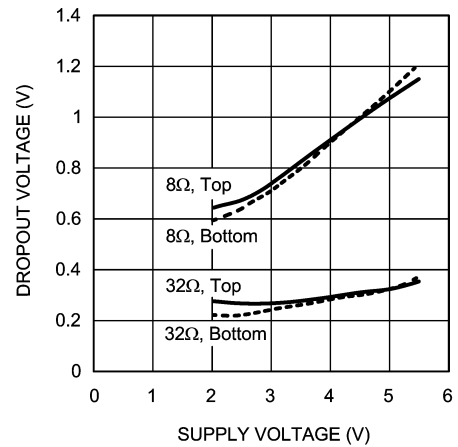

20075292

# Typical Performance Characteristics (Continued)

请向"LM4908MM"供应商

### Power Dissipation vs Output Power

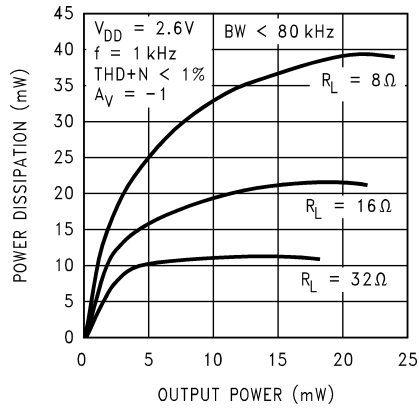

### Power Dissipation vs Output Power

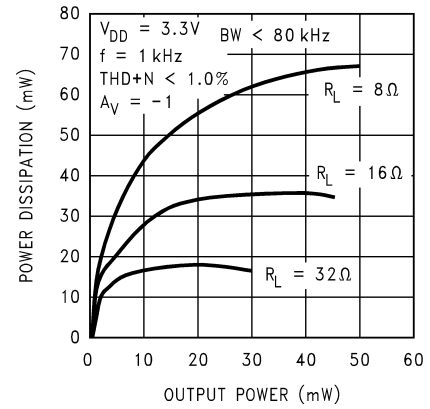

### Power Dissipation vs Output Power

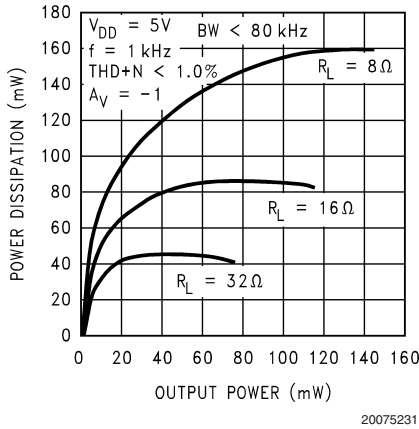

### Crosstalk vs Frequency

$V_{DD} = 5V, R_L = 8\Omega$

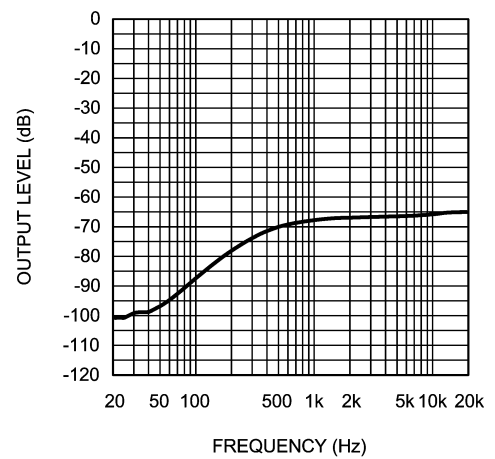

### Crosstalk vs Frequency

$V_{DD} = 5V, R_L = 32\Omega$

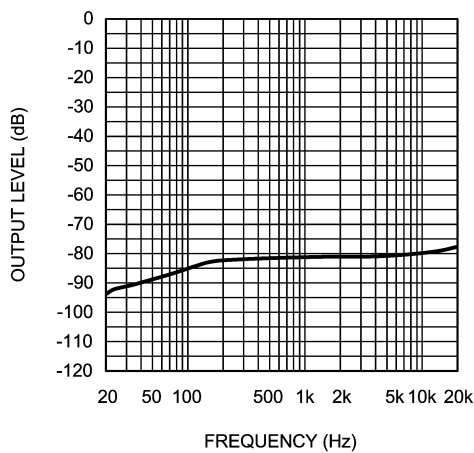

### Output Noise vs Frequency

$V_{DD} = 5V, R_L = 32\Omega$

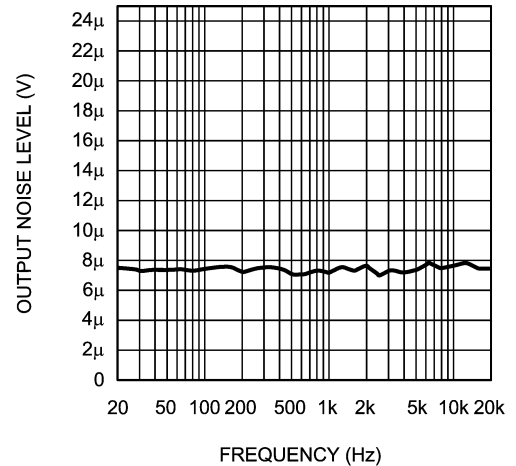

Typical Performance Characteristics (Continued)

[查询"LM4908MM"供应商](#)

**PSRR vs Frequency**  
 $V_{DD} = 5V, R_L = 32\Omega, V_{RIPPLE} = 100mV_{pp}$   
 Pins 3 and 5 directly driven, Inputs Floating

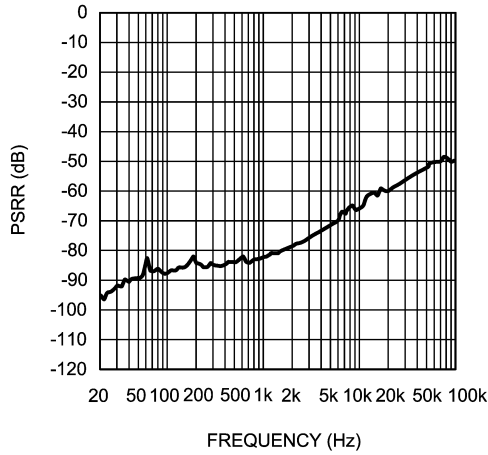

**PSRR vs Frequency**  
 $V_{DD} = 5V, R_L = 32\Omega, V_{RIPPLE} = 100mV_{pp}$   
 Inputs Terminated

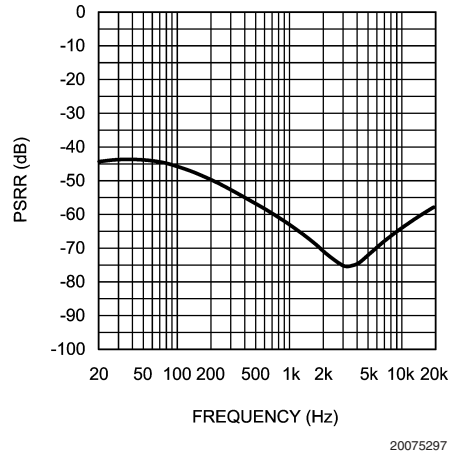

**Open Loop Frequency Response**  
 $V_{DD} = 5V, R_L = 8\Omega$

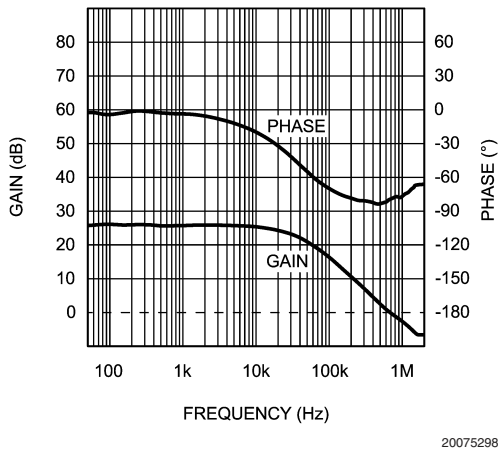

**Open Loop Frequency Response**  
 $V_{DD} = 5V, R_L = 32\Omega$

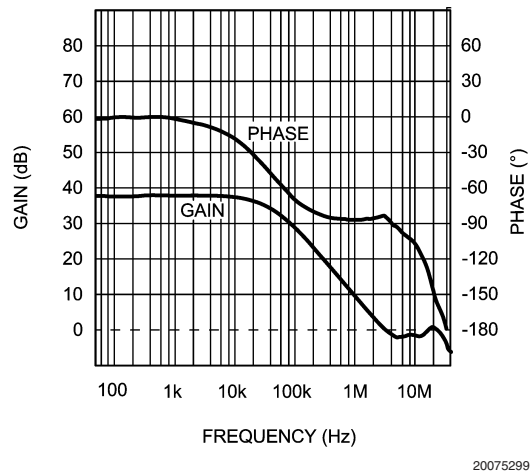

**Open Loop Frequency Response**  
 $V_{DD} = 5V, R_L = 5k\Omega$

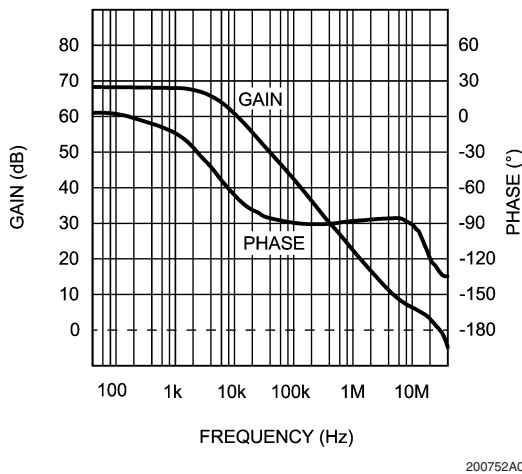

**Supply Current vs Supply Voltage (no Load)**

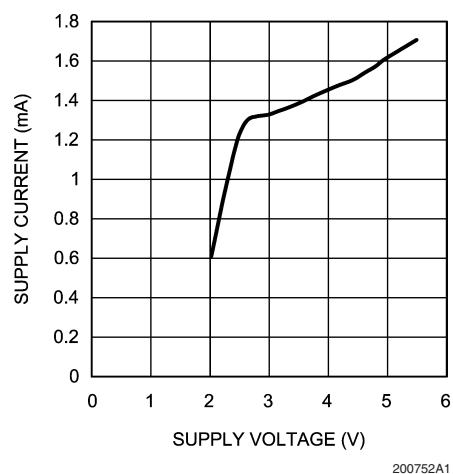

# Typical Performance Characteristics (Continued)

请向"LM4908MM"供应商

### Frequency Response vs Output Capacitor Size

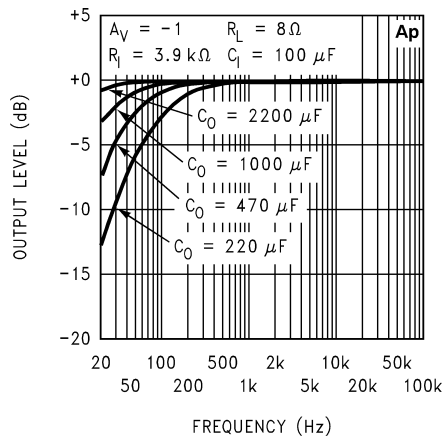

20075245

### Frequency Response vs Output Capacitor Size

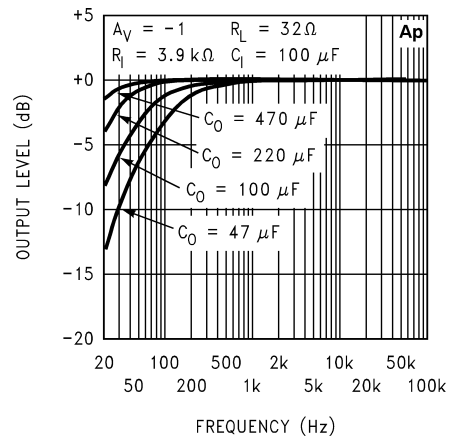

20075246

### Frequency Response vs Output Capacitor Size

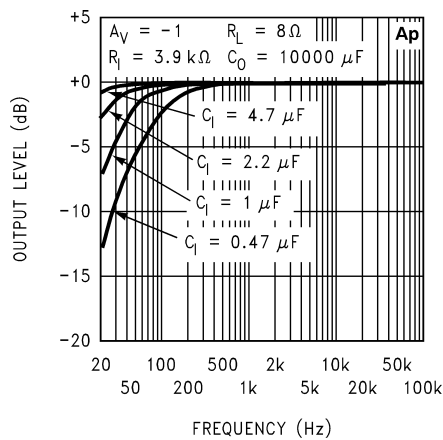

20075247

### Typical Application Frequency Response

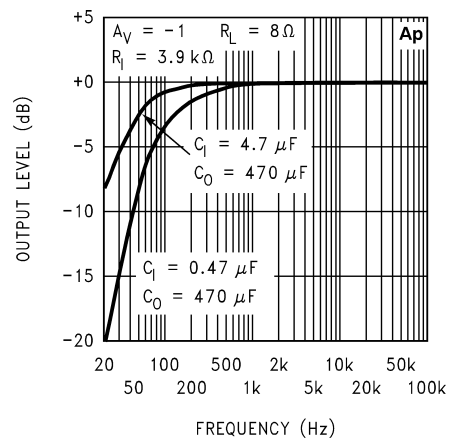

20075248

### Typical Application Frequency Response

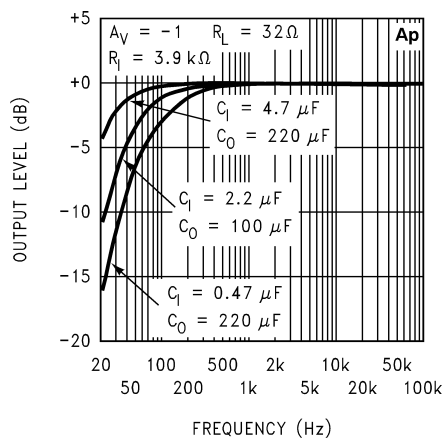

20075249

## Application Information

查询"LM4908MM"供应商

### EXPOSED-DAP PACKAGE PCB MOUNTING CONSIDERATION

The LM4908's exposed-dap (die attach paddle) package (LQ) provides a low thermal resistance between the die and the PCB to which the part is mounted and soldered. This allows rapid heat transfer from the die to the surrounding PCB copper traces, ground plane, and surrounding air.

The LQ package should have its DAP soldered to a copper pad on the PCB. The DAP's PCB copper pad may be connected to a large plane of continuous unbroken copper. This plane forms a thermal mass, heat sink, and radiation area.

However, since the LM4908 is designed for headphone applications, connecting a copper plane to the DAP's PCB copper pad is not required. The LM4908's Power Dissipation vs Output Power Curve in the **Typical Performance Characteristics** shows that the maximum power dissipated is just 45mW per amplifier with a 5V power supply and a 32Ω load.

Further detailed and specific information concerning PCB layout, fabrication, and mounting an LQ (LLP) package is available from National Semiconductor's Package Engineering Group under application note AN1187.

### POWER DISSIPATION

Power dissipation is a major concern when using any power amplifier and must be thoroughly understood to ensure a successful design. Equation 1 states the maximum power dissipation point for a single-ended amplifier operating at a given supply voltage and driving a specified output load.

$$P_{\text{DMAX}} = (V_{\text{DD}})^2 / (2\pi^2 R_L) \quad (1)$$

Since the LM4908 has two operational amplifiers in one package, the maximum internal power dissipation point is twice that of the number which results from Equation 1. Even with the large internal power dissipation, the LM4908 does not require heat sinking over a large range of ambient temperature. From Equation 1, assuming a 5V power supply and a 32Ω load, the maximum power dissipation point is 40mW per amplifier. Thus the maximum package dissipation point is 80mW. The maximum power dissipation point obtained must not be greater than the power dissipation that results from Equation 2:

$$P_{\text{DMAX}} = (T_{\text{JMAX}} - T_A) / \theta_{\text{JA}} \quad (2)$$

For package MUA08A,  $\theta_{\text{JA}} = 210^\circ\text{C/W}$ ,  $T_{\text{JMAX}} = 150^\circ\text{C}$  for the LM4908. Depending on the ambient temperature,  $T_A$ , of the system surroundings, Equation 2 can be used to find the maximum internal power dissipation supported by the IC packaging. If the result of Equation 1 is greater than that of Equation 2, then either the supply voltage must be decreased, the load impedance increased or  $T_A$  reduced. For the typical application of a 5V power supply, with a 32Ω load, the maximum ambient temperature possible without violating the maximum junction temperature is approximately 133.2°C provided that device operation is around the maximum power dissipation point. Power dissipation is a function of output power and thus, if typical operation is not around the maximum power dissipation point, the ambient temperature may be increased accordingly. Refer to the **Typical Performance Characteristics** curves for power dissipation information for lower output powers.

### POWER SUPPLY BYPASSING

As with any power amplifier, proper supply bypassing is critical for low noise performance and high power supply rejection. Applications that employ a 5V regulator typically use a 10μF in parallel with a 0.1μF filter capacitors to stabilize the regulator's output, reduce noise on the supply line, and improve the supply's transient response. However, their presence does not eliminate the need for a local 0.1μF supply bypass capacitor,  $C_S$ , connected between the LM4908's supply pins and ground. Keep the length of leads and traces that connect capacitors between the LM4908's power supply pin and ground as short as possible. Connecting a 1.0μF capacitor,  $C_B$ , between the IN A(+) / IN B(+) node and ground improves the internal bias voltage's stability and improves the amplifier's PSRR. The PSRR improvements increase as the bypass pin capacitor value increases. Too large, however, increases the amplifier's turn-on time. The selection of bypass capacitor values, especially  $C_B$ , depends on desired PSRR requirements, click and pop performance (as explained in the section, **Selecting Proper External Components**), system cost, and size constraints.

### SELECTING PROPER EXTERNAL COMPONENTS

Optimizing the LM4908's performance requires properly selecting external components. Though the LM4908 operates well when using external components with wide tolerances, best performance is achieved by optimizing component values.

The LM4908 is unity-gain stable, giving a designer maximum design flexibility. The gain should be set to no more than a given application requires. This allows the amplifier to achieve minimum THD+N and maximum signal-to-noise ratio. These parameters are compromised as the closed-loop gain increases. However, low gain demands input signals with greater voltage swings to achieve maximum output power. Fortunately, many signal sources such as audio CODECs have outputs of 1V<sub>RMS</sub> (2.83V<sub>P-P</sub>). Please refer to the **Audio Power Amplifier Design** section for more information on selecting the proper gain.

### Input and Output Capacitor Value Selection

Amplifying the lowest audio frequencies requires high value input and output coupling capacitors ( $C_I$  and  $C_O$  in *Figure 1*). A high value capacitor can be expensive and may compromise space efficiency in portable designs. In many cases, however, the speakers used in portable systems, whether internal or external, have little ability to reproduce signals below 150Hz. Applications using speakers with this limited frequency response reap little improvement by using high value input and output capacitors.

Besides affecting system cost and size,  $C_I$  has an effect on the LM4908's click and pop performance. The magnitude of the pop is directly proportional to the input capacitor's size. Thus, pops can be minimized by selecting an input capacitor value that is no higher than necessary to meet the desired -3dB frequency.

As shown in *Figure 1*, the input resistor,  $R_I$  and the input capacitor,  $C_I$ , produce a -3dB high pass filter cutoff frequency that is found using Equation (3). In addition, the output load  $R_L$ , and the output capacitor  $C_O$ , produce a -3dB high pass filter cutoff frequency defined by Equation (4).

$$f_{\text{-3db}} = 1/2\pi R_I C_I \quad (3)$$

$$f_{\text{-3db}} = 1/2\pi R_L C_O \quad (4)$$

## Application Information (Continued)

请向"LM4908MM"供应商

Also, careful consideration must be taken in selecting a certain type of capacitor to be used in the system. Different types of capacitors (tantalum, electrolytic, ceramic) have unique performance characteristics and may affect overall system performance.

### Bypass Capacitor Value

Besides minimizing the input capacitor size, careful consideration should be paid to the value of the bypass capacitor,  $C_B$ . Since  $C_B$  determines how fast the LM4908 settles to quiescent operation, its value is critical when minimizing turn-on pops. The slower the LM4908's outputs ramp to their quiescent DC voltage (nominally  $1/2 V_{DD}$ ), the smaller the turn-on pop. Choosing  $C_B$  equal to  $1.0\mu\text{F}$  or larger, will minimize turn-on pops. As discussed above, choosing  $C_i$  no larger than necessary for the desired bandwidth helps minimize clicks and pops.

## AUDIO POWER AMPLIFIER DESIGN

### Design a Dual 70mW/32Ω Audio Amplifier

Given:

Power Output	70mW
Load Impedance	32Ω
Input Level	1Vrms (max)
Input Impedance	20kΩ
Bandwidth	100Hz–20kHz ± 0.50dB

The design begins by specifying the minimum supply voltage necessary to obtain the specified output power. One way to find the minimum supply voltage is to use the Output Power vs Supply Voltage curve in the **Typical Performance Characteristics** section. Another way, using Equation (5), is to calculate the peak output voltage necessary to achieve the desired output power for a given load impedance. To account for the amplifier's dropout voltage, two additional voltages, based on the Dropout Voltage vs Supply Voltage in the **Typical Performance Characteristics** curves, must be added to the result obtained by Equation (5). For a single-ended application, the result is Equation (6).

$$V_{\text{opeak}} = \sqrt{(2R_L P_O)} \quad (5)$$

$$V_{DD} \geq (2V_{\text{OPEAK}} + (V_{\text{ODTOP}} + V_{\text{ODBOT}})) \quad (6)$$

The Output Power vs Supply Voltage graph for a  $32\Omega$  load indicates a minimum supply voltage of 4.8V. This is easily met by the commonly used 5V supply voltage. The additional voltage creates the benefit of headroom, allowing the LM4908 to produce peak output power in excess of 70mW without clipping or other audible distortion. The choice of supply voltage must also not create a situation that violates maximum power dissipation as explained above in the **Power Dissipation** section. Remember that the maximum power dissipation point from Equation (1) must be multiplied by two since there are two independent amplifiers inside the

package. Once the power dissipation equations have been addressed, the required gain can be determined from Equation (7).

$$A_V \geq \sqrt{(P_O R_L)} / (V_{IN}) = V_{\text{orms}} / V_{\text{inrms}} \quad (7)$$

Thus, a minimum gain of 1.497 allows the LM4908 to reach full output swing and maintain low noise and THD+N performance. For this example, let  $A_V = 1.5$ .

The amplifiers overall gain is set using the input ( $R_i$ ) and feedback ( $R_f$ ) resistors. With the desired input impedance set at  $20\text{k}\Omega$ , the feedback resistor is found using Equation (8).

$$A_V = R_f / R_i \quad (8)$$

The value of  $R_f$  is  $30\text{k}\Omega$ .

The last step in this design is setting the amplifier's  $-3\text{dB}$  frequency bandwidth. To achieve the desired  $\pm 0.25\text{dB}$  pass band magnitude variation limit, the low frequency response must extend to at least one-fifth the lower bandwidth limit and the high frequency response must extend to at least five times the upper bandwidth limit. The gain variation for both response limits is  $0.17\text{dB}$ , well within the  $\pm 0.25\text{dB}$  desired limit. The results are an

$$f_L = 100\text{Hz} / 5 = 20\text{Hz} \quad (9)$$

and a

$$f_H = 20\text{kHz} * 5 = 100\text{kHz} \quad (10)$$

As stated in the **External Components** section, both  $R_i$  in conjunction with  $C_i$ , and  $C_o$  with  $R_L$ , create first order high-pass filters. Thus to obtain the desired low frequency response of  $100\text{Hz}$  within  $\pm 0.5\text{dB}$ , both poles must be taken into consideration. The combination of two single order filters at the same frequency forms a second order response. This results in a signal which is down  $0.34\text{dB}$  at five times away from the single order filter  $-3\text{dB}$  point. Thus, a frequency of  $20\text{Hz}$  is used in the following equations to ensure that the response is better than  $0.5\text{dB}$  down at  $100\text{Hz}$ .

$$C_i \geq 1 / (2\pi * 20 \text{ k}\Omega * 20 \text{ Hz}) = 0.397\mu\text{F}; \text{ use } 0.39\mu\text{F}.$$

$$C_o \geq 1 / (2\pi * 32\Omega * 20 \text{ Hz}) = 249\mu\text{F}; \text{ use } 330\mu\text{F}.$$

The high frequency pole is determined by the product of the desired high frequency pole,  $f_H$ , and the closed-loop gain,  $A_V$ . With a closed-loop gain of 1.5 and  $f_H = 100\text{kHz}$ , the resulting GBWP =  $150\text{kHz}$  which is much smaller than the LM4908's GBWP of  $3\text{MHz}$ . This figure displays that if a designer has a need to design an amplifier with a higher gain, the LM4908 can still be used without running into bandwidth limitations.

# Demonstration Board Layout

[查询"LM4908MM"供应商](#)

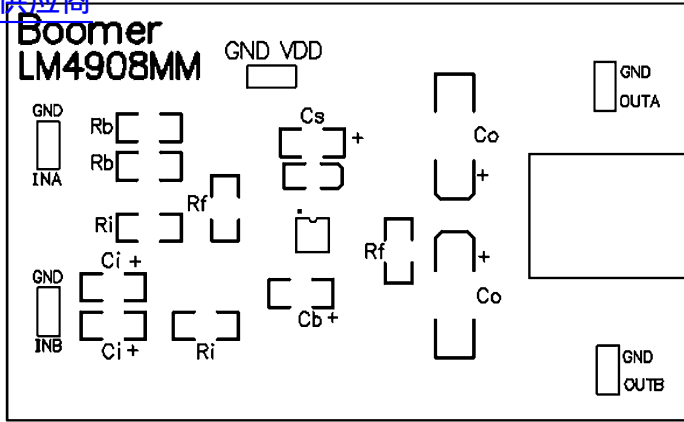

20075264

Recommended MSOP Board Layout:  
Top Overlay

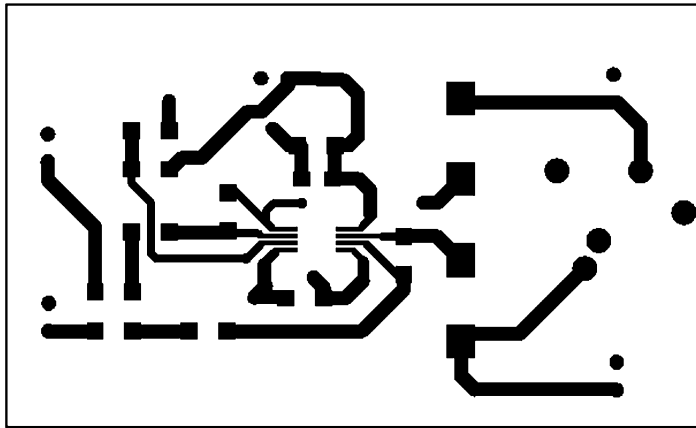

20075265

Recommended MSOP Board Layout:  
Top Layer

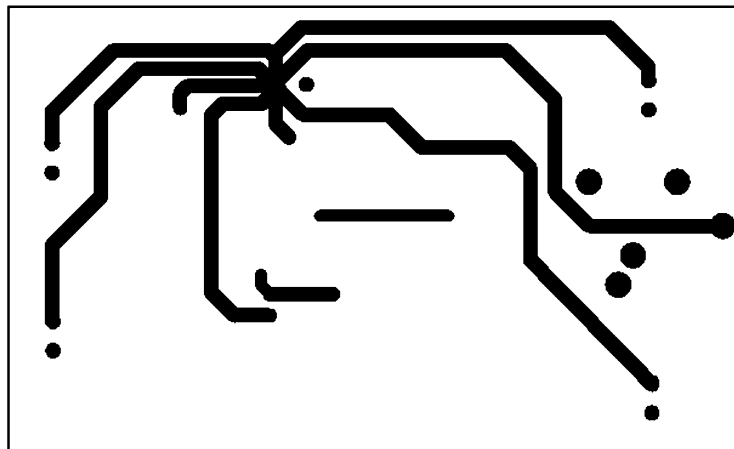

20075266

Recommended MSOP Board Layout:  
Bottom Layer

Demonstration Board Layout (Continued)  
[查询"LM4908MM"供应商](#)

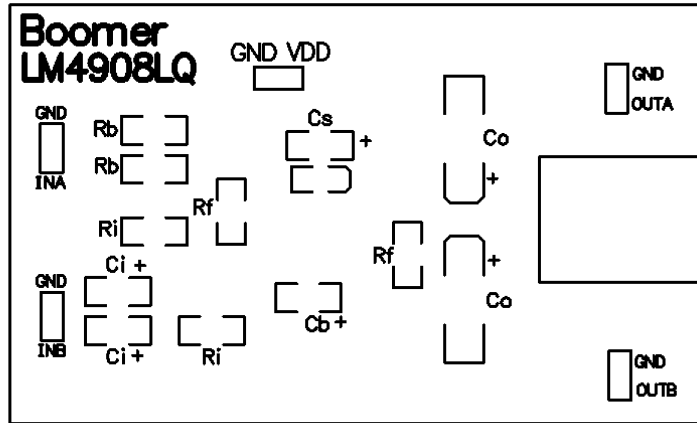

200752B1

Recommended LQ Board Layout:  
Top Overlay

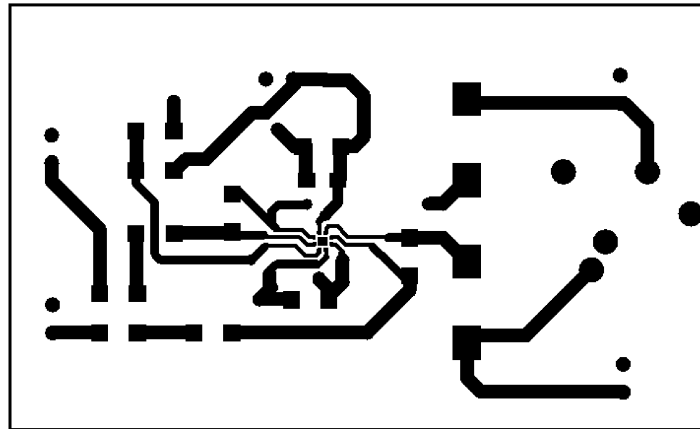

200752B0

Recommended LQ Board Layout:  
Top Layer

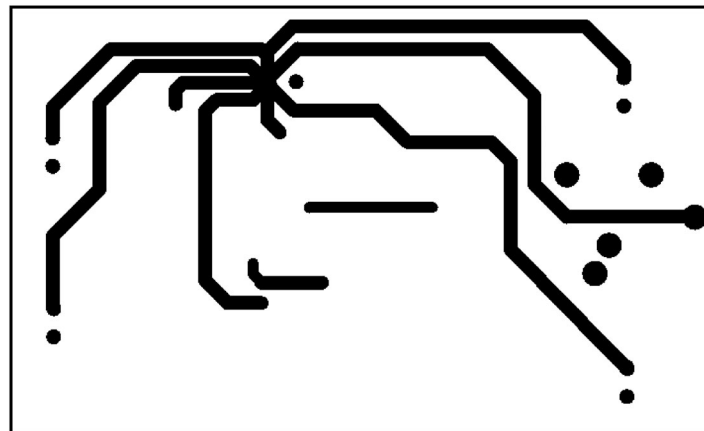

200752A9

Recommended LQ Board Layout:  
Bottom Layer



Demonstration Board Layout (Continued)

[查询"LM4908MM"供应商](#)

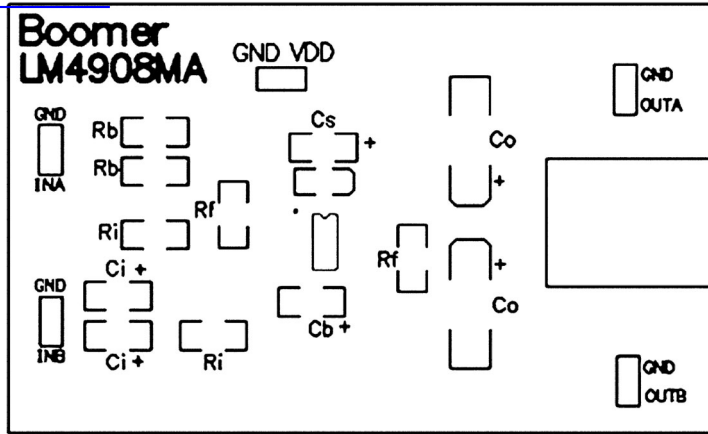

200752B4

Recommended MA Board Layout:  
Top Overlay

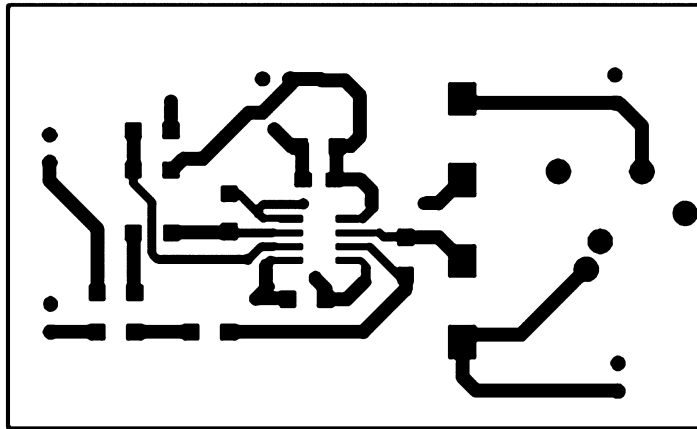

200752B3

Recommended MA Board Layout:  
Top Layer

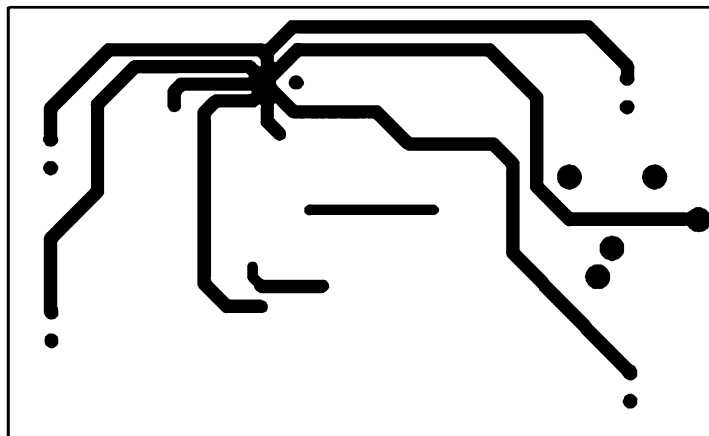

200752B2

Recommended MA Board Layout:  
Bottom Layer

## LM4908 MDC MWC

## Dual 120mW Headphone Amplifier

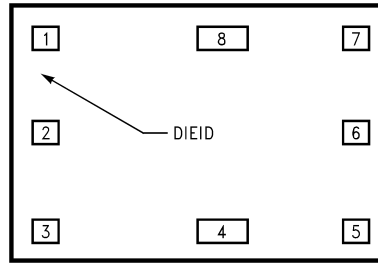

Die Layout (A - Step)

## DIE/WAFER CHARACTERISTICS

Fabrication Attributes		General Die Information	
Physical Die Identification	LM4908A	Bond Pad Opening Size (min)	70 $\mu$ m x 70 $\mu$ m
Die Step	A	Bond Pad Metalization	ALUMINUM
Physical Attributes		Passivation	NITRIDE
Wafer Diameter	150mm	Back Side Metal	BARE BACK
Die Size (Drawn)	889 $\mu$ m x 622 $\mu$ m 35.0mils x 24.5mils	Back Side Connection	Floating
Thickness	216 $\mu$ m Nominal		
Min Pitch	216 $\mu$ m Nominal		

**Special Assembly Requirements:****Note: Actual die size is rounded to the nearest micron.**

## Die Bond Pad Coordinate Locations (A - Step)

(Referenced to die center, coordinates in  $\mu$ m) NC = No Connection, N.U. = Not Used

SIGNAL NAME	PAD# NUMBER	X/Y COORDINATES		PAD SIZE		
		X	Y	X		Y
INPUT B+	1	-367	232	70	x	70
INPUT B-	2	-367	15	70	x	70
OUTPUT B	3	-367	-232	70	x	70
VDD	4	35	-232	155	x	70
OUTPUT A	5	367	-232	70	x	70
INPUT A-	6	367	15	70	x	70
INPUT A+	7	367	232	70	x	70
GND	8	68	232	155	x	70

**LM4908 MDC MWC****Dual 120mW Headphone Amplifier** (Continued)

<b>IN U.S.A</b>	
Tel #:	1 877 Dial Die 1 877 342 5343
Fax:	1 207 541 6140
<b>IN EUROPE</b>	
Tel:	49 (0) 8141 351492 / 1495
Fax:	49 (0) 8141 351470
<b>IN ASIA PACIFIC</b>	
Tel:	(852) 27371701
<b>IN JAPAN</b>	
Tel:	81 043 299 2308

# Physical Dimensions inches (millimeters)

LM4908VW 供应商

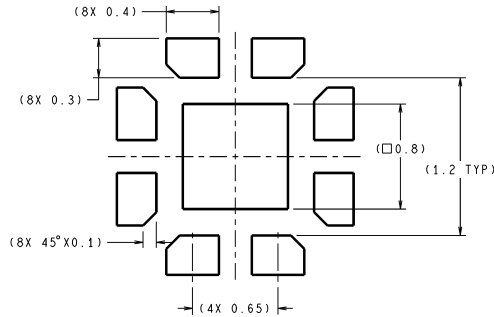

DIMENSIONS ARE IN MILLIMETERS

## RECOMMENDED LAND PATTERN 1:1 RATIO WITH PKG SOLDER PADS

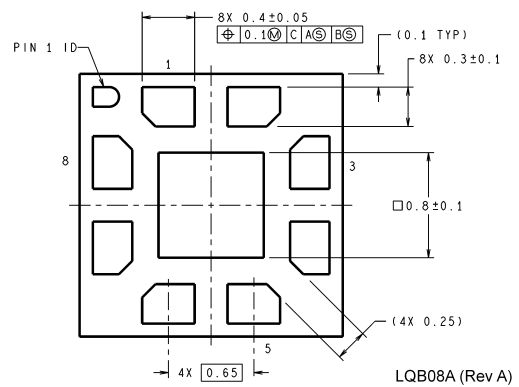
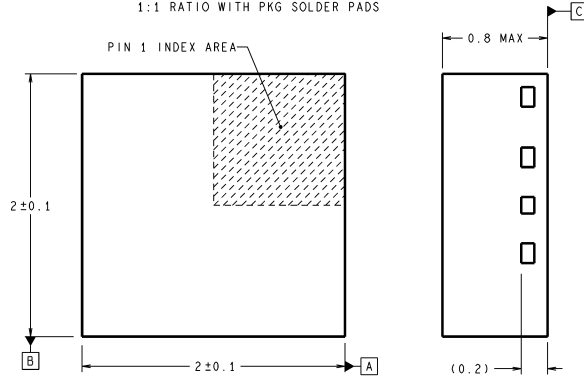

LQB08A (Rev A)

Order Number LM4908LQ  
NS Package Number LQB08A

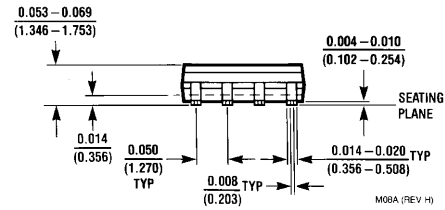
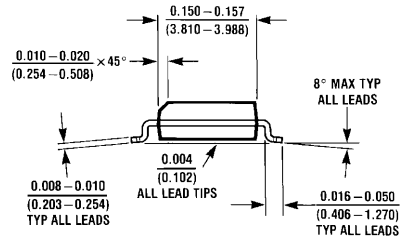
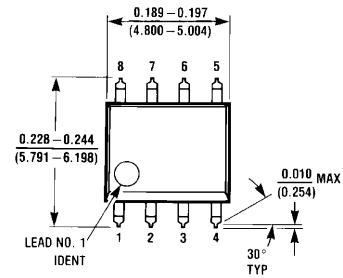

M08A (REV H)

Order Number LM4908MA  
NS Package Number M08A

**Physical Dimensions** inches (millimeters) unless otherwise noted (Continued)

[查询"LM4908MM"供应商](#)

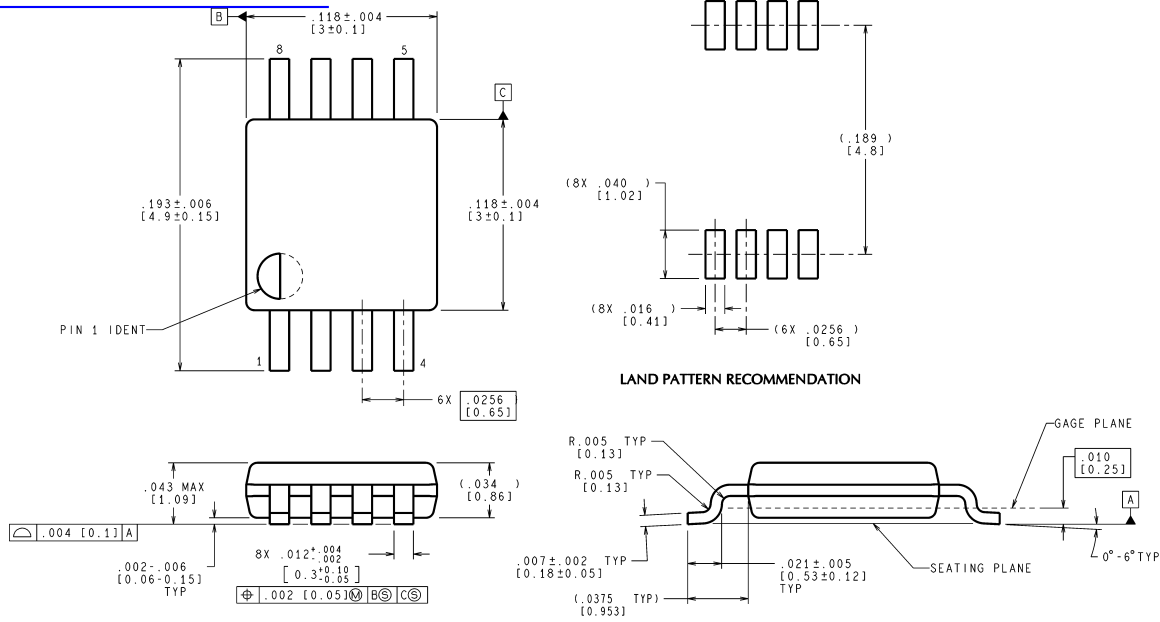

LAND PATTERN RECOMMENDATION

CONTROLLING DIMENSION IS INCH  
VALUES IN [ ] ARE MILLIMETERS

MUA08A (Rev E)

**Order Number LM4908MM**  
**NS Package Number MUA08A**

**LIFE SUPPORT POLICY**

NATIONAL'S PRODUCTS ARE NOT AUTHORIZED FOR USE AS CRITICAL COMPONENTS IN LIFE SUPPORT DEVICES OR SYSTEMS WITHOUT THE EXPRESS WRITTEN APPROVAL OF THE PRESIDENT AND GENERAL COUNSEL OF NATIONAL SEMICONDUCTOR CORPORATION. As used herein:

1. Life support devices or systems are devices or systems which, (a) are intended for surgical implant into the body, or (b) support or sustain life, and whose failure to perform when properly used in accordance with instructions for use provided in the labeling, can be reasonably expected to result in a significant injury to the user.
2. A critical component is any component of a life support device or system whose failure to perform can be reasonably expected to cause the failure of the life support device or system, or to affect its safety or effectiveness.

**BANNED SUBSTANCE COMPLIANCE**

National Semiconductor certifies that the products and packing materials meet the provisions of the Customer Products Stewardship Specification (CSP-9-111C2) and the Banned Substances and Materials of Interest Specification (CSP-9-111S2) and contain no "Banned Substances" as defined in CSP-9-111S2.

**National Semiconductor**  
Americas Customer Support Center  
Email: new.feedback@nsc.com  
Tel: 1-800-272-9959

**National Semiconductor**  
Europe Customer Support Center  
Fax: +49 (0) 180-530 85 86  
Email: europe.support@nsc.com  
Deutsch Tel: +49 (0) 69 9508 6208  
English Tel: +44 (0) 870 24 0 2171  
Français Tel: +33 (0) 1 41 91 8790

**National Semiconductor**  
Asia Pacific Customer Support Center  
Email: ap.support@nsc.com

**National Semiconductor**  
Japan Customer Support Center  
Fax: 81-3-5639-7507  
Email: jpn.feedback@nsc.com  
Tel: 81-3-5639-7560

www.national.com