

# Open Carrier Triple-Balanced Mixer For Microwave Telecommunications

**MC3013**  
V2

## Features

- LO & RF: 2.0 TO 16.0 GHz
- IF: 1.0 TO 8.0 GHz
- LO DRIVE: +13 dBm (NOMINAL)
- MICROSTRIP INTERFACE

## Description

The MC3013 is a triple balanced mixer, designed for use in military, commercial and test equipment applications. The design utilizes Schottky ring quad diodes and broadband soft dielectric baluns to attain excellent performance. The use of high temperature solder and welded assembly processes used internally makes it ideal for use in manual, semi-automated assembly. Environmental screening available to MIL-STD-883, MIL-STD-202 or MIL-DTL-28837, consult factory.

## Product Image

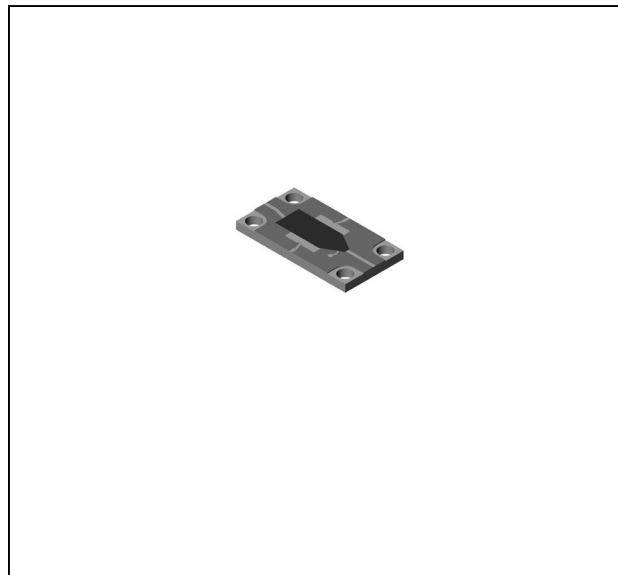

## Ordering Information

Part Number	Package
MC3013	Open Carrier
MC3013-2	Open Carrier

## Electrical Specifications: $Z_0 = 50\Omega$ $Lo = +13$ dBm (Downconverter application only)

Parameter	Test Conditions	Units	Typical	Guaranteed	
				+25°C	-54° to +85°C
SSB Conversion Loss (max) & SSB Noise Figure (max)	$fR = 2$ to 3 GHz, $fL = 2$ to 3 GHz, $fI = 1$ to 8 GHz	dB	10.0	11.5	12.0
	$fR = 3$ to 10 GHz, $fL = 3$ to 10 GHz, $fI = 1$ to 8 GHz	dB	7.0	9.0	9.5
	$fR = 10$ to 16 GHz, $fL = 10$ to 16 GHz, $fI = 1$ to 8 GHz	dB	8.0	11.0	11.5
Isolation, L to R (min)	$fL = 2$ to 12 GHz	dB	20	15	13
	$fL = 12$ to 16 GHz	dB	17	12	10
Isolation, L to I (min)	$fL = 2$ to 4 GHz	dB	21	15	13
	$fL = 4$ to 16 GHz	dB	25	18	16
Isolation, R to I (min)	$fL = 2$ to 16 GHz	dB	25		
1 dB Conversion Comp.	$fL = +13$ dBm	dBm	+7		
Input IP3	$fR1 = 8$ GHz at -3 dBm, $fR2 = 8.01$ GHz at -3 dBm, $fL = 10$ GHz at +13 dBm	dBm	+17		
	$fR1 = 11$ GHz at -3 dBm, $fR2 = 11.01$ GHz at -3 dBm, $fL = 16$ GHz at +13 dBm	dBm	+17		
	$fR1 = 6$ GHz at -3 dBm, $fR2 = 6.01$ GHz at -3 dBm, $fL = 14$ GHz at +13 dBm	dBm	+17		

**Open Carrier Triple-Balanced Mixer  
For Microwave Telecommunications**

**MC3013**  
V2

**Typical Performance Curves**

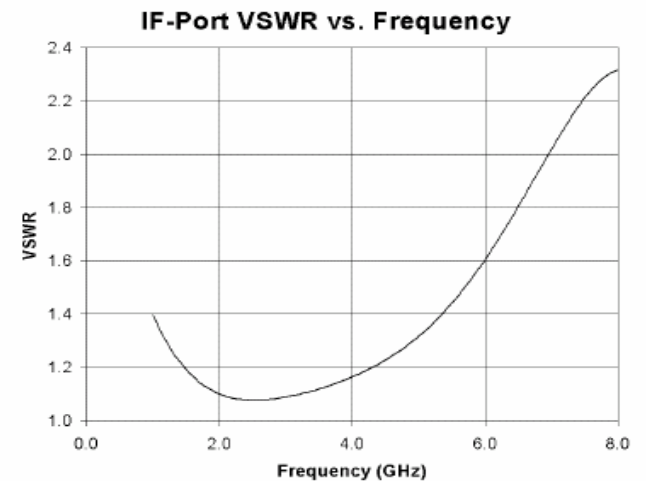
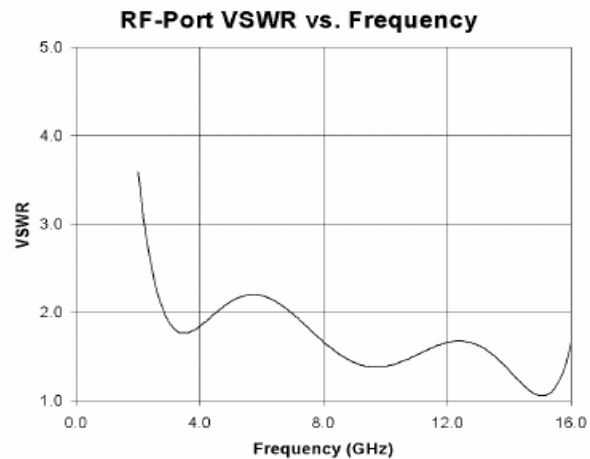
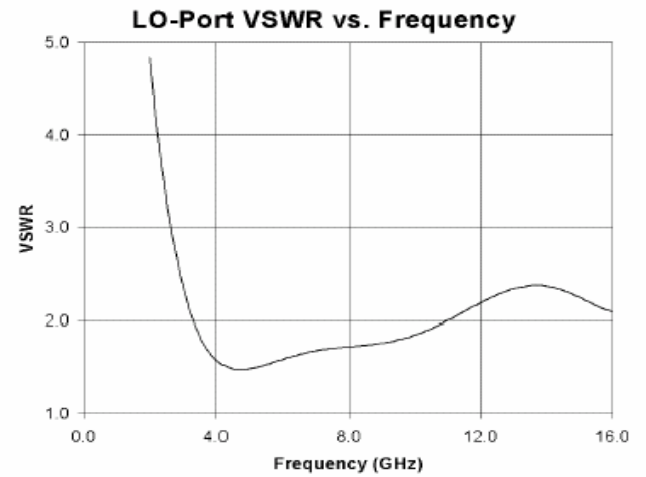
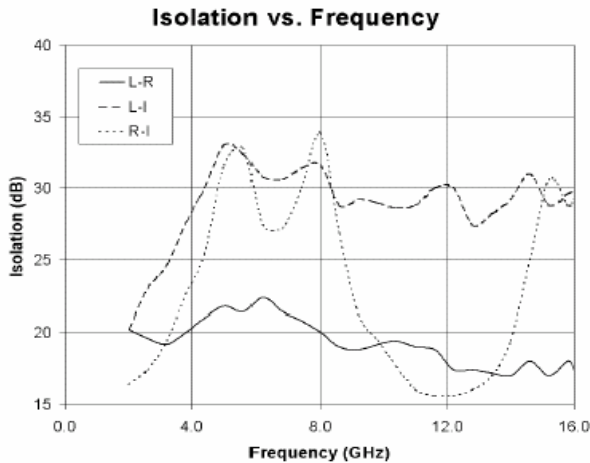
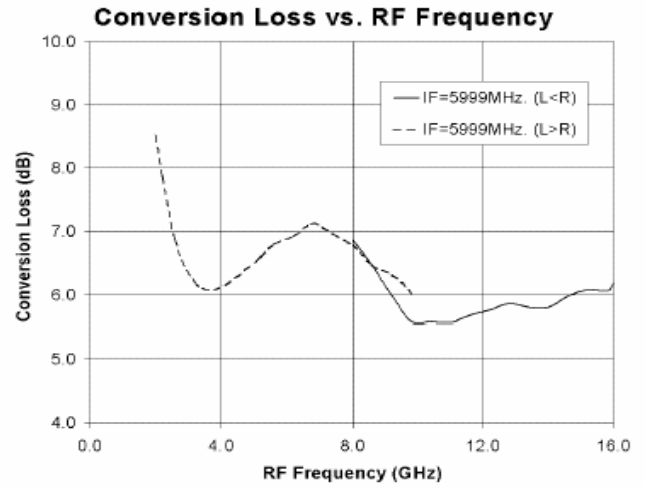
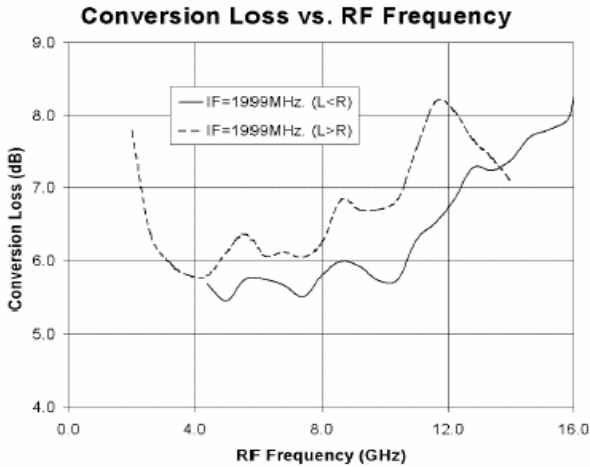

**Open Carrier Triple-Balanced Mixer  
For Microwave Telecommunications**

**MC3013**  
V2

**Absolute Maximum Ratings**

Parameter	Absolute Maximum
Operating Temperature	-54°C to +85°C
Storage Temperature	-65°C to +100°C
Peak Input Power	+23 dBm max @ +25°C +20 dBm max @ +85°C
Peak Input Current	50 mA DC

**Outline Drawing: Open Carrier\* MC3013**

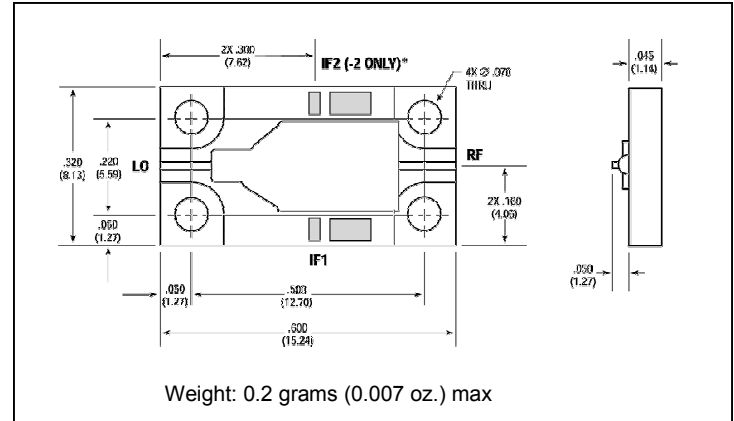

\*For base model, only IF1 port is connected.  
For the "-2" model, only the IF2 port is connected.

\* Dimensions are inches (millimeters) ±0.015 (0.38) unless otherwise specified.