

type RMG residual current devices

10/30/100/300mA
100/300mA time delayed

BS EN61008 商

716 8172 to 716 8378

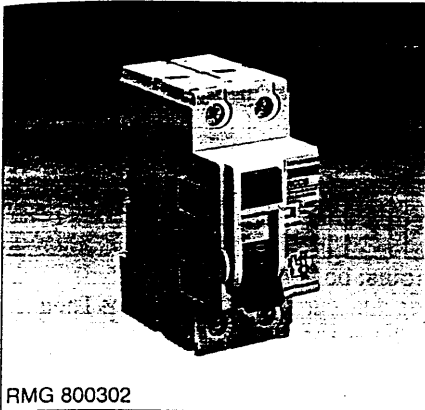

RMG 800302

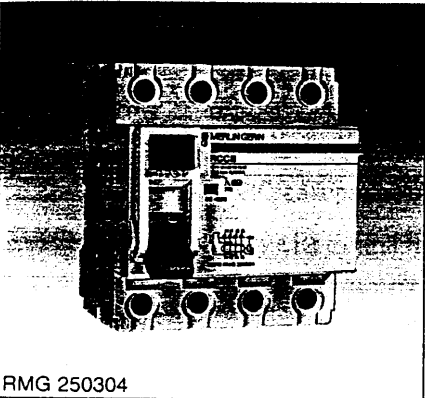

RMG 250304

application

Type RMG residual current devices provide the functions of isolation, switching and earth leakage protection of electrical circuits.

They have a residual current operated electro-mechanical release which operates without any auxiliary source of supply to open a circuit automatically in the case of an earth leakage fault between phase and earth greater than or equal to a threshold of 10, 30, 100 or 300mA.

■ RMG rcd: time-delayed versions part n°. 23111 (80A 100mA two pole)

Provides discrimination with downstream 10mA and 30mA sensitivity instantaneous residual current devices.

part n°. 23116 (100A 300mA two pole) Provides discrimination with downstream 30mA and 100mA sensitivity instantaneous residual current devices.

part n°. 23146 (63A 300mA four pole) provides discrimination with downstream 30mA and 100mA sensitivity instantaneous residual current devices

Specifications

■ rcd: BS EN61008: 1983 or CEE 27

Technical data

■ positive contact indication in accordance with the 16th edition of the IEE Wiring Regulations (537-02-04, 536-03) BS7671.

unwanted tripping

All RMG rcds incorporate a filtering device preventing the risks of unwanted tripping due to transient voltages (lightning, line disturbances on other equipment...) and transient currents (from high capacitive circuits.)

Class A devices: consult us

Electrical data

■ current ratings: 16A to 100A

■ voltage ratings:

2 pole: 110/240V AC

4 pole: 240/415V AC

■ sensitivities (non-adjustable)

300mA for all current ratings (except 16A & 25A, 2P)

300mA time-delayed, 100A 2P & 63A 4P
100mA in 63A/80A/100A 2P & 63A 4P current ratings.

100mA time delayed 80A 2P only.

30mA for all current ratings (except 16A)

10mA in 2P 16A and 25A current ratings.

■ cable capacities

16A-80A: tunnel terminals for cables up to 35mm²

100A: clamp terminals for cables up to 50mm²

3 phase 3 wire 415V applications

(no neutral present)

Auxiliary test resistor required (installed externally as indicated)

30mA	2400Ω	4 watt
100mA	820Ω	4 watt
300 mA	270Ω	4 watt

■ number of operating cycles: (on load) 20,000 cycles (O-C).

■ operating temperature: -5 to +40°C

■ Identification system

ALL RMG rcd's can accept up to a total of 4 marking accessories on each of their poles.

The following symbols are available: Blank, 1-9, +, -, and A-Z.

Note: 100A 2 pole type RMG rcds are NOT suitable for use as incomers to ISO-BAR SP&N distribution boards.

■ width in 9mm modules

2P RMG all ratings: 4

4P RMG all ratings: 8

Installation

■ on symmetrical DIN rail

■ panel mounting

Note: RMG residual current devices must be used with circuit breakers to provide circuit protection of overload and short circuit faults

■ dimensions: see page 126

type RMG rcd - two pole

rating (A)	sensitivity (mA)	part n°.
16	10	RMG 16 010 2
	30	RMG 16 030 2
	300	RMG 16 300 2
25	10	RMG 25 010 2
	30	RMG 25 030 2
	300	RMG 25 300 2
40	30	RMG 40 030 2
	300	RMG 40 300 2
	63	30
63	100	RMG 63 100 2
	300	RMG 63 300 2
80	30	RMG 80 030 2
	100	RMG 80 100 2
	300	RMG 80 300 2
100	30	RMG 100 030 2
	100	RMG 100 100 2
	300	RMG 100 300 2
80	100	
time delayed		23111 (50-70mS)
100	300	
time delayed		23116 (50-70mS)

type RMG rcd - four pole

rating (A)	sensitivity (mA)	part n°.
25	30	RMG 25 030 4
	300	RMG 25 300 4
40	30	RMG 40 030 4
	300	RMG 40 300 4
63	30	RMG 63 030 4
	100	RMG 63 100 4
	300	RMG 63 300 4
63	300	
time delayed		23146 50-70mS

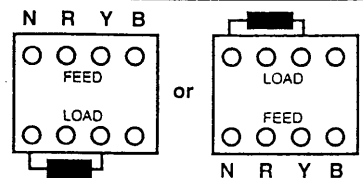

electrical auxiliaries for 2P and 4P RMG type residual current devices

[查询"26923"供应商](#)

Only for 63A and above

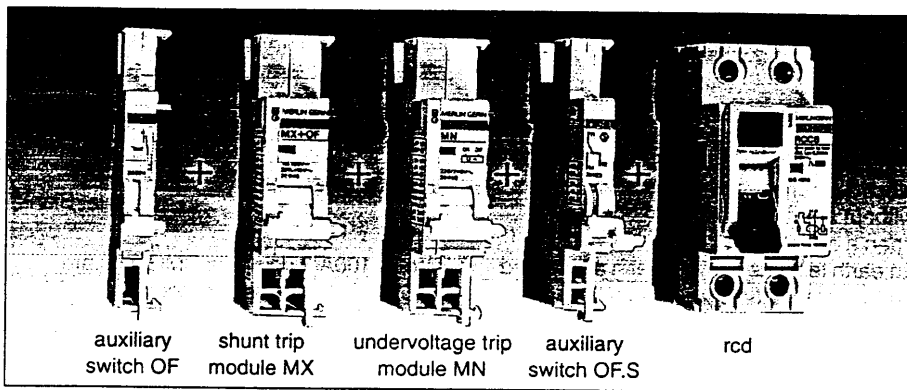

auxiliary switch OF shunt trip module MX undervoltage trip module MN auxiliary switch OFS rcd

Arrangement of auxiliaries

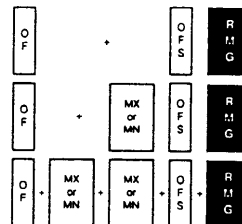

notes: both 2P and 4P RMG type residual current devices can be fitted with the above combinations of electrical auxiliaries.

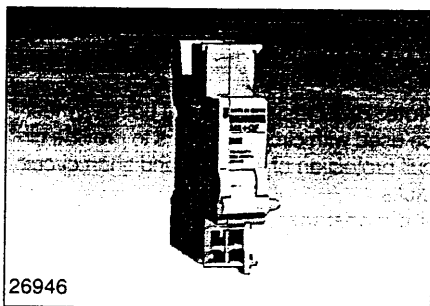

26946

shunt trip release (MX)

- enables remote tripping
- is equipped with a cut-off switch in series with the coil
- includes one auxiliary changeover switch (OF)
- red flag trip indicator
- mounted on the LHS of the OFS
- cable capacity 2.5mm².

N° of SP ways	9mm mod.	coil volt	consumption pickup W or VA	part n°.
1	2	130DC	10	26946
1	2	240AC	50	26946
1	2	415AC	120	26946
1	2	48-60DC	22	26947
1	2	48-130AC	200	26947
1	2	24AC/DC	120	26948

(also requires OFS 26923)

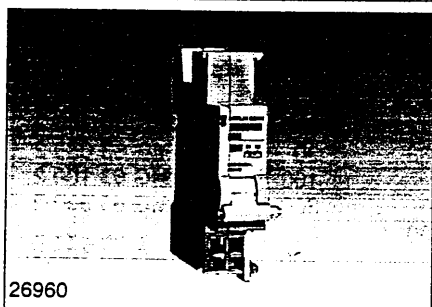

26960

undervoltage release (MN)

- enables the rcd to be tripped either when the auxiliary supply voltage drops or by the opening operation of a normally closed remote pushbutton
- prevents the rcd from being switched 'ON' again if the undervoltage release supply is not present
- red flag trip indicator
- mounted on the LHS of the OFS
- cable capacity 2.5mm².

N° of SP ways	9mm mod.	coil volt	consumption hold W or VA	part n°.
1	2	220/240AC	4.1	26960
1	2	48AC	4.3	26961
1	2	48DC	2	26962

(also requires OFS 26923)

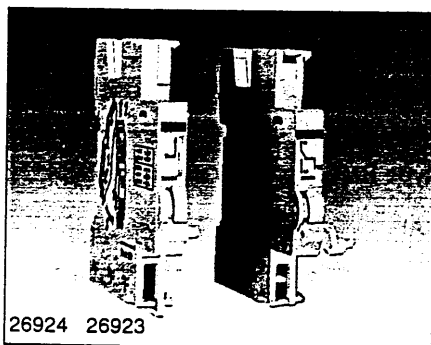

26924 26923

auxiliary switch (OFS/OF)

- a changeover switch which acts as an indicating or control device to monitor the ON or OFF positions of an rcd
- the OFS also acts as an adaptor mounted on the LHS of rcd, between the rcd and any other auxiliaries (additional OF, MX, MN, mounted on LHS of OFS)
- test function
- cable capacity 2.5mm²

No. of SP ways	9mm modules		part n°.
1/2	1	OFS	26923
1/2	1	OF	26924

contact ratings (A):

- 3A at 415V AC ■ 6A at 240V AC
- 1A at 125V DC ■ 2A at 48V DC
- 6A at 24V DC

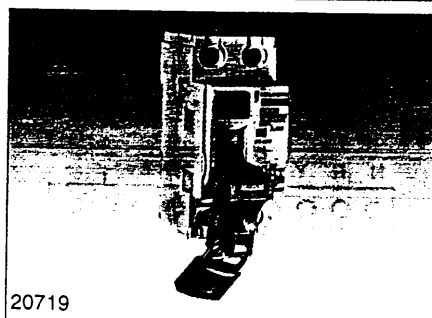

20719

padlocking attachment

- padlocks in the 'ON' or 'OFF' position

	part n°.
padlock attachment	20719

accessories and enclosures for RMG residual current devices

查询"26923" 供应商

- ▼ metal
- ❖ all-insulated

accessories

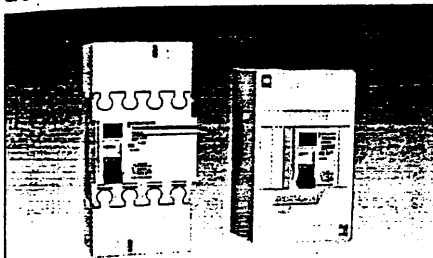

RMG 253004 + 26978 RMG 630302 + 13312

- terminal shields
 - two-piece: completely covers terminals (cannot be fitted to 100A 2 pole unit)
 - one-piece: completely covers terminals
- padlocking attachment (not shown)
- padlock (not shown)
- dimensions see page 130

	part n°.
Two piece unit for use with 2P RMG rcds (except 100A unit)	26976
Two piece unit for use with 4P RMG rcds	26978
One piece unit for use with 2P RMG rcds (IP30 enclosure)	13312
One piece unit for use with 4P RMG rcds (IP30 enclosure)	13314
Padlocking attachment	20719
Padlock with 2 keys	MGPL
Spare key for MGPL	MGPLSK

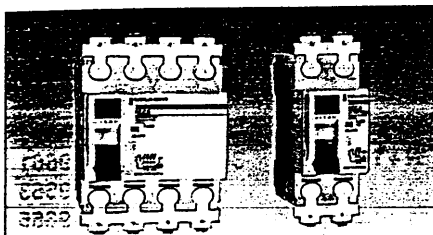

RMG 253004 + 26981 RMG 800302 + 26981

- sealable terminal screw shield
- Enables total isolation of the terminal screws. 2P and 4P RMG rcds only.

	part n°.
for use with 2P and 4P RMG rcds (bag of 8 shields)	26981

enclosures (see page 113 for full range)

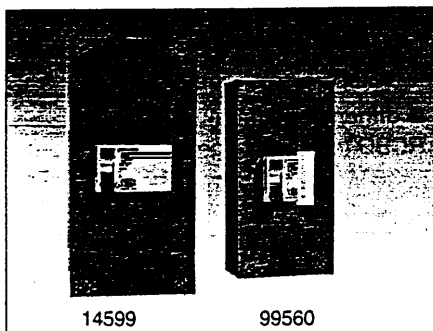

14599 99560

- ▼ G9 enclosure IP30
- Made from folded steel, epoxy powder coated.
- Degree of protection: IP30.**
- It consists of:
- a back plate with DIN rail
 - a cover screwed to the back plate having 25mm knockouts top and bottom.
- dimensions see page 130
- For 4P RMG rcds use 14599
For 2P RMG rcds use 99560

capacity (poles)	9mm modules	part n°.
4	8	14599
5	11	14603
2*-3	4-6*	99560

*blanking plate supplied

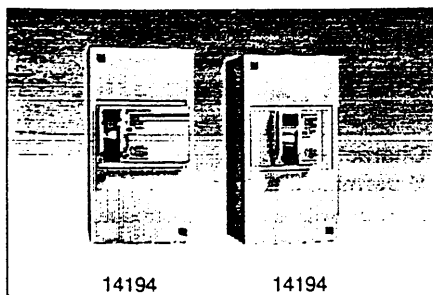

14194 14194

- ❖ D9 enclosure IP30
- Impact resistant, all-insulated enclosure self extinguishing to 650°C.
- Degree of protection: IP30.**
- It consists of:
- an insulated back plate with integral DIN-rail
 - a cover screwed to the back plate
 - four-hole terminal bar (also available separately - (poles) part n°. 14901).

capacity (poles)	9mm modules	part n°.
2-3*-4*	4-6*-8*	14194

* aperture with knockouts to suit increased number of modules

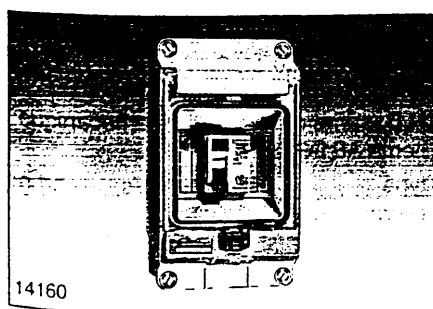

14160

- ❖ EK9 enclosure IP55
- EK9 weatherproof enclosures are all-insulated and made of a high impact resistant thermoplastic material which is self-extinguishing.
- Degree of protection: IP55**

capacity (poles)	9mm modules	part n°.
1-4	2-8	14160
4-8	8-16	14161
8-12	16-24	14162

- dimensions see page 130

- They consist of:
- a symmetrical mounting rail with two height settings
 - cable entry from the top or bottom
 - screwed cover with hinged transparent window
 - optional terminal rails which simply clip into position - see page 110

dimensions

[查询"26923"供应商](#)

enclosures
Mini Opale
G9
A Series
EK9

Mini Opale enclosures

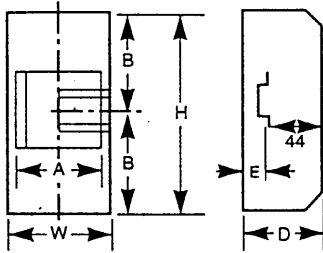

dimensions (mm)

Part no.	H	W	D	A	B	E
13312	130	44	57	36	65	11
13314	130	80	57	72	65	11
13316	160	119	65	108	80	19
13318	160	155	65	151	80	19

G9 enclosures

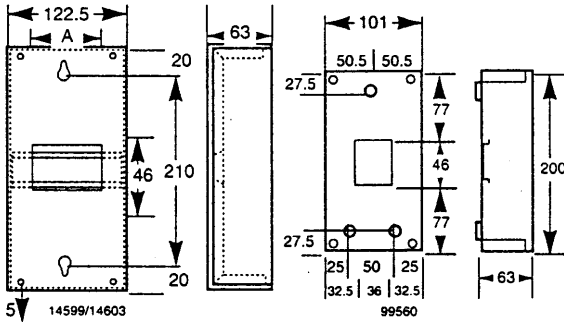

dimensions (mm)

Part no.	A
14599	72
14603	99

A-series enclosures

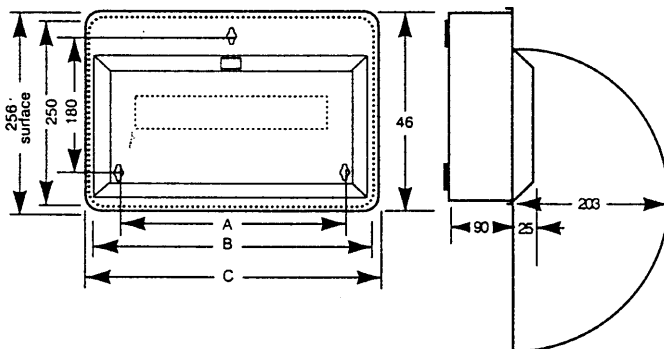

dimensions (mm)

Part no.	A	B	C
MGSA16	190	260	266
MGSA22	245	315	321
MGSA28	300	370	376
MGSA34	350	420	426
MGSA56*			

*For dimensions of MGSA56 enclosure see MGA24 enclosure diagram on page 122.

EK9

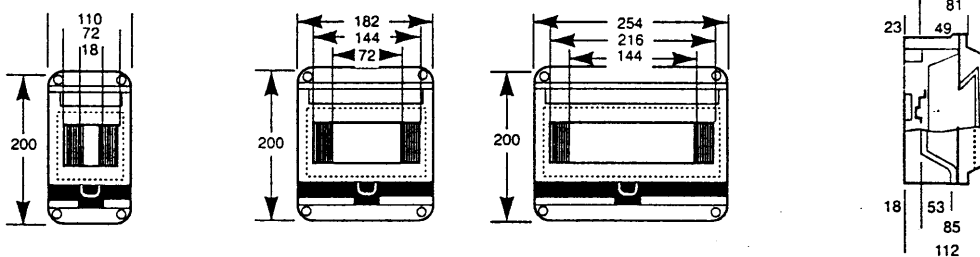

enclosure mounting holes

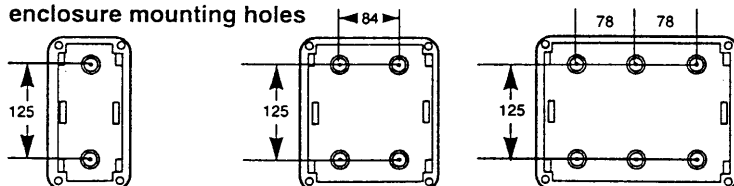

mounting using wall lugs: 3 possible positions for each enclosure

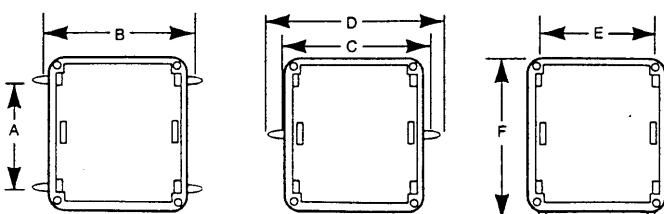

Number of modules

	A	B	C	D	E	F
4	159	137	126	149	81	215
8	159	209	198	281	153	215
12	159	281	270	293	225	215

[查询"26923"供应商](#)

Opale distribution enclosures

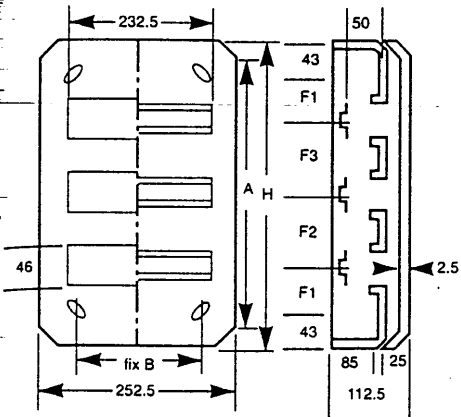

dimensions (mm)

Part no.	H	A	B	F1	F2	F3
13401 (1 row)	225	143	183.5	69		
13402 (2 rows)	350	272	174	69	125	
13403 (3 rows)	475	397	174	69	125	125

P25M enclosures

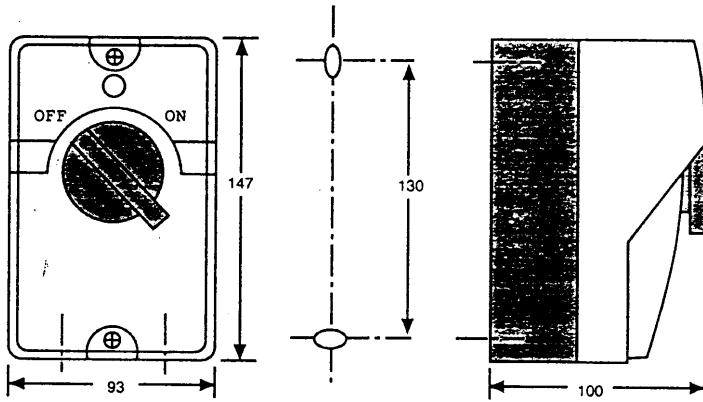

UP

dimensions (mm)	H	L	P	J	K	A	I	F	G	C
Part no.										
02504/02514	400	300	200	375	150	325	225	380	260	137
02505/02515	500	400	200	475	250	425	325	480	360	112
02506/02516	600	400	250	575	250	525	325	580	360	170
02507/02517	700	500	300	675	350	625	425	680	460	145
02508/02518	800	600	300	775	450	725	525	780	560	195

