

MC10E166, MC100E166

5V ECL 9-Bit Magnitude Comparator

Description

The MC10E/100E166 is a 9-bit magnitude comparator which compares the binary value of two 9-bit words and indicates whether one word is greater than, or equal to, the other.

The 100 Series contains temperature compensation.

Features

- 1100 ps Max. $\overline{A} = \overline{B}$
 - PECL Mode Operating Range: $V_{CC} = 4.2\text{ V to } 5.5\text{ V}$
with $V_{EE} = 0\text{ V}$
 - NECL Mode Operating Range: $V_{CC} = 0\text{ V}$
with $V_{EE} = -4.2\text{ V to } -5.5\text{ V}$
 - Internal Input 50 k Ω Pulldown Resistors
 - ESD Protection: Human Body Model; > 2 kV,
Machine Model; > 200 V
 - Meets or Exceeds JEDEC Spec EIA/JESD78 IC Latchup Test
 - Moisture Sensitivity Level:
Pb = 1
Pb-Free = 3
- For Additional Information, see Application Note AND8003/D
- Flammability Rating: UL 94 V-0 @ 1.125 in,
Oxygen Index: 28 to 34
 - Transistor Count = 354 devices
 - Pb-Free Packages are Available*



ON Semiconductor®

<http://onsemi.com>

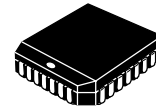

PLCC-28
FN SUFFIX
CASE 776

MARKING DIAGRAM*

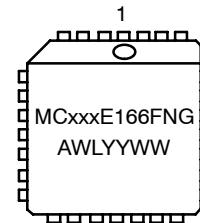

xxx = 10 or 100
A = Assembly Location
WL = Wafer Lot
YY = Year
WW = Work Week
G = Pb-Free Package

*For additional marking information, refer to Application Note AND8002/D.

ORDERING INFORMATION

See detailed ordering and shipping information in the package dimensions section on page 5 of this data sheet.

*For additional information on our Pb-Free strategy and soldering details, please download the ON Semiconductor Soldering and Mounting Techniques Reference Manual, SOLDERRM/D.

MC10E166, MC100E166

查询"MC10E166FNR2"供应商

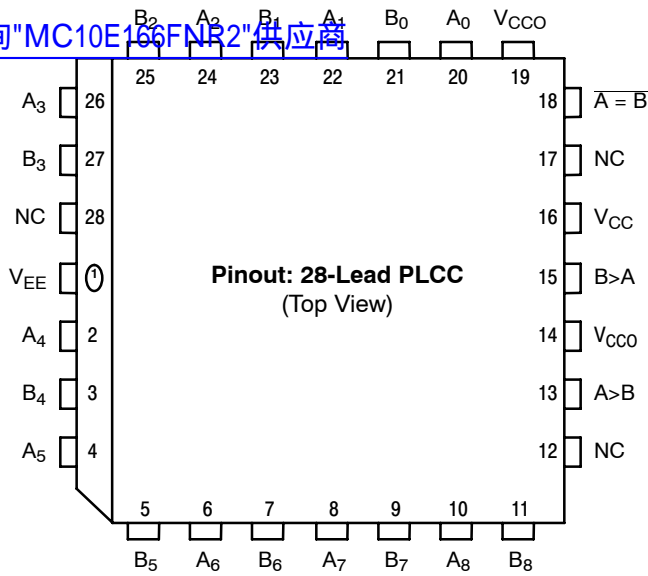

* All V_{CC} and V_{CCO} pins are tied together on the die.

Warning: All V_{CC} , V_{CCO} , and V_{EE} pins must be externally connected to Power Supply to guarantee proper operation.

Figure 1. 28-Lead Pinout Assignment

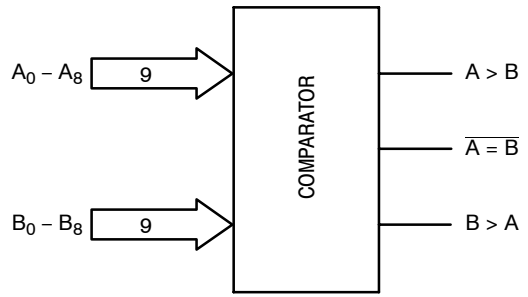

Figure 2. Logic Diagram

Table 1. PIN DESCRIPTION

PIN	FUNCTION
$A_0 - A_8$	ECL A Data Inputs
$B_0 - B_8$	ECL B Data Inputs
$A > B$	ECL A Greater than B Output
$B > A$	ECL B Greater than A Output
$\overline{A = B}$	ECL A Equal to B Output (active-LOW)
V_{CC}, V_{CCO}	Positive Supply
V_{EE}	Negative Supply
NC	No Connect

MC10E166, MC100E166

Table 2. MAXIMUM RATINGS

Symbol	Parameter	Condition 1	Condition 2	Rating	Unit
V _{CC}	PECL Mode Power Supply	V _{EE} = 0 V		8	V
V _I	PECL Mode Input Voltage	V _{EE} = 0 V	V _I ≤ V _{CC}	6	V
	NECL Mode Input Voltage	V _{CC} = 0 V	V _I ≥ V _{EE}	-6	V
I _{out}	Output Current	Continuous Surge		50	mA
				100	mA
T _A	Operating Temperature Range			0 to +85	°C
T _{stg}	Storage Temperature Range			-65 to +150	°C
θ _{JA}	Thermal Resistance (Junction-to-Ambient)	0 lfp	PLCC-28	63.5	°C/W
		500 lfp	PLCC-28	43.5	°C/W
θ _{JC}	Thermal Resistance (Junction-to-Case)	Standard Board	PLCC-28	22 to 26	°C/W
T _{sol}	Wave Solder	Pb Pb-Free		265	°C
				265	°C

Stresses exceeding Maximum Ratings may damage the device. Maximum Ratings are stress ratings only. Functional operation above the Recommended Operating Conditions is not implied. Extended exposure to stresses above the Recommended Operating Conditions may affect device reliability.

Table 3. 10E SERIES PECL DC CHARACTERISTICS V_{CCx} = 5.0 V, V_{EE} = 0.0 V (Note 1)

Symbol	Characteristic	0°C			25°C			85°C			Unit
		Min	Typ	Max	Min	Typ	Max	Min	Typ	Max	
I _{EE}	Power Supply Current		113	156		113	156		113	156	mA
V _{OH}	Output HIGH Voltage (Note 2)	3980	4070	4160	4020	4105	4190	4090	4185	4280	mV
V _{OL}	Output LOW Voltage (Note 2)	3050	3210	3370	3050	3210	3370	3050	3227	3405	mV
V _{IH}	Input HIGH Voltage	3830	3995	4160	3870	4030	4190	3940	4110	4280	mV
V _{IL}	Input LOW Voltage	3050	3285	3520	3050	3285	3520	3050	3302	3555	mV
I _{IH}	Input HIGH Current			150			150			150	μA
I _{IL}	Input LOW Current	0.5	0.3		0.5	0.25		0.3	0.2		μA

NOTE: Device will meet the specifications after thermal equilibrium has been established when mounted in a test socket or printed circuit board with maintained transverse airflow greater than 500 lfp. Electrical parameters are guaranteed only over the declared operating temperature range. Functional operation of the device exceeding these conditions is not implied. Device specification limit values are applied individually under normal operating conditions and not valid simultaneously.

1. Input and output parameters vary 1:1 with V_{CC}. V_{EE} can vary -0.46 V / +0.06 V.
2. Outputs are terminated through a 50 Ω resistor to V_{CC} - 2.0 V.

Table 4. 10E SERIES NECL DC CHARACTERISTICS V_{CCx} = 0.0 V; V_{EE} = -5.0 V (Note 3)

Symbol	Characteristic	0°C			25°C			85°C			Unit
		Min	Typ	Max	Min	Typ	Max	Min	Typ	Max	
I _{EE}	Power Supply Current		113	156		113	156		113	156	mA
V _{OH}	Output HIGH Voltage (Note 4)	-1020	-930	-840	-980	-895	-810	-910	-815	-720	mV
V _{OL}	Output LOW Voltage (Note 4)	-1950	-1790	-1630	-1950	-1790	-1630	-1950	-1773	-1595	mV
V _{IH}	Input HIGH Voltage	-1170	-1005	-840	-1130	-970	-810	-1060	-890	-720	mV
V _{IL}	Input LOW Voltage	-1950	-1715	-1480	-1950	-1715	-1480	-1950	-1698	-1445	mV
I _{IH}	Input HIGH Current			150			150			150	μA
I _{IL}	Input LOW Current	0.5	0.3		0.5	0.065		0.3	0.2		μA

NOTE: Device will meet the specifications after thermal equilibrium has been established when mounted in a test socket or printed circuit board with maintained transverse airflow greater than 500 lfp. Electrical parameters are guaranteed only over the declared operating temperature range. Functional operation of the device exceeding these conditions is not implied. Device specification limit values are applied individually under normal operating conditions and not valid simultaneously.

3. Input and output parameters vary 1:1 with V_{CC}. V_{EE} can vary -0.46 V / +0.06 V.
4. Outputs are terminated through a 50 Ω resistor to V_{CC} - 2.0 V.

MC10E166, MC100E166

Table 5. 100E SERIES NECL DC CHARACTERISTICS $V_{CCx} = 5.0 \text{ V}$; $V_{EE} = 0.0 \text{ V}$ (Note 5)

Symbol	Characteristic	0°C			25°C			85°C			Unit
		Min	Typ	Max	Min	Typ	Max	Min	Typ	Max	
I_{EE}	Power Supply Current		113	156		113	156		130	156	mA
V_{OH}	Output HIGH Voltage (Note 6)	3975	4050	4120	3975	4050	4120	3975	4050	4120	mV
V_{OL}	Output LOW Voltage (Note 6)	3190	3295	3380	3190	3255	3380	3190	3260	3380	mV
V_{IH}	Input HIGH Voltage	3835	3975	4120	3835	3975	4120	3835	3975	4120	mV
V_{IL}	Input LOW Voltage	3190	3355	3525	3190	3355	3525	3190	3355	3525	mV
I_{IH}	Input HIGH Current			150			150			150	μA
I_{IL}	Input LOW Current	0.5	0.3		0.5	0.25		0.5	0.2		μA

NOTE: Device will meet the specifications after thermal equilibrium has been established when mounted in a test socket or printed circuit board with maintained transverse airflow greater than 500 lfm. Electrical parameters are guaranteed only over the declared operating temperature range. Functional operation of the device exceeding these conditions is not implied. Device specification limit values are applied individually under normal operating conditions and not valid simultaneously.

5. Input and output parameters vary 1:1 with V_{CC} . V_{EE} can vary $-0.46 \text{ V} / +0.8 \text{ V}$.

6. Outputs are terminated through a 50Ω resistor to $V_{CC} - 2.0 \text{ V}$.

Table 6. 100E SERIES NECL DC CHARACTERISTICS $V_{CCx} = 0 \text{ V}$; $V_{EE} = -5.0 \text{ V}$ (Note 7)

Symbol	Characteristic	0°C			25°C			85°C			Unit
		Min	Typ	Max	Min	Typ	Max	Min	Typ	Max	
I_{EE}	Power Supply Current		33	40		33	40		38	46	mA
I_{EE}	Power Supply Current		113	156		113	156		130	156	mA
V_{OH}	Output HIGH Voltage (Note 8)	-1025	-950	-880	-1025	-950	-880	-1025	-950	-880	mV
V_{OL}	Output LOW Voltage (Note 8)	-1810	-1705	-1620	-1810	-1745	-1620	-1810	-1740	-1620	mV
V_{IH}	Input HIGH Voltage	-1165	-1025	-880	-1165	-1025	-880	-1165	-1025	-880	mV
V_{IL}	Input LOW Voltage	-1810	-1645	-1475	-1810	-1645	-1475	-1810	-1645	-1475	mV
I_{IH}	Input HIGH Current			150			150			150	μA
I_{IL}	Input LOW Current	0.5	0.3		0.5	0.25		0.5	0.2		μA

NOTE: Device will meet the specifications after thermal equilibrium has been established when mounted in a test socket or printed circuit board with maintained transverse airflow greater than 500 lfm. Electrical parameters are guaranteed only over the declared operating temperature range. Functional operation of the device exceeding these conditions is not implied. Device specification limit values are applied individually under normal operating conditions and not valid simultaneously.

7. Input and output parameters vary 1:1 with V_{CC} . V_{EE} can vary $-0.46 \text{ V} / +0.8 \text{ V}$.

8. Outputs are terminated through a 50Ω resistor to $V_{CC} - 2.0 \text{ V}$.

Table 7. AC CHARACTERISTICS $V_{CCx} = 5.0 \text{ V}$; $V_{EE} = 0.0 \text{ V}$ or $V_{CCx} = 0.0 \text{ V}$; $V_{EE} = -5.0 \text{ V}$ (Note 9)

Symbol	Characteristic	0°C			25°C			85°C			Unit
		Min	Typ	Max	Min	Typ	Max	Min	Typ	Max	
f_{MAX}	Maximum Toggle Frequency	1100			1100			1100			MHz
t_{PLH} t_{PHL}	Propagation Delay to Output D to $\overline{A} = B$ D to $A < B, A > B$	500	750	1100	500	750	1100	500	750	1100	ps
t_{JITTER}	Random Clock Jitter (RMS)		< 1			< 1			< 1		ps
t_r t_f	Rise/Fall Time (20 - 80%)	300	450	800	300	450	800	300	450	800	ps

NOTE: Device will meet the specifications after thermal equilibrium has been established when mounted in a test socket or printed circuit board with maintained transverse airflow greater than 500 lfm. Electrical parameters are guaranteed only over the declared operating temperature range. Functional operation of the device exceeding these conditions is not implied. Device specification limit values are applied individually under normal operating conditions and not valid simultaneously.

9. 10 Series: V_{EE} can vary $-0.46 \text{ V} / +0.06 \text{ V}$.

100 Series: V_{EE} can vary $-0.46 \text{ V} / +0.8 \text{ V}$.

MC10E166, MC100E166

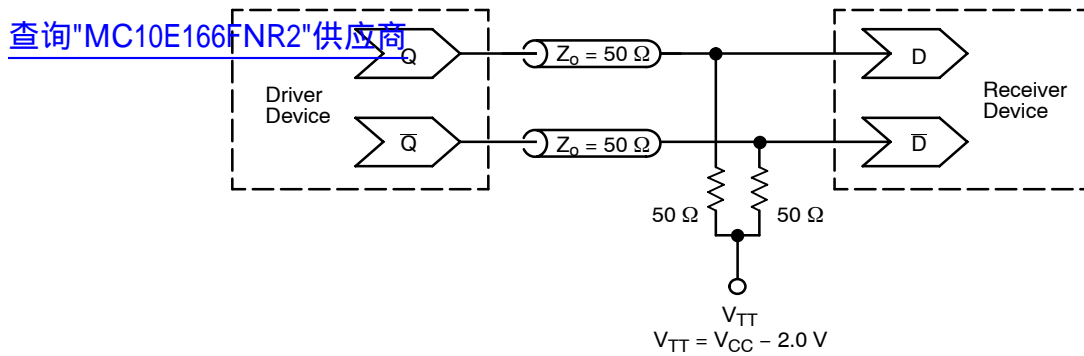

Figure 3. Typical Termination for Output Driver and Device Evaluation
(See Application Note AND8020/D – Termination of ECL Logic Devices.)

ORDERING INFORMATION

Device	Package	Shipping [†]
MC10E166FN	PLCC-28	37 Units / Rail
MC10E166FNG	PLCC-28 (Pb-Free)	37 Units / Rail
MC10E166FNR2	PLCC-28	500 / Tape & Reel
MC10E166FNR2G	PLCC-28 (Pb-Free)	500 / Tape & Reel
MC100E166FN	PLCC-28	37 Units / Rail
MC100E166FNR2	PLCC-28	500 / Tape & Reel
MC100E166FNR2G	PLCC-28 (Pb-Free)	500 / Tape & Reel

[†]For information on tape and reel specifications, including part orientation and tape sizes, please refer to our Tape and Reel Packaging Specifications Brochure, BRD8011/D.

Resource Reference of Application Notes

- AN1405/D** – ECL Clock Distribution Techniques
- AN1406/D** – Designing with PECL (ECL at +5.0 V)
- AN1503/D** – ECLinPS™ I/O SPiCE Modeling Kit
- AN1504/D** – Metastability and the ECLinPS Family
- AN1568/D** – Interfacing Between LVDS and ECL
- AN1672/D** – The ECL Translator Guide
- AND8001/D** – Odd Number Counters Design
- AND8002/D** – Marking and Date Codes
- AND8020/D** – Termination of ECL Logic Devices
- AND8066/D** – Interfacing with ECLinPS
- AND8090/D** – AC Characteristics of ECL Devices

MC10E166, MC100E166

查询"MC10E166FNR2"供应商

PACKAGE DIMENSIONS

PLCC-28
FN SUFFIX
PLASTIC PLCC PACKAGE
CASE 776-02
ISSUE E

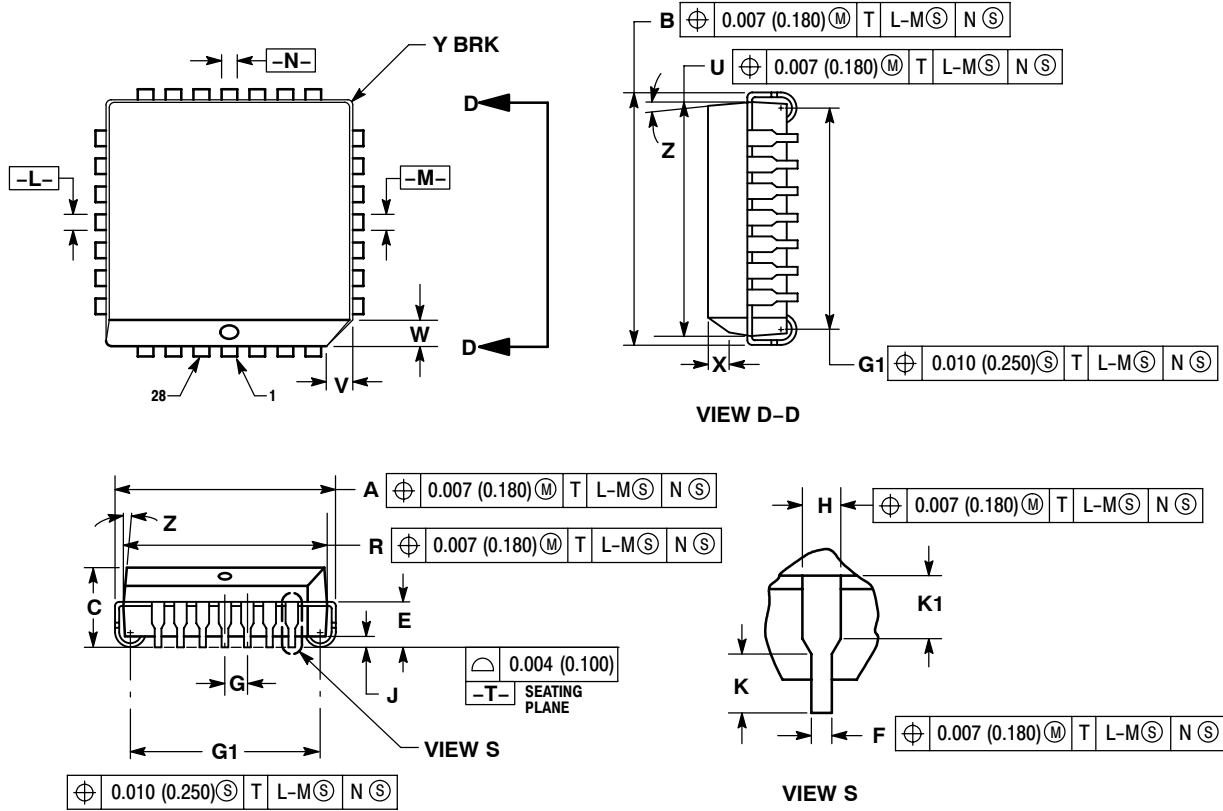

NOTES:

- DATUMS -L-, -M-, AND -N- DETERMINED WHERE TOP OF LEAD SHOULDER EXITS PLASTIC BODY AT MOLD PARTING LINE.
- DIMENSION G1, TRUE POSITION TO BE MEASURED AT DATUM -T-, SEATING PLANE.
- DIMENSIONS R AND U DO NOT INCLUDE MOLD FLASH. ALLOWABLE MOLD FLASH IS 0.010 (0.250) PER SIDE.
- DIMENSIONING AND TOLERANCING PER ANSI Y14.5M, 1982.
- CONTROLLING DIMENSION: INCH.
- THE PACKAGE BOTTOM MAY BE SMALLER THAN THE PACKAGE TOP BY UP TO 0.012 (0.300). DIMENSIONS R AND U ARE DETERMINED AT THE OUTERMOST EXTREMES OF THE PLASTIC BODY EXCLUSIVE OF MOLD FLASH, TIE BAR BURRS, GATE BURRS AND INTERLEAD FLASH, BUT INCLUDING ANY MISMATCH BETWEEN THE TOP AND BOTTOM OF THE PLASTIC BODY.
- DIMENSION H DOES NOT INCLUDE DAMBAR PROTRUSION OR INTRUSION. THE DAMBAR PROTRUSION(S) SHALL NOT CAUSE THE H DIMENSION TO BE GREATER THAN 0.037 (0.940). THE DAMBAR INTRUSION(S) SHALL NOT CAUSE THE H DIMENSION TO BE SMALLER THAN 0.025 (0.635).

DIM	INCHES		MILLIMETERS	
	MIN	MAX	MIN	MAX
A	0.485	0.495	12.32	12.57
B	0.485	0.495	12.32	12.57
C	0.165	0.180	4.20	4.57
E	0.090	0.110	2.29	2.79
F	0.013	0.019	0.33	0.48
G	0.050 BSC		1.27 BSC	
H	0.026	0.032	0.66	0.81
J	0.020	---	0.51	---
K	0.025	---	0.64	---
R	0.450	0.456	11.43	11.58
U	0.450	0.456	11.43	11.58
V	0.042	0.048	1.07	1.21
W	0.042	0.048	1.07	1.21
X	0.042	0.056	1.07	1.42
Y	---	0.020	---	0.50
Z	2° 10°		2° 10°	
G1	0.410	0.430	10.42	10.92
K1	0.040	---	1.02	---

MC10E166, MC100E166

[查询"MC10E166FNR2"供应商](#)

ECLinPS is a trademark of Semiconductor Components Industries, LLC (SCILLC).

ON Semiconductor and  are registered trademarks of Semiconductor Components Industries, LLC (SCILLC). SCILLC reserves the right to make changes without further notice to any products herein. SCILLC makes no warranty, representation or guarantee regarding the suitability of its products for any particular purpose, nor does SCILLC assume any liability arising out of the application or use of any product or circuit, and specifically disclaims any and all liability, including without limitation special, consequential or incidental damages. "Typical" parameters which may be provided in SCILLC data sheets and/or specifications can and do vary in different applications and actual performance may vary over time. All operating parameters, including "Typicals" must be validated for each customer application by customer's technical experts. SCILLC does not convey any license under its patent rights nor the rights of others. SCILLC products are not designed, intended, or authorized for use as components in systems intended for surgical implant into the body, or other applications intended to support or sustain life, or for any other application in which the failure of the SCILLC product could create a situation where personal injury or death may occur. Should Buyer purchase or use SCILLC products for any such unintended or unauthorized application, Buyer shall indemnify and hold SCILLC and its officers, employees, subsidiaries, affiliates, and distributors harmless against all claims, costs, damages, and expenses, and reasonable attorney fees arising out of, directly or indirectly, any claim of personal injury or death associated with such unintended or unauthorized use, even if such claim alleges that SCILLC was negligent regarding the design or manufacture of the part. SCILLC is an Equal Opportunity/Affirmative Action Employer. This literature is subject to all applicable copyright laws and is not for resale in any manner.

PUBLICATION ORDERING INFORMATION

LITERATURE FULFILLMENT:

Literature Distribution Center for ON Semiconductor
P.O. Box 5163, Denver, Colorado 80217 USA
Phone: 303-675-2175 or 800-344-3860 Toll Free USA/Canada
Fax: 303-675-2176 or 800-344-3867 Toll Free USA/Canada
Email: orderlit@onsemi.com

N. American Technical Support: 800-282-9855 Toll Free
USA/Canada
Europe, Middle East and Africa Technical Support:
Phone: 421 33 790 2910
Japan Customer Focus Center
Phone: 81-3-5773-3850

ON Semiconductor Website: www.onsemi.com
Order Literature: <http://www.onsemi.com/orderlit>

For additional information, please contact your local Sales Representative

MC10E166/D