

MC3446 QUADRUPLE BUS TRANSCEIVER

D2290, JANUARY 1977—REVISED SEPTEMBER 1986

- Driver Inputs Compatible with TTL and MOS Circuitry
- Driver Outputs Stay Off During Power Up and Power Down
- Drivers Feature Open-Collector Outputs for Party-Line Operation
- Designed for Interchangeability with Motorola MC3446
- Meet IEEE Standard 488-1975

D, J, OR N DUAL-IN-LINE PACKAGE
(TOP VIEW)

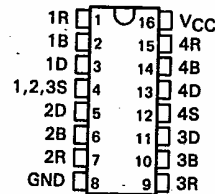

description

These circuits are quadruple single-ended line transceivers designed for bidirectional flow of data and instructions. The bus terminal characteristic complies with paragraph 3.5.3 of IEEE Standard 488 (see Figure 3). Each driver output is tied to the junction of an internal voltage divider that sets the no-load output voltage and provides bus termination. The driver outputs are guaranteed to be "off" during power up and power down if either input is high. The receivers feature 950 millivolts typical hysteresis for noise immunity.

The MC3446 is characterized for operation from 0°C to 70°C.

FUNCTION TABLE
(TRANSMITTING)

INPUTS		OUTPUT	
S	D	B	R
L	H	H	H
L	L	L	L

FUNCTION TABLE
(RECEIVING)

INPUTS			OUTPUT
S	B	D	R
H	H	X	H
H	L	X	L

logic diagram (positive logic)

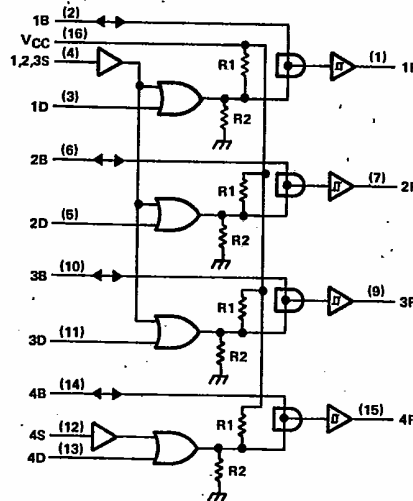

R1 = 2.4 kΩ NOM, R2 = 5 kΩ NOM

logic symbol†

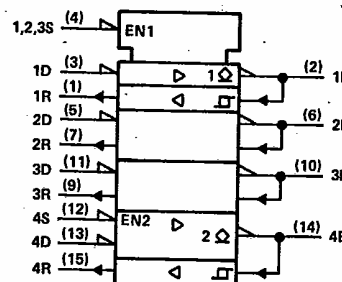

† This symbol is in accordance with ANSI/JEDEC Std 91-1984 and IEC Publication 617-12.

PRODUCTION DATA documents contain information current as of publication date. Products conform to specifications per the terms of Texas Instruments standard warranty. Production processing does not necessarily include testing of all parameters.

TEXAS INSTRUMENTS

POST OFFICE BOX 655012 • DALLAS, TEXAS 75265

Copyright © 1986, Texas Instruments Incorporated

4
Line Drivers/Receivers

**MC3446
QUADRUPLE BUS TRANSCEIVER**

T-52-31

schematics of inputs and outputs

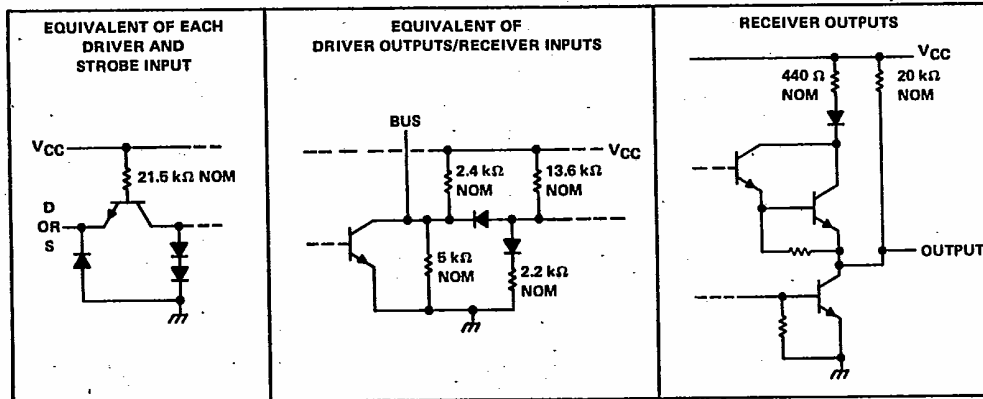

Line Drivers/Receivers

absolute maximum ratings over operating free-air temperature range (unless otherwise noted)

Supply voltage, VCC (see Note 1)	7 V
Input voltage	5.5 V
Driver output current	150 mA
Continuous total dissipation at (or below) 25°C free-air temperature (see Note 2):	
D package	950 mW
J package	1025 mW
N package	1050 mW
Operating free-air temperature range	0°C to 70°C
Storage temperature range	-65°C to 150°C
Lead temperature 1,6 mm (1/16 inch) from case for 60 seconds: J package	300°C
Lead temperature 1,6 mm (1/16 inch) from case for 10 seconds: D and N package	260°C

- NOTES: 1. Voltage values are with respect to network ground terminal.
 2. For operation above 25°C free-air temperature, refer to Dissipation Derating Curves in Appendix A. In the J package, use the 8.2 mW/°C curve, in the D package, use the 7.6 mW/°C curve, and in the N package, use the 9.2-mW/°C curve.

recommended operating conditions

		MIN	NOM	MAX	UNIT
Supply voltage, VCC		4.75	5	5.25	V
High-level input voltage, VIH	D or S	2			V
Low-level input voltage, VIL	D or S			0.8	V
High-level output current, IOH	Receiver			-0.4	mA
Low-level output current, IOL	Driver			48	mA
	Receiver			8	mA
Operating free-air temperature, TA		0		70	°C

**MC3446
QUADRUPLE BUS TRANSCEIVER**

T-52-31

electrical characteristics over recommended ranges of VCC and operating free-air temperature (unless otherwise noted)

PARAMETER			TEST CONDITIONS	MIN	TYP†	MAX	UNIT
V _{IK}	Input clamp voltage	D or S	I _I = -12 mA			-1.5	V
V _{T+}	Positive-going input threshold voltage	B		1.5	1.8	2	V
V _{T-}	Negative-going input threshold voltage	B		0.6	0.85	1.1	V
V _{hys}	Input hysteresis, (V _{T+} - V _{T-})	B		400	950		mV
V _{OH}	High-level output voltage	B	V _{IH} = 2.4 V, I _{OH} = 0	2.5	3.3	3.7	V
		R	V _{IH} = 2 V, I _{OH} = -400 μA	2.4			
V _{OL}	Low-level output voltage	B	V _{IL} = 0.8 V, I _{OL} = 48 mA			0.4	V
		R	V _{IL} = 0.8 V, I _{OL} = 8 mA			0.4	
I _{O(bus)}	Bus current	B	V _{IH} = 2.4 V, V _O = 5.5 V			2.5	mA
			V _{IH} = 2.4 V, V _O = 5 V	0.7			
			V _{IH} = 2.4 V, V _O = 0.4 V	-1.3		-3.2	
V _{OK}	Output clamp voltage	B	I _O = -12 mA			-1.5	V
I _I	Input current at maximum input voltage	D or S	V _I = 5.5 V			1	mA
I _{IH}	High-level input current	D or S	V _{IH} = 2.4 V		5	20	μA
I _{IL}	Low-level input current	D or S	V _{CC} = 5 V, V _{IL} = 0.4 V, T _A = 25°C		0.2	0.36	mA
I _{OS}	Short-circuit output current	R	V _{IH} = 2 V		4	14	mA
I _{CCH}	Supply current, all outputs high		No load		10	19	mA
I _{CCL}	Supply current, all outputs low		No load		32	39	mA

†All typical values are at VCC = 5 V, TA = 25°C.

switching characteristics, VCC = 5 V, TA = 25°C

PARAMETER	FROM	TO	TEST CONDITIONS	MIN	MAX	UNIT
t _{PLH}	D	B	See Figure 1		40	ns
t _{PHL}					50	
t _{PLH}	S	B			50	ns
t _{PHL}					50	
t _{PLH}	B	R	See Figure 2		50	ns
t _{PHL}					40	



Line Drivers/Receivers

**MC3446
QUADRUPLE BUS TRANSCEIVER**

T-52-31

PARAMETER MEASUREMENT INFORMATION

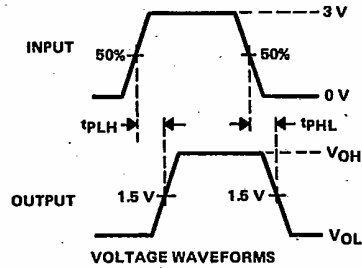
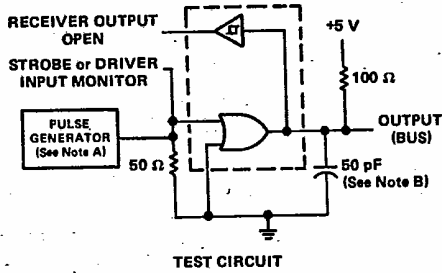

FIGURE 1

4
Line Drivers/Receivers

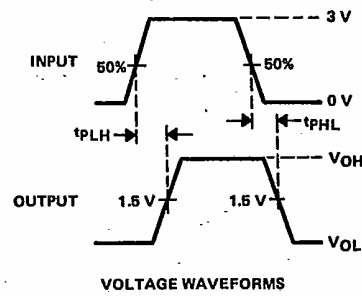
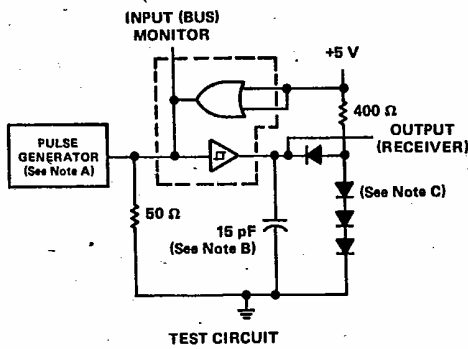

FIGURE 2

NOTES: A. The input pulse is supplied by a generator having the following characteristics: $t_W = 100$ ns, $PRR \leq 1$ MHz, $t_r \leq 10$ ns, $t_f \leq 10$ ns, $Z_{out} \approx 50 \Omega$.
 B. This value includes probe and jig capacitance.
 C. All diodes are 1N916 or 1N3064.

TYPICAL CHARACTERISTICS

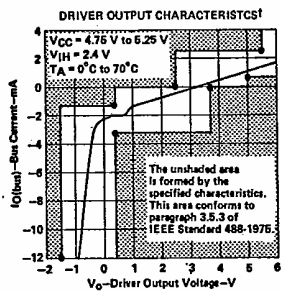

FIGURE 3

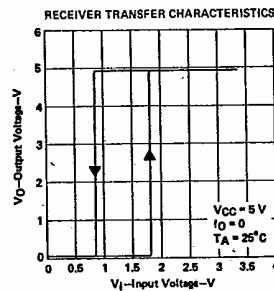

FIGURE 4

†Conditions for typical curve are $V_{CC} = 5$ V, $T_A = 25^\circ\text{C}$.