

DATA SHEET

# SKY65228-11: WLAN 802.11n Single Band 4.9–5.85 GHz MIMO Inter<sup>TM</sup> Front-End Module

## Features

- Single band 4.9–5.85 GHz MIMO architecture
- Two full 4.9–5.85 GHz transmit/receive chains
- Backward-compatible with 802.11a standards
- Pin compatible with SKY65225-11 (4.9–5.85 GHz)
- $P_{OUT}$  @ 2.5% EVM: 16 dBm (-11a)
- Gain matching: <2 dB
- Internal voltage regulation
- Single 3.0–3.6 V power supply
- Temperature-compensated PA bias networks
- Separate digital controls for each PA
- Temperature-compensated directional power detection
- Package size: 10 x 14 x 0.9 mm
- Lead (Pb)-free and RoHS-compliant MSL-3 @ 250 °C per JEDEC J-STD-020

## Description

The SKY65228-11 Inter<sup>n</sup>FEM contains two complete 4.9–5.85 GHz transmit/receive chains in one compact RF front-end module optimized for single band 4.9–5.85 GHz MIMO (multiple in—multiple out) operation, in compliance with the 802.11n draft standard. The SKY65228-11 includes two 4.9–5.85 GHz PAs with integrated input filtering for 3–4 GHz rejection, and temperature-compensated, directional power detector with 20 dB dynamic range. Also included are low loss, high rejection GaAs harmonic filters and T/R switches which provide high linearity in all transmit paths and low loss in all receive paths.

The SKY65228-11 Inter<sup>n</sup>FEM achieves outstanding gain matching which is a critical requirement for MIMO operation. This is accomplished through mirrored layout symmetry.

The SKY65228-11 is packaged in a lead (Pb)-free, RoHS-compliant laminate package, which measures 10 x 14 x 0.9 mm. This FEM is designed as a pin to pin compatible version of the SKY65225-11 for 4.9–5.85 GHz only.

**NEW** Skyworks offers lead (Pb)-free, RoHS (Restriction of Hazardous Substances)-compliant packaging.



## Functional Block Diagram

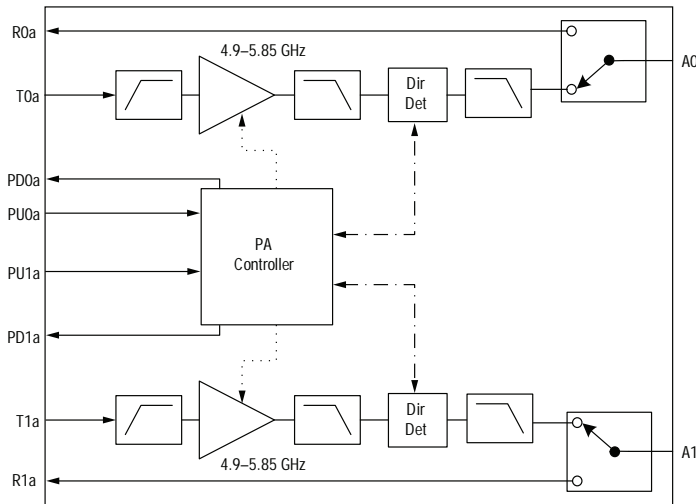

Innovation to Go™  
Now available for purchase online.

[查询"SKY65228-11"供应商](#)

### Absolute Maximum Ratings

Parameter	Symbol	Condition	Min.	Typ.	Max.	Unit
V <sub>CC</sub>	V <sub>CC</sub>		-0.3		5.5	V
PU0a, PU1a	PU		-0.3		5.5	V
T0a, T1a	RFin				10	dBm
Operating temperature range	T <sub>OP</sub>		0		85	°C
Storage temperature range	T <sub>STO</sub>		-65		125	°C
Moisture sensitivity level	MSL-3				250	°C
Thermal resistance	θ <sub>JC</sub>				60	°C/W

Performance is guaranteed only under the conditions listed in the specifications table and is not guaranteed under the full range(s) described by the Absolute Maximum specifications. Exceeding any of the absolute maximum/minimum specifications may result in permanent damage to the device and will void the warranty.

### Recommended Operating Conditions

Parameter	Symbol	Condition	Min.	Typ.	Max.	Unit
Supply Voltage	V <sub>CC</sub>		3	3.3	3.6	V
Operating Temperature	T <sub>OP</sub>		0	25	85	°C

### DC Characteristics

**Conditions: V<sub>CC</sub> = 3.3 V, T<sub>OP</sub> = 25 °C. Measurements made on Skyworks EVB with all losses de-embedded.**

**All unused ports terminated into 50 Ω unless otherwise specified.**

Parameter	Symbol	Condition	Min.	Typ.	Max.	Unit
Total 802.11a Tx supply current, T0a or T1a	I <sub>CC-a</sub>	P <sub>OUT</sub> = 15 dBm, 54 Mbps OFDM, PU0g or PU1g = 0 V PU0a or PU1a = 3.3 V		180		mA
Total 802.11a Tx quiescent current, T0a or T1a	I <sub>CQ-a</sub>	No RF		135		mA

### PA Logic Characteristics

**Conditions: V<sub>CC</sub> = 3.3 V, T<sub>OP</sub> = 25 °C. Measurements made on Skyworks EVB with all losses de-embedded.**

**All unused ports terminated into 50 Ω unless otherwise specified.**

Parameter	Symbol	Condition	Min.	Typ.	Max.	Unit
Logic high voltage for PU0a, PU1a (Tx On)			2		V <sub>CC</sub>	V
Logic low voltage for PU0a, PU1a (Tx Off)			0		0.5	V
Input current logic high voltage for PU0a, PU1a				100	200	μA
Input current logic low voltage for PU0a, PU1a				0.2		μA

[查询"SKY65228-11"供应商](#)**Switch Characteristics**

**Conditions:  $V_{CC} = 3.3\text{ V}$ ,  $T_{OP} = 25\text{ }^{\circ}\text{C}$ . Measurements made on Skyworks EVB with all losses de-embedded.  
All unused ports terminated into  $50\ \Omega$  unless otherwise specified.**

Parameter	Symbol	Condition	Min.	Typ.	Max.	Unit
Control voltage - ON state	$V_{CTL\_on}$		3	3.3	3.6	V
Control voltage - OFF state	$V_{CTL\_off}$		0		0.2	V
Control current - ON state	$I_{CTL\_on}$	RF ON		10	75	$\mu\text{A}$
Control current - ON state	$I_{CTL\_on}$	RF OFF		2	20	$\mu\text{A}$

**Mode Control Voltage Table (V)**

Mode	$V_{CC}$	PU0a	Rx0a	Tx0a	PU1a	Rx1a	Tx1a
Sleep	3.3	0	0	0	0	0	0
T0a - ANT0	3.3	3.3	0	3.3	0	0	0
R0a - ANT0	3.3	0	3.3	0	0	0	0
T1a - ANT1	3.3	0	0	0	3.3	0	3.3
R1a - ANT1	3.3	0	0	0	0	3.3	0
<b>802.11n Operation</b>							
T0a - ANT0 & T1a - ANT1	3.3	3.3	0	3.3	3.3	0	3.3
R0a - ANT0 & R1a - ANT1	0 or 3.3	0	3.3	0	0	3.3	0

**CAUTION:** Although this device is designed to be as robust as possible, Electrostatic Discharge (ESD) can damage this device. This device must be protected at all times from ESD. Static charges may easily produce potentials of several kilovolts on the human body or equipment, which can discharge without detection. Industry-standard ESD precautions should be employed at all times.

[查询"SKY65228-11"供应商](#)

### 802.11a Transmit Specifications (Tx Chain 0, Tx Chain 1)

**Conditions:  $V_{CC} = 3.3\text{ V}$ ,  $T_{OP} = 25\text{ }^\circ\text{C}$ . PA enables and control voltages set according to Mode Control Voltage table. Measurements made on Skyworks EVB with all losses de-embedded. All unused ports terminated into  $50\ \Omega$  unless otherwise specified.**

Parameter	Symbol	Condition	Min.	Typ.	Max.	Unit
Frequency range	F		4.9		5.85	GHz
Linear output power - a	Plin_a	54 Mbps OFDM, 64 QAM, EVM = 2.5 %		16		dBm
Backed off EVM	BEVM	54 Mbps OFDM, 64 QAM, Pin = 7dBm		1.5		%
1 dB compression point	$P_{1\text{ dB}}$		21.5	24		dBm
Small signal gain	$IS_{21} $			24		dB
Small signal gain variation over any 20 MHz band	$ \Delta S_{21} $				0.5	dB
Gain matching, T0g to A0 vs. T1g to A1	$IS_{21}  - M$	Compared frequency by frequency		2		dB
Gain, 3.2–3.9 GHz	$IS_{21}  - 3.9$			0		dB
Harmonics	2f, 3f	$P_{OUT} = 18\text{ dBm}$ , 1 Mbps, CCK, 802.11b		-50	-42	dBm/MHz
Tx switching time	$t_{sw}$	50 % of $V_{CTL}$ to 90/10 % RF output power level			500	ns
Input return loss	$IS_{11} $	T0a or T1a		-6		dB
Output return loss	$IS_{22} $	A0 or A1		-10		dB
Isolation between T0g and A1	ISO-A1	CW power into T0a and measure ratio of power at A0 to A1			-25	dBc
Isolation between T1g and A0	ISO-A0	CW power into T1a and measure ratio of power at A1 to A0			-25	dBc
Stability	STAB	$P_{OUT} \leq 18\text{ dBm}$ , load VSWR = 3:1	All non-harmonically related outputs less than -50 dBc/1 MHz			

### 802.11a Receive Specifications (Rx Chain 0, Rx Chain 1)

**Conditions:  $V_{CC} = 3.3\text{ V}$ ,  $T_{OP} = 25\text{ }^\circ\text{C}$ . PA enables & Tx control voltages = 0 V. Rx0ag or Rx1ag = 3.3 V. Measurements made on Skyworks EVB with all losses de-embedded. All unused ports terminated into  $50\ \Omega$  unless otherwise specified.**

Parameter	Symbol	Condition	Min.	Typ.	Max.	Unit
Frequency range	F		4.9		5.85	GHz
Insertion loss	$IS_{21} $			2.5	3	dB
Input return loss	$IS_{11} $	R0g or R1g		-20		dB
Output return loss	$IS_{22} $	A0 or A1		-15		dB
Insertion loss delta	$ \Delta S_{21} $	A0 to R0g and A1 to R1g			0.5	dB

### 802.11a Power Detector Specification

**Conditions:  $V_{CC} = 3.3\text{ V}$ ,  $T_{OP} = 25\text{ }^\circ\text{C}$ . PU0a and Tx0ag or PU1a and Tx1ag = 3.3 V. RX0ag or RX1ag = 0 V. Measurements made on Skyworks EVB with all losses de-embedded. All unused ports terminated into  $50\ \Omega$  unless otherwise specified.**

Parameter	Symbol	Condition	Min.	Typ.	Max.	Unit
Frequency range	F		4.9		5.85	GHz
Power detect range	PDR	A0 or A1	0		20	dBm
Power detector accuracy	PDacc5	Over 3:1 VSWR		0.7		dB
DC load impedance	Zload				3	$k\Omega$
Output voltage, no RF				0.90		V
Output voltage, 18 dBm				0.35		V
Power detector -3 dB corner frequency	LPF-3 dB	10 $k\Omega$ load	270	300	400	kHz

[查询"SKY65228-11"供应商](#)

**Typical Performance Data (4.9–5.85 GHz)**

**V<sub>CC</sub> = 3.3 V, T<sub>A</sub> = 25 °C, OFDM 54 Mbps, Z<sub>0</sub> = 50 Ω, unless otherwise noted**

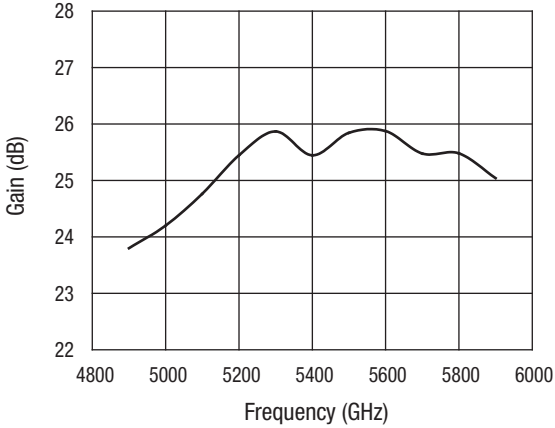
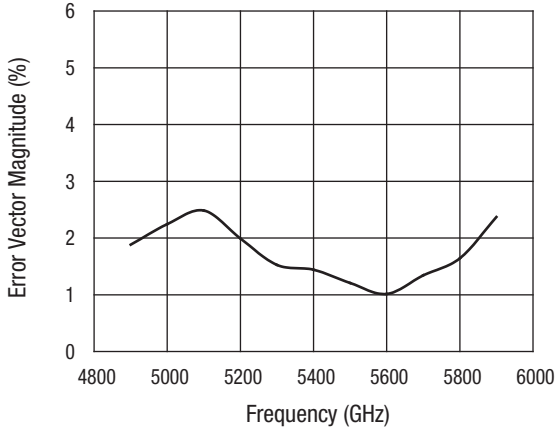

**EVM vs. Frequency (P<sub>OUT</sub> = 15 dBm)**

**Gain vs. Frequency**

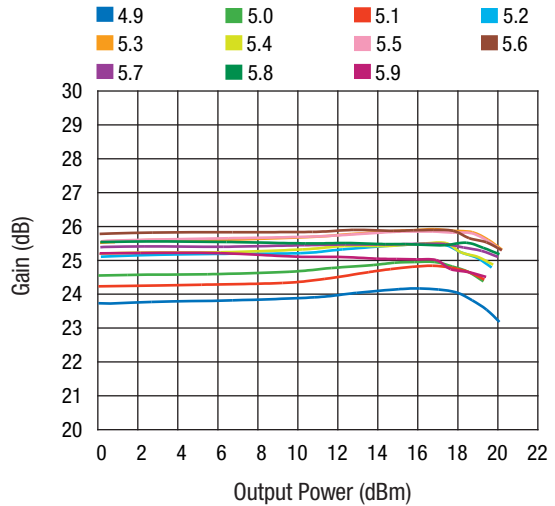
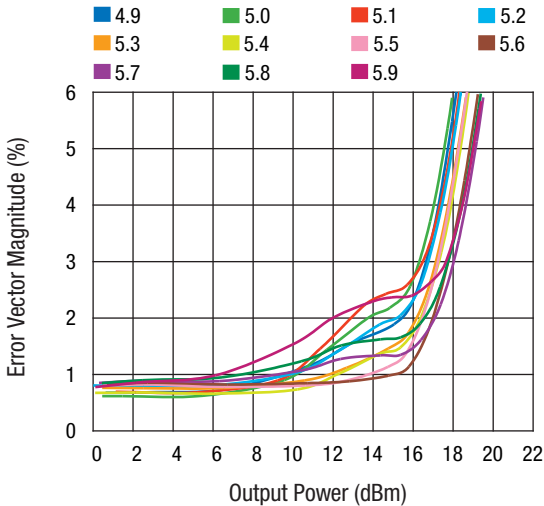

**EVM vs. Output Power**

**Gain vs. Output Power**

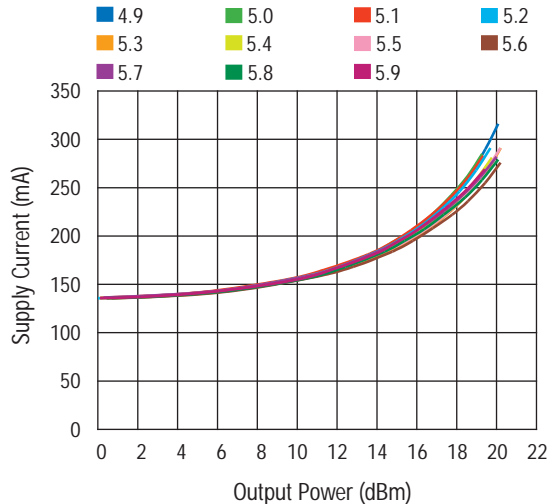
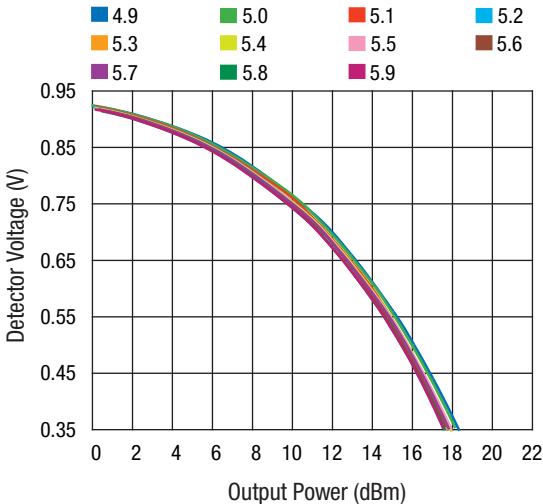

**Detector Voltage vs. Output Power**

**Supply Current vs. Output Power**

[查询"SKY65228-11"供应商](#)

**Pin Out**

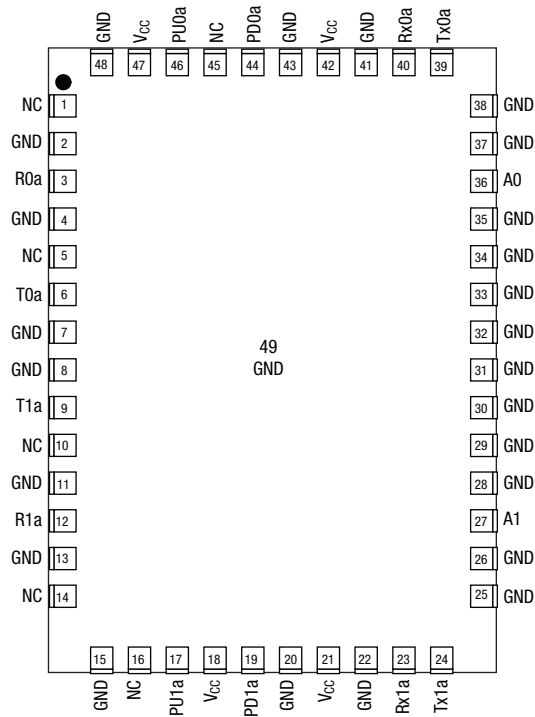

**Pin Descriptions**

Pin #	Pin Name	Description	EVB Label
1	NC	No connection	NC
2	GND	Ground	GND
3	ROa	Receiver output	ROa
4	GND	Ground	GND
5	NC	No connection	NC
6	TOa	Transmitter input	TOa
7	GND	Ground	GND
8	GND	Ground	GND
9	T1a	Transmitter input	T1a
10	NC	No connection	NC
11	GND	Ground	GND
12	R1a	Receiver output	R1a
13	GND	Ground	GND
14	NC	No connection	NC
15	GND	Ground	GND
16	NC	No connection	NC
17	PU1a	Power amplifier enable input	VEN1a
18	V <sub>CC</sub>	3.3 V	None. Tied to Pin 47
19	PD1a	Power detector output voltage from PA1	VD1ag
20	GND	Ground	GND
21	V <sub>CC</sub>	3.3 V	None. Tied to Pin 47
22	GND	Ground	GND
23	Rx1a	Switch control input	Rx1ag
24	Tx1a	Switch control input	Tx1ag
25	GND	Ground	GND
26	GND	Ground	GND
27	A1	Antenna 1	A1
28	GND	Ground	GND
29	GND	Ground	GND
30	GND	Ground	GND
31	GND	Ground	GND
32	GND	Ground	GND
33	GND	Ground	GND
34	GND	Ground	GND
35	GND	Ground	GND
36	AO	Antenna 0	AO
37	GND	Ground	GND
38	GND	Ground	GND
39	Tx0a	Switch control input	Tx0ag
40	Rx0a	Switch control input	Rx0ag
41	GND	Ground	GND
42	V <sub>CC</sub>	3.3 V	None. Tied to Pin 47
43	GND	Ground	GND
44	PDOa	Power detector output voltage from PA0	VDOag
45	NC	No connection	VEN0g
46	PU0a	Power amplifier enable input	VEN0a
47	V <sub>CC</sub>	3.3 V	V <sub>CC</sub>
48	GND	Ground	GND
49	GND	Ground	GND

[查询"SKY65228-11"供应商](#)

**Recommended Footprint**

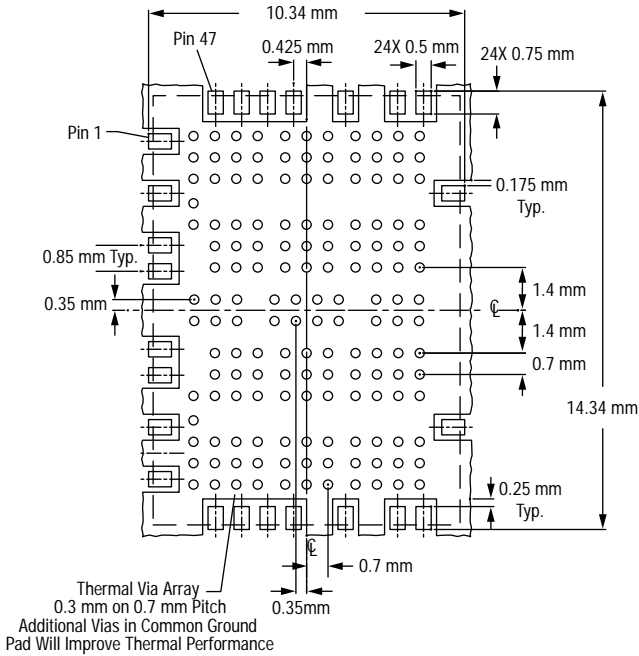

Thermal vias should be tented and filled with solder mask 30–35 µm copper plating recommended.

**Solder Mask**

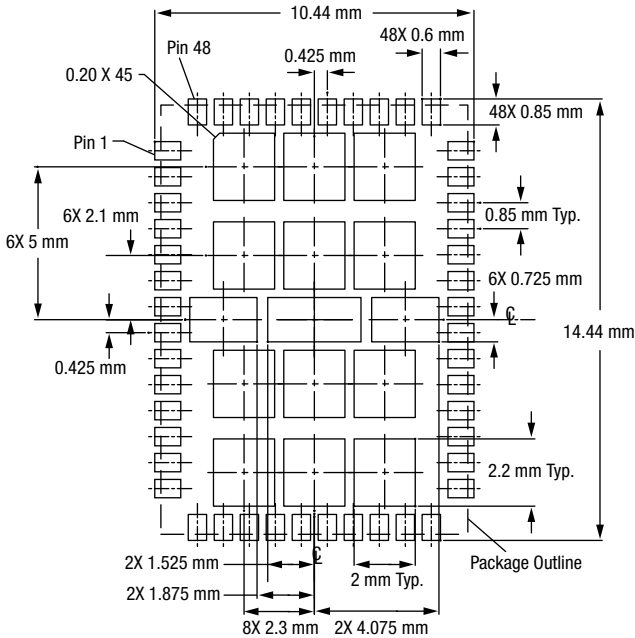

**Stencil Pattern**

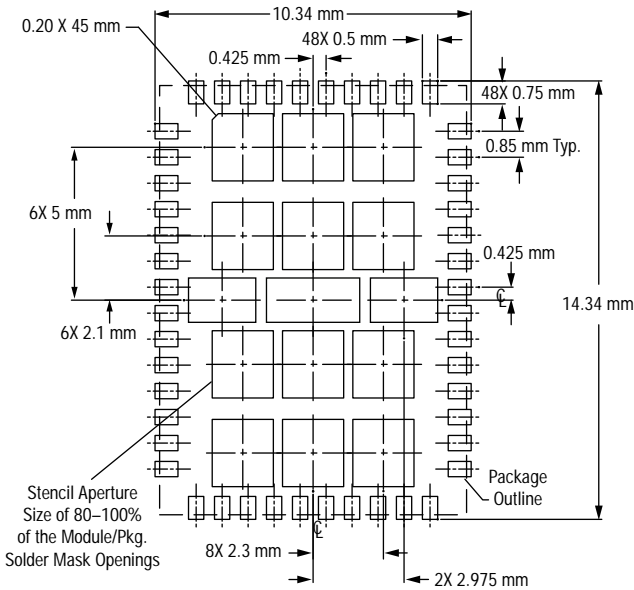

[查询"SKY65228-11"供应商](#)  
**Package Outline**

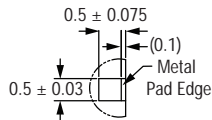
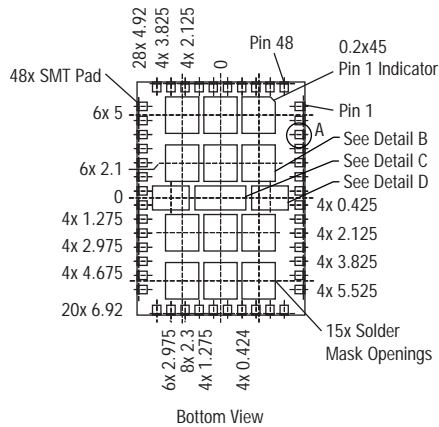
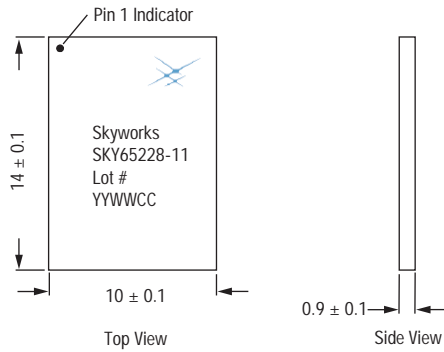

Detail A  
 Pad Scale: 2X  
 14X Rotated 180°  
 10X Rotated 90° CW  
 10X Rotated 90° CCW

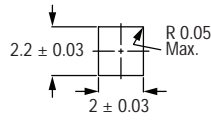

Detail B  
 Scale: Full  
 12X

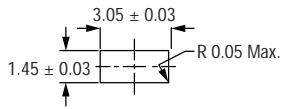

Detail C  
 Scale: Full

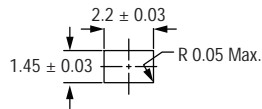

Detail D  
 Scale: Full  
 2X



[查询"SKY65228-11"供应商](#)

Copyright © 2006, 2007, Skyworks Solutions, Inc. All Rights Reserved.

Information in this document is provided in connection with Skyworks Solutions, Inc. ("Skyworks") products or services. These materials, including the information contained herein, are provided by Skyworks as a service to its customers and may be used for informational purposes only by the customer. Skyworks assumes no responsibility for errors or omissions in these materials or the information contained herein. Skyworks may change its documentation, products, services, specifications or product descriptions at any time, without notice. Skyworks makes no commitment to update the materials or information and shall have no responsibility whatsoever for conflicts, incompatibilities, or other difficulties arising from any future changes.

No license, whether express, implied, by estoppel or otherwise, is granted to any intellectual property rights by this document. Skyworks assumes no liability for any materials, products or information provided hereunder, including the sale, distribution, reproduction or use of Skyworks products, information or materials, except as may be provided in Skyworks Terms and Conditions of Sale.

THE MATERIALS, PRODUCTS AND INFORMATION ARE PROVIDED "AS IS" WITHOUT WARRANTY OF ANY KIND, WHETHER EXPRESS, IMPLIED, STATUTORY, OR OTHERWISE, INCLUDING FITNESS FOR A PARTICULAR PURPOSE OR USE, MERCHANTABILITY, PERFORMANCE, QUALITY OR NON-INFRINGEMENT OF ANY INTELLECTUAL PROPERTY RIGHT; ALL SUCH WARRANTIES ARE HEREBY EXPRESSLY DISCLAIMED. SKYWORKS DOES NOT WARRANT THE ACCURACY OR COMPLETENESS OF THE INFORMATION, TEXT, GRAPHICS OR OTHER ITEMS CONTAINED WITHIN THESE MATERIALS. SKYWORKS SHALL NOT BE LIABLE FOR ANY DAMAGES, INCLUDING BUT NOT LIMITED TO ANY SPECIAL, INDIRECT, INCIDENTAL, STATUTORY, OR CONSEQUENTIAL DAMAGES, INCLUDING WITHOUT LIMITATION, LOST REVENUES OR LOST PROFITS THAT MAY RESULT FROM THE USE OF THE MATERIALS OR INFORMATION, WHETHER OR NOT THE RECIPIENT OF MATERIALS HAS BEEN ADVISED OF THE POSSIBILITY OF SUCH DAMAGE.

Skyworks products are not intended for use in medical, lifesaving or life-sustaining applications, or other equipment in which the failure of the Skyworks products could lead to personal injury, death, physical or environmental damage. Skyworks customers using or selling Skyworks products for use in such applications do so at their own risk and agree to fully indemnify Skyworks for any damages resulting from such improper use or sale.

Customers are responsible for their products and applications using Skyworks products, which may deviate from published specifications as a result of design defects, errors, or operation of products outside of published parameters or design specifications. Customers should include design and operating safeguards to minimize these and other risks. Skyworks assumes no liability for applications assistance, customer product design, or damage to any equipment resulting from the use of Skyworks products outside of stated published specifications or parameters.

Skyworks, the Skyworks symbol, "Breakthrough Simplicity" and Intera are trademarks or registered trademarks of Skyworks Solutions, Inc., in the United States and other countries. Third-party brands and names are for identification purposes only, and are the property of their respective owners. Additional information, including relevant terms and conditions, posted at [www.skyworksinc.com](http://www.skyworksinc.com), are incorporated by reference.