

Model 6721 Do-It Yourself Multi-Stacking Sheath Banana Plug

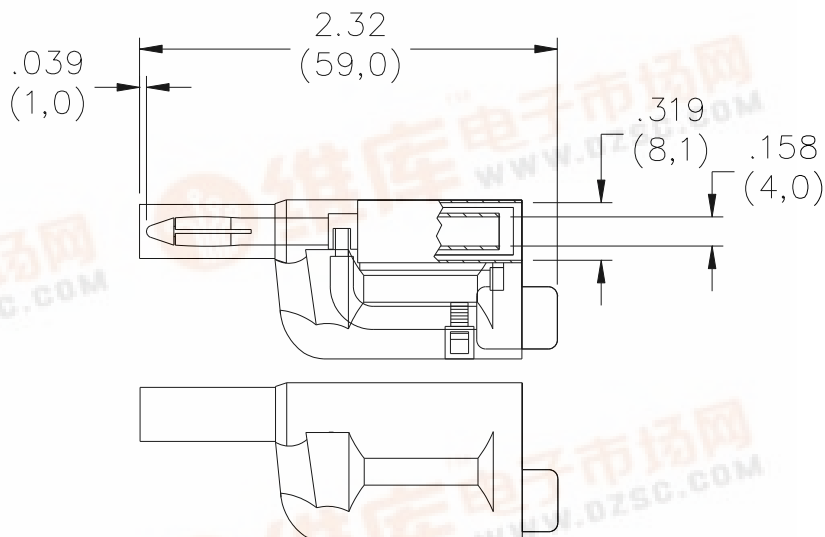

Features:

- ✓ Can be vertically stacked on top of each other
- ✓ Fits standard banana safety-style jacks
- ✓ Fits DMM with safety-style banana jacks
- ✓ Simple assembly
- ✓ Complies to International Safety Standard IEC 1010-2-031
- ✓ Accepts 18 AWG test lead wire (e.g. Pomona model: 6733 or 6734)

Materials:

| | |
|--------------|--------------------------------|
| Banana Jack: | Nickel Plated Brass |
| Banana Plug: | Nickel Plated Beryllium Copper |
| Insulation: | Lucel |

Ratings:

| | |
|--------------------|--|
| Voltage / Current: | * 1000 Vrms, CAT III, 20 A, IEC 1010-2-031 |
| Temperature: | -10 to +55 C |

Ordering Information:

| | |
|--------|---|
| 6721-0 | Black, Do-It-Yourself Stacking Sheath Banana Plug |
| 6721-2 | Red, Do-It-Yourself Stacking Sheath Banana Plug |

* *When plug is correctly assembled and terminated.*

All dimensions are in inches. Tolerances (except noted): .xx = ±.02" (.51 mm), .xxx = ±.005" (.127 mm).

All specifications are to the latest revisions. Specifications are subject to change without notice.

Registered trademarks are the property of their respective companies. Made in USA

Sales: 800-490-2361 Fax: 888-403-3360 Technical Assistance: 800-241-2060
For "Where to Buy" information, visit the Pomona web site at www.pomonaelectronics.com

Model 6721 Do-It Yourself Multi-Stacking Sheath Banana Plug

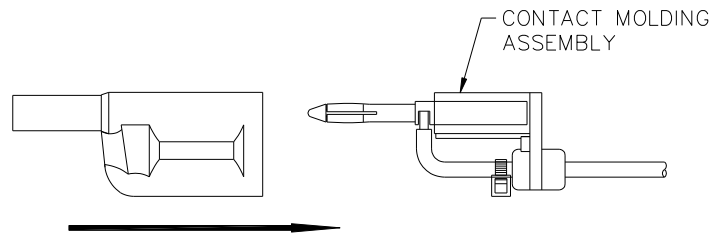
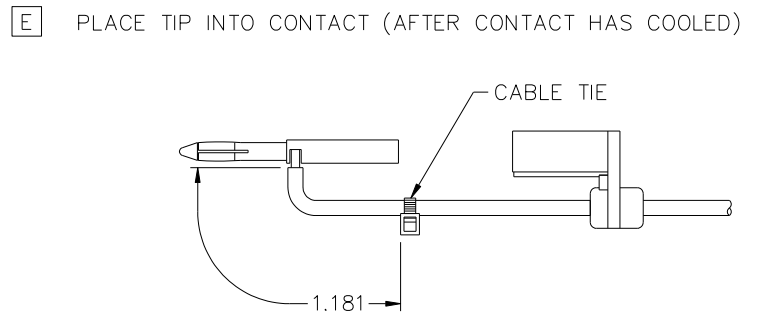
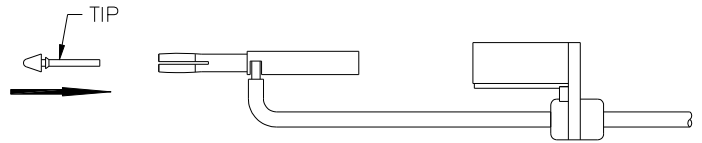
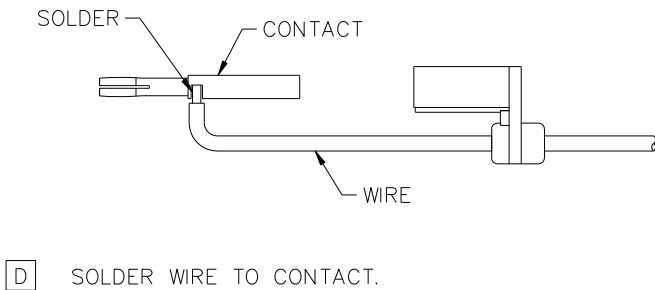
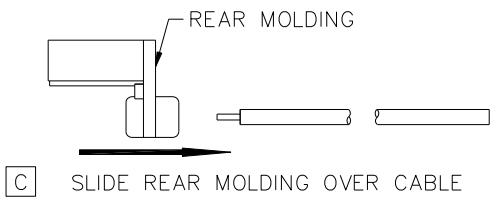
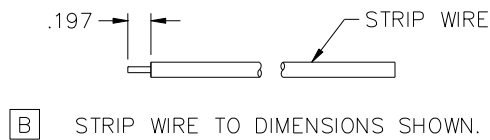
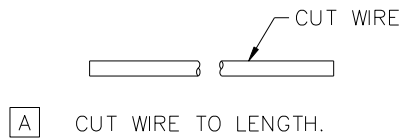

All dimensions are in inches. Tolerances (except noted): .xx = ±.02" (.51 mm), .xxx = ±.005" (.127 mm).
All specifications are to the latest revisions. Specifications are subject to change without notice.
Registered trademarks are the property of their respective companies. Made in USA

Sales: 800-490-2361 Fax: 888-403-3360 Technical Assistance: 800-241-2060
For "Where to Buy" information, visit the Pomona web site at www.pomonaelectronics.com

Model 6721 Do-It Yourself Multi-Stacking Sheath Banana Plug

Pomona®

The items included with this product are certified to meet IEC 1010-2-031 safety requirements.

Les éléments inclus avec ce produit sont certifiés pour répondre à des exigences de sûreté du IEC 1010-2-031.

Los items incluidos con este producto se certifican para resolver requisitos de seguridad del IEC 1010-2-031.

– Only IEC 1010 type shrouded test plugs should be used with IEC 1010 type jacks. NEVER INSERT A PROBE TIP WITH BANANA SPRING INTO A TEST ACCESSORY JACK THAT WILL BE USED AS A HAND HELD PROBING DEVICE

–Seuls les vérificateurs de tension renforcés de type IEC 1010 devraient être utilisés avec des jacks de type IEC 1010. NE JAMAIS INSERER DE BOUT DE SONDE AVEC RESSORT BANANE DANS UN JACK D'ESSAI D'ACCESSOIRES QUI SERA UTILISE COMME DISPOSITIF DE SONDAGE A MAIN.

–Se deben usar sólo tapones de prueba reforzados del tipo IEC 1010 con receptáculos de tipo IEC 1010. NUNCA INTRODUZCA UNA CLAVIJA CON UN MUELLE TIPO BANANA EN UN RECEPTACULO DE PRUEBA QUE A SU VEZ SE USE COMO APARATO DE PRUEBA MANUAL.

IR

Both Direct and Alternating Current.
Courant Continu et Alternatif.
Corriente Directa y Alterna.



Caution ! Refer to Accompanying Documents.
Attention ! Se Reporter aux Documents joints.
; Peligro! Consulte los Documentos Adjuntos.



Double Insulation or Reinforced Insulation.
Isolation Double ou Isolation Renforcée.
Aislamiento Doble o Aislamiento Reforzado.



Caution ! Risk of Electric Shock.
Attention ! Risque de Choc Électrique.
; Peligro! Riesgo de Sacudida Eléctrica.

CAT

Overvoltage Category I, II, III or IV.
Surtension Catégorie I, II, III ou IV.
Sobretensión de Categoría I, II III o IV.

Pomona Electronics



PO Box 9090, Everett, WA 98206-9090 TEL: 800-490-2361

All dimensions are in inches. Tolerances (except noted): .xx = ±.02" (.51 mm), .xxx = ± .005" (.127 mm).

All specifications are to the latest revisions. Specifications are subject to change without notice.

Registered trademarks are the property of their respective companies. Made in USA

Sales: 800-490-2361 Fax: 888-403-3360 Technical Assistance: 800-241-2060
For "Where to Buy" information, visit the Pomona web site at www.pomonaelectronics.com