

# High-Precision, Low-Voltage, Current-Sense Amplifier with Current Output and Chip Select for Multiplexing

## General Description

The MAX9934 high-precision, low-voltage, high-side current-sense amplifier is ideal for both bidirectional (charge/discharge) and unidirectional current measurements in battery-powered portable and laptop devices. Input offset voltage ( $V_{OS}$ ) is a low  $10\mu\text{V}$  (max) at  $+25^\circ\text{C}$  across the  $-0.1\text{V}$  to  $5.5\text{V}$  input common-mode voltage range, and is independent of  $V_{CC}$ . Its precision input specification allows the use of very small sense voltages (typically  $\pm 10\text{mV}$  full-scale) for minimally invasive current sensing.

The output of the MAX9934 is a current proportional to input  $V_{SENSE}$  and is available in either  $25\mu\text{A}/\text{mV}$  or  $5\mu\text{A}/\text{mV}$  gain options ( $G_M$ ) with gain accuracy better than  $0.25\%$  (max) at  $+25^\circ\text{C}$ . A chip select (CS) allows multiplexing of several MAX9934 current outputs to a single microcontroller ADC channel (see the *Typical Operating Circuit*). CS is compatible with  $1.8\text{V}$  and  $3.3\text{V}$  logic systems.

The MAX9934 is designed to operate from a  $2.5\text{V}$  to  $3.6\text{V}$   $V_{CC}$  supply, and draws just  $120\mu\text{A}$  (typ) quiescent current. When powered down ( $V_{CC} = 0$ ),  $RS+$  and  $RS-$  draw less than  $0.1\text{nA}$  (typ) leakage current to reduce battery load. The MAX9934 is robust and protected from input faults of up to  $\pm 6\text{V}$  input differential voltage between  $RS+$  and  $RS-$ .

The MAX9934 is specified for operation over the  $-40^\circ\text{C}$  to  $+125^\circ\text{C}$  temperature range and is available in an 8-pin  $\mu\text{MAX}^{\text{®}}$  or a 6-bump UCSP<sup>™</sup> ( $1\text{mm} \times 1.5\text{mm} \times 0.6\text{mm}$ ), making it ideal for space-sensitive applications.

## Applications

PDA's and Smartphones  
MP3 Players  
Sensor Instrumentation Amplifiers  
Notebook PCs and Ultra-Mobile PCs  
Portable Current Monitoring

$\mu\text{MAX}$  is a registered trademark and UCSP is a trademark of Maxim Integrated Products, Inc.

## Features

- ◆ Input Offset Voltage:  $10\mu\text{V}$  (max)
- ◆ Gain Error Less than  $0.25\%$
- ◆  $-0.1\text{V}$  to  $+5.5\text{V}$  Input Common-Mode Voltage Range
- ◆ Chip Select Allows Multiplexing Several MAX9934 Current Monitors to One ADC
- ◆ Current Output Allows  $R_{OUT}$  Selection for Gain Flexibility
- ◆ Single Supply Operation:  $2.5\text{V}$  to  $3.6\text{V}$
- ◆ Two Gain Options:  $G_M$  of  $25\mu\text{A}/\text{mV}$  (MAX9934T) and  $5\mu\text{A}/\text{mV}$  (MAX9934F)
- ◆ Bidirectional or Unidirectional Operation
- ◆ Small, 6-Bump UCSP ( $1\text{mm} \times 1.5\text{mm} \times 0.6\text{mm}$ ) and 8-Pin  $\mu\text{MAX}$  Packages

## Ordering Information

PART	GAIN	PIN-PACKAGE	TOP MARK
MAX9934FART+T	$5\mu\text{A}/\text{mV}$	6 UCSP	AAG
MAX9934FAUA+T	$5\mu\text{A}/\text{mV}$	8 $\mu\text{MAX}$	—
MAX9934TART+T	$25\mu\text{A}/\text{mV}$	6 UCSP	AAF
MAX9934TAUA+T	$25\mu\text{A}/\text{mV}$	8 $\mu\text{MAX}$	—

**Note:** All devices are specified over the  $-40^\circ\text{C}$  to  $+125^\circ\text{C}$  extended temperature range.

+ Denotes a lead(Pb)-free/RoHS-compliant package.

T = Tape and reel.

## Typical Operating Circuit

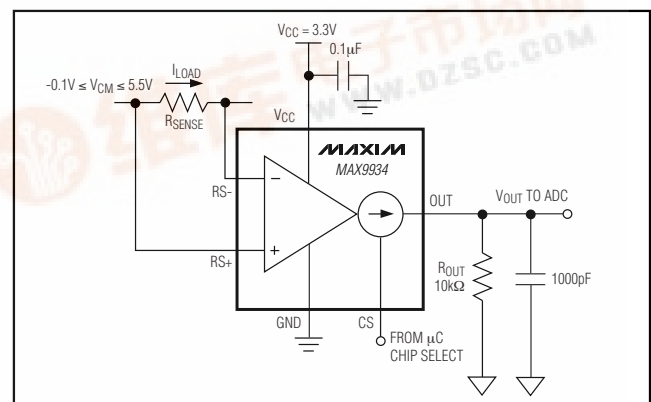

# High-Precision, Low-Voltage, Current-Sense Amplifier with Current Output and Chip Select for Multiplexing

MAX9934

## ABSOLUTE MAXIMUM RATINGS

RS+, RS- to GND.....	-0.3V to +6V	Junction-to-Case Thermal Resistance ( $\theta_{JC}$ ) (Note 1) .....	42°C/W
V <sub>CC</sub> to GND .....	-0.3V to +4V	6-Bump UCSP (derate multilayer 3.9mW/°C above +70°C).....	308mW
CS, OUT to GND (V <sub>CC</sub> = 0, or CS < V <sub>IL</sub> ).....	-0.3V to +4V	Junction-to-Ambient Thermal Resistance ( $\theta_{JA}$ ) (Note 1) .....	260°C/W
OUT to GND (CS > V <sub>IH</sub> ).....	-0.3V to V <sub>CC</sub> + 0.3V	Operating Temperature Range .....	-40°C to +125°C
Differential Input Voltage (RS+ - RS-) .....	±6V	Junction Temperature .....	+150°C
Output Short-Circuit Current Duration	Continuous	Storage Temperature Range .....	-65°C to +160°C
OUT to GND or V <sub>CC</sub> .....	Continuous	Lead Temperature ( $\mu$ MAX only, soldering, 10s).....	+300°C
Continuous Input Current into Any Terminal.....	±20mA	Soldering Temperature (reflow) .....	+260°C
Continuous Power Dissipation (T <sub>A</sub> = +70°C)			
8-Pin $\mu$ MAX (derate multilayer 4.8mW/°C above +70°C).....	388mW		
Junction-to-Ambient Thermal Resistance ( $\theta_{JA}$ ) (Note 1) .....	206°C/W		

**Note 1:** Package thermal resistances were obtained using the method described in JEDEC specification JESD51-7, using a four-layer board. For detailed information on package thermal considerations, refer to [www.maxim-ic.com/thermal-tutorial](http://www.maxim-ic.com/thermal-tutorial).

Stresses beyond those listed under "Absolute Maximum Ratings" may cause permanent damage to the device. These are stress ratings only, and functional operation of the device at these or any other conditions beyond those indicated in the operational sections of the specifications is not implied. Exposure to absolute maximum rating conditions for extended periods may affect device reliability.

## ELECTRICAL CHARACTERISTICS

(V<sub>CC</sub> = 3.3V, V<sub>RS+</sub> = V<sub>RS-</sub> = 3.0V, V<sub>SENSE</sub> = 0V, V<sub>CM</sub> = (V<sub>RS+</sub> + V<sub>RS-</sub>)/2, V<sub>CS</sub> = 3.3V, R<sub>OUT</sub> = 10k $\Omega$  to GND for unidirectional operation, R<sub>OUT</sub> = 10k $\Omega$  to V<sub>CC</sub>/2 for bidirectional operation. T<sub>A</sub> = -40°C to +125°C, unless otherwise noted. Typical values are at T<sub>A</sub> = +25°C.) (Note 2)

PARAMETER	SYMBOL	CONDITIONS	MIN	TYP	MAX	UNITS
<b>DC CHARACTERISTICS</b>						
Input Offset Voltage (Note 3)	V <sub>OS</sub>	MAX9934T	T <sub>A</sub> = +25°C		±10	$\mu$ V
			-40°C ≤ T <sub>A</sub> ≤ +125°C		±14	
		MAX9934F	T <sub>A</sub> = +25°C		±10	
			-40°C ≤ T <sub>A</sub> ≤ +125°C		±20	
Input Offset Voltage Drift (Note 3)	V <sub>OS</sub> /dT	MAX9934T			±60	nV/°C
		MAX9934F			±90	
Common-Mode Input Voltage Range (Average of V <sub>RS+</sub> and V <sub>RS-</sub> ) (Note 3)	CMVR	Guaranteed by CMRR2	-0.1		+5.5	V
Common-Mode Rejection Ratio (Note 3)	CMRR1	0 ≤ V <sub>CM</sub> ≤ V <sub>CC</sub> - 0.2V (MAX9934F)	T <sub>A</sub> = +25°C	128	134	dB
			-40°C ≤ T <sub>A</sub> ≤ +125°C	112		
		0 ≤ V <sub>CM</sub> ≤ V <sub>CC</sub> - 0.2V (MAX9934T)	T <sub>A</sub> = +25°C	128	135	
			-40°C ≤ T <sub>A</sub> ≤ +125°C	109		
	CMRR2	-0.1 ≤ V <sub>CM</sub> ≤ 5.5V (MAX9934F)	T <sub>A</sub> = +25°C	119	125	
			-40°C ≤ T <sub>A</sub> ≤ +125°C	104		
-0.1 ≤ V <sub>CM</sub> ≤ 5.5V (MAX9934T)	T <sub>A</sub> = +25°C	98	113			
	-40°C ≤ T <sub>A</sub> ≤ +125°C	98				

# High-Precision, Low-Voltage, Current-Sense Amplifier with Current Output and Chip Select for Multiplexing

## ELECTRICAL CHARACTERISTICS (continued)

( $V_{CC} = 3.3V$ ,  $V_{RS+} = V_{RS-} = 3.0V$ ,  $V_{SENSE} = 0V$ ,  $V_{CM} = (V_{RS+} + V_{RS-})/2$ ,  $V_{CS} = 3.3V$ ,  $R_{OUT} = 10k\Omega$  to GND for unidirectional operation,  $R_{OUT} = 10k\Omega$  to  $V_{CC}/2$  for bidirectional operation.  $T_A = -40^{\circ}C$  to  $+125^{\circ}C$ , unless otherwise noted. Typical values are at  $T_A = +25^{\circ}C$ .) (Note 2)

PARAMETER	SYMBOL	CONDITIONS		MIN	TYP	MAX	UNITS
Current Gain (Transconductance)	$G_M$	MAX9934T		25			$\mu A/mV$
		MAX9934F		5			
Current Gain Error (Note 4)	$G_{ME}$	MAX9934T	$T_A = +25^{\circ}C$	$\pm 0.25$			%
			$-40^{\circ}C \leq T_A \leq +125^{\circ}C$	$\pm 2.0$			
		MAX9934F	$T_A = +25^{\circ}C$	$\pm 0.25$			
			$-40^{\circ}C \leq T_A \leq +125^{\circ}C$	$\pm 2.4$			
Gain Error Drift	$G_{ME}/dT$	MAX9934T		$\pm 200$			ppm/ $^{\circ}C$
		MAX9934F		$\pm 240$			
Input-Bias Current for RS+	$I_{BRS+}$	$V_{RS+} = V_{RS-} = 5.5V$			0.1	100	nA
Input-Bias Current for RS-	$I_{BRS-}$	$V_{RS+} = V_{RS-} \leq V_{CC} - 0.2V$			0.1	100	nA
		$V_{RS+} = V_{RS-} = 5.5V$			35	60	$\mu A$
Input Leakage Current	$I_{LEK}$	$V_{CC} = 0V$ , $V_{RS+} = V_{RS-} = 5.5V$			0.1	100	nA
<b>DC CHARACTERISTICS</b>							
Minimum Current for Output Low	$I_{OL}$	Unidirectional, $V_{OL} = I_{OL} \times R_{OUT}$			1	100	nA
Output-Voltage Range (MAX9934T)	$V_{OH}$	$I_{OUT} = +600\mu A$ , $V_{OH} = V_{CC} - V_{OUT}$			0.1	0.25	V
	$V_{OL}$	$I_{OUT} = -600\mu A$ , bidirectional			0.15	0.25	
Output-Voltage Range (MAX9934F)	$V_{OH}$	$I_{OUT} = +375\mu A$ , $V_{OH} = V_{CC} - V_{OUT}$			0.18	0.30	V
	$V_{OL}$	$I_{OUT} = -375\mu A$ , bidirectional			0.18	0.26	
Deselected Amplifier Output Leakage	$I_{OLK}$	$V_{CS} = 0V$ , $V_{OUT} = 3.6V$ , and $0 \leq V_{CC} \leq 3.6V$			0.1	100	nA
<b>LOGIC I/O (CS)</b>							
Input Voltage Low CS	$V_{IL}$			0.54			V
Input Voltage High CS	$V_{IH}$				1.26		V
Input Current CS	$I_{IL}, I_{IH}$	$0 \leq V_{CS} \leq V_{CC}$			0.1	100	nA
<b>POWER SUPPLY</b>							
Supply-Voltage Range	$V_{CC}$	Guaranteed by PSRR		2.5	3.6		V
Power-Supply Rejection Ratio	PSRR	$2.5V \leq V_{CC} \leq 3.6V$ , $V_{RS+} = V_{RS-} = 2V$ (Note 3)		110	120		dB
Supply Current	$I_{CC}$	$V_{CC} = 3.3V$ , $R_{OUT} = 10k\Omega$ to $3.3V$ , $V_{RS+} = V_{RS-} = 3.1V$			120	230	$\mu A$
Supply Current, Output Deselected	$I_{CC,DES}$	$V_{CS} = 0V$ , $R_{OUT} = 10k\Omega$ to $3.3V$ , $V_{RS+} = V_{RS-} = 3.1V$			120	210	$\mu A$
<b>AC CHARACTERISTICS (<math>C_L = 1000pF</math>)</b>							
Amplifier Bandwidth	BW	MAX9934T $G_M = 25\mu A/mV$ , $V_{SENSE} = 5mV$		1.5			kHz
		MAX9934F $G_M = 5\mu A/mV$ , $V_{SENSE} = 25mV$		5			

# High-Precision, Low-Voltage, Current-Sense Amplifier with Current Output and Chip Select for Multiplexing

MAX9934

## ELECTRICAL CHARACTERISTICS (continued)

( $V_{CC} = 3.3V$ ,  $V_{RS+} = V_{RS-} = 3.0V$ ,  $V_{SENSE} = 0V$ ,  $V_{CM} = (V_{RS+} + V_{RS-})/2$ ,  $V_{CS} = 3.3V$ ,  $R_{OUT} = 10k\Omega$  to GND for unidirectional operation,  $R_{OUT} = 10k\Omega$  to  $V_{CC}/2$  for bidirectional operation.  $T_A = -40^{\circ}C$  to  $+125^{\circ}C$ , unless otherwise noted. Typical values are at  $T_A = +25^{\circ}C$ .) (Note 2)

PARAMETER	SYMBOL	CONDITIONS	MIN	TYP	MAX	UNITS
Output Settling Time	$t_S$	0.1% final value, Figure 1, MAX9934T		670		$\mu s$
		0.1% final value, Figure 1, MAX9934F		220		
Output Select Time	$t_{ZH}$	Output to 0.1% final value, Figure 2, MAX9934T		150		$\mu s$
		Output to 0.1% final value, Figure 2, MAX9934F		80		
Output Deselect Time	$t_{HZ}$	Output step of 100mV, $C_L = 10pF$ , Figure 2		2		$\mu s$
Power-Down Time	$t_{PD}$	Output step of -100mV, $C_L = 10pF$ , $V_{CC} > 2.5V$		2		$\mu s$
Power-Up Time	$t_{PU}$	0.1% final value, Figure 3, MAX9934T		300		$\mu s$
		0.1% final value, Figure 3, MAX9934F		200		

**Note 2:** All devices are 100% production tested at  $T_A = +25^{\circ}C$ . Unless otherwise noted, specifications overtemperature are guaranteed by design.

**Note 3:** Guaranteed by design. Thermocouple, contact resistance,  $R_S$ - input-bias current, and leakage effects preclude measurement of this parameter during production testing. Devices are screened during production testing to eliminate defective units.

**Note 4:** Gain error tested in unidirectional mode:  $0.2V \leq V_{OUT} \leq 3.1V$  for the MAX9934T;  $0.25V \leq V_{OUT} \leq 2.5V$  for the MAX9934F.

# High-Precision, Low-Voltage, Current-Sense Amplifier with Current Output and Chip Select for Multiplexing

## Typical Operating Characteristics

( $V_{CC} = 3.3V$ ,  $V_{RS+} = V_{RS-} = 3.0V$ ,  $V_{SENSE} = 0V$ ,  $C_L = 1000pF$ ,  $R_{OUT} = 10k\Omega$  to GND for unidirectional operation,  $R_{OUT} = 10k\Omega$  to  $V_{CC}/2$  for bidirectional operation.  $T_A = +25^\circ C$ , unless otherwise noted.)

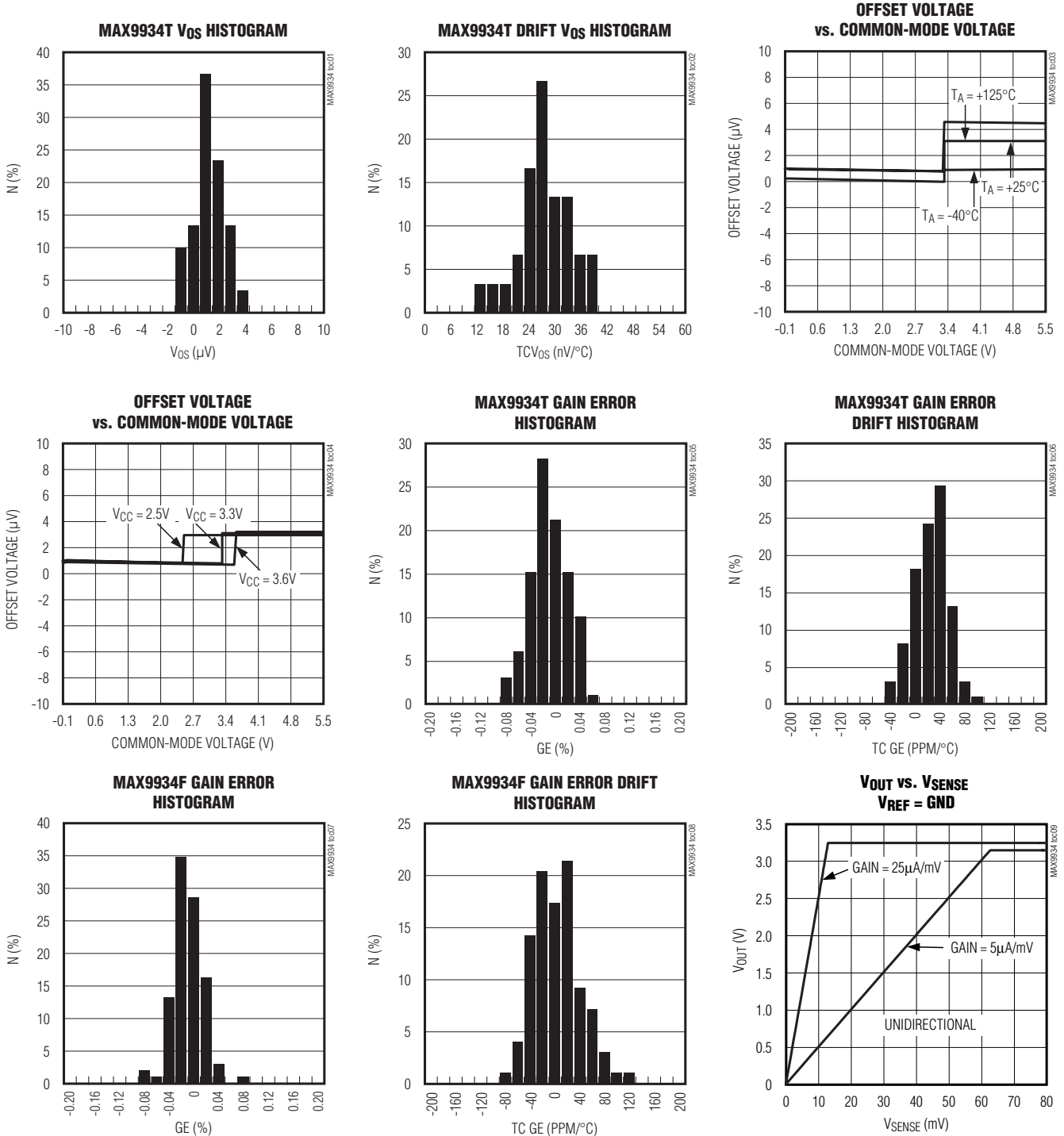

[查询"MAX9934"供应商](#)

# High-Precision, Low-Voltage, Current-Sense Amplifier with Current Output and Chip Select for Multiplexing

## Typical Operating Characteristics (continued)

( $V_{CC} = 3.3V$ ,  $V_{RS+} = V_{RS-} = 3.0V$ ,  $V_{SENSE} = 0V$ ,  $C_L = 1000pF$ ,  $R_{OUT} = 10k\Omega$  to GND for unidirectional operation,  $R_{OUT} = 10k\Omega$  to  $V_{CC}/2$  for bidirectional operation.  $T_A = +25^\circ C$ , unless otherwise noted.)

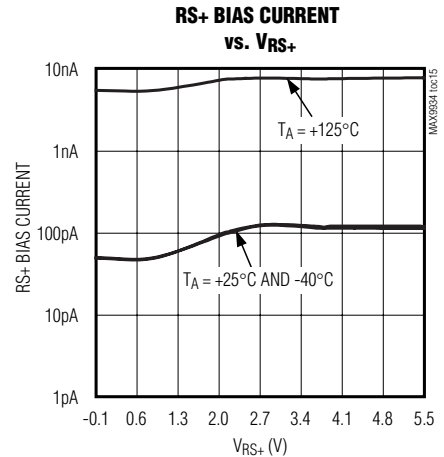
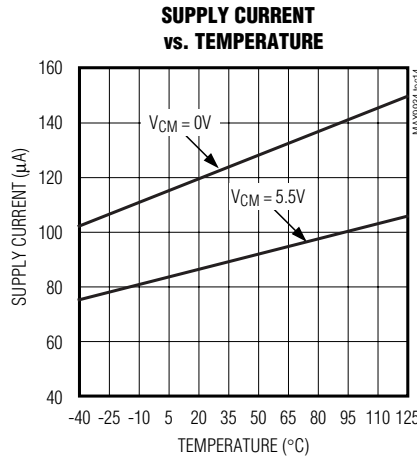
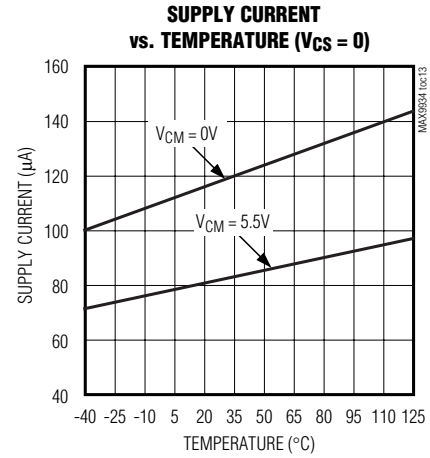
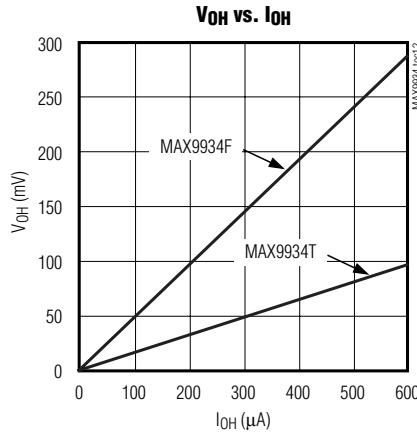
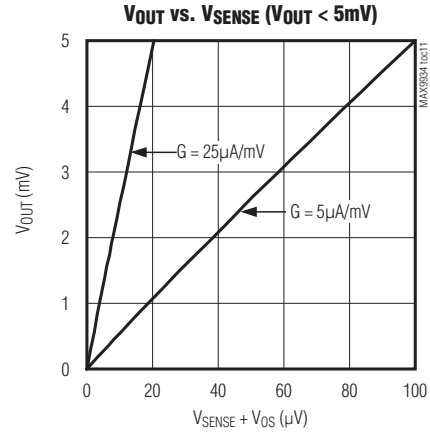
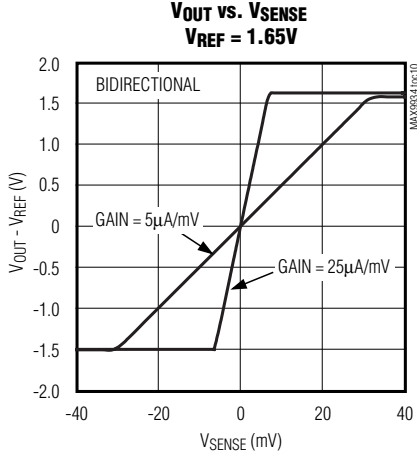

# High-Precision, Low-Voltage, Current-Sense Amplifier with Current Output and Chip Select for Multiplexing

## Typical Operating Characteristics (continued)

( $V_{CC} = 3.3V$ ,  $V_{RS+} = V_{RS-} = 3.0V$ ,  $V_{SENSE} = 0V$ ,  $C_L = 1000pF$ ,  $R_{OUT} = 10k\Omega$  to GND for unidirectional operation,  $R_{OUT} = 10k\Omega$  to  $V_{CC}/2$  for bidirectional operation.  $T_A = +25^\circ C$ , unless otherwise noted.)

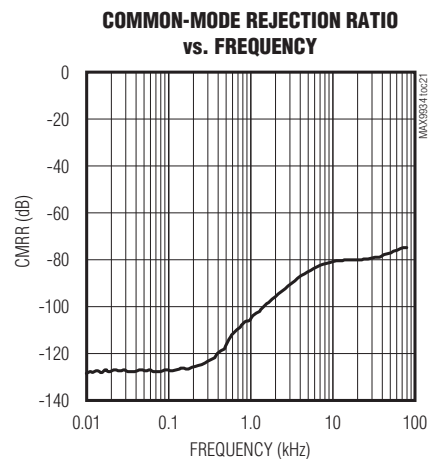
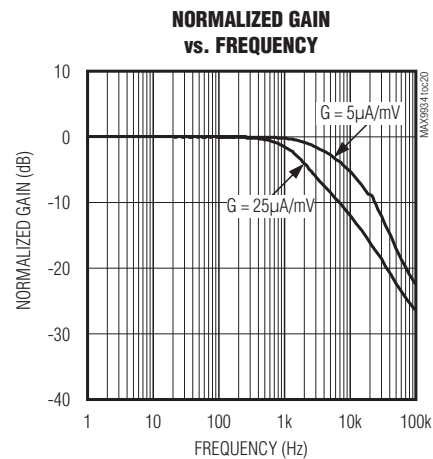
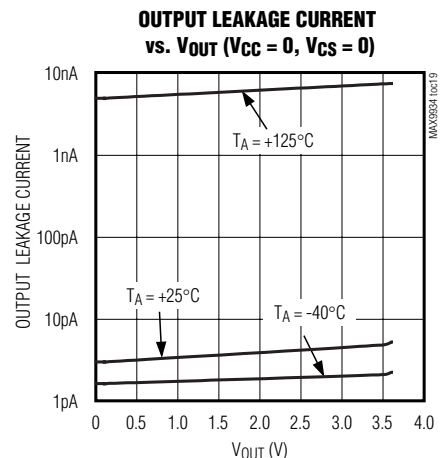
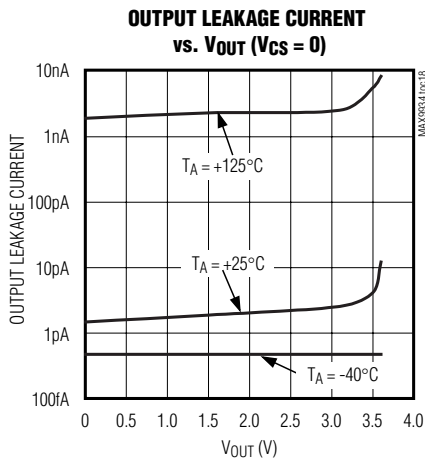
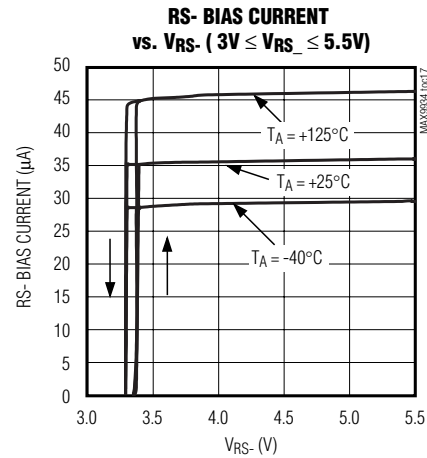
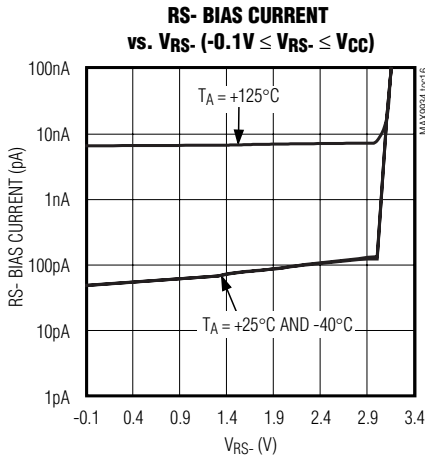

[查询"MAX9934"供应商](#)

# High-Precision, Low-Voltage, Current-Sense Amplifier with Current Output and Chip Select for Multiplexing

## Typical Operating Characteristics (continued)

( $V_{CC} = 3.3V$ ,  $V_{RS+} = V_{RS-} = 3.0V$ ,  $V_{SENSE} = 0V$ ,  $C_L = 1000pF$ ,  $R_{OUT} = 10k\Omega$  to GND for unidirectional operation,  $R_{OUT} = 10k\Omega$  to  $V_{CC}/2$  for bidirectional operation.  $T_A = +25^\circ C$ , unless otherwise noted.)

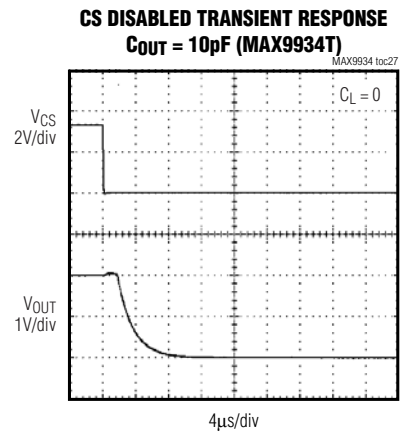
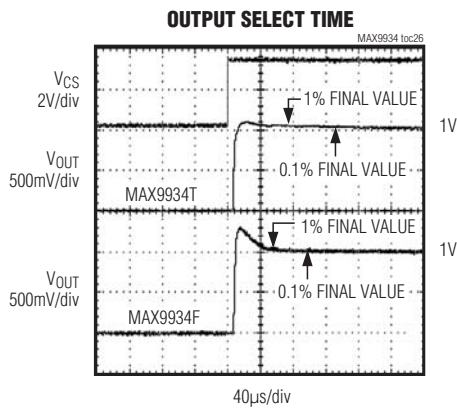
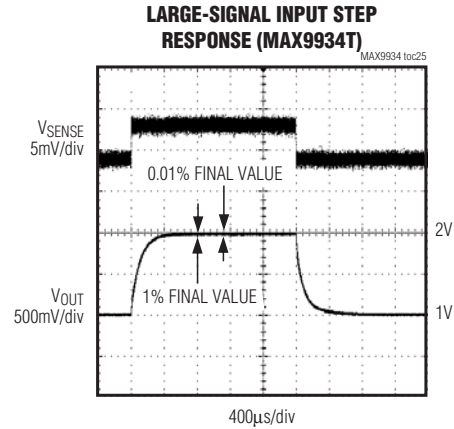
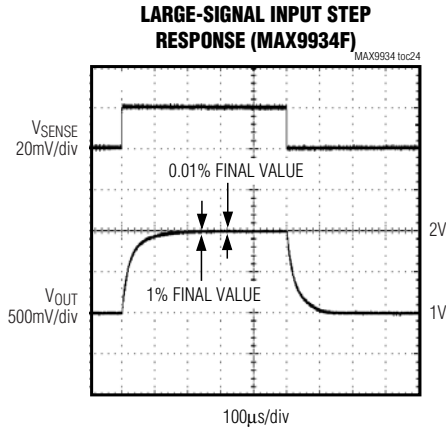
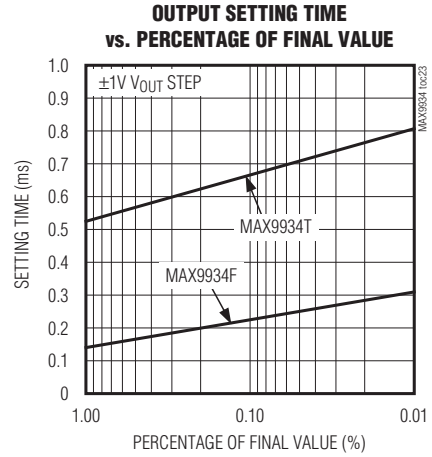
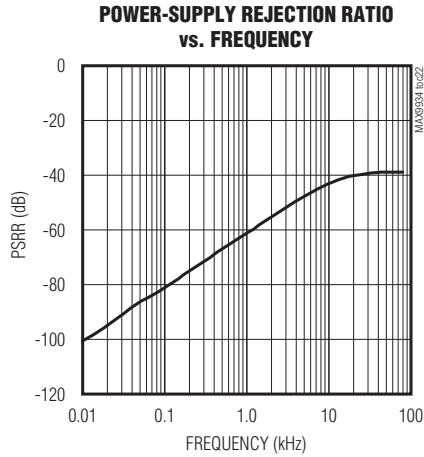



# High-Precision, Low-Voltage, Current-Sense Amplifier with Current Output and Chip Select for Multiplexing

## Typical Operating Characteristics (continued)

( $V_{CC} = 3.3V$ ,  $V_{RS+} = V_{RS-} = 3.0V$ ,  $V_{SENSE} = 0V$ ,  $C_L = 1000pF$ ,  $R_{OUT} = 10k\Omega$  to GND for unidirectional operation,  $R_{OUT} = 10k\Omega$  to  $V_{CC}/2$  for bidirectional operation.  $T_A = +25^\circ C$ , unless otherwise noted.)

MAX9934

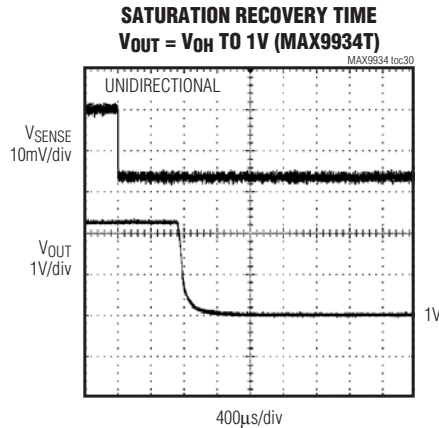
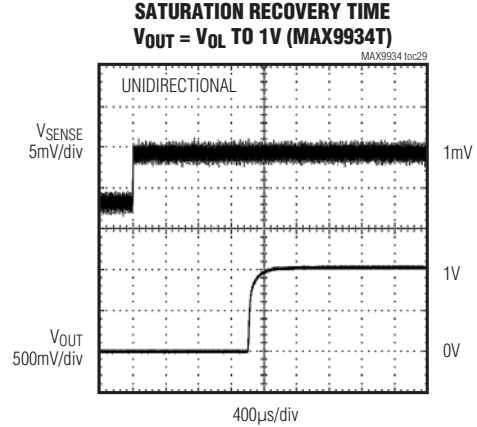
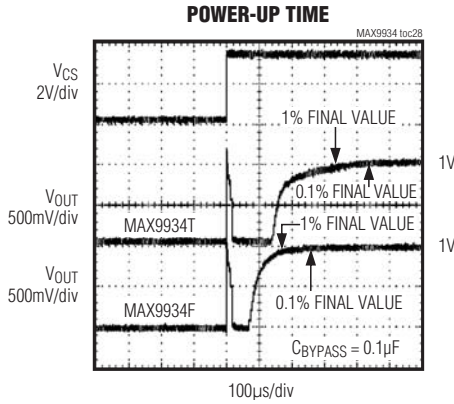

# High-Precision, Low-Voltage, Current-Sense Amplifier with Current Output and Chip Select for Multiplexing

## Pin Description

PIN/BUMP		NAME	FUNCTION
UCSP	μMAX		
A1	1	VCC	Power Supply
A2	2	OUT	Current Output. OUT provides an output current proportional to input V <sub>SENSE</sub> . Connect an external resistor (R <sub>OUT</sub> ) from OUT to GND for unidirectional sensing or to an external reference voltage for bidirectional sensing.
A3	3	GND	Ground
B1	8	RS+	Sense Resistor Power Side Connection
B2	7	RS-	Sense Resistor Load Side Connection
B3	6	CS	Chip-Select Input. Drive CS high to enable OUT, drive CS low to put OUT in a high-impedance state.
—	4, 5	N.C.	No Connection. Not internally connected.

## Functional Diagram

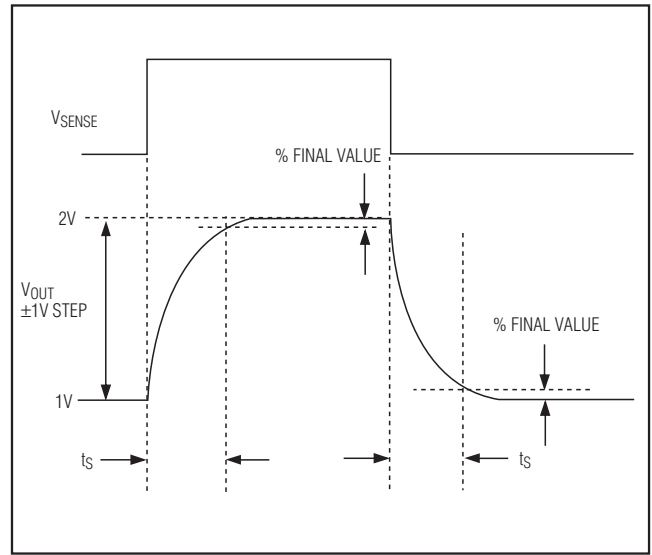
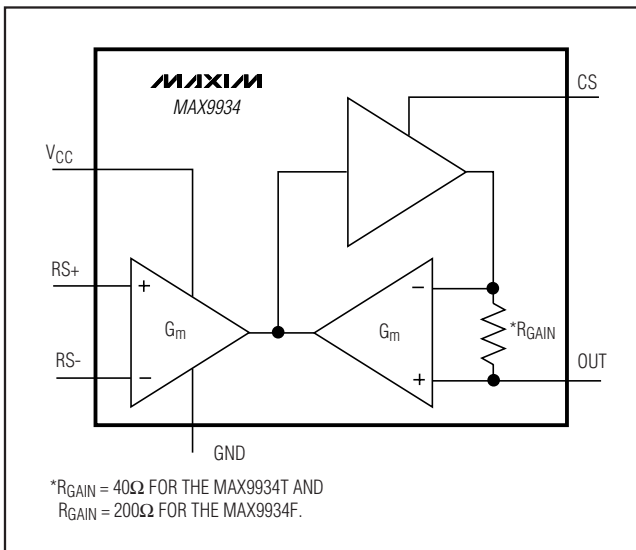

Figure 1. Output Settling Time

## Detailed Description

The MAX9934 high-side, current-sense amplifier monitors current through an external current-sense resistor by amplifying the voltage across the resistor (V<sub>SENSE</sub>) to create an output current (I<sub>OUT</sub>). An output voltage (V<sub>OUT</sub>) then develops across the external output resistor (R<sub>OUT</sub>). See the *Typical Operating Circuit*.

The MAX9934 uses precision amplifier design techniques to achieve a low-input offset voltage of less than 10μV. These techniques also enable extremely low-input offset voltage drift over time and temperature and

achieve gain error of less than 0.25%. The precision V<sub>OS</sub> specification allows accurate current measurements with a low-value current-sense resistor, thus reducing power dissipation in battery-powered systems, as well as load-regulation issues in low-voltage DC power supplies.

The MAX9934 high-side current-sense amplifier features a -0.1V to +5.5V input common-mode range that is independent of supply voltage (V<sub>CC</sub>). This ability to sense at voltages beyond the supply rail allows the monitoring of currents out of a power supply even in a shorted condition, while also enabling high-side current sensing at voltages greater than the MAX9934 supply

# High-Precision, Low-Voltage, Current-Sense Amplifier with Current Output and Chip Select for Multiplexing

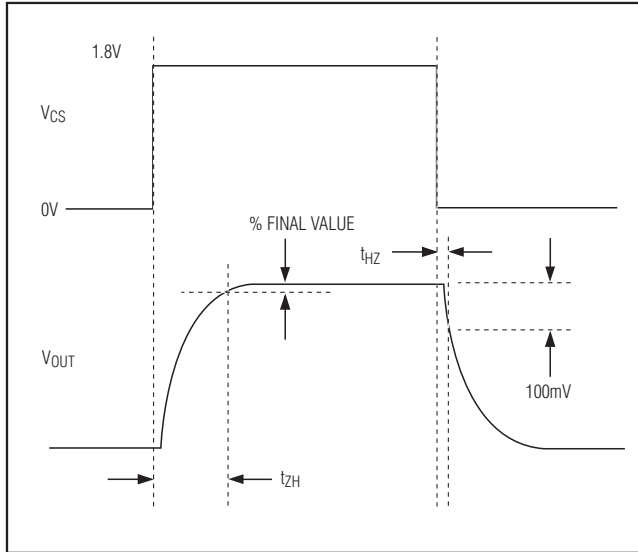

Figure 2. Output Select and Deselect Time

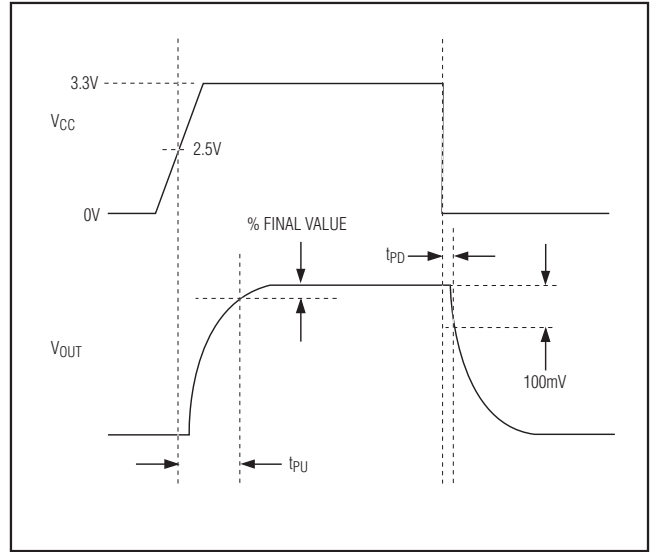

Figure 3. Output Power-Up and Power-Down Time

voltage. Further, when  $V_{CC} = 0$ , the amplifier maintains an extremely high impedance on both its inputs and output, up to the maximum operating voltages (see the *Absolute Maximum Ratings* section).

The MAX9934 features a CS that can be used to deselect its output current-source. This allows multiple current-sense amplifier outputs to be multiplexed into a single ADC channel with a single  $R_{OUT}$ . See the *Chip Select Functionality for Multiplexed Systems* section for more details.

The *Functional Diagram* shows the internal operation of the MAX9934. At its core is the indirect current-feedback architecture. This architecture uses two matched transconductance amplifiers to convert their input differential voltages into an output current. A high-gain feedback amplifier forces the voltage drop across  $R_{GAIN}$  to be the same as the input differential voltage. The internal resistor ( $R_{GAIN}$ ) sets the transconductance gain of the device. Both input and output transconductance amplifiers feature excellent common-mode rejection characteristics, helping the MAX9934 to deliver industry-leading precision specifications over the full common-mode range.

## Applications Information

### Advantages of Current-Output Architecture

The transconductance transfer function of the MAX9934 converts input differential voltage to an output current. An output termination resistor,  $R_{OUT}$ , then converts this current to a voltage. In a large circuit board with multiple ground planes and multiple current-measurement rails spread across the board, traditional voltage-output current-sense amplifiers become susceptible to ground-bounce errors. These errors occur because the local ground at the location of the current-sense amplifier is at a slightly different voltage than the local ground voltage at the ADC that is sampling the voltage. The MAX9934 allows accurate measurements to be made even in the presence of system ground noise. This is achieved by sending the output information as a current, and by terminating to the ADC ground.

A further advantage of current-output systems is the flexibility in setting final voltage gain of the device. Since the final voltage gain is user-controlled by the choice of output termination resistor, it is easy to optimize the monitored load current range to the ADC input voltage range. It is no longer necessary to increase the size of the sense resistor (also increasing power dissipation) as necessary with fixed-gain, voltage-output current-sense amplifiers.

# High-Precision, Low-Voltage, Current-Sense Amplifier with Current Output and Chip Select for Multiplexing

MAX9934

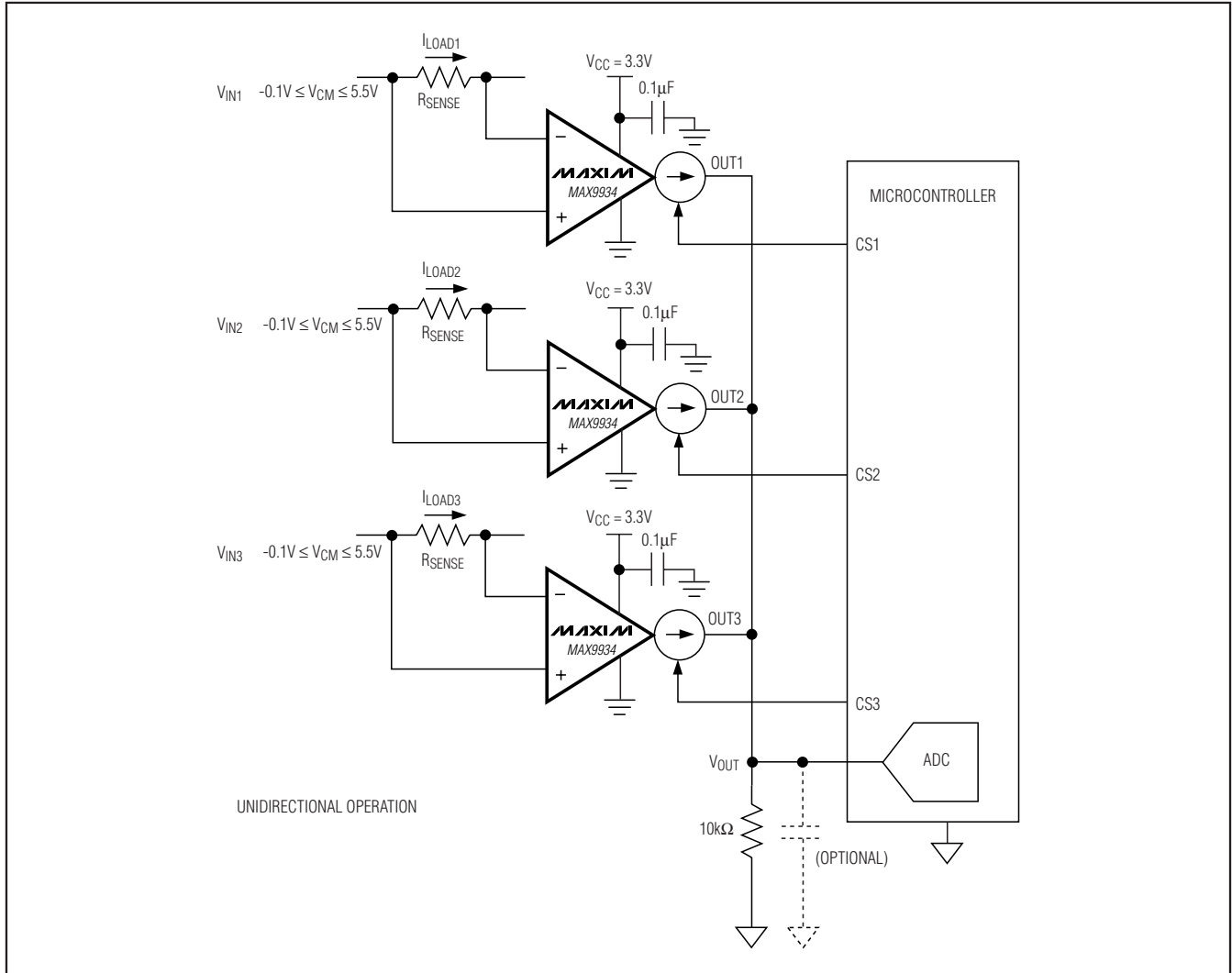

Figure 4. Typical Application Circuit Showing Chip-Select Multiplexing

### Chip-Select Functionality for Multiplexed Systems

The MAX9934 features a CS that can be used to deselect the output current - source achieving a high-impedance output with 0.1nA leakage current. Thus, different supply voltages can be used to power different MAX9934 devices that are multiplexed on the same bus. This technique makes it possible for advanced current monitoring and power-management schemes to be implemented when a limited number of ADC channels are available.

In a multiplexed arrangement, each MAX9934 is typically placed near the load being monitored and all

amplifier outputs are connected in common to a single load resistor located adjacent to the monitoring ADC. This resistor is terminated to the ADC ground reference as shown in Figure 4 for unidirectional applications.

Figure 5 shows a bidirectional multiplexed application. Terminating the external resistor at the ground reference of the ADC minimizes errors due to ground shift as discussed in the *Advantages of Current-Output Architecture* section.

The MAX9934 is capable of both sourcing and sinking current from OUT, and thus can be used as a precision bidirectional current-sense amplifier. To enable this functionality, terminate  $R_{OUT}$  to a midrail voltage  $V_{BIAS}$ .

# High-Precision, Low-Voltage, Current-Sense Amplifier with Current Output and Chip Select for Multiplexing

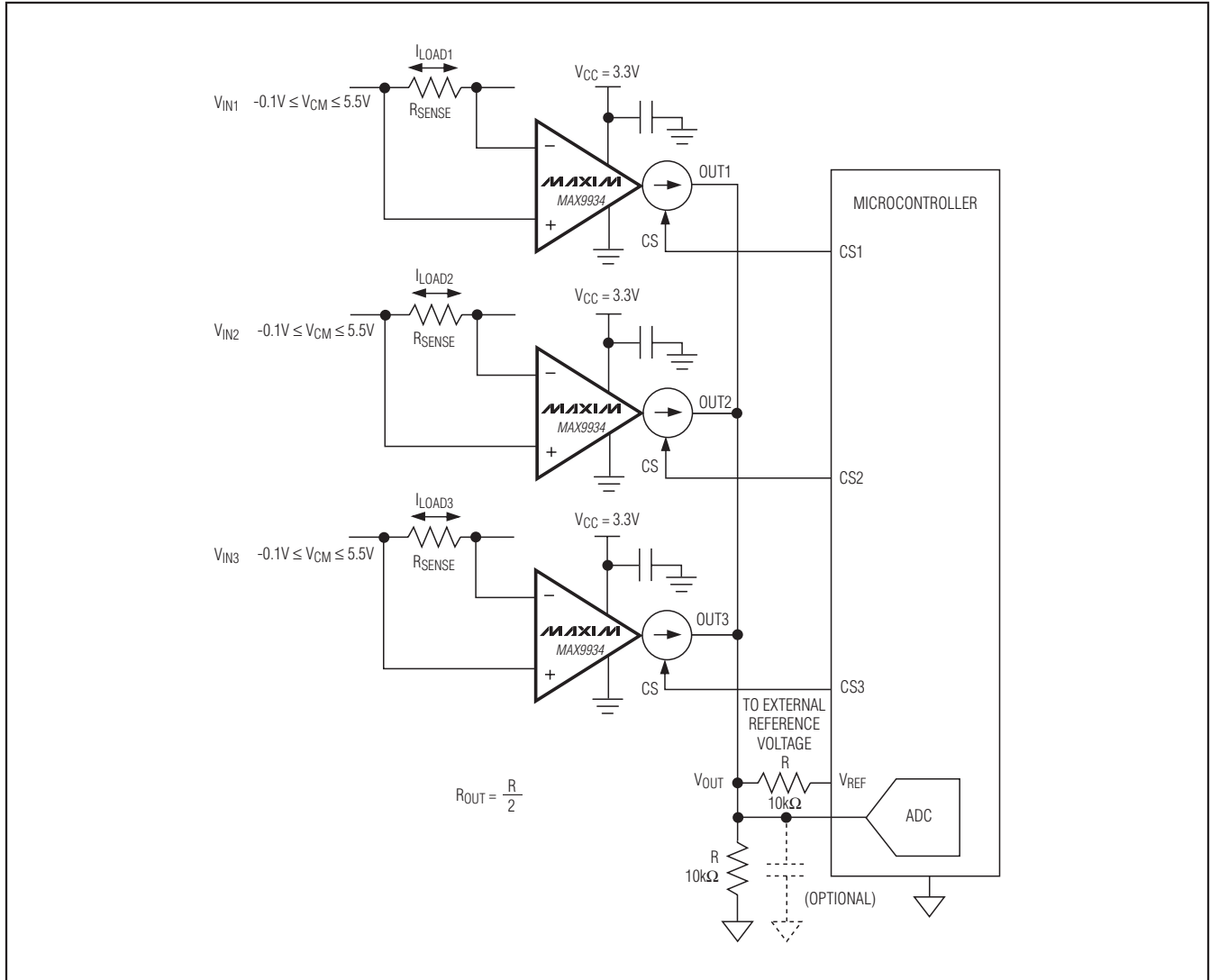

Figure 5. Bidirectional Multiplexed Operation

In Figure 5,  $V_{OUT}$  is equal to  $V_{BIAS}$  when the sum of all outputs is zero. For positive input-sense voltages, the MAX9934 sources current causing its output voltage to rise above  $V_{BIAS}$ . For negative input-sense voltages, the MAX9934 sinks current causing its output voltage to be lower than  $V_{BIAS}$ , thus allowing bidirectional current sensing.

Since the ADC reference voltage,  $V_{REF}$ , determines the full-scale reading, a common choice for  $V_{BIAS}$  is  $V_{REF}/2$ . The current output makes it possible to use a simple resistor-divider from  $V_{REF}$  to GND to generate  $V_{BIAS}$ . The output resistance for gain calculation is the parallel combination of the two resistors. For example, if two equal value resistors,  $R$ , are used to generate a  $V_{BIAS} = V_{REF}/2$ , the output termination resistance for gain calculation is  $R_{OUT} = R/2$ . See Figure 5.

# High-Precision, Low-Voltage, Current-Sense Amplifier with Current Output and Chip Select for Multiplexing

MAX9934

A MAX9934 can be deselected by either forcing  $V_{CS}$  low as shown in Figures 4 and 5, or by making  $V_{CC} = 0V$  as shown in Figure 6. In all these conditions, the MAX9934 maintains a high-impedance output with 0.1nA (typ) leakage current. In this state, OUT can rise above  $V_{CC}$  if necessary. Thus, different supply voltages can be used to power different MAX9934 devices that are multiplexed on the same OUT bus. Multiplexing by forcing the MAX9934 to be powered down ( $V_{CC} = 0V$ ) reduces its supply current to zero to help extend battery life in portable applications.

## Choosing $R_{SENSE}$ and $R_{OUT}$

In the current-sense application, the monitored load current ( $I_{LOAD}$ ) develops a sense voltage ( $V_{SENSE}$ ) across a current-sense resistor ( $R_{SENSE}$ ). The MAX9934 sources or sinks an output current that is proportional to  $V_{SENSE}$ . Finally, the MAX9934 output current is provided to an output resistor ( $R_{OUT}$ ) to develop an output voltage across  $R_{OUT}$  that is proportional to the sensed load current.

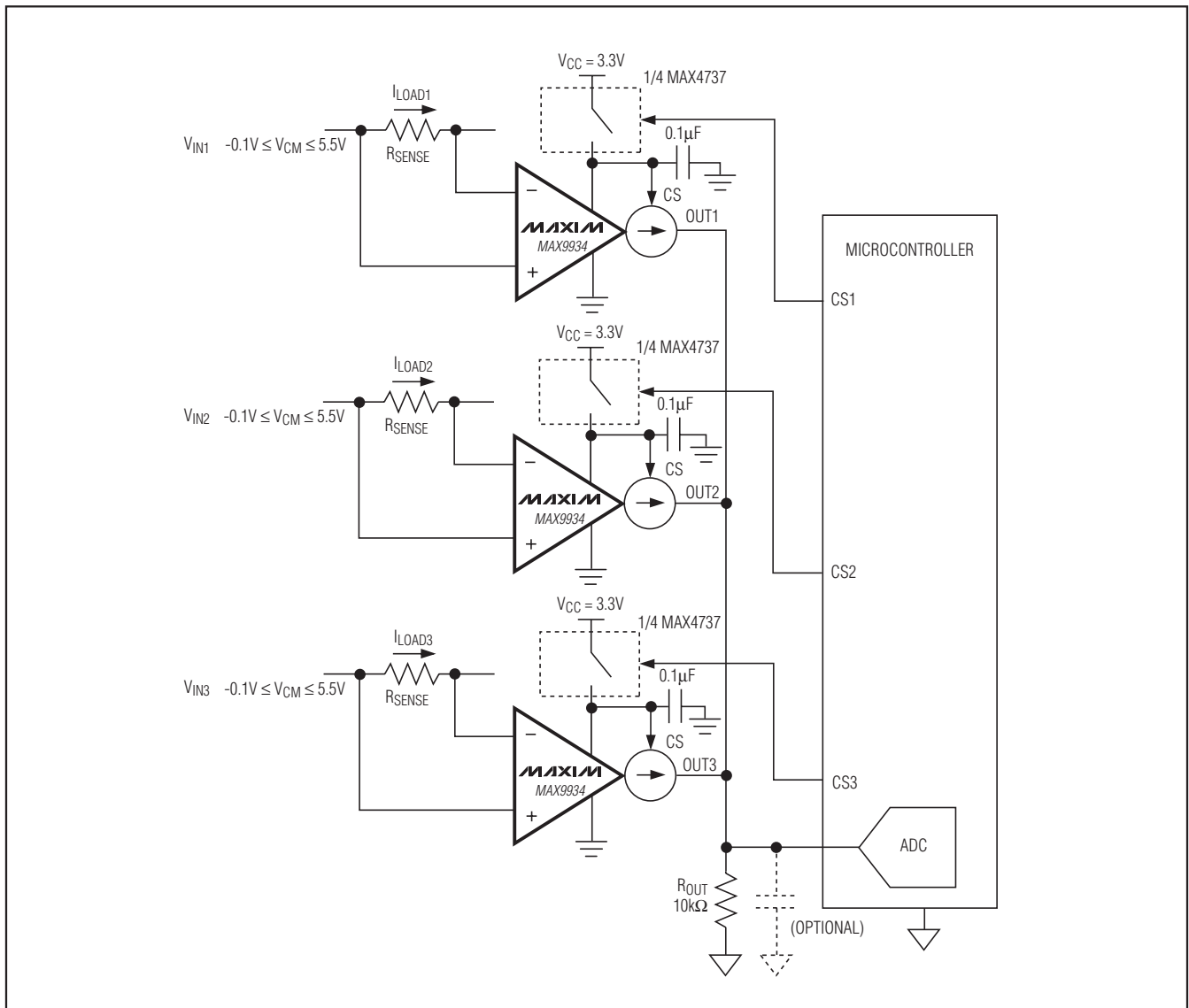

Figure 6. Multiplexed Amplifiers with Power Saving

# High-Precision, Low-Voltage, Current-Sense Amplifier with Current Output and Chip Select for Multiplexing

Three components are to be selected to optimize the current-sense system:  $R_{SENSE}$ ,  $R_{OUT}$ , and the MAX9934 gain option ( $G_M = 25\mu A/mV$  or  $5\mu A/mV$ ). Tables 1 and 2 are gain tables for unidirectional and bidirectional operation, respectively. They offer a few examples for both MAX9934 options having an output range of 3.1V unidirectional and  $\pm 1.65V$  bidirectional.

Note that the output current of the MAX9934 adds to its quiescent current. This can be calculated as follows:

$$I_{OUT,MAX} = V_{OUT,MAX}/R_{OUT}$$

When selecting  $R_{SENSE}$ , consider the expected magnitude of  $I_{LOAD}$  and the required  $V_{SENSE}$  to manage power dissipation in  $R_{SENSE}$ :

$$R_{SENSE} = V_{SENSE,MAX}/I_{LOAD,MAX}$$

$R_{SENSE}$  is typically a low-value resistor specifically designed for current-sense applications.

Finally, in selecting the appropriate MAX9934 gain option ( $G_M$ ), consider both the required  $V_{SENSE}$  and  $I_{OUT}$ :

$$G_M = I_{OUT,MAX}/V_{SENSE,MAX}$$

Once all three component values have been selected in the current-sense application, the system performance is represented by:

$$V_{SENSE} = R_{SENSE} \times I_{LOAD}$$

and

$$V_{OUT} = V_{SENSE} \times G_M \times R_{OUT}$$

## Accuracy

In a first-order analysis of accuracy there are two MAX9934 specifications that contribute to output error, input offset ( $V_{OS}$ ) and gain error (GE). The MAX9934 has a maximum  $V_{OS}$  of  $10\mu V$  and a maximum GE of 0.25%.

Note that the tolerance and temperature coefficient of the chosen resistors directly affect the precision of any measurement system.

## Efficiency and Power Dissipation

At high-current levels, the  $I^2R$  losses in  $R_{SENSE}$  can be significant. Take this into consideration when choosing the resistor value and its power dissipation (wattage) rating. Also, the sense resistor's value drifts if it is allowed to self-heat excessively. The precision  $V_{OS}$  of the MAX9934 allows the use of a small sense resistor to reduce power dissipation and eliminate hot spots.

## Kelvin Contacts

Due to the high currents that flow through  $R_{SENSE}$ , take care to prevent trace resistance in the load current path from causing errors in the sense voltage. Use a four-terminal current-sense resistor or Kelvin contacts (force and sense) PCB layout techniques.

Table 1. Unidirectional Gain Table\*

PART	$V_{SENSE}$ (mV)	OUTPUT CURRENT ( $\mu A$ )	$R_{OUT}$ (k $\Omega$ )	GAIN (V/V)
MAX9934T	12.4	310	10	250
	24.8	620	5	125
MAX9934F	62	310	10	50
	75	375	8	40

\*All calculations were made with  $V_{CC} = 3.3V$  and  $V_{OUT(MAX)} = V_{CC} - V_{OH} = 3.1V$ .

Table 2. Bidirectional Gain Table\*

PART	$V_{SENSE}$ (mV)	OUTPUT CURRENT ( $\mu A$ )	$R_{OUT}$ (k $\Omega$ )	GAIN (V/V)
MAX9934T	$\pm 5.8$	$\pm 145$	10	250
	$\pm 11.6$	$\pm 290$	5	125
	$\pm 24$	$\pm 600$	2.4	60
MAX9934F	$\pm 29$	$\pm 145$	10	50
	$\pm 58$	$\pm 290$	5	25
	$\pm 72$	$\pm 360$	4	20

\*All calculations were made with  $V_{CC} = 3.3V$ ,  $V_{OUT(MAX)} = V_{CC} - V_{OH} = 3.1V$ ,  $V_{OUT(MIN)} = V_{OL}$ , and  $OUT$  connected to an external reference voltage of  $V_{REF} = 1.65V$  through  $R_{OUT}$ .

## Interfacing the MAX9934 to SAR ADCs

Since the MAX9934 is essentially a high-output impedance current-source, its output termination resistor,  $R_{OUT}$ , acts like a source impedance when driving an ADC channel. Most successive approximation register (SAR) architecture ADCs specify a maximum source resistance to avoid compromising the accuracy of their readings. Choose the output termination resistor  $R_{OUT}$  such that it is less than that required by the ADC specification (10k $\Omega$  or less). If the  $R_{OUT}$  is larger than the source resistance specified, the ADC internal sampling capacitor can momentarily load the amplifier output and cause a drop in the voltage reading.

If  $R_{OUT}$  is larger than the source resistance specified, consider using a ceramic capacitor from ADC input to GND. This input capacitor supplies momentary charge to the internal ADC sampling capacitor, helping hold  $V_{OUT}$  constant to within  $\pm 1/2$  LSB during the acquisition period. Use of this capacitor reduces the noise in the output signal to improve sensitivity of measurement.

# High-Precision, Low-Voltage, Current-Sense Amplifier with Current Output and Chip Select for Multiplexing

MAX9934

## Effect of Input-Bias Currents

The MAX9934 has extremely low CMOS input-bias currents at both RS+ and RS- (0.1nA) when the input common-mode voltage is less than the supply voltage. When the input common-mode voltage becomes higher than the supply voltage, it draws the input stage operating current from RS-, 35µA (typ). RS+ maintains its CMOS input characteristics.

Low-input-bias currents are extremely useful in design of input filters for current-sense amplifiers. Input differential filters are sometimes required to average out rapidly varying load currents. An example of such load currents are those consumed by a processor, or switching power supply. Large bias and offset currents can interact with resistors used in these external filters to generate large input offset voltages and gain errors. For more detailed information, see Application Note AN3888: *Performance of Current-Sense Amplifiers with Input Series Resistors*.

Due to the low-input-bias currents, resistors as large as 10kΩ can be easily used without impact on error specifications with the MAX9934. For applications where the input common-mode voltage is below VCC, a balanced differential filter can be used. For applications where the input common-mode voltage extends above VCC, use a one-sided filter with a capacitor between RS+ and RS-, and a filter resistor in series with RS+ to maintain the excellent performance of the MAX9934. See Figure 7.

## PCB Layout

For applications where the input common-mode voltage extends above VCC, trace resistance between RSENSE and RS- influences the effective VOS error due to the voltage drop developed across the trace resistance by the 35µA input bias current at RS-.

## Monitoring Very Low Currents

The accuracy of the MAX9934 leads to a wide dynamic range. This applies to both unidirectional mode and bidirectional mode. This is made possible in the unidirectional mode because the output maintains gain accuracy below 1mV as shown in the VOUT vs. VSENSE (VOUT < 5mV) graph in the *Typical Operating Characteristics*. Extending the useful output below 1mV makes it possible for the MAX9934 to accurately monitor very low currents.

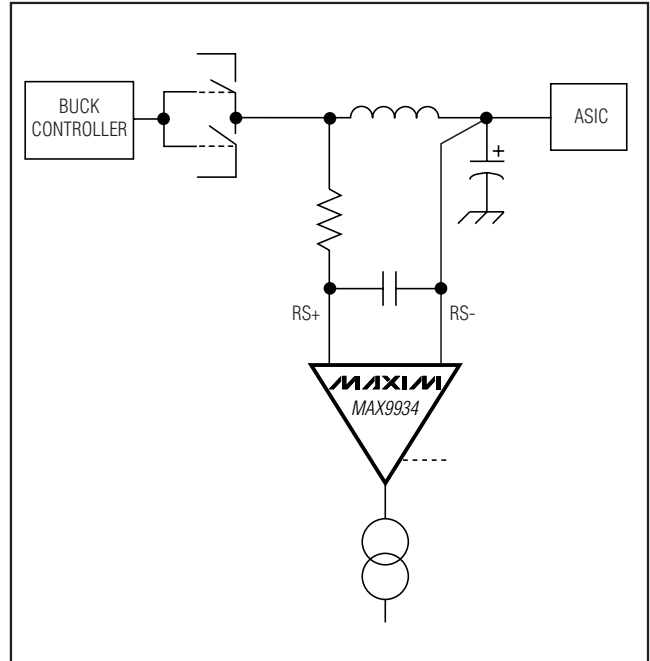

Figure 7. One-Sided Input Filter

## Use as Precision Instrumentation Amplifier

When the input common-mode voltage is below VCC, the input bias current of the RS- input drops to the 10pA range, the same range as the RS+ input. This low-input-bias current in combination with the rail-to-rail common-mode input range, the extremely high common-mode rejection, and low VOS of the MAX9934 make it ideally suited for use as a precision instrumentation amplifier. In addition, the MAX9934 is stable into an infinite capacitive load, allowing filtering flexibility.

Figure 8 shows the MAX9934 in a multiplexed arrangement of strain-gauge amplifiers.

## UCSP Applications Information

For the latest application details on UCSP construction, dimensions, tape carrier information, printed circuit board techniques, bump-pad layout, and recommended reflow temperature profile, as well as the latest information on reliability testing results go to the Maxim website at [www.maxim-ic.com/ucsp](http://www.maxim-ic.com/ucsp) for the Application Note 1891: *Understanding the Basics of the Wafer-Level Chip-Scale Package (WL-CSP)*.



# High-Precision, Low-Voltage, Current-Sense Amplifier with Current Output and Chip Select for Multiplexing

MAX9934

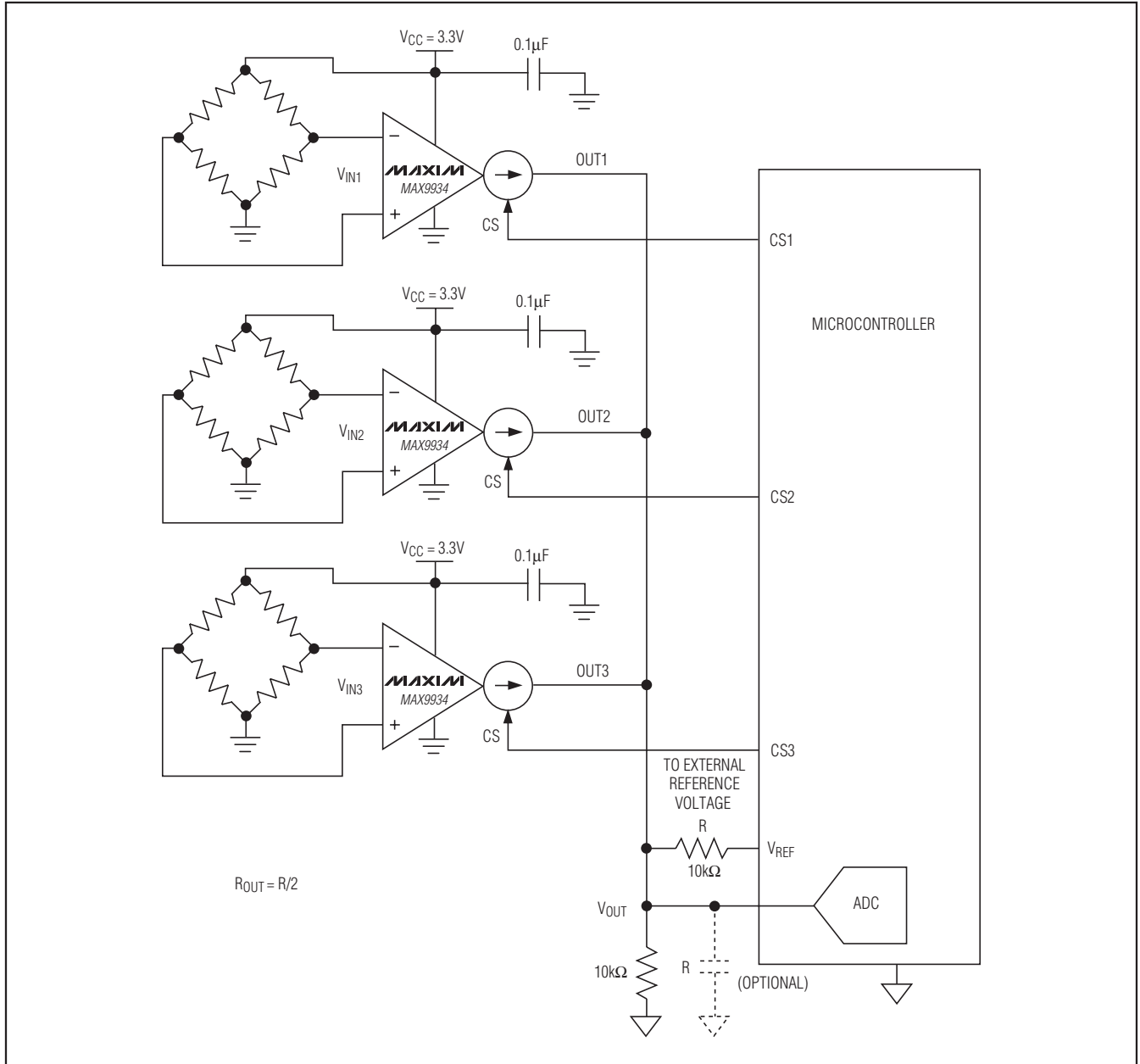

Figure 8. Multiplexed, Strain-Gauge Amplifier Operation

[查询"MAX9934"供应商](#)

# High-Precision, Low-Voltage, Current-Sense Amplifier with Current Output and Chip Select for Multiplexing

MAX9934

## Pin Configurations

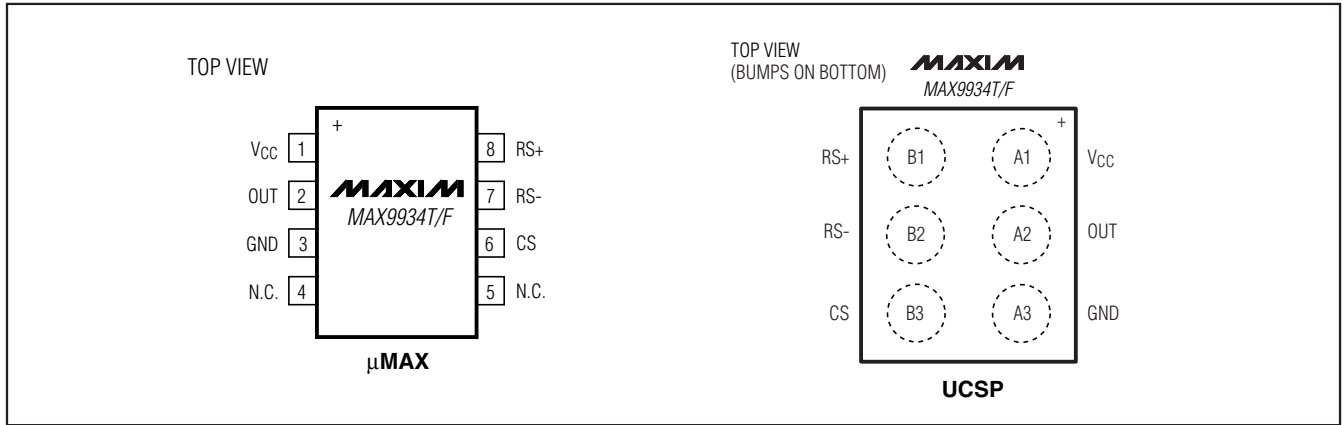

## Chip Information

PROCESS: BICMOS

# High-Precision, Low-Voltage, Current-Sense Amplifier with Current Output and Chip Select for Multiplexing

## Package Information

For the latest package outline information and land patterns, go to [www.maxim-ic.com/packages](http://www.maxim-ic.com/packages). Note that a "+", "#", or "-" in the package code indicates RoHS status only. Package drawings may show a different suffix character, but the drawing pertains to the package regardless of RoHS status.

PACKAGE TYPE	PACKAGE CODE	DOCUMENT NO.
2x3 UCSP	R61A1+1	<a href="#">21-0228</a>
8 $\mu$ MAX	U8+1	<a href="#">21-0036</a>

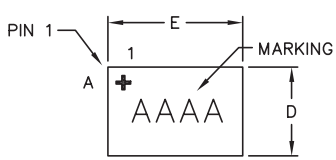

TOP VIEW

COMMON DIMENSIONS	
A	0.64±0.05
A1	0.24±0.03
b	∅0.30 REF
D1	0.50 BASIC
E1	1.00 BASIC
e	0.50 BASIC
SD	0.25 BASIC
SE	0.00 BASIC

PKG. CODE	VARIABLE DIMENSIONS		DEPOPULATED BUMPS
	E	D	
R61A1+1	1.52±0.05	1.00±0.05	NONE
R61B1+1	1.57±0.05	1.05±0.05	NONE
R61C1+1	1.57±0.05	1.16±0.05	NONE

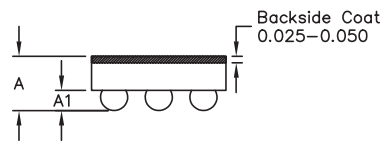

SIDE VIEW

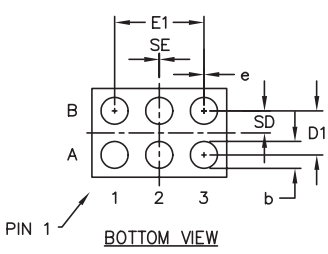

BOTTOM VIEW

**NOTES:**

- Terminal pitch is defined by terminal center to center value.
- Outer dimension (D & E) is defined by center lines between scribe lines.
- All dimensions in millimeters.
- Marking shown is for package orientation reference only.
- Tolerance is ± 0.02mm unless specified otherwise.
- All dimensions apply to PbFree (+) package codes only.



TITLE:  
PACKAGE OUTLINE  
6 BUMPS, 2x3 ARRAY, UCSP (R) PKG.

APPROVAL	DOCUMENT CONTROL NO. 21-0228	REV. A	1/1
----------	---------------------------------	-----------	-----

-DRAWING NOT TO SCALE-

# High-Precision, Low-Voltage, Current-Sense Amplifier with Current Output and Chip Select for Multiplexing

MAX9934

## Package Information (continued)

For the latest package outline information and land patterns, go to [www.maxim-ic.com/packages](http://www.maxim-ic.com/packages). Note that a "+", "#", or "-" in the package code indicates RoHS status only. Package drawings may show a different suffix character, but the drawing pertains to the package regardless of RoHS status.

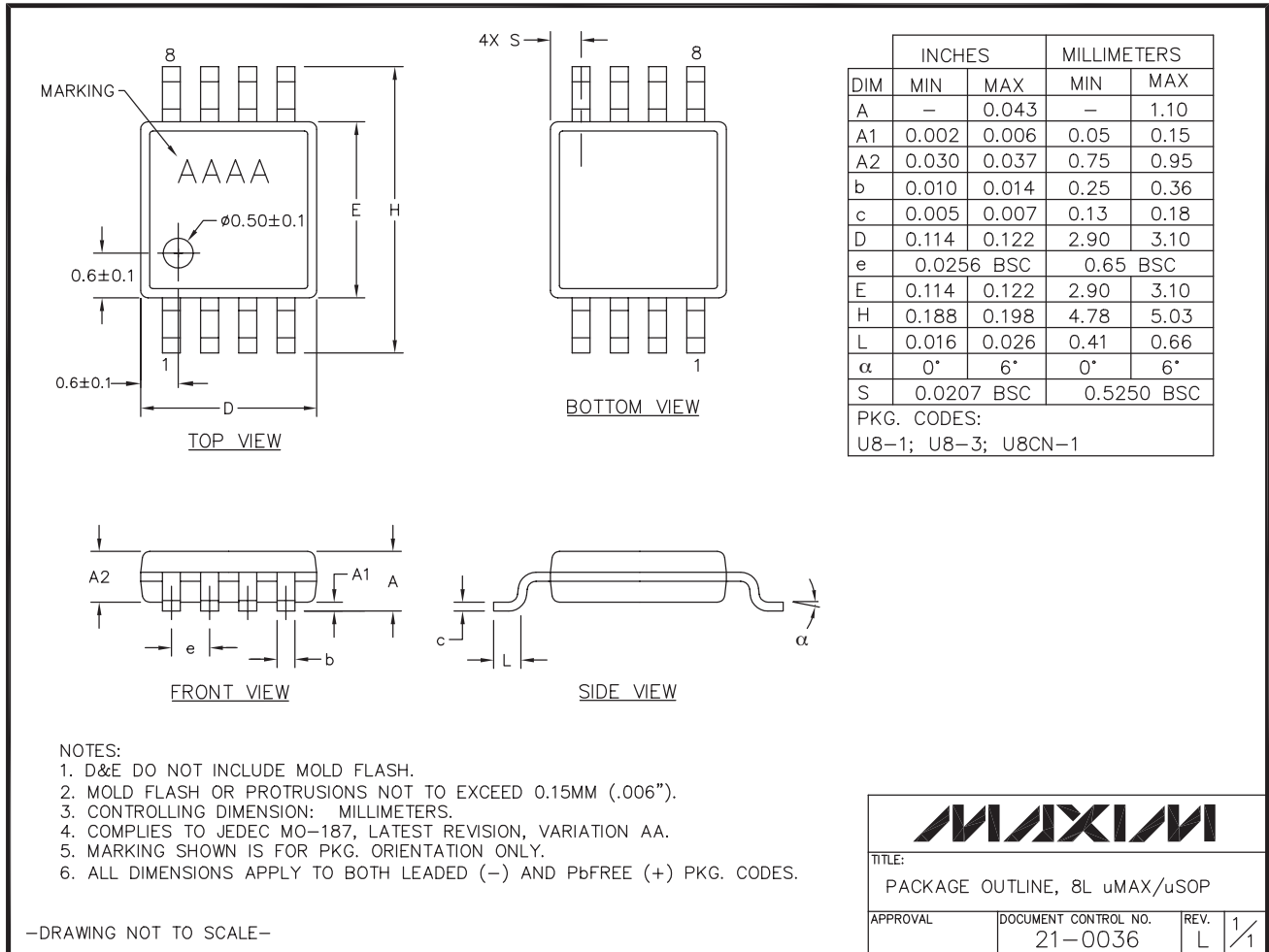

# High-Precision, Low-Voltage, Current-Sense Amplifier with Current Output and Chip Select for Multiplexing

## Revision History

REVISION NUMBER	REVISION DATE	DESCRIPTION	PAGES CHANGED
0	10/09	Initial release	—
1	1/10	Removed $\mu$ DFN package option	1–10, 18
2	4/10	Removed future product references and updated lead temperature	1, 2

MAX9934

Maxim cannot assume responsibility for use of any circuitry other than circuitry entirely embodied in a Maxim product. No circuit patent licenses are implied. Maxim reserves the right to change the circuitry and specifications without notice at any time.

Maxim Integrated Products, 120 San Gabriel Drive, Sunnyvale, CA 94086 408-737-7600 \_\_\_\_\_ 21