

Single, Dual, Triple, and Quad Standard-Definition Video Filter Amplifiers with AC-Coupled Input Buffers

General Description

The MAX9586–MAX9589 are small, low-power, multi-channel video amplifiers with integrated reconstruction filters and input clamps. Specially suited for standard-definition video signals, these devices are ideal for a wide range of television and set-top box applications.

The video signals from the outputs of a digital-to-analog converter (DAC) are AC-coupled to the inputs of the MAX9586–MAX9589. External video signals, in which the DC bias is usually not known, can also be AC-coupled to the inputs of the MAX9586–MAX9589. The input sync-tip clamps set the DC level of composite video or luma signals, and the input bias circuits set the DC level of chroma signals.

The reconstruction filter typically has $\pm 1\text{dB}$ passband flatness at 8.5MHz and 55dB attenuation at 27MHz. The amplifiers have 2V/V gain and the outputs can be DC-coupled to a 75 Ω load, which is the equivalent of two video loads, or AC-coupled to a 150 Ω load.

The MAX9586–MAX9589 operate from a 2.7V to 3.6V single supply and are specified over the -40°C to $+125^{\circ}\text{C}$ automotive temperature range. The MAX9586–MAX9589 are offered in small SOT23 and μMAX packages.

Applications

Set-Top Boxes

Televisions

μMAX is a registered trademark of Maxim Integrated Products, Inc.

Features

- ◆ Single- (MAX9586), Dual- (MAX9587), Triple- (MAX9588), and Quad- (MAX9589) Channel Devices
- ◆ 8.5MHz, $\pm 1\text{dB}$ Passband
- ◆ 55dB Attenuation at 27MHz
- ◆ Fixed Gain of 2V/V
- ◆ Low Power: 4.25mA per Channel
- ◆ 2.7V to 3.6V Single-Supply Operation
- ◆ Small SOT23 and μMAX Packages

Ordering Information

PART	PIN-PACKAGE	CHANNELS	PKG CODE
MAX9586AZK+T	5 Thin SOT23-5	1	Z5-1
MAX9587AZT+T	6 Thin SOT23-6	2	Z6-1
MAX9588AUA+T	8 μMAX -8	3	U8-1
MAX9589AUB+T	10 μMAX -10	4	U10-2

Note: All devices are specified over the -40°C to $+125^{\circ}\text{C}$ operating temperature range.

+Denotes a lead-free package.

T = Tape and reel.

Pin Configurations and Selector Guide located at end of data sheet.

Block Diagrams

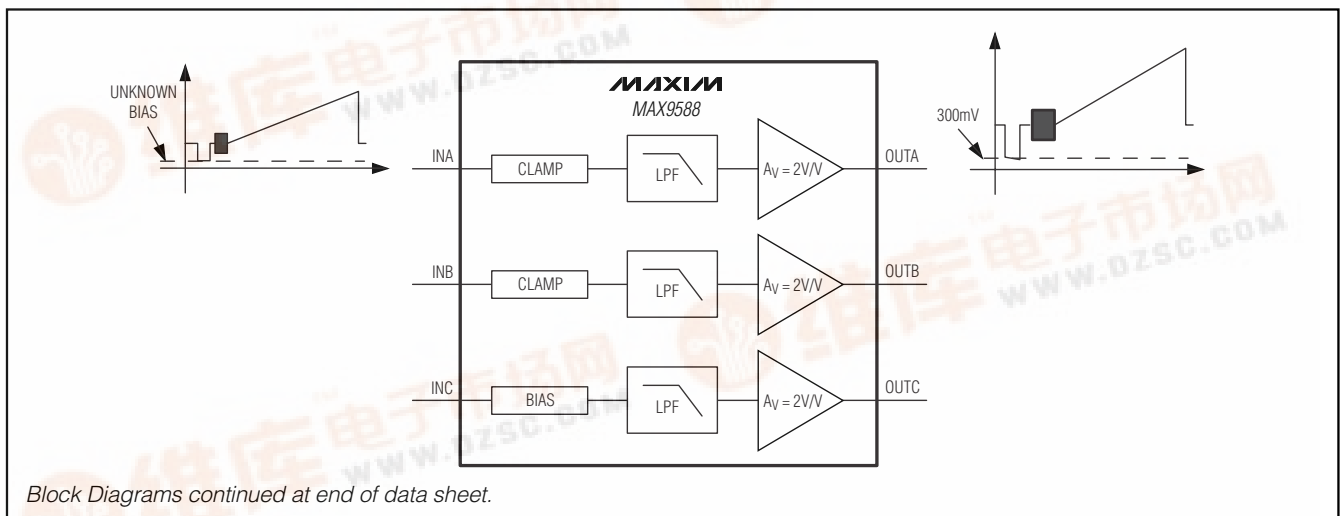

[查询"MAX9586"供应商](#)

Single, Dual, Triple, and Quad Standard-Definition Video Filter Amplifiers with AC-Coupled Input Buffers

ABSOLUTE MAXIMUM RATINGS

V _{DD} to GND	-0.3V to +4V	6-Pin Thin SOT23 (derate 9.1mW/°C above +70°C).....	727mW
IN_ to GND	-0.3V to +4V	8-Pin μMAX (derate 4.5mW/°C above +70°C).....	362mW
SHDN to GND.....	-0.3V to +4V	10-Pin μMAX (derate 5.6mW/°C above +70°C).....	444mW
OUT_ Short Circuit Duration to V _{DD} , GND	Continuous	Operating Temperature Range	-40°C to +125°C
Continuous Input Current		Junction Temperature.....	+150°C
IN_, SHDN	±20mA	Storage Temperature Range	-65°C to +150°C
Continuous Power Dissipation (T _A = +70°C)		Lead Temperature (soldering, 10s).....	+300°C
5-Pin Thin SOT23 (derate 9.1mW/°C above +70°C).....			

Stresses beyond those listed under "Absolute Maximum Ratings" may cause permanent damage to the device. These are stress ratings only, and functional operation of the device at these or any other conditions beyond those indicated in the operational sections of the specifications is not implied. Exposure to absolute maximum rating conditions for extended periods may affect device reliability.

ELECTRICAL CHARACTERISTICS

(V_{DD} = 3.3V, GND = 0V, V_{RL} = no load, T_A = T_{MIN} to T_{MAX}, unless otherwise noted. Typical values are at T_A = +25°C.) (Note 1)

PARAMETER	SYMBOL	CONDITIONS		MIN	TYP	MAX	UNITS
Supply Voltage Range	V _{DD}	Guaranteed by PSRR		2.7		3.6	V
Supply Current	I _{DD}	Per channel			4.25	8	mA
Sync-Tip Clamp Level	V _{CCLP}	Sync-tip clamp		0.24		0.41	V
Input Voltage Range	V _{IN}	Guaranteed by DC voltage gain	V _{DD} = 2.7V, sync-tip clamp input			1.05	V _{P-P}
			V _{DD} = 2.7V, bias input			1.05	
			V _{DD} = 3V, sync-tip clamp input			1.2	
			V _{DD} = 3V, bias input			1.2	
Sync Crush		Sync-tip clamp, percentage reduction in sync pulse (0.3V _{P-P}), guaranteed by input clamping current measurement, measured at input				2	%
Input Clamping Current		Sync-tip clamp			1	2	μA
Maximum Input Source Resistance					300		Ω
Bias Voltage	V _{BIAS}	Bias circuit		0.40	0.50	0.62	V
Input Resistance		Bias circuit			11		kΩ
DC Voltage Gain (Note 2)	A _V	R _L = 150Ω to GND	V _{DD} = 2.7V, V _{IN} = V _{CCLP} to (V _{CCLP} + 1.05V)	1.95	2.00	2.04	V/V
			V _{DD} = 3V, V _{IN} = V _{CCLP} to (V _{CCLP} + 1.2V)	1.95	2.00	2.04	
			V _{DD} = 2.7V, V _{IN} = V _{BIAS} ±0.525V	1.95	2.00	2.04	
			V _{DD} = 3V, V _{IN} = V _{BIAS} ±0.600V	1.95	2.00	2.04	
DC Gain Matching		Guaranteed by DC voltage gain		-2	0	+2	%
Output Level		Measured at V _{OUT} , IN_ = 0.1μF to GND, R _L = 150Ω to GND	Sync-tip clamp	0.2	0.3	0.4	V
			Bias circuit		1.3		

Single, Dual, Triple, and Quad Standard-Definition Video Filter Amplifiers with AC-Coupled Input Buffers

ELECTRICAL CHARACTERISTICS (continued)

($V_{DD} = 3.3V$, $GND = 0V$, $V_{RL} = \text{no load}$, $T_A = T_{MIN}$ to T_{MAX} , unless otherwise noted. Typical values are at $T_A = +25^\circ C$.) (Note 1)

PARAMETER	SYMBOL	CONDITIONS	MIN	TYP	MAX	UNITS	
Output-Voltage Swing		Sync-tip clamp	Measured at output, $V_{DD} = 2.7V$, $V_{IN} = V_{CLP}$ to $(V_{CLP} + 1.05V)$, $R_L = 150\Omega$ to $-0.2V$		2.1		VP-P
			Measured at output, $V_{DD} = 2.7V$, $V_{IN} = V_{CLP}$ to $(V_{CLP} + 1.05V)$, $R_L = 150\Omega$ to $V_{DD}/2$		2.1		
			Measured at output, $V_{DD} = 3V$, $V_{IN} = V_{CLP}$ to $(V_{CLP} + 1.2V)$, $R_L = 150\Omega$ to $-0.2V$		2.4		
			Measured at output, $V_{DD} = 3V$, $V_{IN} = V_{CLP}$ to $(V_{CLP} + 1.2V)$, $R_L = 150\Omega$ to $V_{DD}/2$		2.4		
			Measured at output, $V_{DD} = 3.135V$, $V_{IN} = V_{CLP}$ to $(V_{CLP} + 1.05V)$, $R_L = 75\Omega$ to $-0.2V$		2.1		
		Bias Circuit	Measured at output, $V_{DD} = 2.7V$, $V_{IN} = V_{BIAS} \pm 0.525V$, $R_L = 150\Omega$ to $-0.2V$		2.1		
			Measured at output, $V_{DD} = 2.7V$, $V_{IN} = V_{BIAS} \pm 0.500V$, $R_L = 150\Omega$ to $V_{DD}/2$		2.0		
			Measured at output, $V_{DD} = 3V$, $V_{IN} = V_{BIAS} \pm 0.600V$, $R_L = 150\Omega$ to $-0.2V$		2.4		
			Measured at output, $V_{DD} = 3V$, $V_{IN} = V_{BIAS} \pm 0.500V$, $R_L = 150\Omega$ to $V_{DD}/2$		2.0		
			Measured at output, $V_{DD} = 3.135V$, $V_{IN} = V_{BIAS} \pm 0.525V$, $R_L = 75\Omega$ to $-0.2V$		2.1		
Output Short-Circuit Current		Short to GND (sourcing)		140		mA	
		Short to V_{DD} (sinking)		70			
Output Resistance	R_{OUT}	$V_{OUT} = 1.5V$, $-10mA \leq I_{LOAD} \leq +10mA$		0.2		Ω	

MAX9586-MAX9589

Single, Dual, Triple, and Quad Standard-Definition Video Filter Amplifiers with AC-Coupled Input Buffers

ELECTRICAL CHARACTERISTICS (continued)

($V_{DD} = 3.3V$, $GND = 0V$, $VR_L = \text{no load}$, $T_A = T_{MIN}$ to T_{MAX} , unless otherwise noted. Typical values are at $T_A = +25^\circ C$.) (Note 1)

PARAMETER	SYMBOL	CONDITIONS	MIN	TYP	MAX	UNITS		
Power-Supply Rejection Ratio		$2.7V \leq V_{DD} \leq 3.6V$	48			dB		
		$f = 1MHz$, $100mV_{P-P}$	29					
Standard-Definition Reconstruction Filter		$\pm 1dB$ passband flatness	8.5			MHz		
		$V_{OUT_} = 2V_{P-P}$, reference frequency is 100kHz	$f = 5.5MHz$	-0.15			dB	
			$f = 9.5MHz$	-3				
$f = 27MHz$	-55							
Differential Gain	DG	5-step modulated staircase of 129mV step size and 286mV peak-to-peak subcarrier amplitude, $f = 4.43MHz$	0.1			%		
Differential Phase	DP	5-step modulated staircase of 129mV step size and 286mV peak-to-peak subcarrier amplitude, $f = 4.43MHz$	0.4			Degrees		
2T Pulse-to-Bar K Rating		$2T = 200ns$, bar time is 18 μs ; the beginning 2.5% and the ending 2.5% of the bar time are ignored	0.6			K%		
2T Pulse Response		$2T = 200ns$	0.2			K%		
2T Bar Response		$2T = 200ns$, bar time is 18 μs ; the beginning 2.5% and the ending 2.5% of the bar time are ignored	0.2			K%		
Nonlinearity		5-step staircase	0			%		
Group Delay Distortion		$100kHz \leq f \leq 5.5MHz$, outputs are $2V_{P-P}$	9			ns		
Peak Signal to RMS Noise		$100kHz \leq f \leq 5.5MHz$	71			dB		
Output Impedance		$f = 5.5MHz$	4.8			Ω		
All-Hostile Crosstalk		$f = 4.43MHz$	-64			dB		

Note 1: All devices are 100% production tested at $T_A = +25^\circ C$. Specifications over temperature limits are guaranteed by design.

Note 2: Voltage gain (A_V) is a two-point measurement in which the output-voltage swing is divided by the input-voltage swing.

Single, Dual, Triple, and Quad Standard-Definition Video Filter Amplifiers with AC-Coupled Input Buffers

Typical Operating Characteristics

($V_{DD} = \overline{SHDN} = +3.3V$, video outputs have $R_L = 150\Omega$ connected to GND, $T_A = +25^\circ C$, unless otherwise noted.)

MAX9586-MAX9589

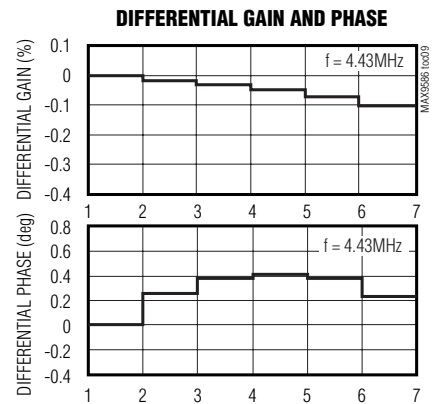
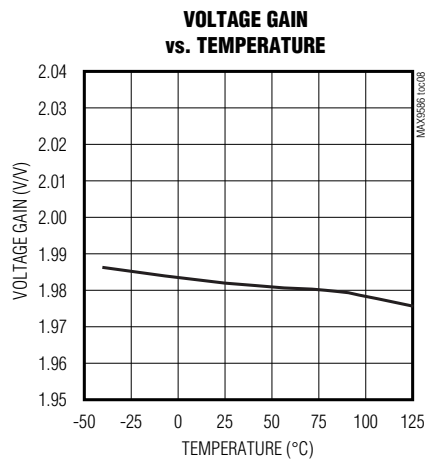
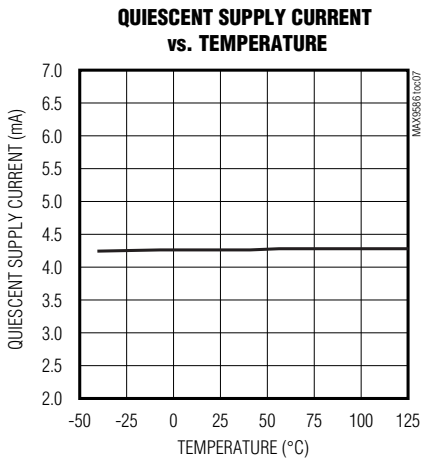
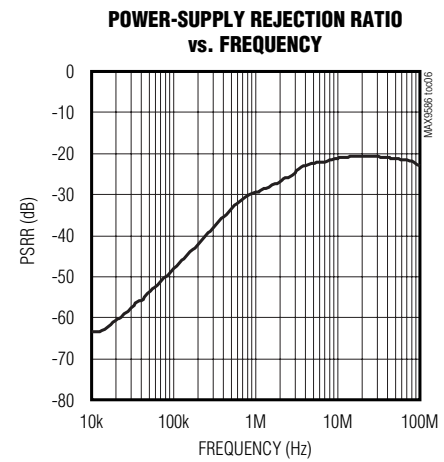
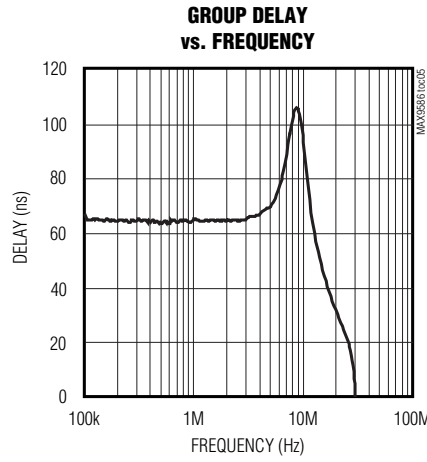
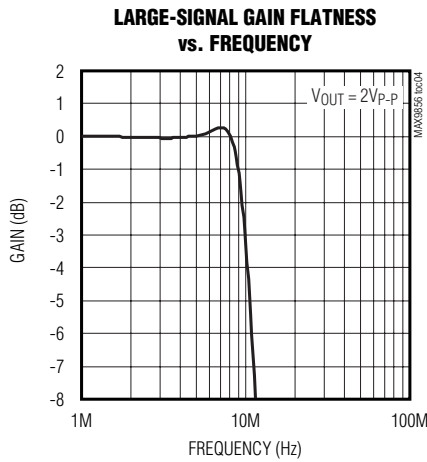
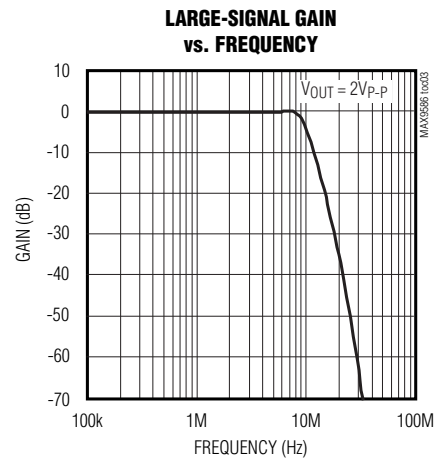
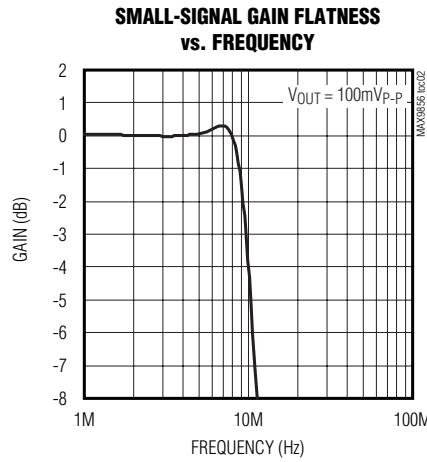
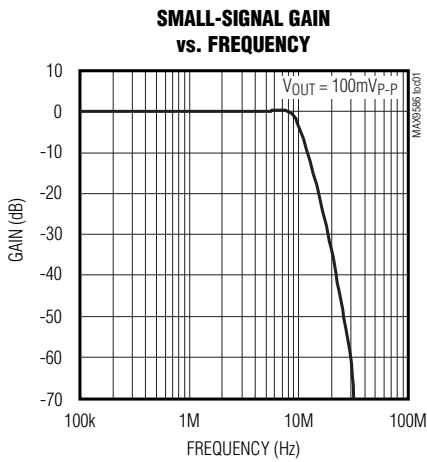

[查询"MAX9586"供应商](#)

Single, Dual, Triple, and Quad Standard-Definition Video Filter Amplifiers with AC-Coupled Input Buffers

Typical Operating Characteristics (continued)

($V_{DD} = \overline{SHDN} = +3.3V$, video outputs have $R_L = 150\Omega$ connected to GND, $T_A = +25^\circ C$, unless otherwise noted.)

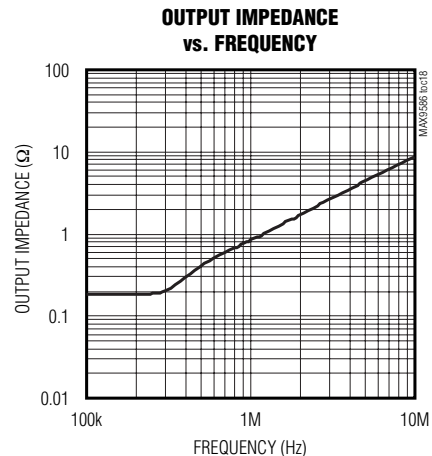
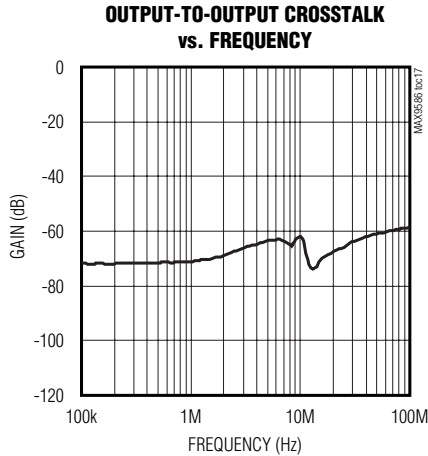
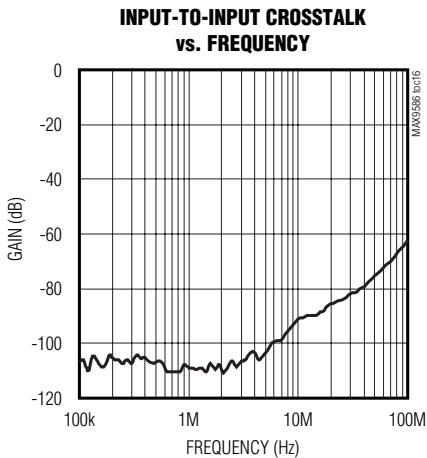
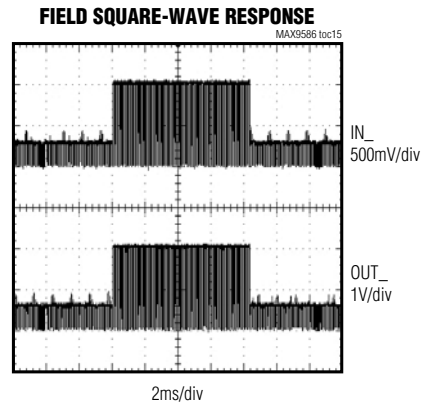
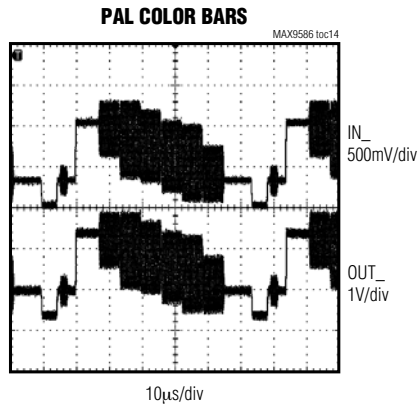
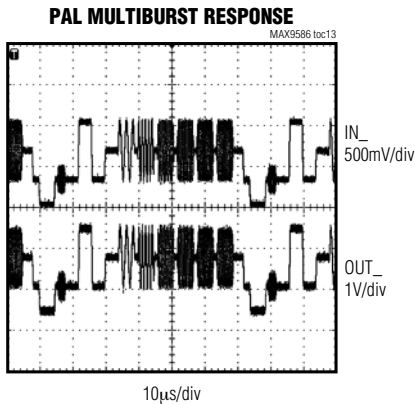
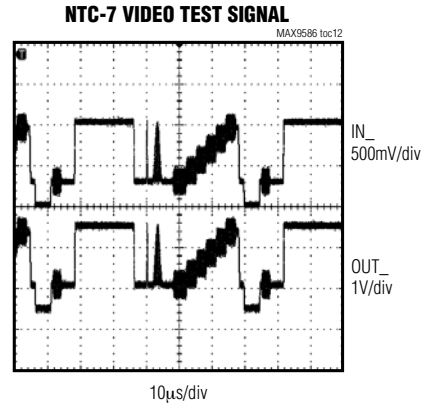
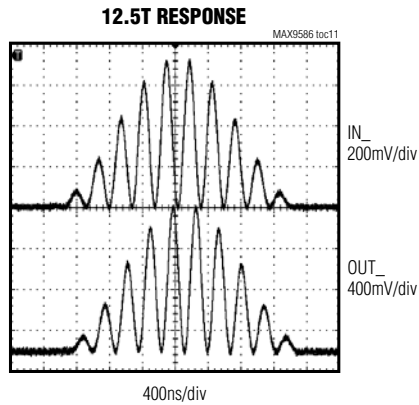
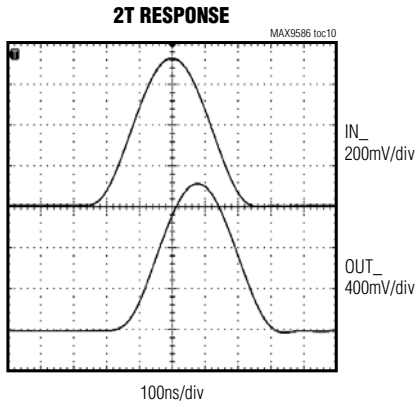

Single, Dual, Triple, and Quad Standard-Definition Video Filter Amplifiers with AC-Coupled Input Buffers

Pin Description

PIN				NAME	FUNCTION
MAX9586	MAX9587	MAX9588	MAX9589		
5 SOT23	6 SOT23	8 μ MAX	10 μ MAX		
1	—	—	—	$\overline{\text{SHDN}}$	Active-Low Shutdown Input. Connect to GND to shut down.
2	2	4	5	GND	Ground
3	—	—	—	IN	Video Input
—	3	1	1	INA	Video Input A
—	1	2	2	INB	Video Input B
—	—	3	3	INC	Video Input C
—	—	—	4	IND	Video Input D
4	—	—	—	OUT	Video Output
—	4	7	9	OUTA	Video Output A
—	6	6	8	OUTB	Video Output B
—	—	5	7	OUTC	Video Output C
—	—	—	6	OUTD	Video Output D
5	5	8	10	V _{DD}	Positive Power Supply. Bypass to GND with a 0.1 μ F capacitor.

MAX9586-MAX9589

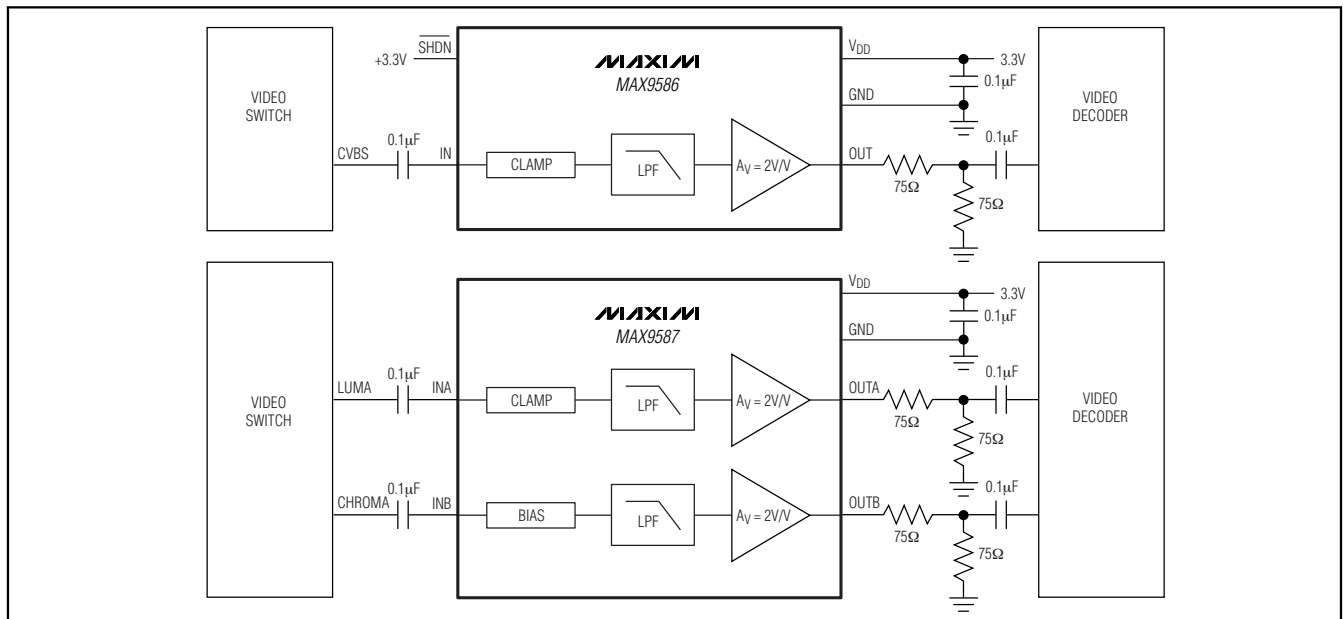

Figure 1. Typical Application Circuits for the MAX9586/MAX9587 (Anti-Alias Filter)

Single, Dual, Triple, and Quad Standard-Definition Video Filter Amplifiers with AC-Coupled Input Buffers

MAX9586-MAX9589

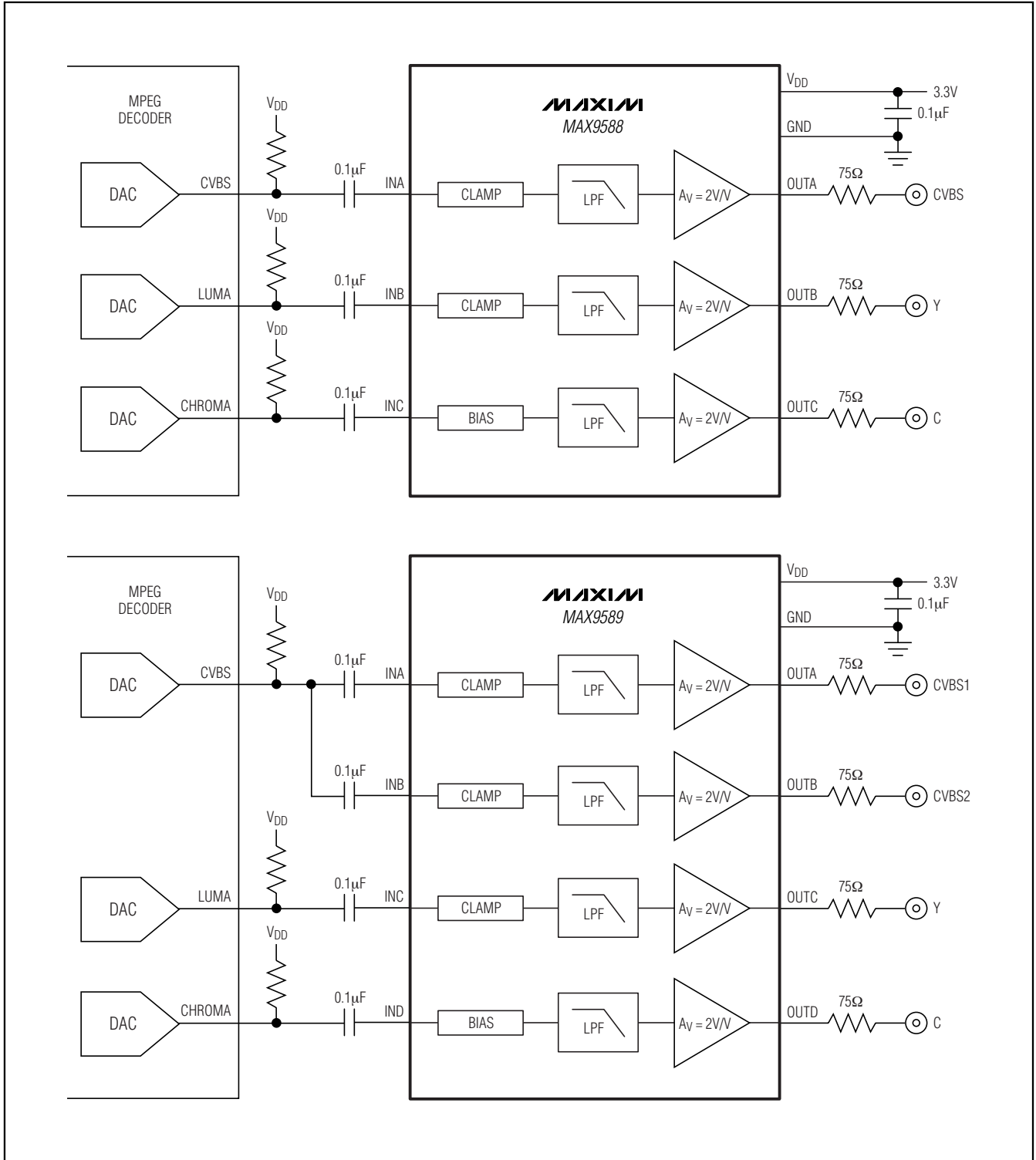

Figure 2. Typical Application Circuits for the MAX9588/MAX9589 (Reconstruction Filter)

Single, Dual, Triple, and Quad Standard-Definition Video Filter Amplifiers with AC-Coupled Input Buffers

Detailed Description

The MAX9586–MAX9589 filter and amplify the video DAC output in applications such as set-top boxes and televisions. These devices consist of input clamps, input bias circuits, lowpass filters, and gain of 2V/V output amplifiers capable of driving a standard 150 Ω video load to ground.

Inputs

The input stages of the MAX9586–MAX9589 are either sync-tip clamps or bias circuits. Sync-tip clamps accept AC-coupled CVBS or luma video signals with sync pulses. The sync-tip voltage is internally set to 300mV. Bias circuit inputs accept AC-coupled chroma, a subcarrier modulated with the color information. The bias voltage of the bias circuits is approximately 500mV.

Video Filter

The filter passband (± 1 dB) is typically 8.5MHz, which makes the device suitable for standard-definition video signals from all sources (e.g., broadcast and DVD). Broadcast video signals are channel limited: NTSC signals have 4.2MHz bandwidth and PAL signals have 5MHz bandwidth. Video signals from a DVD player, however, are not channel limited, so the bandwidth of DVD video signals can approach the Nyquist limit of 6.75MHz. (Recommendation ITU-R BT.601-5 specifies 13.5MHz as the sampling rate for standard-definition video). Therefore, the maximum bandwidth of the signal is 6.75MHz. To ease the filtering requirements, most modern video systems oversample by two times, clocking the video current DAC at 27MHz.

Outputs

The video output amplifiers can both source and sink load current, allowing output loads to be DC- or AC-coupled. The amplifier output stage needs approximately 300mV of headroom from either supply rail. The devices have an internal level-shift circuit that positions the sync tip at approximately 300mV at the output.

If the supply voltage is greater than 3.135V (5% below a 3.3V supply), each amplifier can drive two DC-coupled video loads to ground. If the supply is less than 3.135V, each amplifier can drive only one DC-coupled or AC-coupled video load.

Shutdown (MAX9586)

The MAX9586 draws less than 1 μ A supply current when SHDN is low. In shutdown mode, the amplifier output becomes high impedance.

Applications Information

AC-Coupling the Outputs

The outputs can be AC-coupled since the output stage can source and sink current as shown in Figure 3. Coupling capacitors should be 220 μ F or greater to keep the highpass filter, formed by the 150 Ω equivalent resistance of the video transmission line, to a corner frequency of 4.8Hz or below. The frame rate of PAL systems is 25Hz, and the frame rate of NTSC systems is 30Hz. The corner frequency should be well below the frame rate.

Power-Supply Bypassing and Ground

The MAX9586–MAX9589 operate from a single-supply voltage down to 2.7V, allowing for low-power operation. Bypass V_{DD} to GND with a 0.1 μ F capacitor. Place all external components as close as possible to the device.

Single, Dual, Triple, and Quad Standard-Definition Video Filter Amplifiers with AC-Coupled Input Buffers

MAX9586-MAX9589

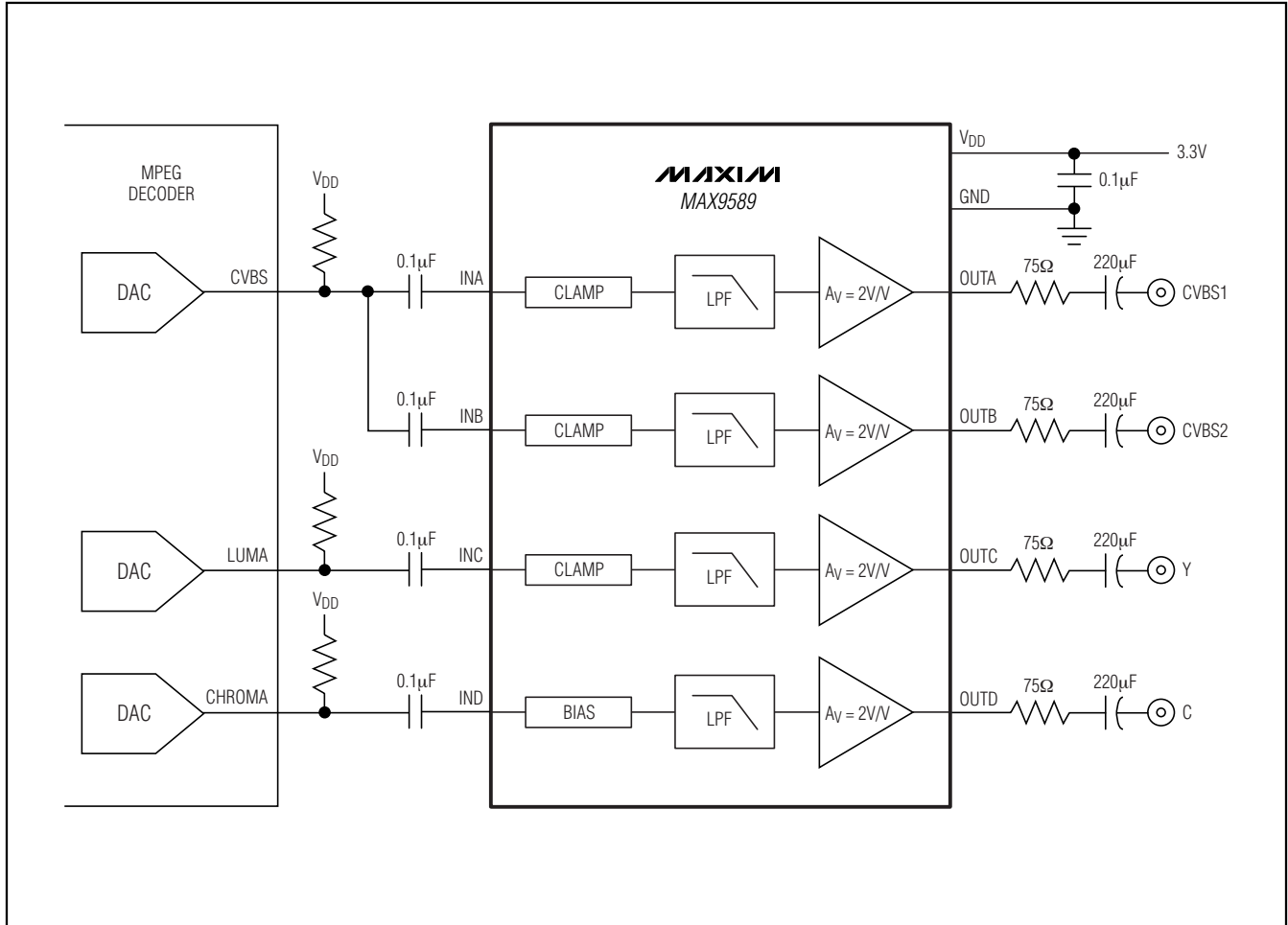
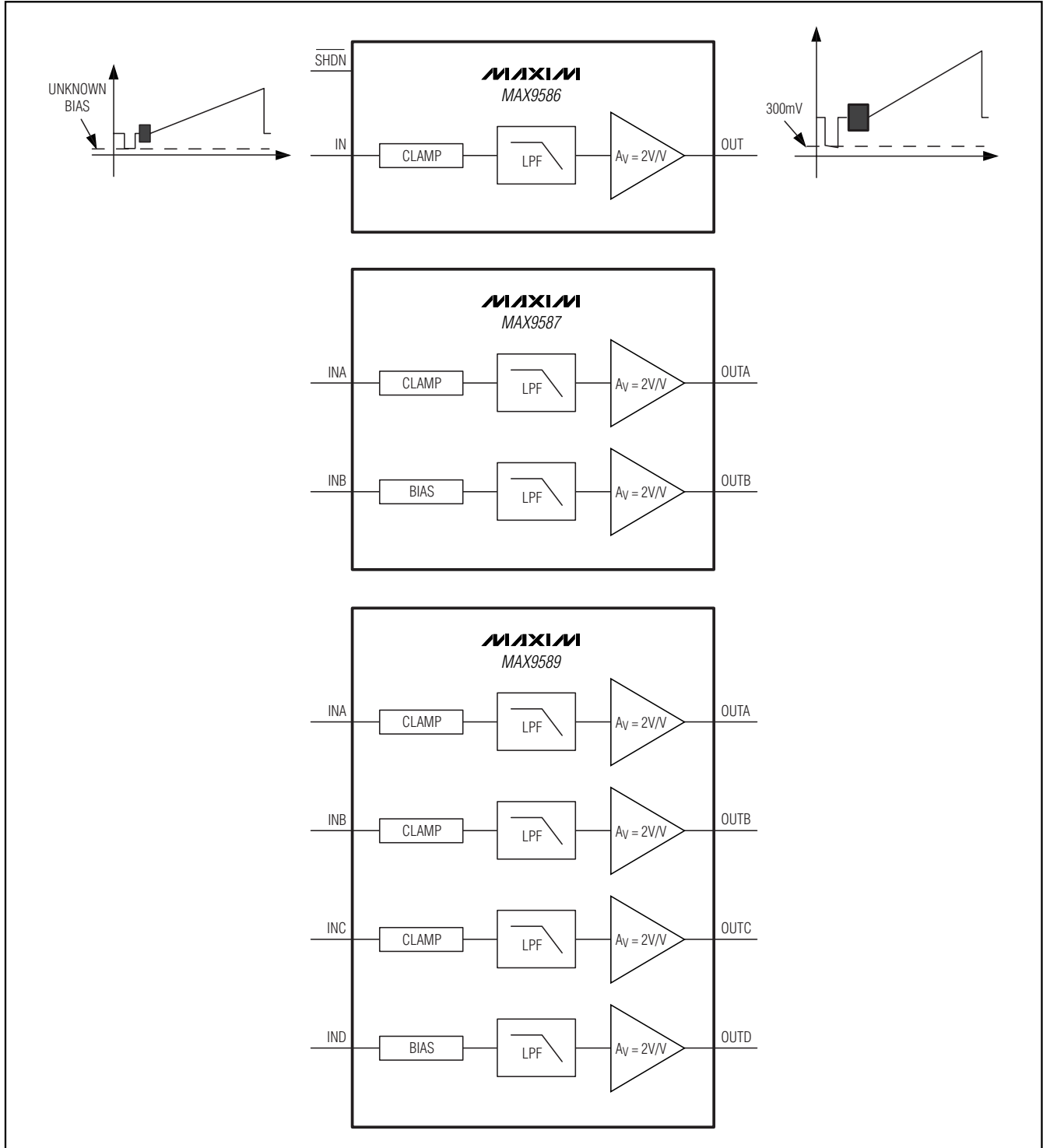

Figure 3. AC-Coupled Outputs

Single, Dual, Triple, and Quad Standard-Definition Video Filter Amplifiers with AC-Coupled Input Buffers

Block Diagrams (continued)



MAX9586-MAX9589

[查询"MAX9586"供应商](#)

Single, Dual, Triple, and Quad Standard-Definition Video Filter Amplifiers with AC-Coupled Input Buffers

Pin Configurations

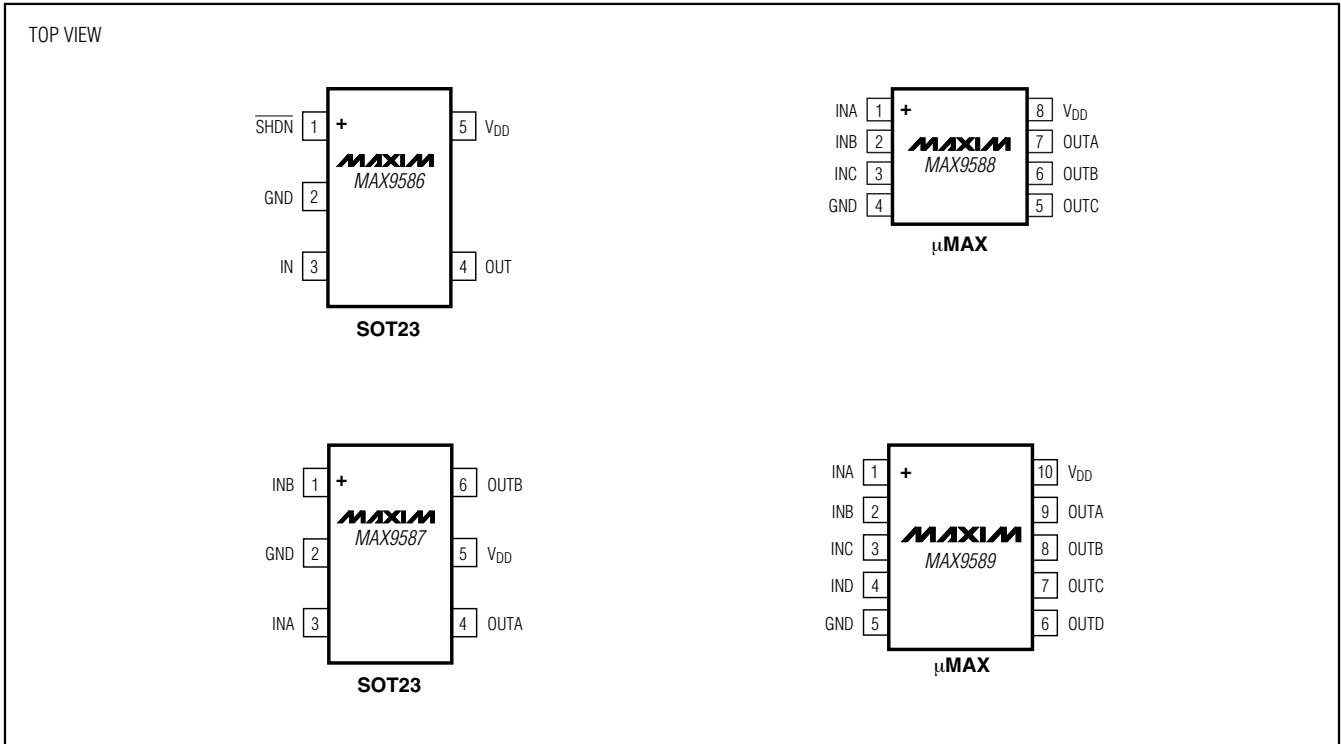

Selector Guide

PART	PIN-PACKAGE	PACKAGE SIZE	CHANNELS	TOP MARK
MAX9586AZK+T	5 SOT23-5	2.9mm x 1.6mm	1	ADSH
MAX9587AZT+T	6 SOT23-6	2.9mm x 1.6mm	2	AADI
MAX9588AUA+T	8 µMAX-8	3mm x 3mm	3	—
MAX9589AUB+T	10 µMAX-10	3mm x 3mm	4	—

Note: All devices are specified over the -40°C to +125°C operating temperature range.
+Denotes a lead-free package.

Chip Information

PROCESS: BICMOS

Single, Dual, Triple, and Quad Standard-Definition Video Filter Amplifiers with AC-Coupled Input Buffers

Package Information

(The package drawing(s) in this data sheet may not reflect the most current specifications. For the latest package outline information, go to www.maxim-ic.com/packages.)

MAX9586-MAX9589

THIN SOT23.EPS

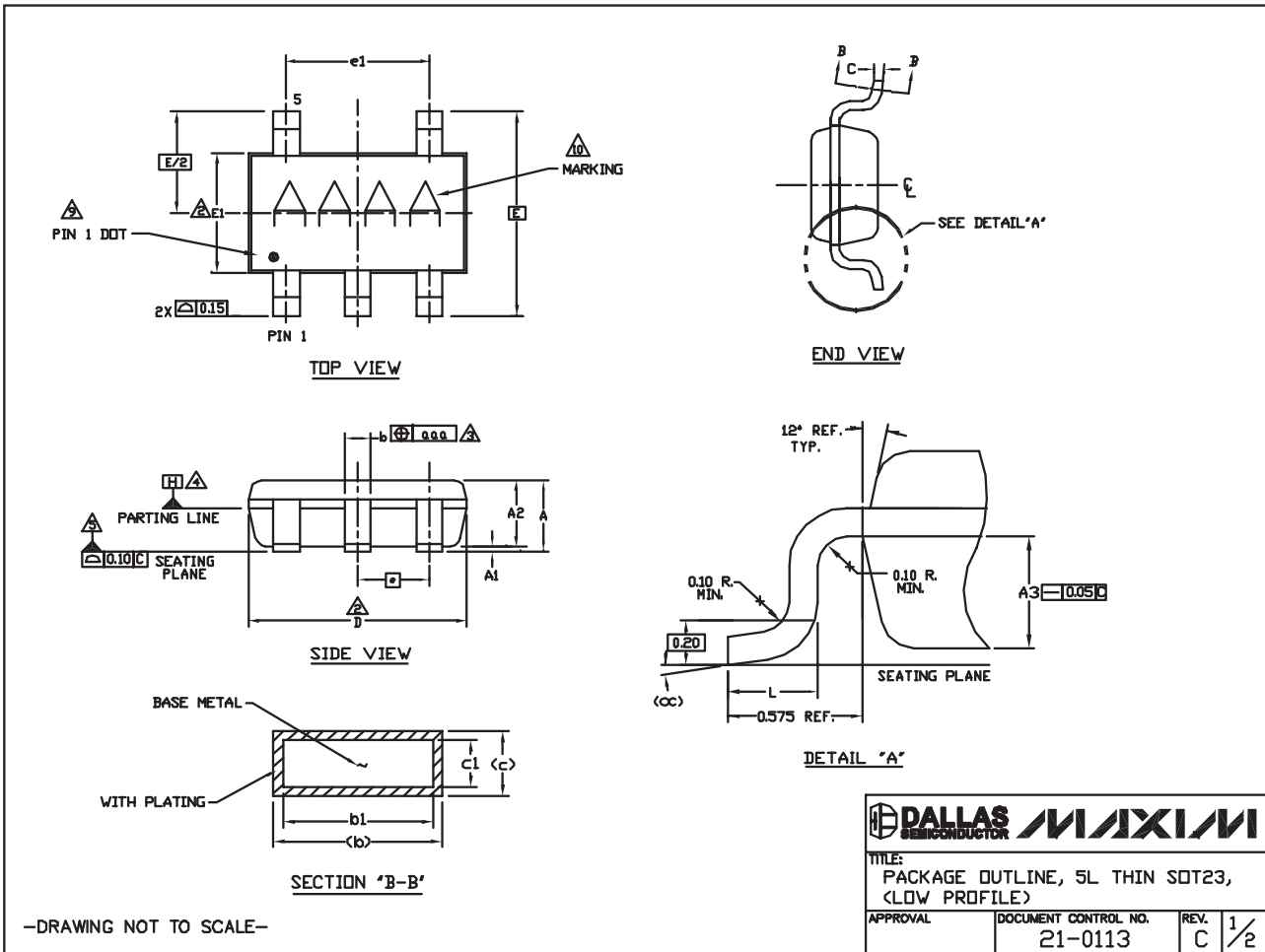

Single, Dual, Triple, and Quad Standard-Definition Video Filter Amplifiers with AC-Coupled Input Buffers

Package Information (continued)

(The package drawing(s) in this data sheet may not reflect the most current specifications. For the latest package outline information, go to www.maxim-ic.com/packages.)

NOTES:

1. ALL DIMENSIONS ARE IN MILLIMETERS.
2. 'D' AND 'E1' ARE REFERENCE DATUM AND DO NOT INCLUDE MOLD FLASH OR PROTRUSIONS, AND ARE MEASURED AT THE BOTTOM PARTING LINE. MOLD FLASH OR PROTRUSION SHALL NOT EXCEED 0.15mm ON 'D' AND 0.25mm ON 'E' PER SIDE.
3. THE LEAD WIDTH DIMENSION DOES NOT INCLUDE DAMBAR PROTRUSION. ALLOWABLE DAMBAR PROTRUSION SHALL BE 0.07mm TOTAL IN EXCESS OF THE LEAD WIDTH DIMENSION AT MAXIMUM MATERIAL CONDITION.
4. DATUM PLANE 'H' LOCATED AT MOLD PARTING LINE AND COINCIDENT WITH LEAD, WHERE LEAD EXITS PLASTIC BODY AT THE BOTTOM OF PARTING LINE.
5. THE LEAD TIPS MUST LIE WITHIN A SPECIFIED TOLERANCE ZONE. THIS TOLERANCE ZONE IS DEFINED BY TWO PARALLEL LINES. ONE PLANE IS THE SEATING PLANE, DATUM [C-J] AND THE OTHER PLANE IS AT THE SPECIFIED DISTANCE FROM [C-J] IN THE DIRECTION INDICATED. FORMED LEADS SHALL BE PLANAR WITH RESPECT TO ONE ANOTHER WITH 0.10mm AT SEATING PLANE.
6. THIS PART IS COMPLIANT WITH JEDEC SPECIFICATION MO-193 EXCEPT FOR THE 'e' DIMENSION WHICH IS 0.95mm INSTEAD OF 1.00mm. THIS PART IS IN FULL COMPLIANCE TO EIAJ SPECIFICATION SC-74.
7. COPLANARITY APPLIES TO THE EXPOSED PAD AS WELL AS THE TERMINALS. COPLANARITY SHALL NOT EXCEED 0.08mm.
8. WARPAGE SHALL NOT EXCEED 0.10mm.
9. THE TERMINAL #1 IDENTIFIER AND TERMINAL NUMBERING CONVENTION SHALL CONFORM TO JE5D 95-1 PP-012. DETAILS OF TERMINAL #1 IDENTIFIER ARE OPTIONAL. THE TERMINAL #1 IDENTIFIER MAY BE EITHER A MOLD OR MARKED FEATURE.
10. MARKING IS FOR PACKAGE ORIENTATION REFERENCE ONLY.
11. ALL DIMENSIONS APPLY TO BOTH LEADED (<->) AND LEAD FREE (<+>) PACKAGE CODES.

SYMBOLS			
	MIN	NDM	MAX
A	-	-	1.10
A1	0.00	0.075	0.10
A2	0.85	0.88	0.90
A3	0.50 BSC		
b	0.30	-	0.45
b1	0.25	0.35	0.40
c	0.15	-	0.20
c1	0.12	0.127	0.15
D	2.80	2.90	3.00
E	2.75 BSC		
E1	1.55	1.60	1.65
L	0.30	0.40	0.50
e1	1.90 BSC		
e	0.95 BSC		
OC	0°	4°	8°
aaa	0.20		
Pkg. codes:	Z5-1j Z5-2		

			
TITLE: PACKAGE OUTLINE, 5L THIN SOT23, (LOW PROFILE)			
APPROVAL	DOCUMENT CONTROL NO.	REV.	2/2
	21-0113	C	

-DRAWING NOT TO SCALE-

Single, Dual, Triple, and Quad Standard-Definition Video Filter Amplifiers with AC-Coupled Input Buffers

Package Information (continued)

(The package drawing(s) in this data sheet may not reflect the most current specifications. For the latest package outline information, go to www.maxim-ic.com/packages.)

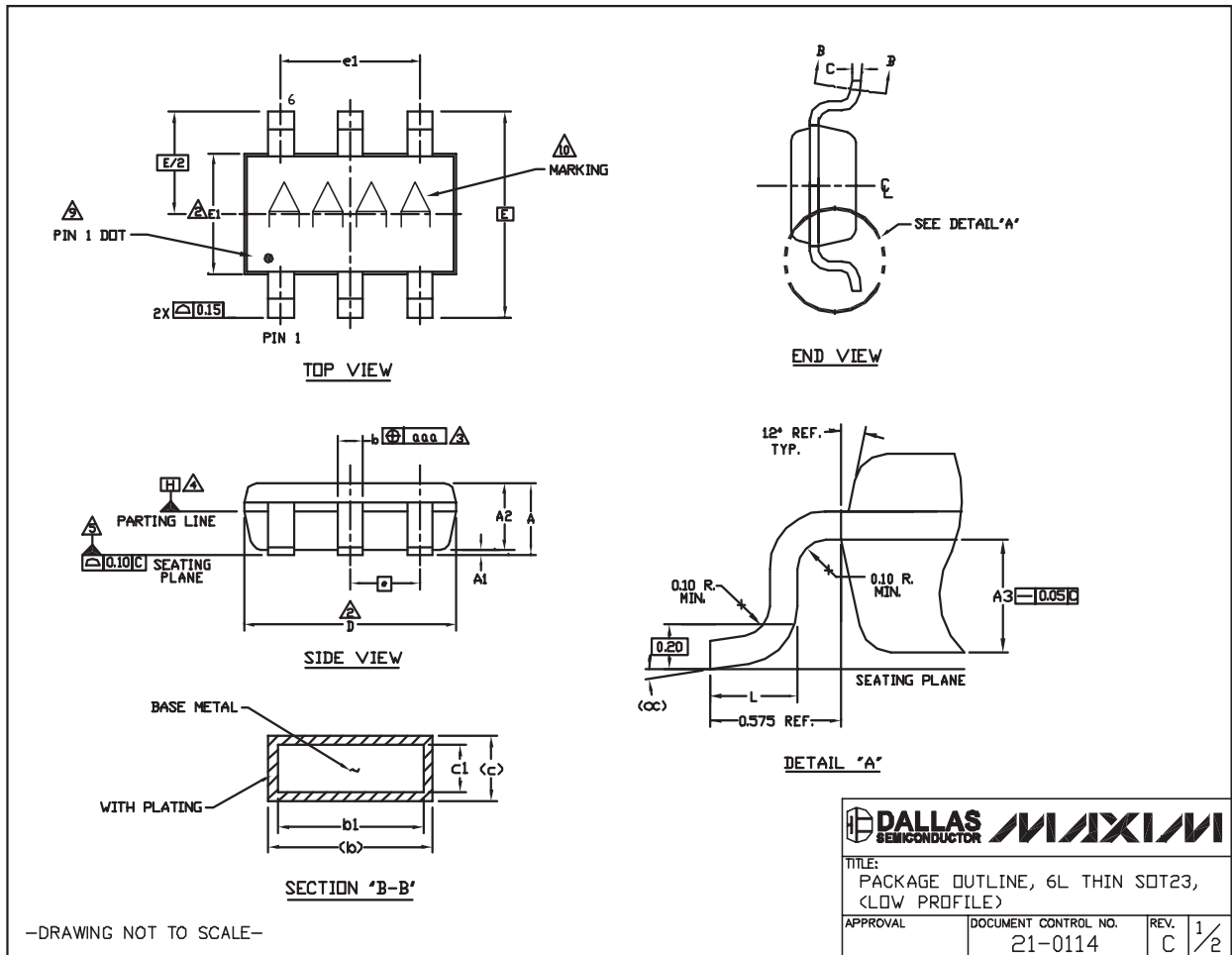

MAX9586-MAX9589

Single, Dual, Triple, and Quad Standard-Definition Video Filter Amplifiers with AC-Coupled Input Buffers

Package Information (continued)

(The package drawing(s) in this data sheet may not reflect the most current specifications. For the latest package outline information, go to www.maxim-ic.com/packages.)

NOTES

1. ALL DIMENSIONS ARE IN MILLIMETERS.
 2. 'D' AND 'E1' ARE REFERENCE DATUM AND DO NOT INCLUDE MOLD FLASH OR PROTRUSIONS, AND ARE MEASURED AT THE BOTTOM PARTING LINE. MOLD FLASH OR PROTRUSION SHALL NOT EXCEED 0.15mm ON 'D' AND 0.25mm ON 'E' PER SIDE.
 3. THE LEAD WIDTH DIMENSION DOES NOT INCLUDE DAMBAR PROTRUSION. ALLOWABLE DAMBAR PROTRUSION SHALL BE 0.07mm TOTAL IN EXCESS OF THE LEAD WIDTH DIMENSION AT MAXIMUM MATERIAL CONDITION.
 4. DATUM PLANE 'H' LOCATED AT MOLD PARTING LINE AND COINCIDENT WITH LEAD, WHERE LEAD EXITS PLASTIC BODY AT THE BOTTOM OF PARTING LINE.
 5. THE LEAD TIPS MUST LIE WITHIN A SPECIFIED TOLERANCE ZONE. THIS TOLERANCE ZONE IS DEFINED BY TWO PARALLEL LINES. ONE PLANE IS THE SEATING PLANE, DATUM [C-C] AND THE OTHER PLANE IS AT THE SPECIFIED DISTANCE FROM [C-C] IN THE DIRECTION INDICATED. FORMED LEADS SHALL BE PLANAR WITH RESPECT TO ONE ANOTHER WITH 0.10mm AT SEATING PLANE.
 6. THIS PART IS COMPLIANT WITH JEDEC SPECIFICATION MO-193 EXCEPT FOR THE 'e' DIMENSION WHICH IS 0.95mm INSTEAD OF 1.00mm. THIS PART IS IN FULL COMPLIANCE TO EIAJ SPECIFICATION SC-74.
 7. COPLANARITY APPLIES TO THE EXPOSED PAD AS WELL AS THE TERMINALS. COPLANARITY SHALL NOT EXCEED 0.08mm.
 8. WARPAGE SHALL NOT EXCEED 0.10mm.
 9. THE TERMINAL #1 IDENTIFIER AND TERMINAL NUMBERING CONVENTION SHALL CONFORM TO JEDEC 95-1 PP-012. DETAILS OF TERMINAL #1 IDENTIFIER ARE OPTIONAL. THE TERMINAL #1 IDENTIFIER MAY BE EITHER A MOLD OR MARKED FEATURE.
 10. MARKING IS FOR PACKAGE ORIENTATION REFERENCE ONLY.
11. ALL DIMENSIONS APPLY TO BOTH LEADED (-) AND LEAD FREE (+) PACKAGE CODES.

SYMBOLS

	MIN	NOM	MAX
A	-	-	1.10
A1	0.00	0.075	0.10
A2	0.65	0.68	0.90
A3	0.50 BSC		
b	0.30	-	0.45
b1	0.25	0.35	0.40
c	0.15	-	0.20
c1	0.12	0.127	0.15
D	2.80	2.90	3.00
E	2.75 BSC		
E1	1.55	1.60	1.65
L	0.30	0.40	0.50
e1	1.90 BSC		
e	0.95 BSC		
OC	0°	4°	8°
aaa	0.20		
Pkg. codes:	Z6-1, Z6-2		

-DRAWING NOT TO SCALE-



TITLE:
PACKAGE OUTLINE, 6L THIN SOT23,
(LOW PROFILE)

APPROVAL	DOCUMENT CONTROL NO. 21-0114	REV. C	2/2
----------	---------------------------------	-----------	-----

Single, Dual, Triple, and Quad Standard-Definition Video Filter Amplifiers with AC-Coupled Input Buffers

Package Information (continued)

(The package drawing(s) in this data sheet may not reflect the most current specifications. For the latest package outline information, go to www.maxim-ic.com/packages.)

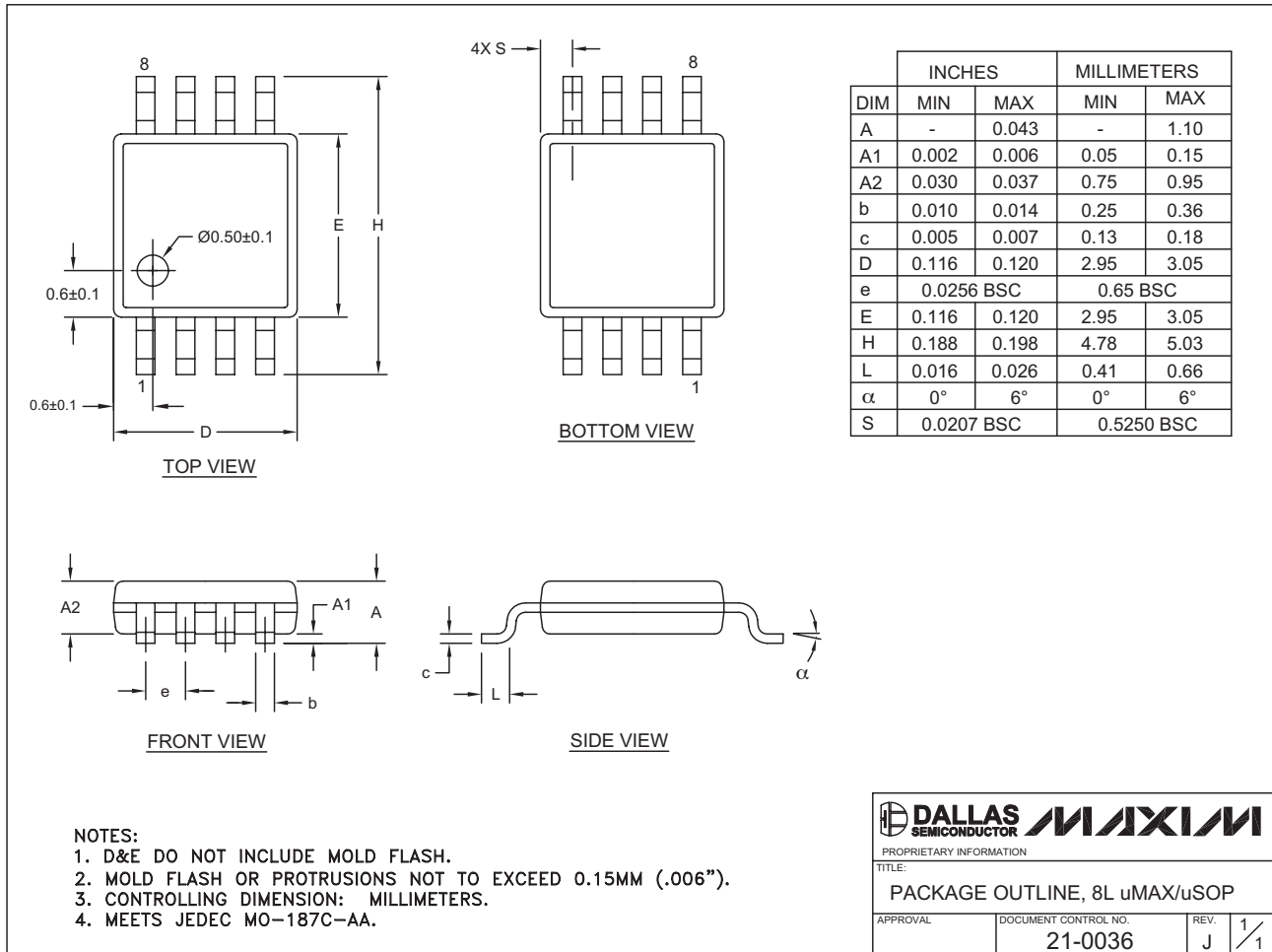

8LUMAXD EPS

MAX9586-MAX9589

[查询"MAX9586"供应商](#)

Single, Dual, Triple, and Quad Standard-Definition Video Filter Amplifiers with AC-Coupled Input Buffers

Package Information (continued)

(The package drawing(s) in this data sheet may not reflect the most current specifications. For the latest package outline information, go to www.maxim-ic.com/packages.)

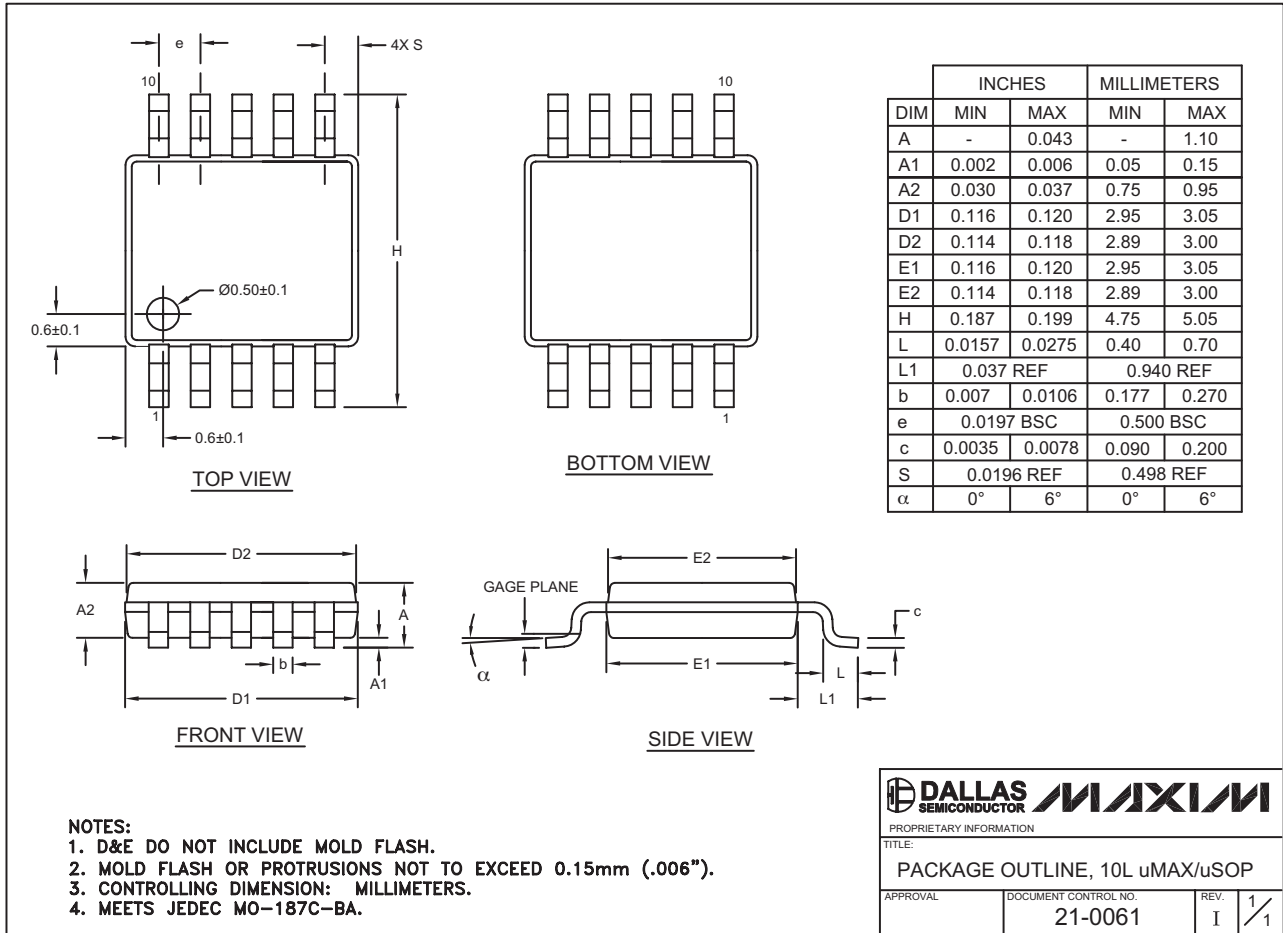

10L uMAX/uSOP

Revision History

- Pages changed at Rev 1: 1, 3, 24
- Pages changed at Rev 2: 1-4, 13, 25
- Pages changed at Rev 3: 1, 2, 7, 12-18 (deleted some package outlines)
- Pages changed at Rev 4: 1, 4, 5, 9, 18
- Pages changed at Rev 5: 1, 18

Maxim cannot assume responsibility for use of any circuitry other than circuitry entirely embodied in a Maxim product. No circuit patent licenses are implied. Maxim reserves the right to change the circuitry and specifications without notice at any time.

18 **Maxim Integrated Products, 120 San Gabriel Drive, Sunnyvale, CA 94086 408-737-7600**