

**NPN EPITAXIAL SILICON TRANSISTOR
 FOR MICROWAVE LOW-NOISE AMPLIFICATION**

The 2SC3587 is an NPN epitaxial transistor designed for low-noise amplification at 0.5 to 6.0 GHz. This transistor has low-noise and high-gain characteristics in a wide collector current region, and has a wide dynamic range.

FEATURES

- Low noise : NF = 1.7 dB TYP. @ f = 2 GHz
 NF = 2.6 dB TYP. @ f = 4 GHz
- High power gain : GA = 12.5 dB TYP. @ f = 2 GHz
 GA = 8.0 dB TYP. @ f = 4 GHz

ABSOLUTE MAXIMUM RATINGS (TA = 25 °C)

PARAMETER	SYMBOL	RATING	UNIT
Collector to Base Voltage	V _{CB0}	20	V
Collector to Emitter Voltage	V _{CEO}	10	V
Emitter to Base Voltage	V _{EBO}	1.5	V
Collector Current	I _c	35	mA
Total Power Dissipation	P _T (T _C = 25 °C)	580	mW
Junction Temperature	T _j	200	°C
Storage Temperature	T _{stg}	-65 to +150	°C

PACKAGE DIMENSIONS (in mm)

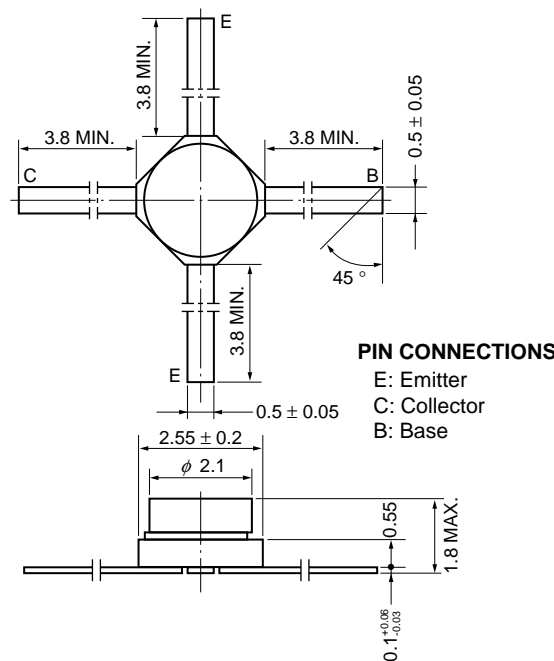

ELECTRICAL CHARACTERISTICS (TA = 25 °C)

PARAMETER	SYMBOL	TEST CONDITIONS	MIN.	TYP.	MAX.	UNIT
Collector Cut-off Current	I _{cBO}	V _{CB} = 10 V			1.0	μA
Emitter Cut-off Current	I _{EBO}	V _{EB} = 1 V			1.0	μA
DC Current Gain	h _{FE}	V _{CE} = 6 V, I _c = 10 mA Pulse	50	100	250	
Gain Bandwidth Product	f _T	V _{CE} = 6 V, I _c = 10 mA		10.0		GHz
Reverse Transfer Capacitance	C _{re}	V _{CB} = 10 V, f = 1 MHz		0.2	0.7	pF
Noise Figure	NF ^{Note}	V _{CE} = 6 V, I _c = 5 mA	f = 2 GHz	1.7	2.4	dB
			f = 4 GHz	2.6		dB
Insertion Gain	S _{21e} ²	V _{CE} = 6 V, I _c = 10 mA	f = 2 GHz	10.5	12.5	dB
			f = 4 GHz	7.5		dB
Maximum Available Gain	MAG	V _{CE} = 6 V, I _c = 10 mA, f = 4 GHz		10		dB
Power Gain	G _A	V _{CE} = 6 V, I _c = 5 mA	f = 2 GHz	12.5		dB
			f = 4 GHz	8.0		dB

查询"2SC3587"供应商
 Note Test block diagram

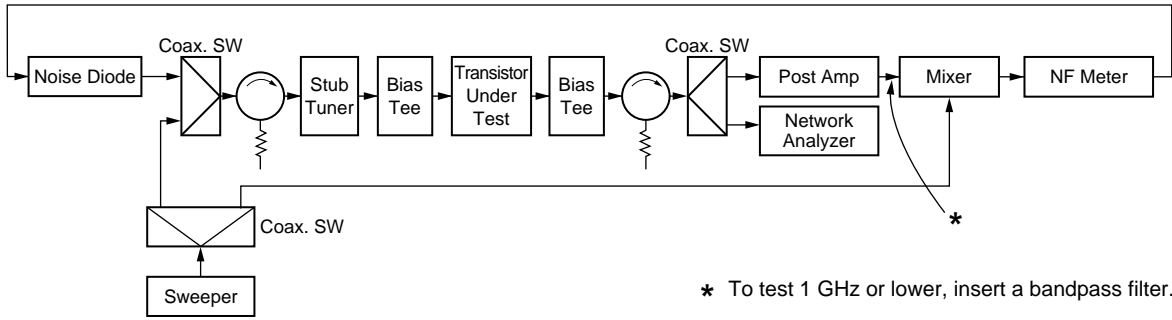

TYPICAL CHARACTERISTICS (T_A = 25 °C)

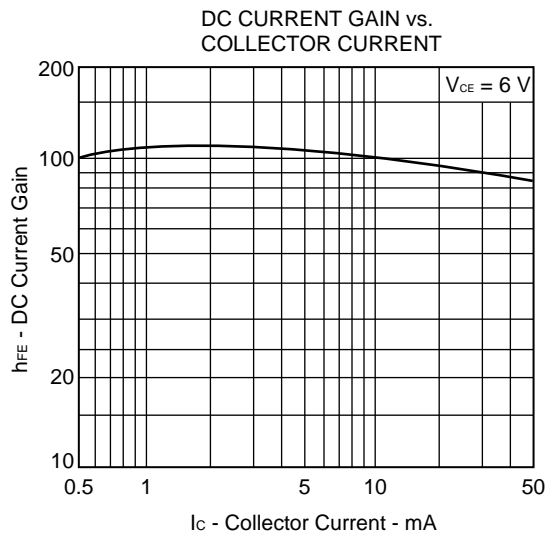
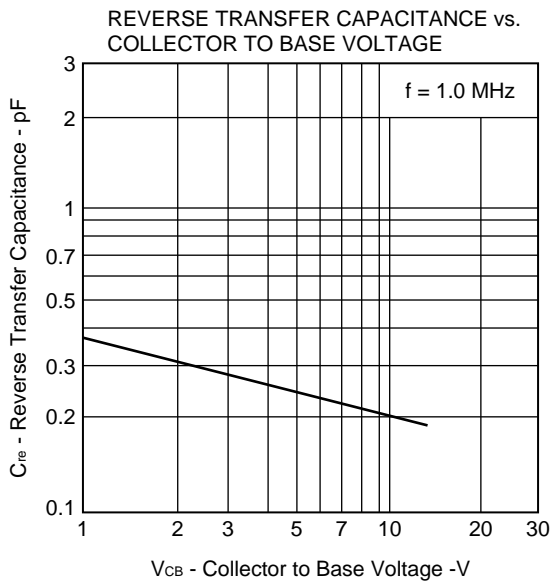
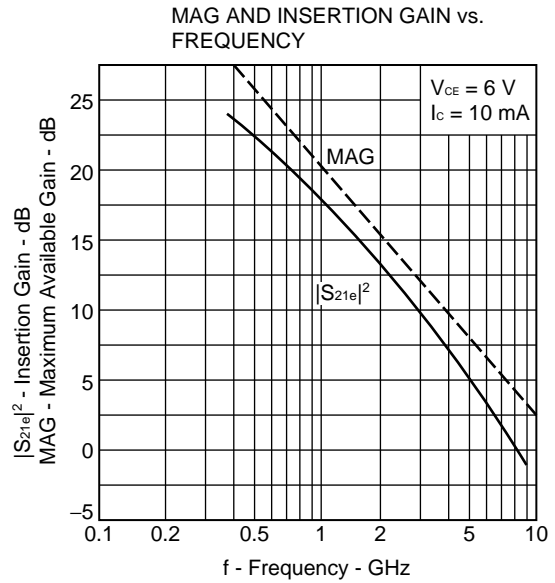
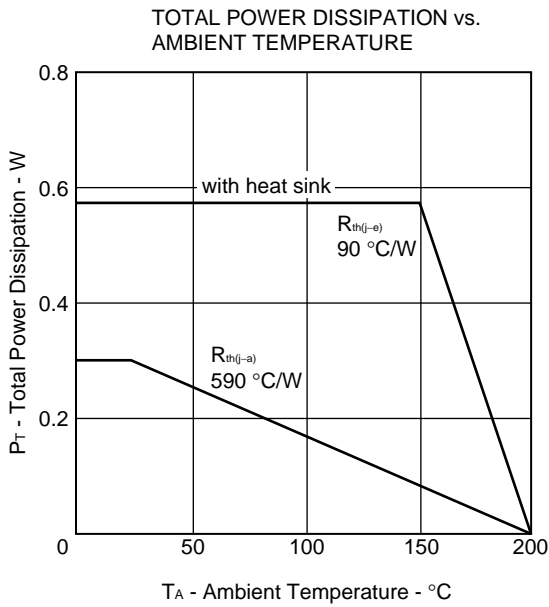

[查询"2SC3587"供应商](#)

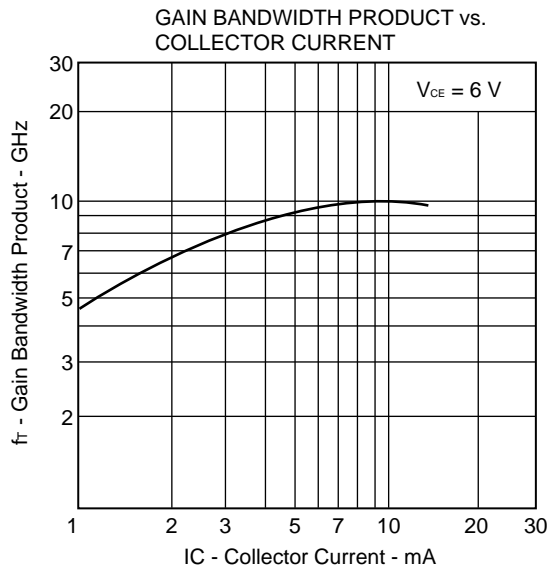
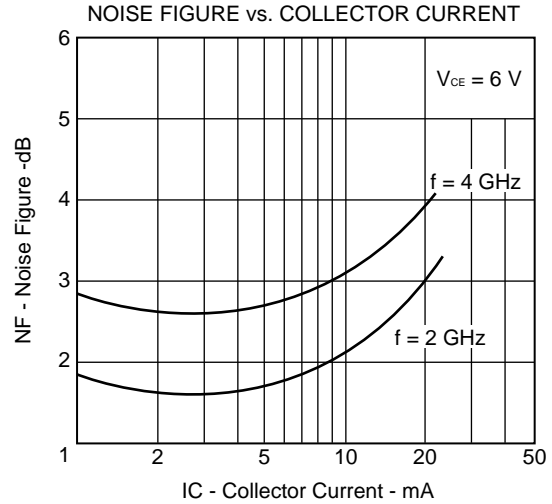
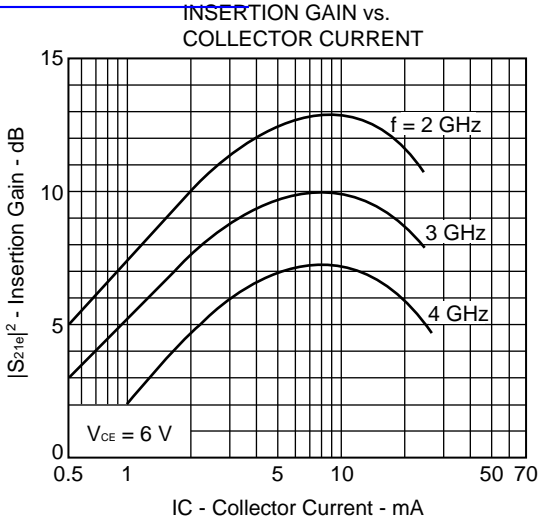

S PARAMETER

$V_{CE} = 6\text{ V}$, $I_C = 10\text{ mA}$, $Z_O = 50\ \Omega$

f (MHz)	$ S_{11} $	$\angle S_{11}$	$ S_{21} $	$\angle S_{21}$	$ S_{12} $	$\angle S_{12}$	$ S_{22} $	$\angle S_{22}$
500	.466	-82.1	13.209	120.8	.0288	50.9	.634	-25.0
1000	.322	-123.8	8.371	95.7	.0424	54.2	.610	-29.4
1500	.271	-153.7	5.672	78.7	.0561	54.5	.579	-33.5
2000	.256	-176.6	4.304	66.9	.0697	54.1	.549	-38.7
2500	.262	167.3	3.456	58.6	.0848	51.9	.531	-46.2
3000	.270	152.0	3.095	46.1	.0955	48.0	.507	-52.8
3500	.294	142.0	2.595	35.0	.106	43.2	.498	-61.0
4000	.327	129.7	2.231	27.6	.127	35.2	.500	-68.4

上海"2SC3587"供应商
S-PARAMETER

S_{11e}, S_{22e} – FREQUENCY

V_{CE} = 6 V
I_c = 10 mA
500 MHz Step

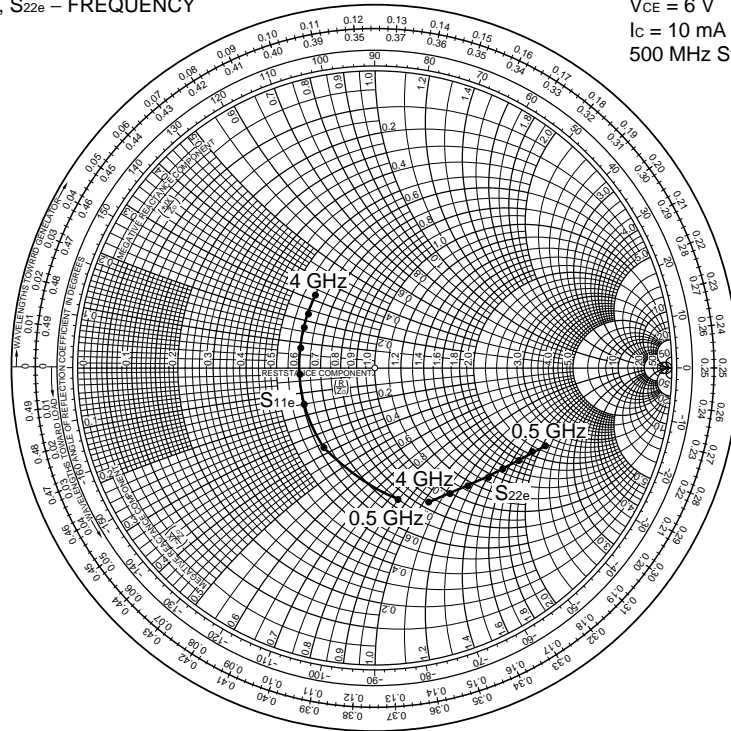

S₂₁ – FREQUENCY

V_{CE} = 6 V
I_c = 10 mA
500 MHz Step

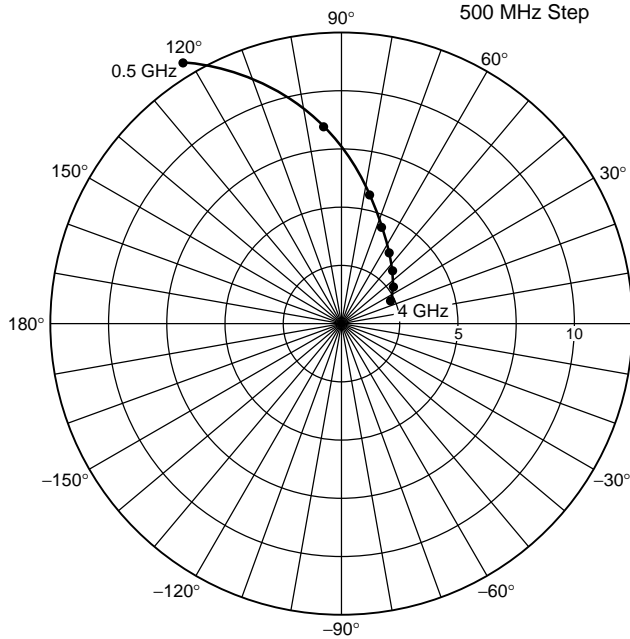

S₁₂ – FREQUENCY

V_{CE} = 6 V
I_c = 10 mA
500 MHz Step

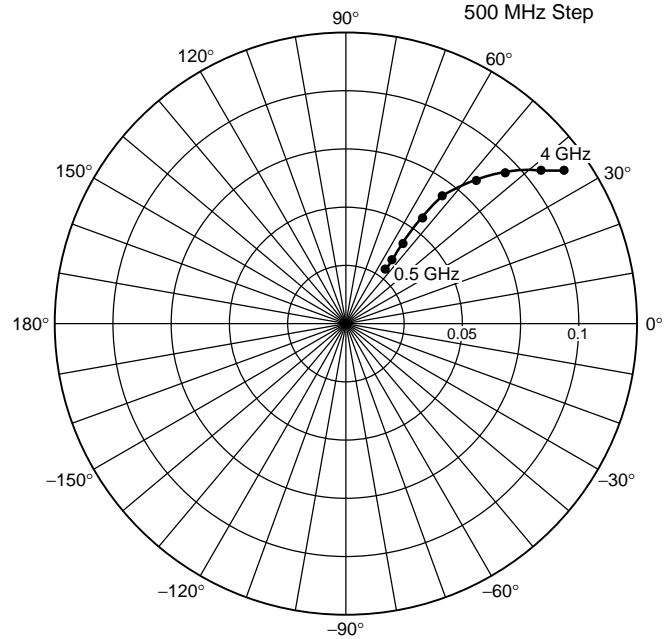

[查询"2SC3587"供应商](#)

MEMO

[查询"2SC3587"供应商](#)

MEMO

[查询"2SC3587"供应商](#)

MEMO

[查询"2SC3587"供应商](#)

The export of this product from Japan is prohibited without governmental license. To export or re-export this product from a country other than Japan may also be prohibited without a license from that country. Please call an NEC sales representative.

No part of this document may be copied or reproduced in any form or by any means without the prior written consent of NEC Corporation. NEC Corporation assumes no responsibility for any errors which may appear in this document.

NEC Corporation does not assume any liability for infringement of patents, copyrights or other intellectual property rights of third parties by or arising from use of a device described herein or any other liability arising from use of such device. No license, either express, implied or otherwise, is granted under any patents, copyrights or other intellectual property rights of NEC Corporation or others.

While NEC Corporation has been making continuous effort to enhance the reliability of its semiconductor devices, the possibility of defects cannot be eliminated entirely. To minimize risks of damage or injury to persons or property arising from a defect in an NEC semiconductor device, customers must incorporate sufficient safety measures in its design, such as redundancy, fire-containment, and anti-failure features.

NEC devices are classified into the following three quality grades:

"Standard", "Special", and "Specific". The Specific quality grade applies only to devices developed based on a customer designated "quality assurance program" for a specific application. The recommended applications of a device depend on its quality grade, as indicated below. Customers must check the quality grade of each device before using it in a particular application.

Standard: Computers, office equipment, communications equipment, test and measurement equipment, audio and visual equipment, home electronic appliances, machine tools, personal electronic equipment and industrial robots

Special: Transportation equipment (automobiles, trains, ships, etc.), traffic control systems, anti-disaster systems, anti-crime systems, safety equipment and medical equipment (not specifically designed for life support)

Specific: Aircrafts, aerospace equipment, submersible repeaters, nuclear reactor control systems, life support systems or medical equipment for life support, etc.

The quality grade of NEC devices is "Standard" unless otherwise specified in NEC's Data Sheets or Data Books. If customers intend to use NEC devices for applications other than those specified for Standard quality grade, they should contact an NEC sales representative in advance.

Anti-radioactive design is not implemented in this product.