

MRF6S9125NR1/NBR1 replaced by MRFE6S9125NR1/NBR1. Refer to Device Migration PCN12895 for more details.

RF Power Field Effect Transistors

N-Channel Enhancement-Mode Lateral MOSFETs

Designed for broadband commercial and industrial applications with frequencies up to 1000 MHz. The high gain and broadband performance of these devices make them ideal for large-signal, common-source amplifier applications in 28 volt base station equipment.

N-CDMA Application

- Typical Single-Carrier N-CDMA Performance: $V_{DD} = 28$ Volts, $I_{DQ} = 950$ mA, $P_{out} = 27$ Watt Avg., Full Frequency Band (865-960 MHz), IS-95 CDMA (Pilot, Sync, Paging, Traffic Codes 8 Through 13) Channel Bandwidth = 1.2288 MHz. PAR = 9.8 dB @ 0.01% Probability on CCDF.
 - Power Gain — 20.2 dB
 - Drain Efficiency — 31%
 - ACPR @ 750 kHz Offset = -47.1 dBc in 30 kHz Bandwidth

GSM EDGE Application

- Typical GSM EDGE Performance: $V_{DD} = 28$ Volts, $I_{DQ} = 700$ mA, $P_{out} = 60$ Watts Avg., Full Frequency Band (865-960 MHz or 921-960 MHz)
 - Power Gain — 20 dB
 - Drain Efficiency — 40%
 - Spectral Regrowth @ 400 kHz Offset = -63 dBc
 - Spectral Regrowth @ 600 kHz Offset = -78 dBc
 - EVM — 1.8% rms

GSM Application

- Typical GSM Performance: $V_{DD} = 28$ Volts, $I_{DQ} = 700$ mA, $P_{out} = 125$ Watts, Full Frequency Band (921-960 MHz)
 - Power Gain — 19 dB
 - Drain Efficiency — 62%
- Capable of Handling 10:1 VSWR, @ 28 Vdc, 880 MHz, 125 Watts CW Output Power

Features

- Characterized with Series Equivalent Large-Signal Impedance Parameters
- Internally Matched for Ease of Use
- Qualified Up to a Maximum of 32 V_{DD} Operation
- Integrated ESD Protection
- 225°C Capable Plastic Package
- N Suffix Indicates Lead-Free Terminations. RoHS Compliant.
- In Tape and Reel. R1 Suffix = 500 Units per 44 mm, 13 inch Reel.

Table 1. Maximum Ratings

Rating	Symbol	Value	Unit
Drain-Source Voltage	V_{DSS}	-0.5, +68	Vdc
Gate-Source Voltage	V_{GS}	-0.5, +12	Vdc
Storage Temperature Range	T_{stg}	-65 to +150	°C
Case Operating Temperature	T_C	150	°C
Operating Junction Temperature (1,2)	T_J	225	°C

- Continuous use at maximum temperature will affect MTTF.
- MTTF calculator available at <http://www.freescale.com/rf>. Select Software & Tools/Development Tools/Calculators to access MTTF calculators by product.

MRF6S9125NR1
MRF6S9125NBR1

865-960 MHz, 27 W AVG., 28 V
SINGLE N-CDMA, GSM EDGE
LATERAL N-CHANNEL
RF POWER MOSFETs

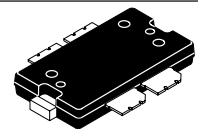

CASE 1486-03, STYLE 1
TO-270 WB-4
PLASTIC
MRF6S9125NR1

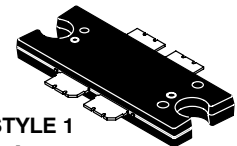

CASE 1484-04, STYLE 1
TO-272 WB-4
PLASTIC
MRF6S9125NBR1

ARCHIVE INFORMATION

ARCHIVE INFORMATION

Table 2. Thermal Characteristics

Characteristic	Symbol	Value (1,2)	Unit
Thermal Resistance, Junction to Case Case Temperature 80°C, 125 W CW Case Temperature 76°C, 27 W CW	$R_{\theta JC}$	0.44 0.45	°C/W

Table 3. ESD Protection Characteristics

Test Methodology	Class
Human Body Model (per JESD22-A114)	1B (Minimum)
Machine Model (per EIA/JESD22-A115)	C (Minimum)
Charge Device Model (per JESD22-C101)	IV (Minimum)

Table 4. Moisture Sensitivity Level

Test Methodology	Rating	Package Peak Temperature	Unit
Per JESD 22-A113, IPC/JEDEC J-STD-020	3	260	°C

Table 5. Electrical Characteristics ($T_C = 25^\circ\text{C}$ unless otherwise noted)

Characteristic	Symbol	Min	Typ	Max	Unit
----------------	--------	-----	-----	-----	------

Off Characteristics

Zero Gate Voltage Drain Leakage Current ($V_{DS} = 68\text{ Vdc}$, $V_{GS} = 0\text{ Vdc}$)	I_{DSS}	—	—	10	μAdc
Zero Gate Voltage Drain Leakage Current ($V_{DS} = 28\text{ Vdc}$, $V_{GS} = 0\text{ Vdc}$)	I_{DSS}	—	—	1	μAdc
Gate-Source Leakage Current ($V_{GS} = 5\text{ Vdc}$, $V_{DS} = 0\text{ Vdc}$)	I_{GSS}	—	—	1	μAdc

On Characteristics

Gate Threshold Voltage ($V_{DS} = 10\text{ Vdc}$, $I_D = 400\ \mu\text{Adc}$)	$V_{GS(th)}$	1	2.1	3	Vdc
Gate Quiescent Voltage ($V_{DD} = 28\text{ Vdc}$, $I_D = 950\ \text{mAdc}$, Measured in Functional Test)	$V_{GS(Q)}$	2	2.89	4	Vdc
Drain-Source On-Voltage ($V_{GS} = 10\text{ Vdc}$, $I_D = 2.74\ \text{Adc}$)	$V_{DS(on)}$	0.05	0.23	0.3	Vdc

Dynamic Characteristics ⁽³⁾

Reverse Transfer Capacitance ($V_{DS} = 28\text{ Vdc} \pm 30\ \text{mV(rms)ac}$ @ 1 MHz, $V_{GS} = 0\text{ Vdc}$)	C_{rss}	—	2	—	pF
Output Capacitance ($V_{DS} = 28\text{ Vdc} \pm 30\ \text{mV(rms)ac}$ @ 1 MHz, $V_{GS} = 0\text{ Vdc}$)	C_{oss}	—	60	—	pF

Functional Tests (In Freescale Test Fixture, 50 ohm system) $V_{DD} = 28\text{ Vdc}$, $I_{DQ} = 950\ \text{mA}$, $P_{out} = 27\ \text{W Avg}$. N-CDMA, $f = 880\ \text{MHz}$, Single-Carrier N-CDMA, 1.2288 MHz Channel Bandwidth Carrier. ACPR measured in 30 kHz Channel Bandwidth @ $\pm 750\ \text{kHz}$ Offset. PAR = 9.8 dB @ 0.01% Probability on CCDF.

Power Gain	G_{ps}	19	20.2	24	dB
Drain Efficiency	η_D	29	31	—	%
Adjacent Channel Power Ratio	ACPR	—	-47.1	-45	dBc
Input Return Loss	IRL	—	-16	-9	dB

1. MTTF calculator available at <http://www.freescale.com/rf>. Select Software & Tools/Development Tools/Calculators to access MTTF calculators by product.
2. Refer to AN1955, *Thermal Measurement Methodology of RF Power Amplifiers*. Go to <http://www.freescale.com/rf>. Select Documentation/Application Notes - AN1955.
3. Part is internally input matched.

(continued)

Table 5. Electrical Characteristics ($T_C = 25^\circ\text{C}$ unless otherwise noted) (continued)

Characteristic	Symbol	Min	Typ	Max	Unit
----------------	--------	-----	-----	-----	------

Typical GSM EDGE Performances (In Freescale GSM EDGE Test Fixture, 50 ohm system) $V_{DD} = 28\text{ Vdc}$, $I_{DQ} = 700\text{ mA}$, $P_{out} = 60\text{ W Avg.}$, 921-960 MHz, EDGE Modulation

Power Gain	G_{ps}	—	20	—	dB
Drain Efficiency	η_D	—	40	—	%
Error Vector Magnitude	EVM	—	1.8	—	% rms
Spectral Regrowth at 400 kHz Offset	SR1	—	-63	—	dBc
Spectral Regrowth at 600 kHz Offset	SR2	—	-78	—	dBc

Typical CW Performances (In Freescale GSM Test Fixture, 50 ohm system) $V_{DD} = 28\text{ Vdc}$, $I_{DQ} = 700\text{ mA}$, $P_{out} = 125\text{ W}$, 921-960 MHz

Power Gain	G_{ps}	—	19	—	dB
Drain Efficiency	η_D	—	62	—	%
Input Return Loss	IRL	—	-12	—	dB
P_{out} @ 1 dB Compression Point, CW ($f = 880\text{ MHz}$)	P1dB	—	125	—	W

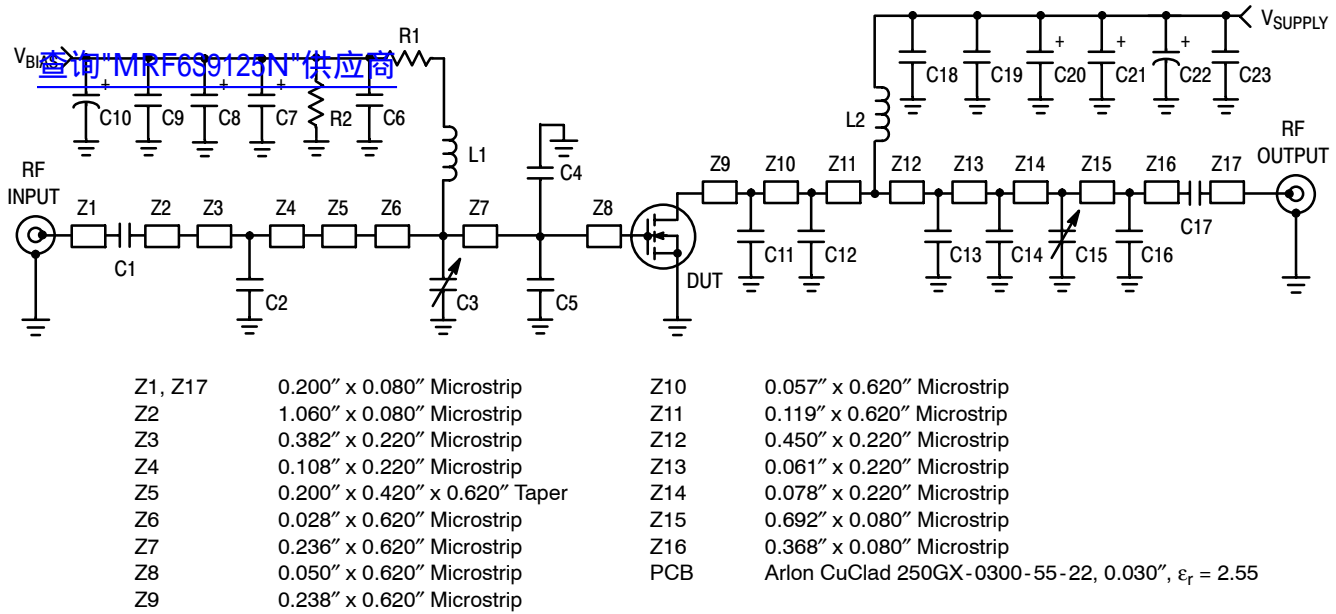

Figure 1. MRF6S9125NR1(NBR1) Test Circuit Schematic

Table 6. MRF6S9125NR1(NBR1) Test Circuit Component Designations and Values

Part	Description	Part Number	Manufacturer
C1	20 pF Chip Capacitor	ATC100B200FT500XT	ATC
C2	6.2 pF Chip Capacitor	ATC100B6R2BT500XT	ATC
C3, C15	0.8-8.0 pF Variable Capacitors, Gigatrim	27291SL	Johanson
C4, C5	11 pF Chip Capacitors	ATC100B110FT500XT	ATC
C6, C18, C19	0.56 μ F, 50 V Chip Capacitors	C1825C564J5RAC	Kemet
C7, C8	47 μ F, 16 V Tantalum Capacitors	T491D476K016AT	Kemet
C9, C23	47 pF Chip Capacitors	ATC700B470FT500XT	ATC
C10	100 μ F, 50 V Electrolytic Capacitor	MCHT101M1HB-1017-RF	Multicomp
C11, C12	12 pF Chip Capacitors	ATC100B120FT500XT	ATC
C13, C14	5.1 pF Chip Capacitors	ATC100B5R1BT500XT	ATC
C16	0.3 pF Chip Capacitor	ATC700B0R3BT500XT	ATC
C17	39 pF Chip Capacitor	ATC700B390FT500XT	ATC
C20, C21	22 μ F, 35 V Tantalum Capacitors	T491X226K035AT	Kemet
C22	470 μ F, 63 V Electrolytic Capacitor	ESME630ELL471MK25S	United Chemi-Con
L1	7.15 nH Inductor	1606-7J	CoilCraft
L2	8.0 nH Inductor	A03T	CoilCraft
R1	15 Ω , 1/3 W Chip Resistor	CRCW121015R0FKEA	Vishay
R2	560 k Ω , 1/4 W Chip Resistor	CRCW12065603FKEA	Vishay

查询"MRF6S9125N"供应商

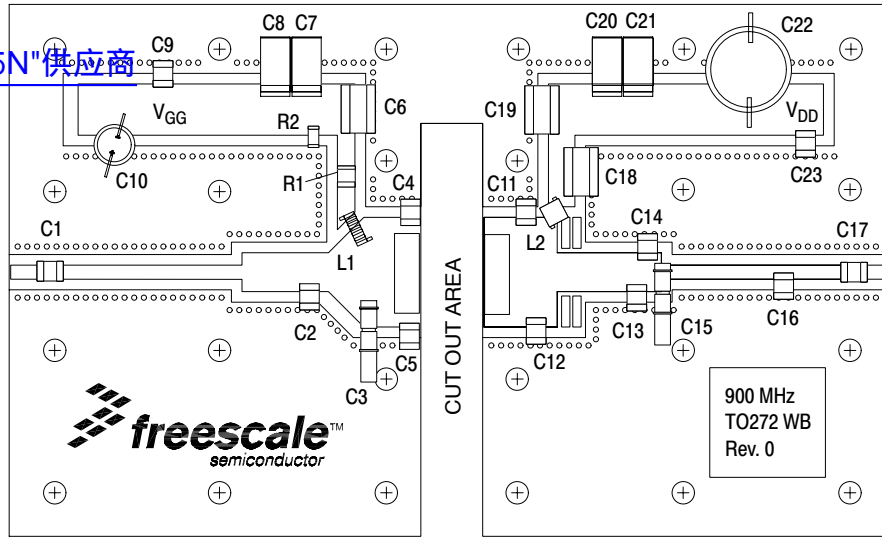

Figure 2. MRF6S9125NR1(NBR1) Test Circuit Component Layout

ARCHIVE INFORMATION

ARCHIVE INFORMATION

TYPICAL CHARACTERISTICS

查询"MRF6S9125N"供应商

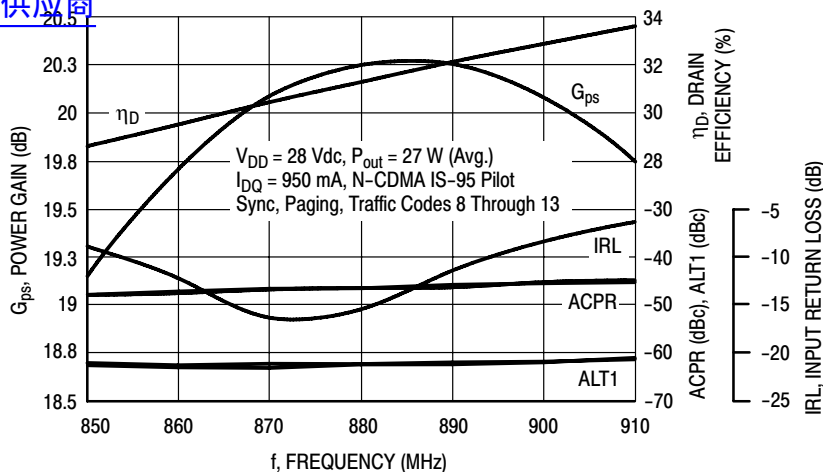

Figure 3. Single-Carrier N-CDMA Broadband Performance @ $P_{out} = 27$ Watts Avg.

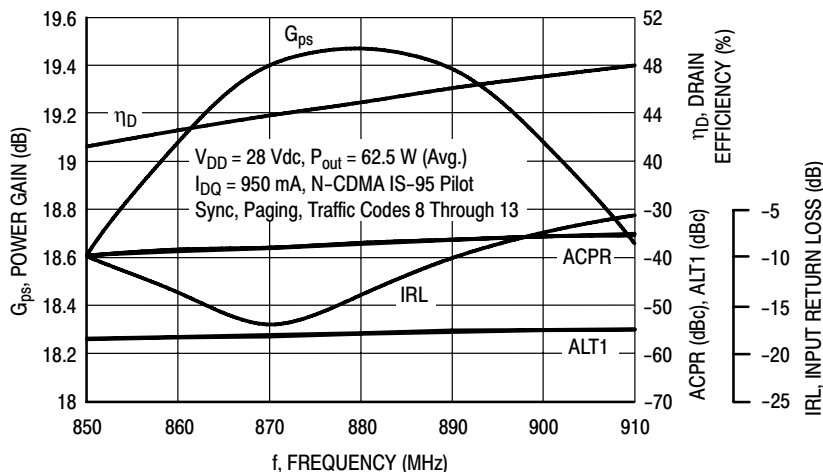

Figure 4. Single-Carrier N-CDMA Broadband Performance @ $P_{out} = 62.5$ Watts Avg.

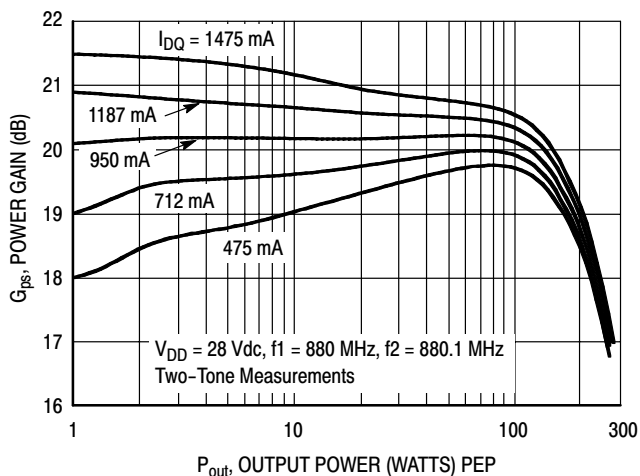

Figure 5. Two-Tone Power Gain versus Output Power

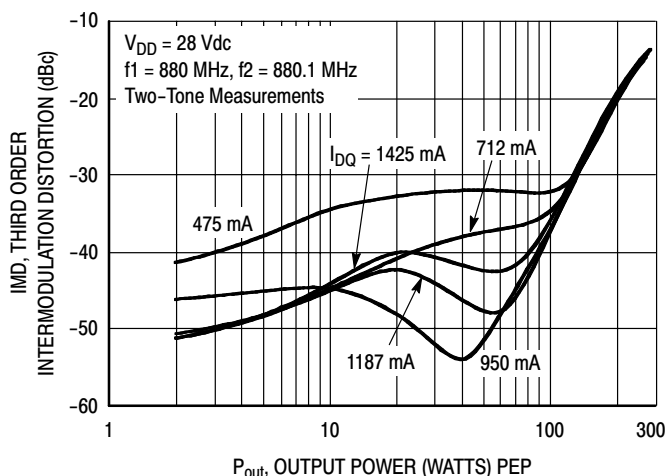

Figure 6. Third Order Intermodulation Distortion versus Output Power

ARCHIVE INFORMATION

ARCHIVE INFORMATION

TYPICAL CHARACTERISTICS

查询"MRF6S9125N"供应商

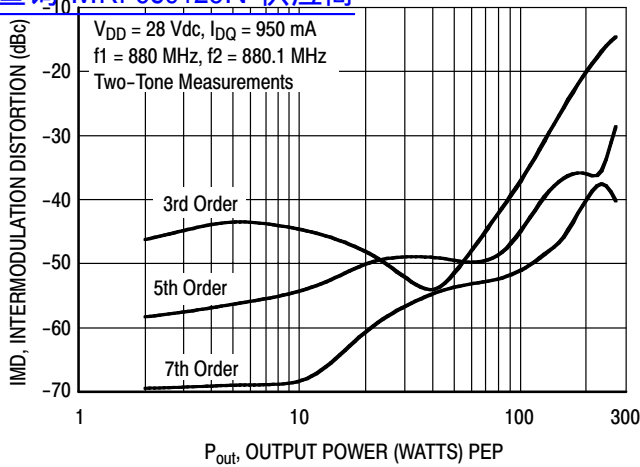

Figure 7. Intermodulation Distortion Products versus Output Power

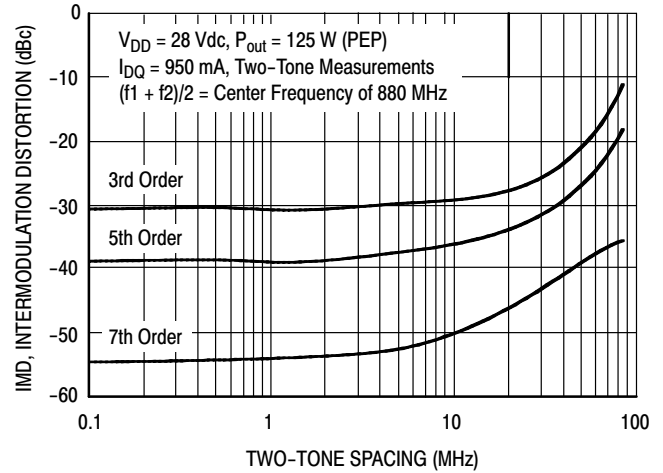

Figure 8. Intermodulation Distortion Products versus Tone Spacing

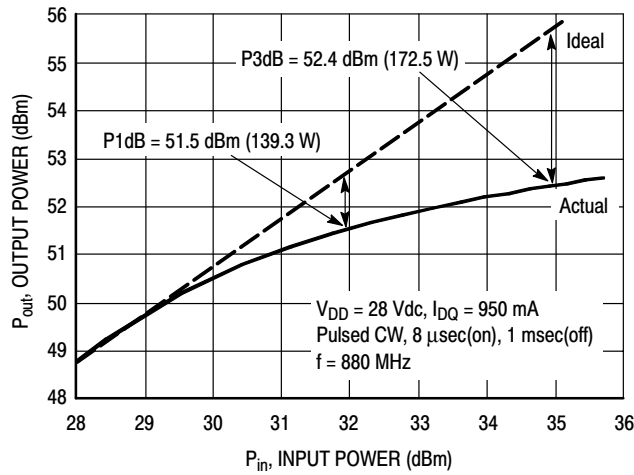

Figure 9. Pulsed CW Output Power versus Input Power

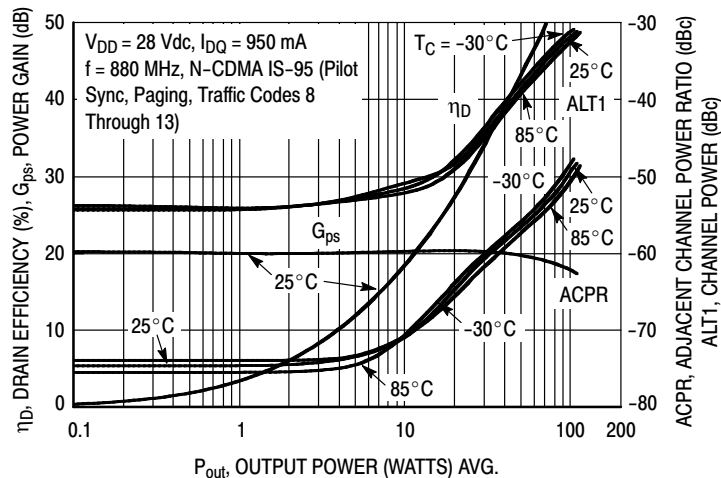

Figure 10. Single-Carrier N-CDMA ACPR, ALT1, Power Gain and Drain Efficiency versus Output Power

ARCHIVE INFORMATION

ARCHIVE INFORMATION

TYPICAL CHARACTERISTICS

查询"MRF6S9125N"供应商

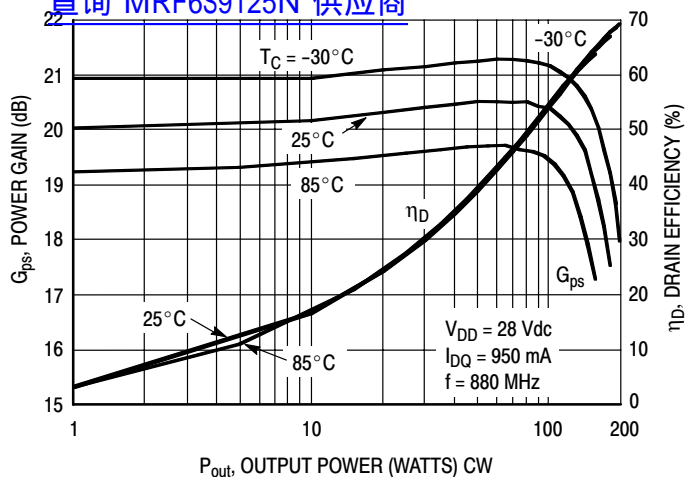

Figure 11. Power Gain and Drain Efficiency versus CW Output Power

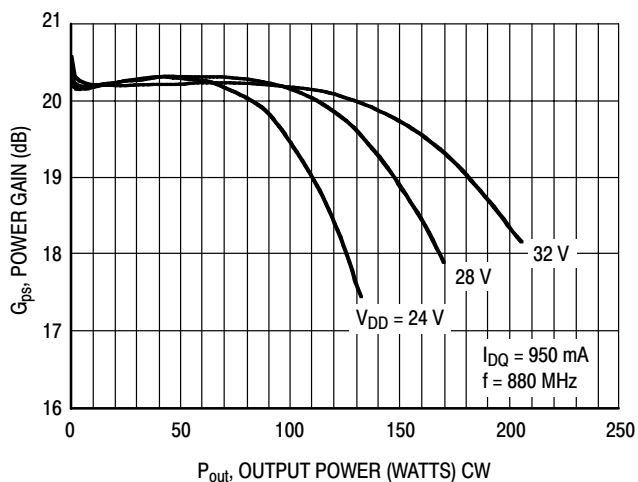
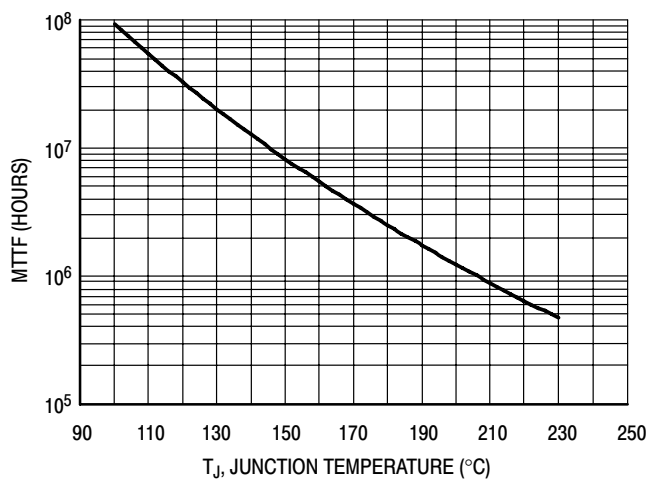

Figure 12. Power Gain versus Output Power



This above graph displays calculated MTTF in hours when the device is operated at $V_{DD} = 28$ Vdc, $P_{out} = 27$ W Avg., and $\eta_D = 31\%$.

MTTF calculator available at <http://www.freescale.com/rf>. Select Software & Tools/Development Tools/Calculators to access MTTF calculators by product.

Figure 13. MTTF Factor versus Junction Temperature

ARCHIVE INFORMATION

ARCHIVE INFORMATION

N-CDMA TEST SIGNAL

[查询"MRF6S9125N"供应商](#)

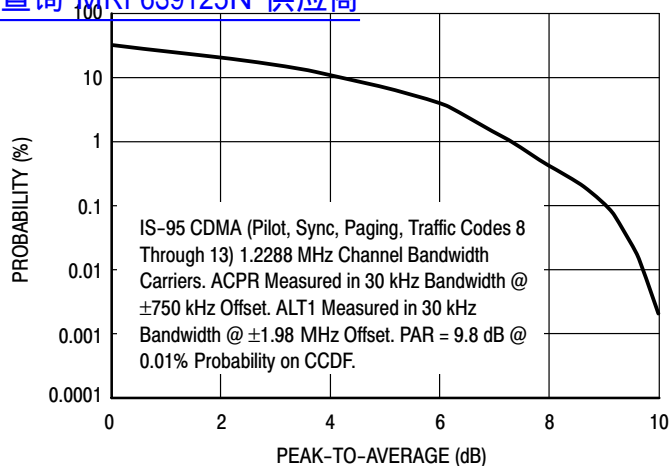

Figure 14. Single-Carrier CCDF N-CDMA

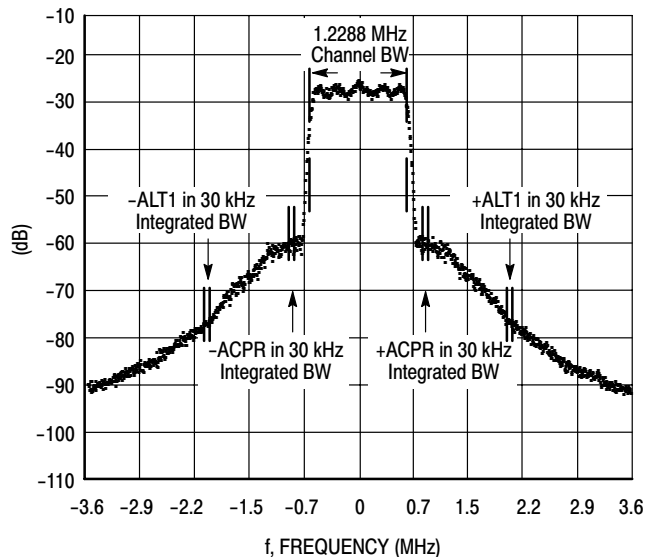
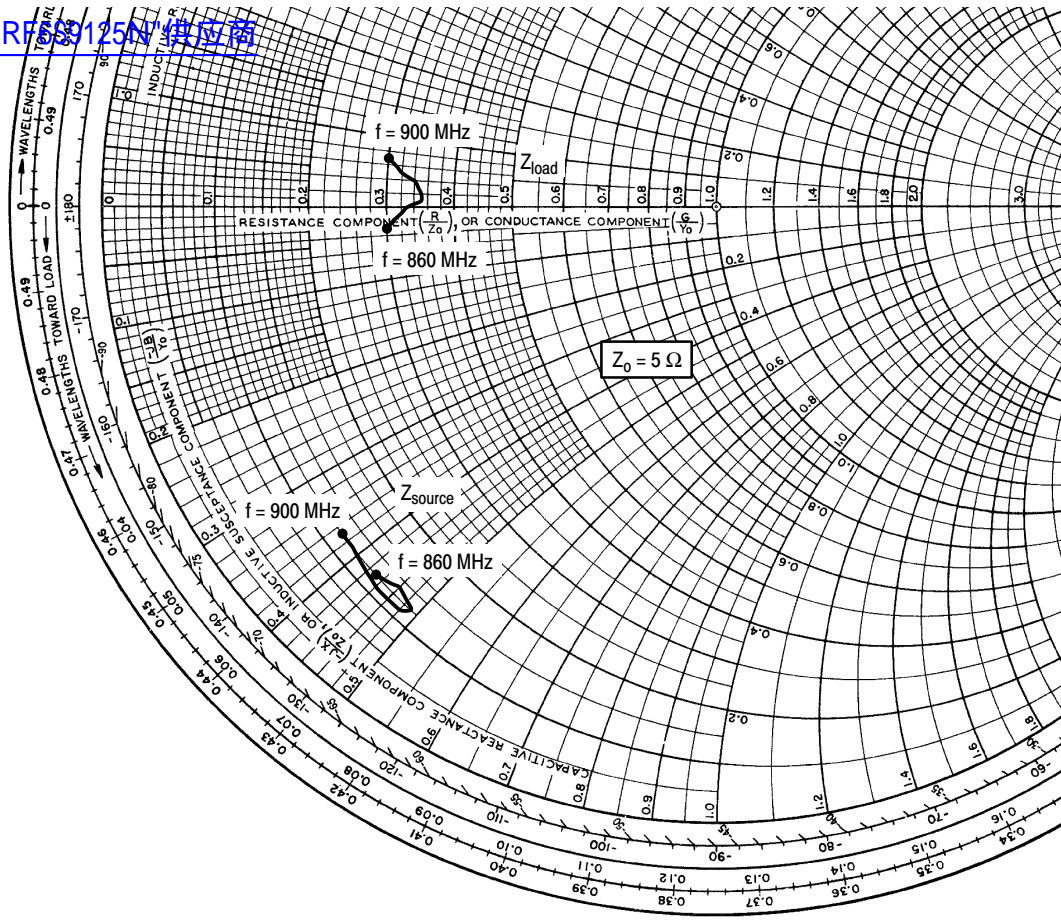

Figure 15. Single-Carrier N-CDMA Spectrum

ARCHIVE INFORMATION

ARCHIVE INFORMATION

查询"MRFS9125N"供应商



V_{DD} = 28 Vdc, I_{DQ} = 950 mA, P_{out} = 27 W Avg.

f MHz	Z _{source} Ω	Z _{load} Ω
860	0.62 - j2.13	1.48 - j0.14
865	0.64 - j2.31	1.56 - j0.09
870	0.62 - j2.45	1.66 - j0.02
875	0.59 - j2.43	1.73 + j0.04
880	0.57 - j2.42	1.74 + j0.11
885	0.54 - j2.36	1.68 + j0.19
890	0.57 - j2.18	1.61 + j0.25
895	0.58 - j1.94	1.52 + j0.33
900	0.59 - j1.86	1.48 + j0.37

Z_{source} = Test circuit impedance as measured from gate to ground.

Z_{load} = Test circuit impedance as measured from drain to ground.

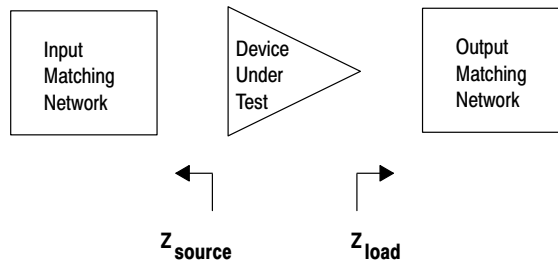
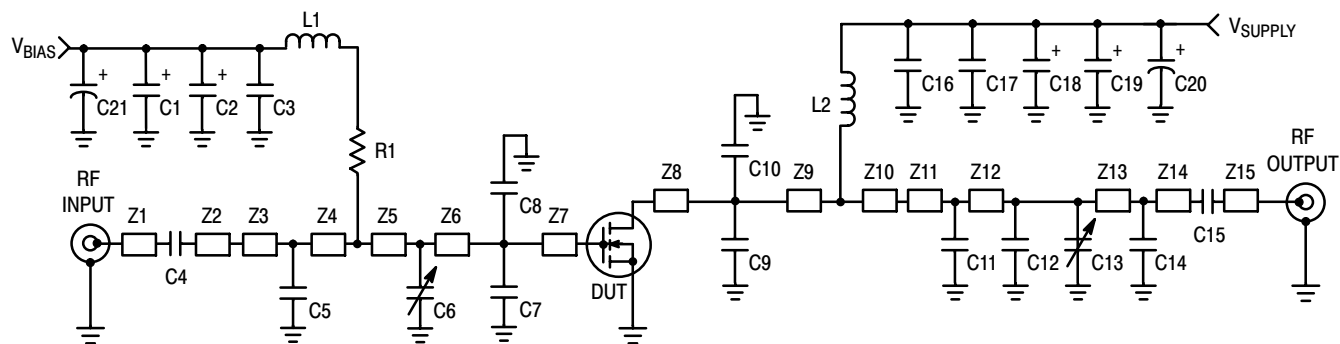

Figure 16. Series Equivalent Source and Load Impedance

EDGE CHARACTERIZATION

[查询"MRF6S9125N"供应商](#)



Z1, Z15	0.150" x 0.080" Microstrip	Z9	0.620" x 0.100" x 0.420" Taper
Z2	1.050" x 0.080" Microstrip	Z10	0.420" x 0.100" x 0.220" Taper
Z3	0.330" x 0.220" Microstrip	Z11	0.325" x 0.220" Microstrip
Z4	0.220" x 0.100" x 0.420" Taper	Z12	0.040" x 0.220" Microstrip
Z5	0.420" x 0.100" x 0.620" Taper	Z13	0.475" x 0.080" Microstrip
Z6	0.200" x 0.620" Microstrip	Z14	0.400" x 0.080" Microstrip
Z7, Z8	0.040" x 0.620" Microstrip	PCB	Arlon CuClad 250GX-0300-55-22, 0.030", $\epsilon_r = 2.55$

Figure 17. MRF6S9125NR1(NBR1) Test Circuit Schematic

Table 7. MRF6S9125NR1(NBR1) Test Circuit Component Designations and Values

Part	Description	Part Number	Manufacturer
C1, C2	47 μ F, 16 V Tantalum Capacitors	T491D476K016AT	Kemet
C3, C16, C17	0.56 μ F, 50 V Chip Capacitors	C1825C564J5GAC	Kemet
C4	20 pF Chip Capacitor	ATC100B200FT500XT	ATC
C5, C7, C8	6.2 pF Chip Capacitors	ATC100B6R2BT500XT	ATC
C6, C13	0.8-8.0 pF Variable Capacitors, Gigatrim	27291SL	Johanson Dielectrics
C9, C10	11 pF Chip Capacitors	ATC100B110FT500XT	ATC
C11	5.1 pF Chip Capacitor	ATC100B5R1BT500XT	ATC
C12	4.7 pF Chip Capacitor	ATC100B4R7BT500XT	ATC
C14	0.3 pF Chip Capacitor	ATC700B0R3BT500XT	ATC
C15	39 pF Chip Capacitor	ATC700B390FT500XT	ATC
C18, C19	22 μ F, 35 V Tantalum Capacitors	T491X226K035AT	Kemet
C20	470 μ F, 63 V Electrolytic Capacitor	ESME630ELL471MK25S	United Chemi-Con
C21	100 μ F, 50 V Electrolytic Capacitor	MCHT101M1HB-1017-RF	Multicomp
L1	7.15 nH Inductor	1606-7	Coilcraft
L2	8 nH Inductor	A03T-5	Coilcraft
R1	15 Ω , 1/4 W Chip Resistor	CRCW120615R0FKEA	Vishay

EDGE CHARACTERIZATION

[查询"MRF6S9125N"供应商](#)

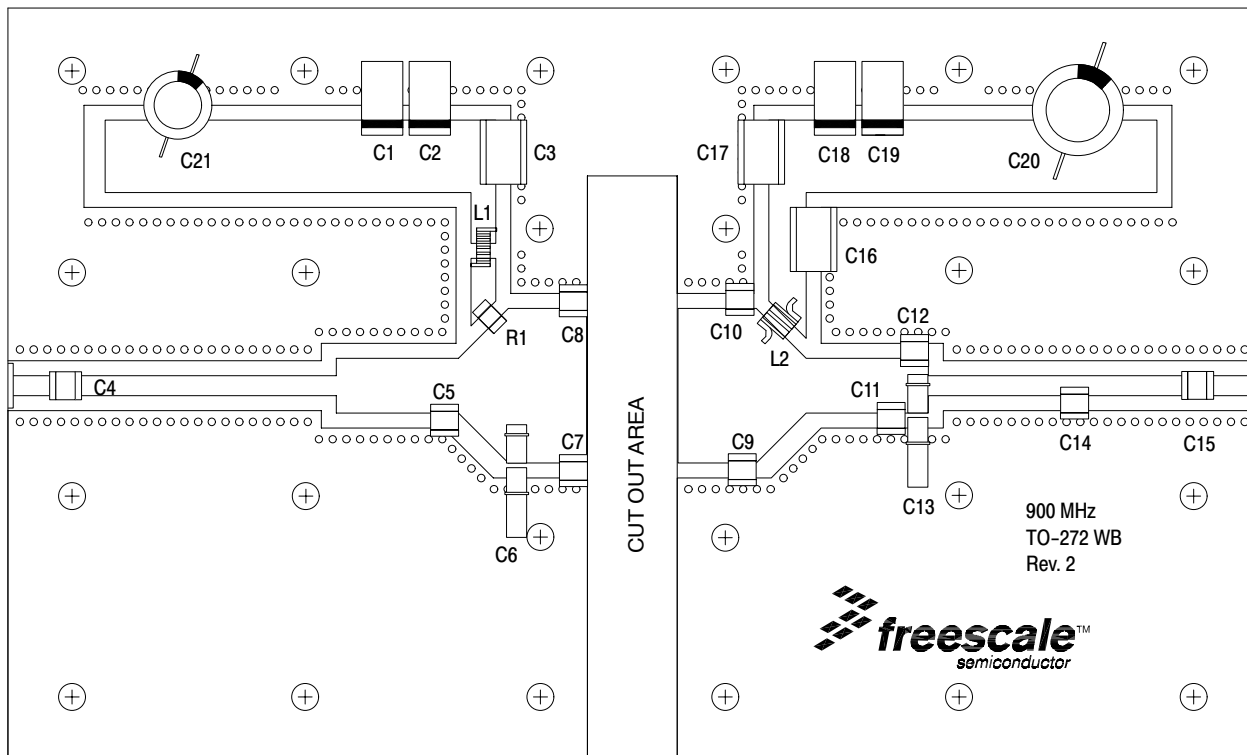

Figure 18. MRF6S9125NR1(NBR1) Test Circuit Component Layout

ARCHIVE INFORMATION

ARCHIVE INFORMATION

EDGE CHARACTERIZATION

[查询"MRF6S9125N"供应商](#)

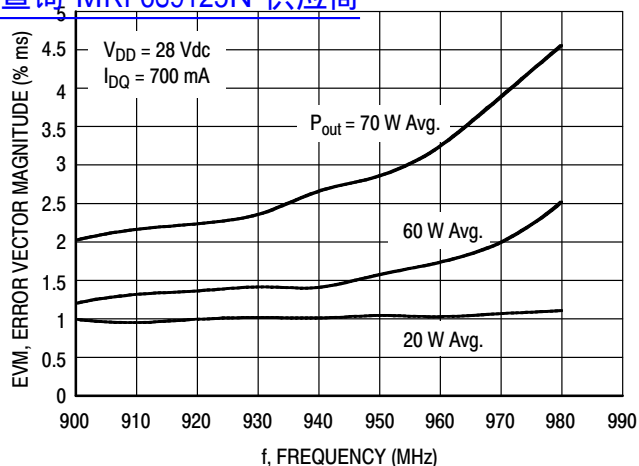

Figure 19. EVM versus Frequency

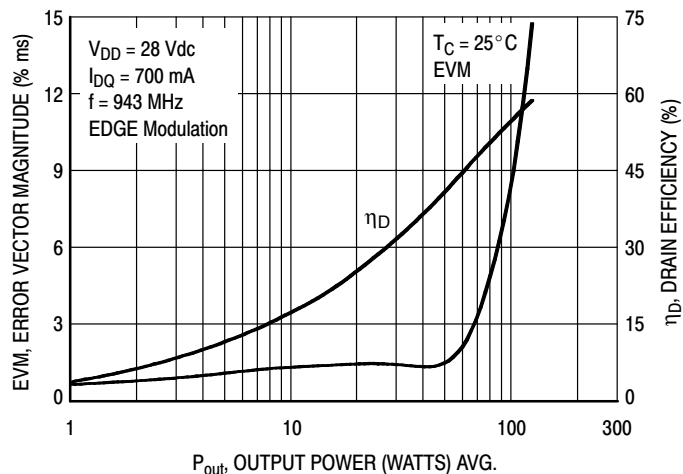

Figure 20. EVM and Drain Efficiency versus Output Power

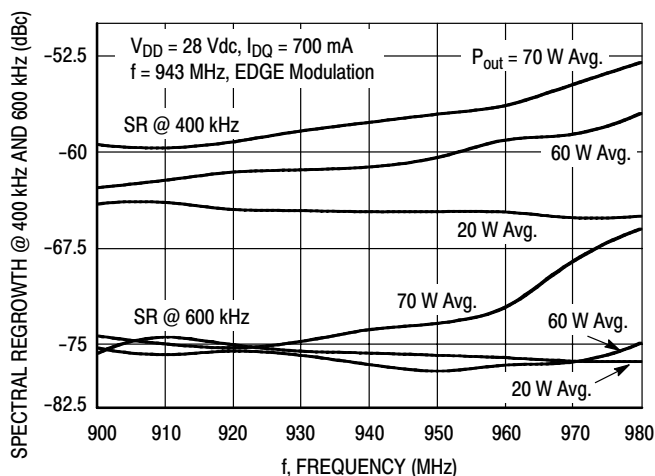

Figure 21. Spectral Regrowth at 400 kHz and 600 kHz versus Frequency

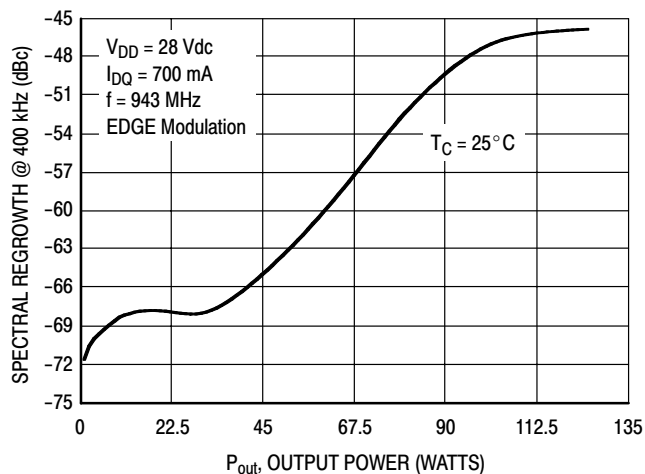

Figure 22. Spectral Regrowth at 400 kHz versus Output Power

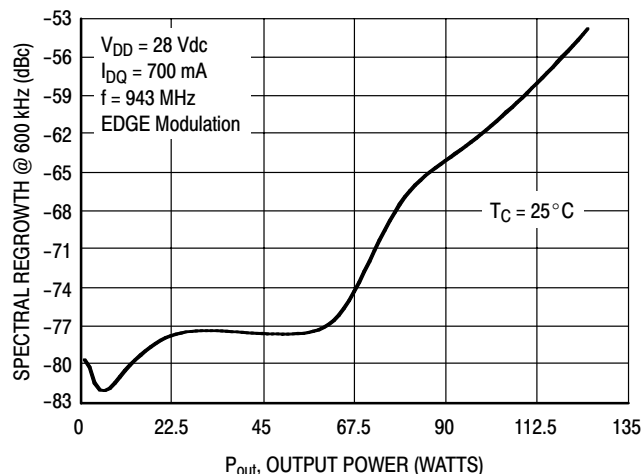

Figure 23. Spectral Regrowth at 600 kHz versus Output Power

ARCHIVE INFORMATION

ARCHIVE INFORMATION

EDGE CHARACTERIZATION TEST SIGNAL

[查询"MRF6S9125N"供应商](#)

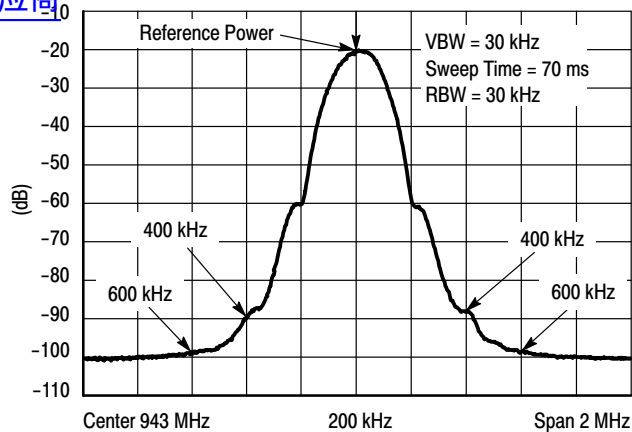
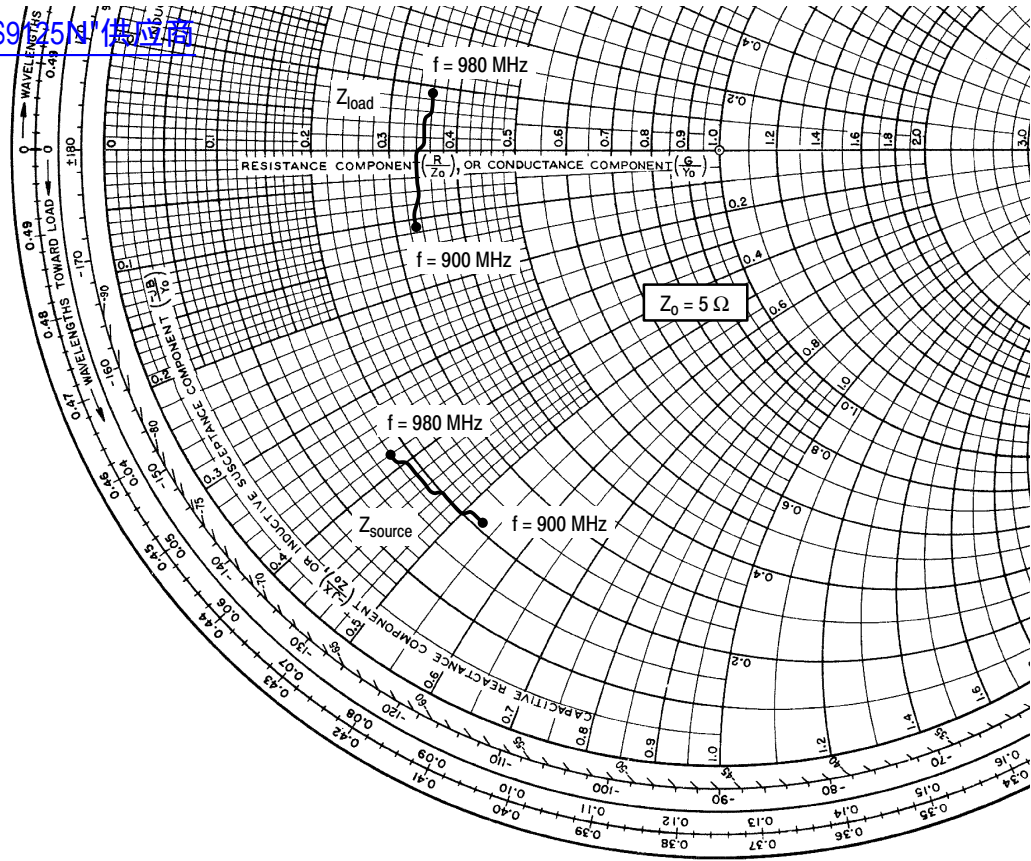

Figure 24. EDGE Spectrum

ARCHIVE INFORMATION

ARCHIVE INFORMATION

查询"MRF6S9125N" 传应商



$V_{DD} = 28 \text{ Vdc}$, $I_{DQ} = 700 \text{ mA}$, $P_{out} = 60 \text{ W Avg.}$

f MHz	Z _{source} Ω	Z _{load} Ω
900	1.04 - j2.65	1.66 - j0.56
905	1.04 - j2.60	1.66 - j0.50
910	1.03 - j2.55	1.67 - j0.43
915	1.02 - j2.51	1.68 - j0.37
920	1.01 - j2.46	1.68 - j0.31
925	1.01 - j2.41	1.69 - j0.24
930	1.00 - j2.36	1.70 - j0.18
935	0.98 - j2.32	1.70 - j0.12
940	0.97 - j2.27	1.71 - j0.05
945	0.96 - j2.22	1.72 - j0.00
950	0.95 - j2.17	1.73 + j0.07
955	0.94 - j2.12	1.74 + j0.14
960	0.94 - j2.08	1.76 + j0.20
965	0.93 - j2.03	1.77 + j0.26
970	0.93 - j1.99	1.79 + j0.32
975	0.92 - j1.94	1.80 + j0.39
980	0.92 - j1.90	1.82 + j0.45

Z_{source} = Test circuit impedance as measured from gate to ground.

Z_{load} = Test circuit impedance as measured from drain to ground.

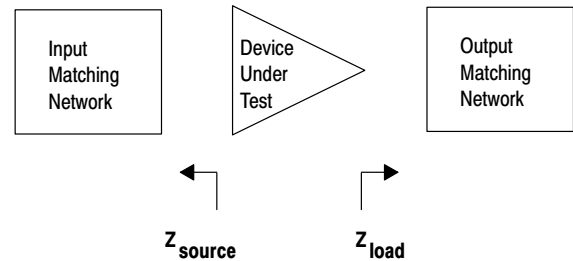
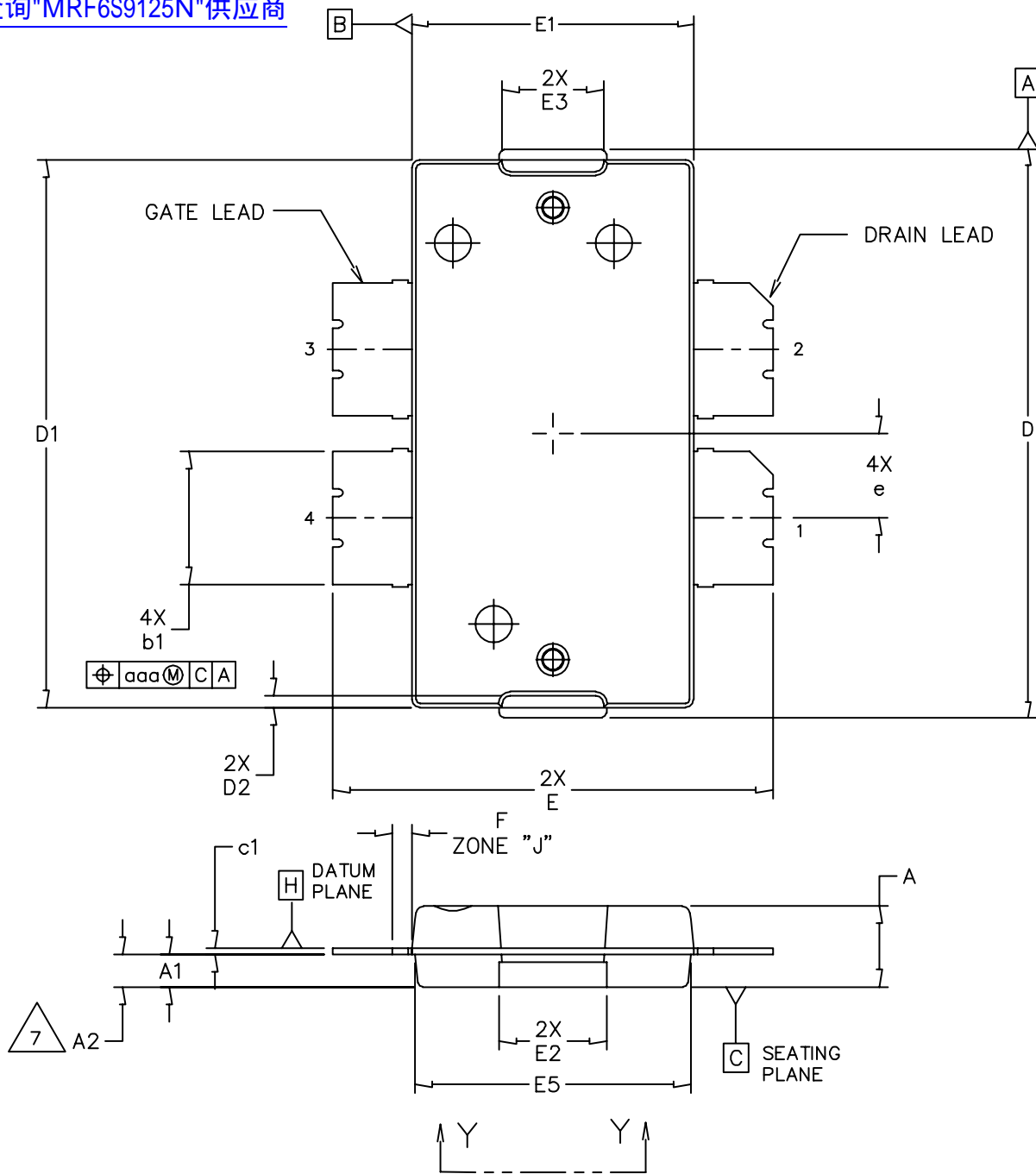

Figure 25. Series Equivalent Source and Load Impedance for EDGE Characterization Tests

PACKAGE DIMENSIONS

[查询"MRF6S9125N"供应商](#)



ARCHIVE INFORMATION

ARCHIVE INFORMATION

© FREESCALE SEMICONDUCTOR, INC. ALL RIGHTS RESERVED.		MECHANICAL OUTLINE	PRINT VERSION NOT TO SCALE
TITLE: TO-270 4 LEAD, WIDE BODY		DOCUMENT NO: 98ASA10577D	REV: D
		CASE NUMBER: 1486-03	13 AUG 2007
		STANDARD: NON-JEDEC	

[查询"MRF6S9125N"供应商](#)

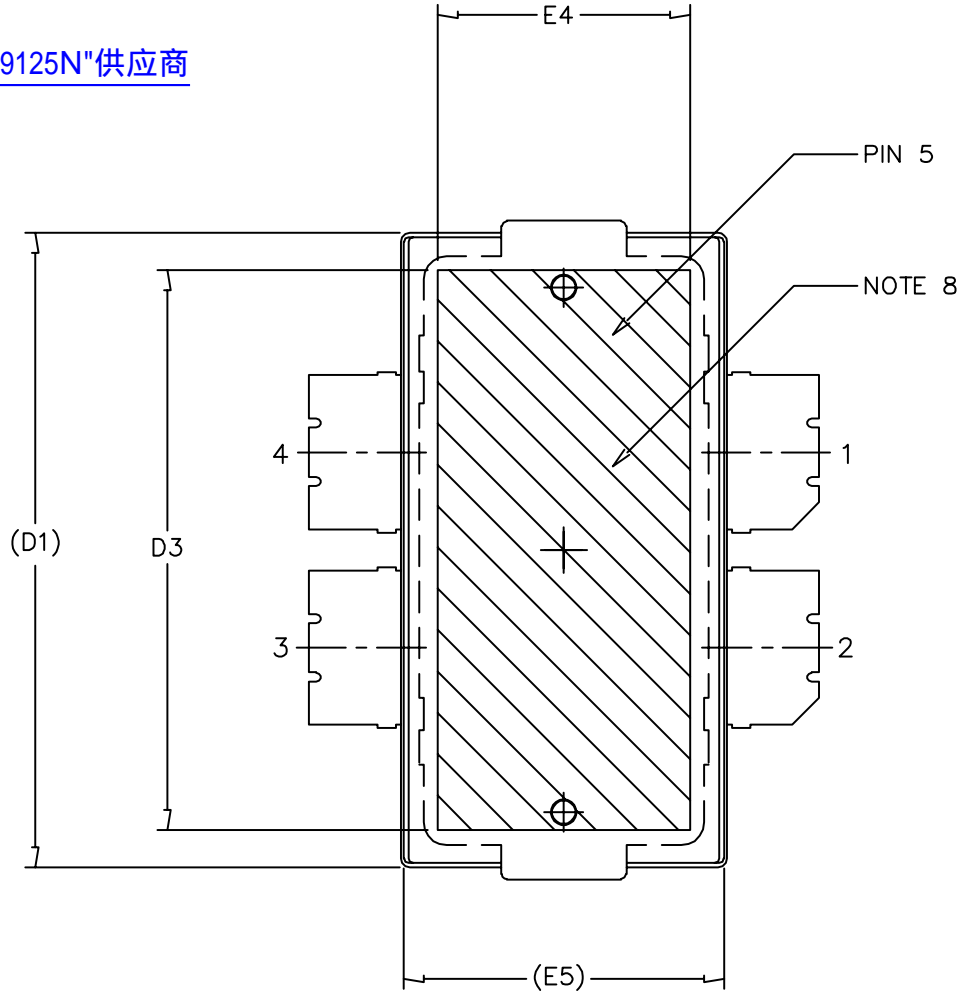

ARCHIVE INFORMATION

ARCHIVE INFORMATION

© FREESCALE SEMICONDUCTOR, INC. ALL RIGHTS RESERVED.	MECHANICAL OUTLINE	PRINT VERSION NOT TO SCALE	
TITLE: TO-270 4 LEAD, WIDE BODY	DOCUMENT NO: 98ASA10577D	REV: D	
	CASE NUMBER: 1486-03	13 AUG 2007	
	STANDARD: NON-JEDEC		

MRF6S9125NR1 MRF6S9125NBR1

NOTES:

1. CONTROLLING DIMENSION: INCH
[查询"MRF6S9125N"供应商](#)
2. INTERPRET DIMENSIONS AND TOLERANCES PER ASME Y14.5M-1994.
3. DATUM PLANE -H- IS LOCATED AT THE TOP OF LEAD AND IS COINCIDENT WITH THE LEAD WHERE THE LEAD EXITS THE PLASTIC BODY AT THE TOP OF THE PARTING LINE.
4. DIMENSIONS "D" AND "E1" DO NOT INCLUDE MOLD PROTRUSION. ALLOWABLE PROTRUSION IS .006 PER SIDE. DIMENSIONS "D" AND "E1" DO INCLUDE MOLD MISMATCH AND ARE DETERMINED AT DATUM PLANE -H-.
5. DIMENSIONS "b1" DOES NOT INCLUDE DAMBAR PROTRUSION. ALLOWABLE DAMBAR PROTRUSION SHALL BE .005 TOTAL IN EXCESS OF THE "b1" DIMENSION AT MAXIMUM MATERIAL CONDITION.
6. DATUMS -A- AND -B- TO BE DETERMINED AT DATUM PLANE -H-.
7. DIMENSION A2 APPLIES WITHIN ZONE "J" ONLY.
8. HATCHING REPRESENTS THE EXPOSED AREA OF THE HEAT SLUG.

STYLE 1:

PIN 1 - DRAIN PIN 2 - DRAIN
 PIN 3 - GATE PIN 4 - GATE
 PIN 5 - SOURCE

ARCHIVE INFORMATION

ARCHIVE INFORMATION

DIM	INCH		MILLIMETER		DIM	INCH		MILLIMETER	
	MIN	MAX	MIN	MAX		MIN	MAX	MIN	MAX
A	.100	.104	2.54	2.64	F	.025 BSC		0.64 BSC	
A1	.039	.043	0.99	1.09	b1	.164	.170	4.17	4.32
A2	.040	.042	1.02	1.07	c1	.007	.011	.18	.28
D	.712	.720	18.08	18.29	e	.106 BSC		2.69 BSC	
D1	.688	.692	17.48	17.58	aaa	.004		.10	
D2	.011	.019	0.28	0.48					
D3	.600	---	15.24	---					
E	.551	.559	14	14.2					
E1	.353	.357	8.97	9.07					
E2	.132	.140	3.35	3.56					
E3	.124	.132	3.15	3.35					
E4	.270	---	6.86	---					
E5	.346	.350	8.79	8.89					

© FREESCALE SEMICONDUCTOR, INC. ALL RIGHTS RESERVED.		MECHANICAL OUTLINE		PRINT VERSION NOT TO SCALE	
TITLE: TO-270 4 LEAD WIDE BODY			DOCUMENT NO: 98ASA10577D		REV: D
			CASE NUMBER: 1486-03		13 AUG 2007
			STANDARD: NON-JEDEC		

查询"MRF6S9125N"供应商

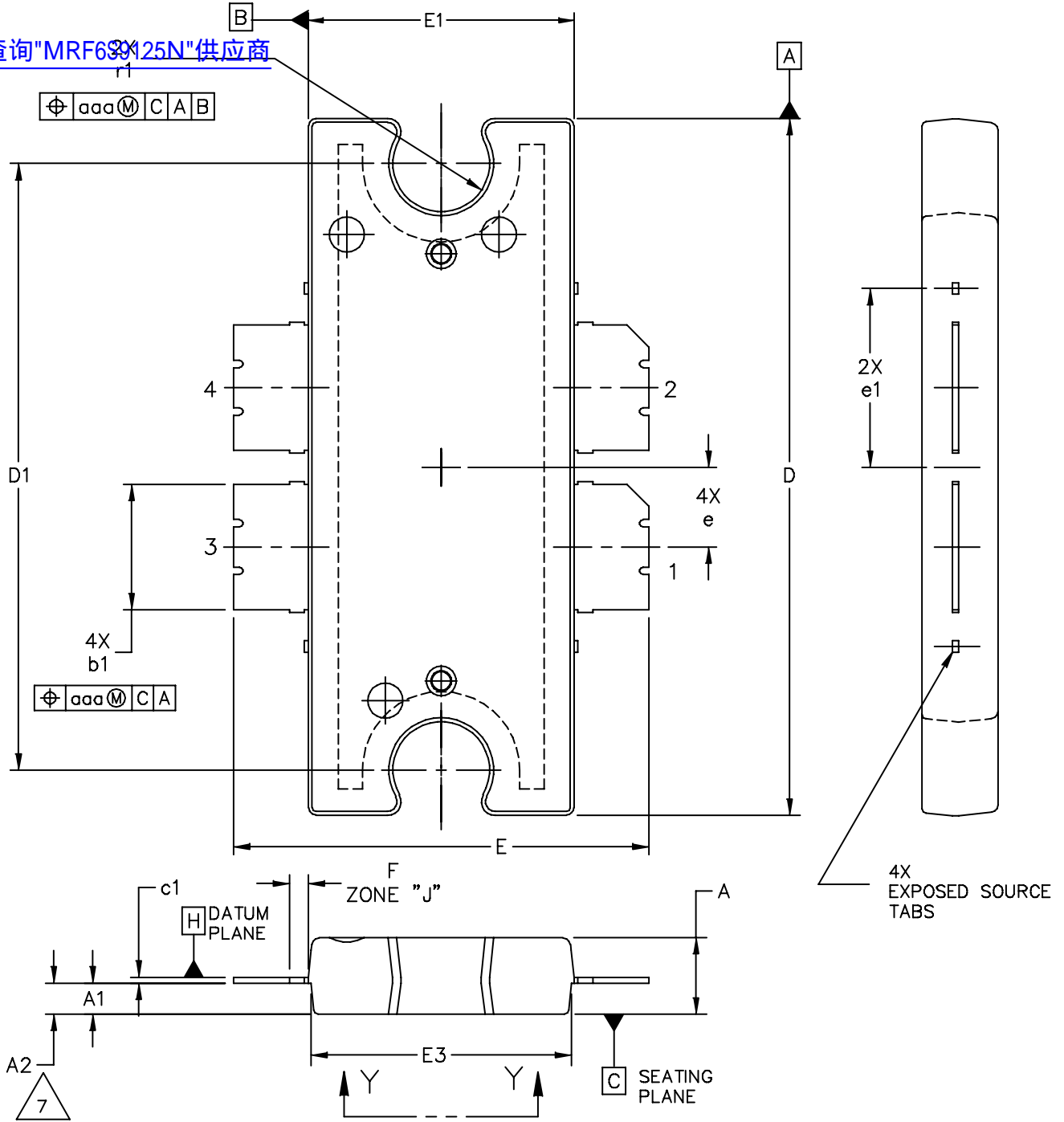

ARCHIVE INFORMATION

ARCHIVE INFORMATION

© FREESCALE SEMICONDUCTOR, INC. ALL RIGHTS RESERVED.		MECHANICAL OUTLINE		PRINT VERSION NOT TO SCALE	
TITLE: TO-272 4 LEAD, WIDE BODY			DOCUMENT NO: 98ASA10575D		REV: E
			CASE NUMBER: 1484-04		31 AUG 2007
			STANDARD: NON-JEDEC		

MRF6S9125NR1 MRF6S9125NBR1

[查询"MRF6S9125N"供应商](#)

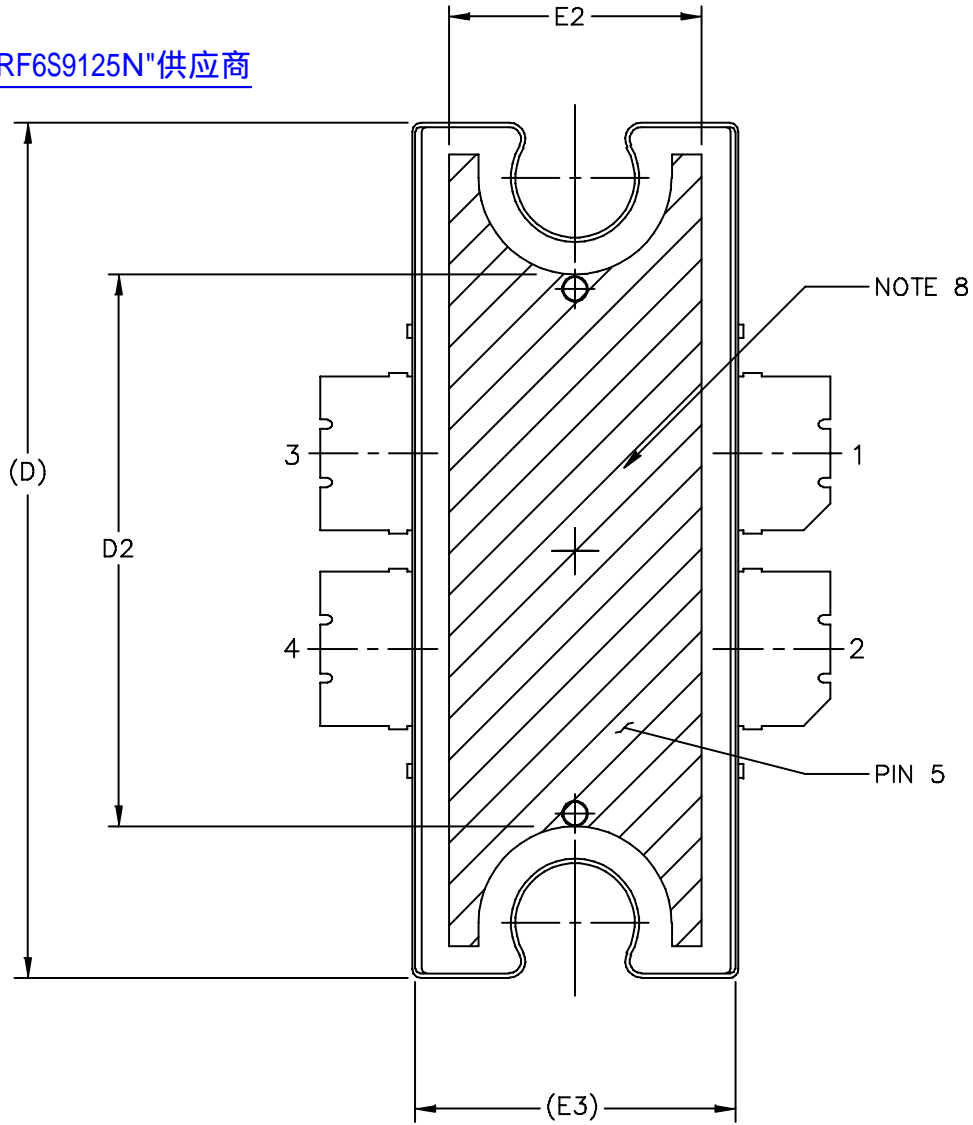

ARCHIVE INFORMATION

ARCHIVE INFORMATION

© FREESCALE SEMICONDUCTOR, INC. ALL RIGHTS RESERVED.	MECHANICAL OUTLINE	PRINT VERSION NOT TO SCALE	
TITLE: TO-272 4 LEAD, WIDE BODY	DOCUMENT NO: 98ASA10575D	REV: E	
	CASE NUMBER: 1484-04	31 AUG 2007	
	STANDARD: NON-JEDEC		

NOTES:

1. CONTROLLING DIMENSION: INCH
[查询"MRF6S9125N"供应商](#)

2. INTERPRET DIMENSIONS AND TOLERANCES PER ASME Y14.5M-1994.
3. DATUM PLANE H IS LOCATED AT THE TOP OF LEAD AND IS COINCIDENT WITH THE LEAD WHERE THE LEAD EXITS THE PLASTIC BODY AT THE TOP OF THE PARTING LINE.
4. DIMENSIONS "D" AND "E1" DO NOT INCLUDE MOLD PROTRUSION. ALLOWABLE PROTRUSION IS .006 PER SIDE. DIMENSIONS "D" AND "E1" DO INCLUDE MOLD MISMATCH AND ARE DETERMINED AT DATUM PLANE H.
5. DIMENSIONS "b1" DOES NOT INCLUDE DAMBAR PROTRUSION. ALLOWABLE DAMBAR PROTRUSION SHALL BE .005 TOTAL IN EXCESS OF THE "b1" DIMENSION AT MAXIMUM MATERIAL CONDITION.
6. DATUM A AND B TO BE DETERMINED AT DATUM PLANE H.
7. DIMENSION A2 APPLIES WITHIN ZONE "J" ONLY.
8. HATCHING REPRESENTS EXPOSED AREA OF THE HEAT SLUG. HATCHED AREA SHOWN IS ON THE SAME PLANE.

STYLE 1:

PIN 1 - DRAIN PIN 2 - DRAIN
 PIN 3 - GATE PIN 4 - GATE
 PIN 5 - SOURCE

DIM	INCH		MILLIMETER		DIM	INCH		MILLIMETER	
	MIN	MAX	MIN	MAX		MIN	MAX	MIN	MAX
A	.100	.104	2.54	2.64	b1	.164	.170	4.17	4.32
A1	.039	.043	0.99	1.09	c1	.007	.011	.18	.28
A2	.040	.042	1.02	1.07	r1	.063	.068	1.60	1.73
D	.928	.932	23.57	23.67	e	.106 BSC		2.69 BSC	
D1	.810 BSC		20.57 BSC		e1	.239 INFO ONLY		6.07 INFO ONLY	
D2	.600	---	15.24	---	aaa	.004		.10	
E	.551	.559	14	14.2					
E1	.353	.357	8.97	9.07					
E2	.270	---	6.86	---					
E3	.346	.350	8.79	8.89					
F	.025 BSC		0.64 BSC						

© FREESCALE SEMICONDUCTOR, INC. ALL RIGHTS RESERVED.		MECHANICAL OUTLINE		PRINT VERSION NOT TO SCALE	
TITLE: TO-272 4 LEAD WIDE BODY			DOCUMENT NO: 98ASA10575D		REV: E
			CASE NUMBER: 1484-04		31 AUG 2007
			STANDARD: NON-JEDEC		

ARCHIVE INFORMATION

ARCHIVE INFORMATION

PRODUCT DOCUMENTATION

[查询"MRF6S9125N"供应商](#)

Refer to the following documents to aid your design process.

Application Notes

- AN1907: Solder Reflow Attach Method for High Power RF Devices in Plastic Packages
- AN1955: Thermal Measurement Methodology of RF Power Amplifiers
- AN3263: Bolt Down Mounting Method for High Power RF Transistors and RFICs in Over-Molded Plastic Packages

Engineering Bulletins

- EB212: Using Data Sheet Impedances for RF LDMOS Devices

REVISION HISTORY

The following table summarizes revisions to this document.

Revision	Date	Description
5	Aug. 2008	<ul style="list-style-type: none"> • Listed replacement part and Device Migration notification reference number, p. 1 • Removed Total Device Dissipation from Max Ratings table as data was redundant (information already provided in Thermal Characteristics table), p. 1 • Added Case Operating Temperature limit to the Maximum Ratings table and set limit to 150°C, p. 1 • Operating Junction Temperature increased from 200°C to 225°C in Maximum Ratings table, related "Continuous use at maximum temperature will affect MTTF" footnote added and changed 200°C to 225°C in Capable Plastic Package bullet, p. 1 • Corrected V_{DS} to V_{DD} in the RF test condition voltage callout for $V_{GS(Q)}$, and added "Measured in Functional Test", On Characteristics table, p. 2 • Removed Forward Transconductance from On Characteristics table as it no longer provided usable information, p. 2 • Updated PCB information to show more specific material details, Figs. 1, 17, Test Circuit Schematic, p. 4, 11 • Updated Part Numbers in Tables 6, 7, Component Designations and Values, to latest RoHS compliant part numbers, p. 4, 11 • Adjusted scale for Fig. 8, Intermodulation Distortion Products versus Tone Spacing, p. 7 • Removed lower voltage tests from Fig. 12, Power Gain versus Output Power, due to fixed tuned fixture limitations, p. 8 • Replaced Fig. 13, MTTF versus Junction Temperature with updated graph. Removed Amps² and listed operating characteristics and location of MTTF calculator for device, p. 8 • Replaced Case Outline 1486-03, Issue C, with 1486-03, Issue D, p. 16-18. Added pin numbers 1 through 4 on Sheet 1. • Replaced Case Outline 1484-04, Issue D, with 1484-04, Issue E, p. 19-21. Added pin numbers 1 through 4 on Sheet 1, replacing Gate and Drain notations with Pin 1 and Pin 2 designations. • Added Product Documentation and Revision History, p. 22

How to Reach Us:

Home Page:

www.freescale.com

Web Support:

<http://www.freescale.com/support>

USA/Europe or Locations Not Listed:

Freescale Semiconductor, Inc.
Technical Information Center, EL516
2100 East Elliot Road
Tempe, Arizona 85284
1-800-521-6274 or +1-480-768-2130
www.freescale.com/support

Europe, Middle East, and Africa:

Freescale Halbleiter Deutschland GmbH
Technical Information Center
Schatzbogen 7
81829 Muenchen, Germany
+44 1296 380 456 (English)
+46 8 52200080 (English)
+49 89 92103 559 (German)
+33 1 69 35 48 48 (French)
www.freescale.com/support

Japan:

Freescale Semiconductor Japan Ltd.
Headquarters
ARCO Tower 15F
1-8-1, Shimo-Meguro, Meguro-ku,
Tokyo 153-0064
Japan
0120 191014 or +81 3 5437 9125
support.japan@freescale.com

Asia/Pacific:

Freescale Semiconductor China Ltd.
Exchange Building 23F
No. 118 Jianguo Road
Chaoyang District
Beijing 100022
China
+86 10 5879 8000
support.asia@freescale.com

For Literature Requests Only:

Freescale Semiconductor Literature Distribution Center
P.O. Box 5405
Denver, Colorado 80217
1-800-441-2447 or +1-303-675-2140
Fax: +1-303-675-2150
LDCForFreescaleSemiconductor@hibbertgroup.com

Information in this document is provided solely to enable system and software implementers to use Freescale Semiconductor products. There are no express or implied copyright licenses granted hereunder to design or fabricate any integrated circuits or integrated circuits based on the information in this document.

Freescale Semiconductor reserves the right to make changes without further notice to any products herein. Freescale Semiconductor makes no warranty, representation or guarantee regarding the suitability of its products for any particular purpose, nor does Freescale Semiconductor assume any liability arising out of the application or use of any product or circuit, and specifically disclaims any and all liability, including without limitation consequential or incidental damages. "Typical" parameters that may be provided in Freescale Semiconductor data sheets and/or specifications can and do vary in different applications and actual performance may vary over time. All operating parameters, including "Typicals", must be validated for each customer application by customer's technical experts. Freescale Semiconductor does not convey any license under its patent rights nor the rights of others. Freescale Semiconductor products are not designed, intended, or authorized for use as components in systems intended for surgical implant into the body, or other applications intended to support or sustain life, or for any other application in which the failure of the Freescale Semiconductor product could create a situation where personal injury or death may occur. Should Buyer purchase or use Freescale Semiconductor products for any such unintended or unauthorized application, Buyer shall indemnify and hold Freescale Semiconductor and its officers, employees, subsidiaries, affiliates, and distributors harmless against all claims, costs, damages, and expenses, and reasonable attorney fees arising out of, directly or indirectly, any claim of personal injury or death associated with such unintended or unauthorized use, even if such claim alleges that Freescale Semiconductor was negligent regarding the design or manufacture of the part.

Freescale™ and the Freescale logo are trademarks of Freescale Semiconductor, Inc. All other product or service names are the property of their respective owners.

© Freescale Semiconductor, Inc. 2006, 2008. All rights reserved.

RoHS-compliant and/or Pb-free versions of Freescale products have the functionality and electrical characteristics of their non-RoHS-compliant and/or non-Pb-free counterparts. For further information, see <http://www.freescale.com> or contact your Freescale sales representative.

For information on Freescale's Environmental Products program, go to <http://www.freescale.com/epp>.

