

# MMBT2222LT1, MMBT2222ALT1

MMBT2222ALT1 is a Preferred Device

## General Purpose Transistors

### NPN Silicon

#### Features

- Pb-Free Package May be Available. The G-Suffix Denotes a Pb-Free Lead Finish

#### MAXIMUM RATINGS

Rating	Symbol	Value	Unit
Collector-Emitter Voltage MMBT2222LT1 MMBT2222ALT1	$V_{CEO}$	30 40	Vdc
Collector-Base Voltage MMBT2222LT1 MMBT2222ALT1	$V_{CBO}$	60 75	Vdc
Emitter-Base Voltage MMBT2222LT1 MMBT2222ALT1	$V_{EBO}$	5.0 6.0	Vdc
Collector Current - Continuous	$I_C$	600	mAdc

#### THERMAL CHARACTERISTICS

Characteristic	Symbol	Max	Unit
Total Device Dissipation FR-5 Board (Note 1) $T_A = 25^\circ\text{C}$ Derate above $25^\circ\text{C}$	$P_D$	225 1.8	mW mW/°C
Thermal Resistance Junction-to-Ambient	$R_{\theta JA}$	556	°C/W
Total Device Dissipation Alumina Substrate (Note 2) $T_A = 25^\circ\text{C}$ Derate above $25^\circ\text{C}$	$P_D$	300 2.4	mW mW/°C
Thermal Resistance Junction-to-Ambient	$R_{\theta JA}$	417	°C/W
Junction and Storage Temperature Range	$T_J, T_{stg}$	-55 to +150	°C

Maximum ratings are those values beyond which device damage can occur. Maximum ratings applied to the device are individual stress limit values (not normal operating conditions) and are not valid simultaneously. If these limits are exceeded, device functional operation is not implied, damage may occur and reliability may be affected.

- FR-5 =  $1.0 \times 0.75 \times 0.062$  in.
- Alumina =  $0.4 \times 0.3 \times 0.024$  in. 99.5% alumina.



ON Semiconductor®

<http://onsemi.com>

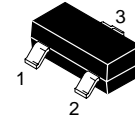
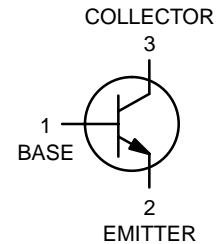

SOT-23  
CASE 318  
Style 6

#### MARKING DIAGRAM

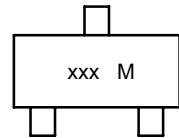

xxx = Specific Device Code  
(M1B = MMBT2222LT1,  
1P = MMBT2222ALT1)  
M = Date Code

#### ORDERING INFORMATION

Device	Package	Shipping†
MMBT2222LT1	SOT-23	3000/Tape & Reel
MMBT2222LT1G	SOT-23 (Pb-Free)	3000/Tape & Reel
MMBT2222ALT1	SOT-23	3000/Tape & Reel
MMBT2222ALT1G	SOT-23 (Pb-Free)	3000/Tape & Reel
MMBT2222LT3	SOT-23	10,000/Tape & Reel
MMBT2222ALT3	SOT-23	10,000/Tape & Reel
MMBT2222ALT3G	SOT-23 (Pb-Free)	10,000/Tape & Reel

†For information on tape and reel specifications, including part orientation and tape sizes, please refer to our Tape and Reel Packaging Specifications Brochure, BRD8011/D.

Preferred devices are recommended choices for future use and best overall value.

# MMBT2222LT1, MMBT2222ALT1

## ELECTRICAL CHARACTERISTICS (T<sub>A</sub> = 25°C unless otherwise noted)

Characteristic	Symbol	Min	Max	Unit	
<b>OFF CHARACTERISTICS</b>					
Collector–Emitter Breakdown Voltage (I <sub>C</sub> = 10 mAdc, I <sub>B</sub> = 0)	MMBT2222 MMBT2222A	V <sub>(BR)CEO</sub>	30 40	– –	Vdc
Collector–Base Breakdown Voltage (I <sub>C</sub> = 10 μAdc, I <sub>E</sub> = 0)	MMBT2222 MMBT2222A	V <sub>(BR)CBO</sub>	60 75	– –	Vdc
Emitter–Base Breakdown Voltage (I <sub>E</sub> = 10 μAdc, I <sub>C</sub> = 0)	MMBT2222 MMBT2222A	V <sub>(BR)EBO</sub>	5.0 6.0	– –	Vdc
Collector Cutoff Current (V <sub>CE</sub> = 60 Vdc, V <sub>EB(off)</sub> = 3.0 Vdc)	MMBT2222A	I <sub>CEX</sub>	–	10	nAdc
Collector Cutoff Current (V <sub>CB</sub> = 50 Vdc, I <sub>E</sub> = 0)	MMBT2222 MMBT2222A	I <sub>CBO</sub>	–	0.01 0.01	μAdc
(V <sub>CB</sub> = 60 Vdc, I <sub>E</sub> = 0)	MMBT2222		–	10	
(V <sub>CB</sub> = 50 Vdc, I <sub>E</sub> = 0, T <sub>A</sub> = 125°C)	MMBT2222		–	10	
(V <sub>CB</sub> = 60 Vdc, I <sub>E</sub> = 0, T <sub>A</sub> = 125°C)	MMBT2222A		–	10	
Emitter Cutoff Current (V <sub>EB</sub> = 3.0 Vdc, I <sub>C</sub> = 0)	MMBT2222A	I <sub>EBO</sub>	–	100	nAdc
Base Cutoff Current (V <sub>CE</sub> = 60 Vdc, V <sub>EB(off)</sub> = 3.0 Vdc)	MMBT2222A	I <sub>BL</sub>	–	20	nAdc

## ON CHARACTERISTICS

DC Current Gain (I <sub>C</sub> = 0.1 mAdc, V <sub>CE</sub> = 10 Vdc) (I <sub>C</sub> = 1.0 mAdc, V <sub>CE</sub> = 10 Vdc) (I <sub>C</sub> = 10 mAdc, V <sub>CE</sub> = 10 Vdc) (I <sub>C</sub> = 10 mAdc, V <sub>CE</sub> = 10 Vdc, T <sub>A</sub> = –55°C) (I <sub>C</sub> = 150 mAdc, V <sub>CE</sub> = 10 Vdc) (Note 3) (I <sub>C</sub> = 150 mAdc, V <sub>CE</sub> = 1.0 Vdc) (Note 3) (I <sub>C</sub> = 500 mAdc, V <sub>CE</sub> = 10 Vdc) (Note 3)	MMBT2222A only      MMBT2222 MMBT2222A	h <sub>FE</sub>	35 50 75 35 100 50 30 40	– – – – 300 – – –	–
Collector–Emitter Saturation Voltage (Note 3) (I <sub>C</sub> = 150 mAdc, I <sub>B</sub> = 15 mAdc)	MMBT2222 MMBT2222A	V <sub>CE(sat)</sub>	– –	0.4 0.3	Vdc
(I <sub>C</sub> = 500 mAdc, I <sub>B</sub> = 50 mAdc)	MMBT2222 MMBT2222A		– –	1.6 1.0	
Base–Emitter Saturation Voltage (Note 3) (I <sub>C</sub> = 150 mAdc, I <sub>B</sub> = 15 mAdc)	MMBT2222 MMBT2222A	V <sub>BE(sat)</sub>	– 0.6	1.3 1.2	Vdc
(I <sub>C</sub> = 500 mAdc, I <sub>B</sub> = 50 mAdc)	MMBT2222 MMBT2222A		– –	2.6 2.0	

## SMALL–SIGNAL CHARACTERISTICS

Current–Gain–Bandwidth Product (Note 4) (I <sub>C</sub> = 20 mAdc, V <sub>CE</sub> = 20 Vdc, f = 100 MHz)	MMBT2222 MMBT2222A	f <sub>T</sub>	250 300	– –	MHz
Output Capacitance (V <sub>CB</sub> = 10 Vdc, I <sub>E</sub> = 0, f = 1.0 MHz)		C <sub>obo</sub>	–	8.0	pF
Input Capacitance (V <sub>EB</sub> = 0.5 Vdc, I <sub>C</sub> = 0, f = 1.0 MHz)	MMBT2222 MMBT2222A	C <sub>ibo</sub>	– –	30 25	pF
Input Impedance (I <sub>C</sub> = 1.0 mAdc, V <sub>CE</sub> = 10 Vdc, f = 1.0 kHz) (I <sub>C</sub> = 10 mAdc, V <sub>CE</sub> = 10 Vdc, f = 1.0 kHz)	MMBT2222A MMBT2222A	h <sub>ie</sub>	2.0 0.25	8.0 1.25	kΩ
Voltage Feedback Ratio (I <sub>C</sub> = 1.0 mAdc, V <sub>CE</sub> = 10 Vdc, f = 1.0 kHz) (I <sub>C</sub> = 10 mAdc, V <sub>CE</sub> = 10 Vdc, f = 1.0 kHz)	MMBT2222A MMBT2222A	h <sub>re</sub>	– –	8.0 4.0	X 10 <sup>–4</sup>
Small–Signal Current Gain (I <sub>C</sub> = 1.0 mAdc, V <sub>CE</sub> = 10 Vdc, f = 1.0 kHz) (I <sub>C</sub> = 10 mAdc, V <sub>CE</sub> = 10 Vdc, f = 1.0 kHz)	MMBT2222A MMBT2222A	h <sub>fe</sub>	50 75	300 375	–

3. Pulse Test: Pulse Width ≤ 300 μs, Duty Cycle ≤ 2.0%.

4. f<sub>T</sub> is defined as the frequency at which |h<sub>re</sub>| extrapolates to unity.

# MMBT2222LT1, MMBT2222ALT1

## ELECTRICAL CHARACTERISTICS (T<sub>A</sub> = 25°C unless otherwise noted)

Characteristic	Symbol	Min	Max	Unit
<b>SMALL-SIGNAL CHARACTERISTICS</b>				
Output Admittance (I <sub>C</sub> = 1.0 mA <sub>dc</sub> , V <sub>CE</sub> = 10 V <sub>dc</sub> , f = 1.0 kHz) (I <sub>C</sub> = 10 mA <sub>dc</sub> , V <sub>CE</sub> = 10 V <sub>dc</sub> , f = 1.0 kHz)	h <sub>oe</sub>	5.0 25	35 200	μmhos
Collector Base Time Constant (I <sub>E</sub> = 20 mA <sub>dc</sub> , V <sub>CB</sub> = 20 V <sub>dc</sub> , f = 31.8 MHz)	r <sub>b</sub> , C <sub>c</sub>	–	150	ps
Noise Figure (I <sub>C</sub> = 100 μA <sub>dc</sub> , V <sub>CE</sub> = 10 V <sub>dc</sub> , R <sub>S</sub> = 1.0 kΩ, f = 1.0 kHz)	NF	–	4.0	dB

### SWITCHING CHARACTERISTICS (MMBT2222A only)

Delay Time	(V <sub>CC</sub> = 30 V <sub>dc</sub> , V <sub>BE(off)</sub> = –0.5 V <sub>dc</sub> , I <sub>C</sub> = 150 mA <sub>dc</sub> , I <sub>B1</sub> = 15 mA <sub>dc</sub> )	t <sub>d</sub>	–	10	ns
Rise Time		t <sub>r</sub>	–	25	
Storage Time	(V <sub>CC</sub> = 30 V <sub>dc</sub> , I <sub>C</sub> = 150 mA <sub>dc</sub> , I <sub>B1</sub> = I <sub>B2</sub> = 15 mA <sub>dc</sub> )	t <sub>s</sub>	–	225	ns
Fall Time		t <sub>f</sub>	–	60	

- Pulse Test: Pulse Width ≤ 300 μs, Duty Cycle ≤ 2.0%.
- t<sub>f</sub> is defined as the frequency at which |h<sub>fe</sub>| extrapolates to unity.

### SWITCHING TIME EQUIVALENT TEST CIRCUITS

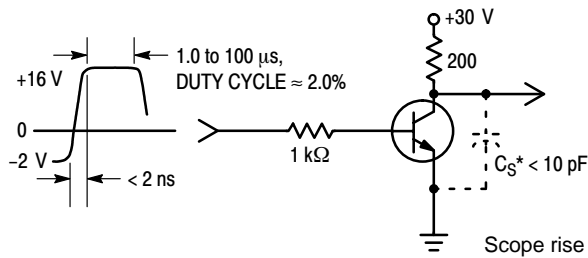

Figure 1. Turn-On Time

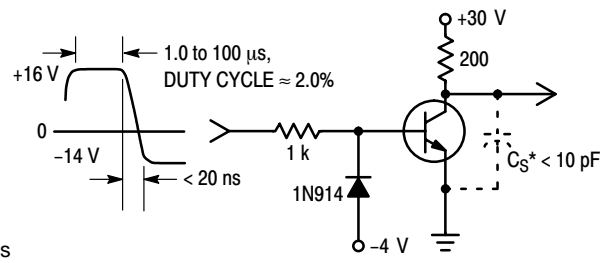
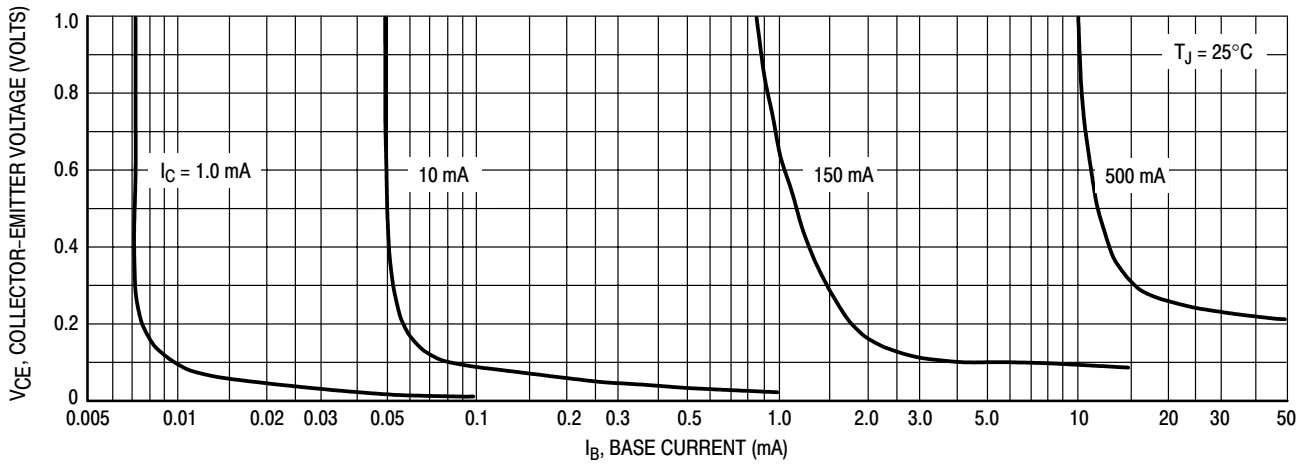
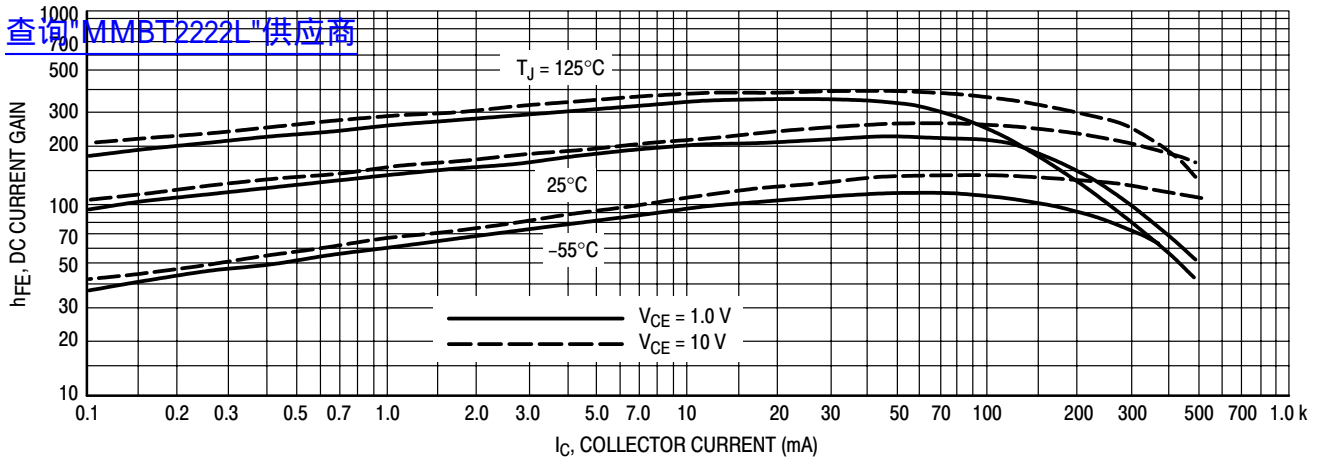
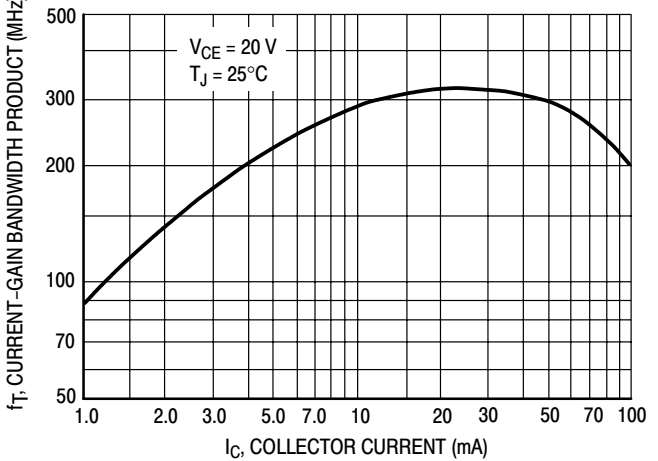
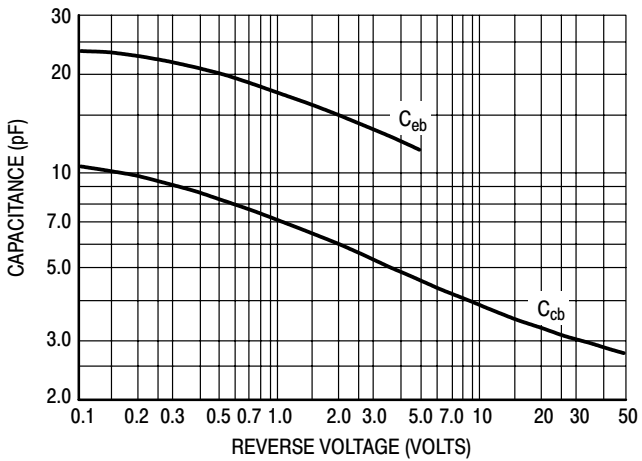
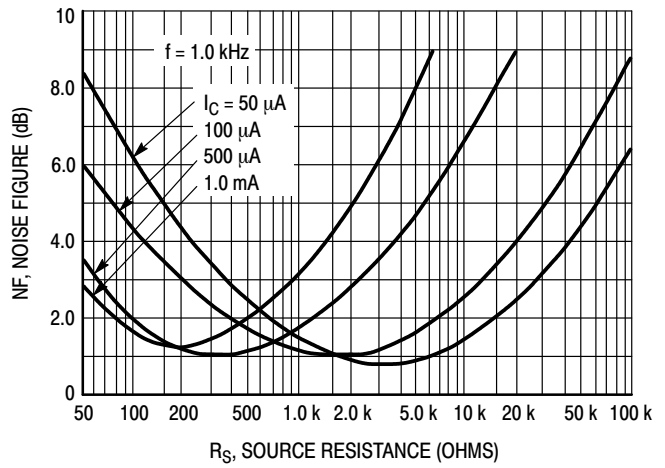
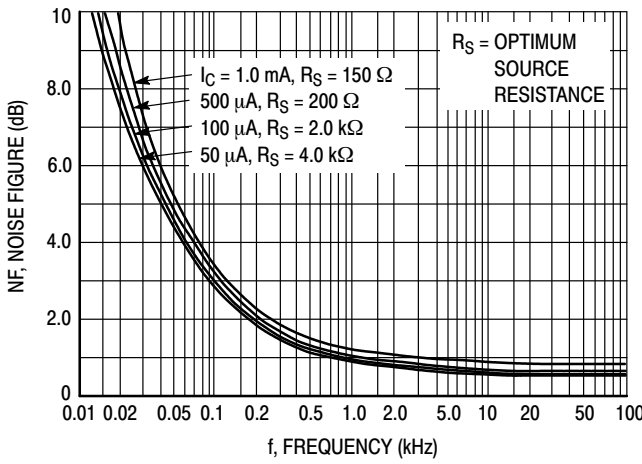
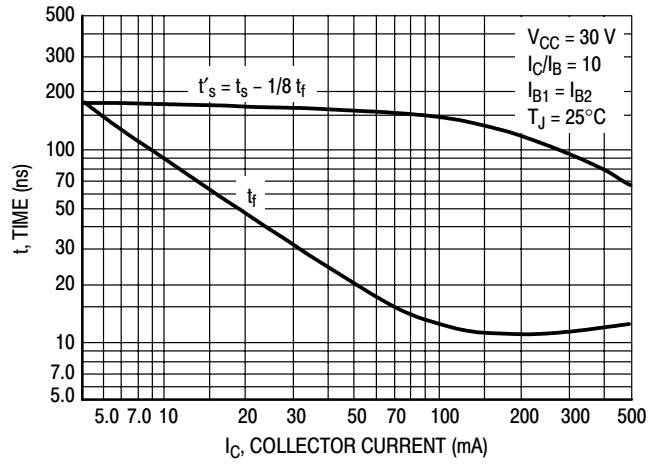
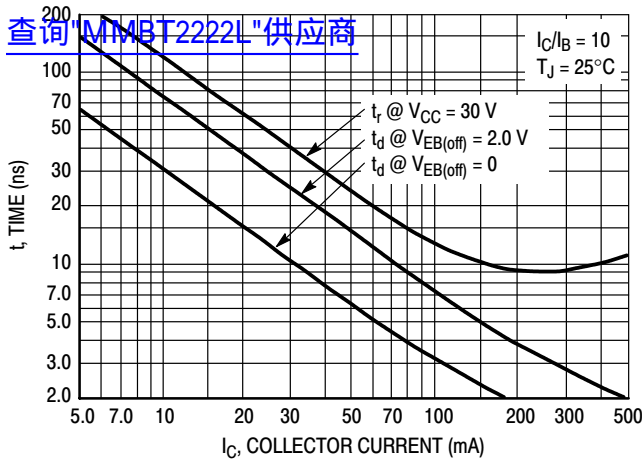

Figure 2. Turn-Off Time

# MMBT2222LT1, MMBT2222ALT1



# MMBT2222LT1, MMBT2222ALT1



# MMBT2222LT1, MMBT2222ALT1

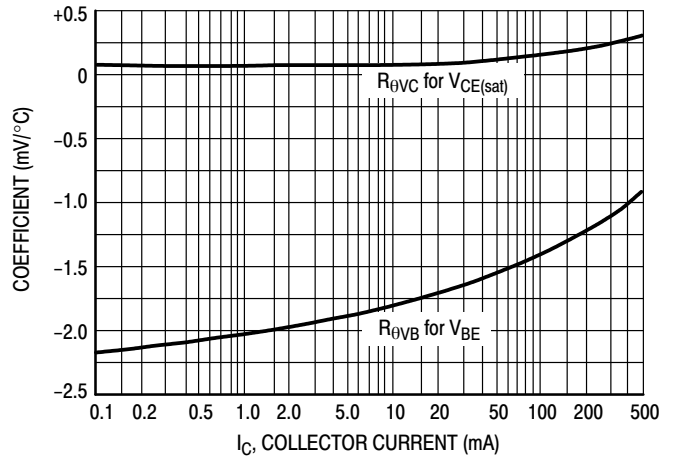
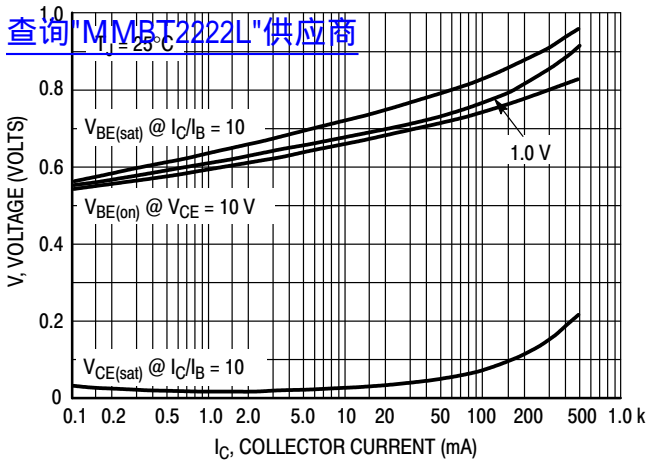

# MMBT2222LT1, MMBT2222ALT1

[查询"MMBT2222L"供应商](#)

## PACKAGE DIMENSIONS

SOT-23 (TO-236AB)  
CASE 318-08  
ISSUE AH

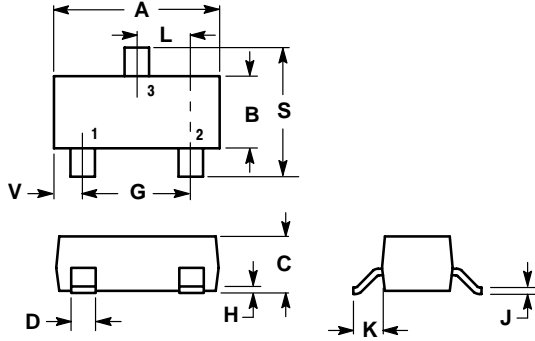

NOTES:

1. DIMENSIONING AND TOLERANCING PER ANSI Y14.5M, 1982.
2. CONTROLLING DIMENSION: INCH.
3. MAXIMUM LEAD THICKNESS INCLUDES LEAD FINISH THICKNESS. MINIMUM LEAD THICKNESS IS THE MINIMUM THICKNESS OF BASE MATERIAL.
4. 318-03 AND -07 OBSOLETE, NEW STANDARD 318-08.

DIM	INCHES		MILLIMETERS	
	MIN	MAX	MIN	MAX
A	0.1102	0.1197	2.80	3.04
B	0.0472	0.0551	1.20	1.40
C	0.0350	0.0440	0.89	1.11
D	0.0150	0.0200	0.37	0.50
G	0.0701	0.0807	1.78	2.04
H	0.0005	0.0040	0.013	0.100
J	0.0034	0.0070	0.085	0.177
K	0.0140	0.0285	0.35	0.69
L	0.0350	0.0401	0.89	1.02
S	0.0830	0.1039	2.10	2.64
V	0.0177	0.0236	0.45	0.60

STYLE 6:

1. BASE
2. EMITTER
3. COLLECTOR

## SOLDERING FOOTPRINT\*

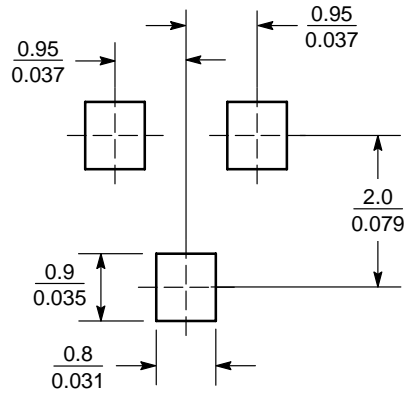

\*For additional information on our Pb-Free strategy and soldering details, please download the ON Semiconductor Soldering and Mounting Techniques Reference Manual, SOLDERRM/D.

# MMBT2222LT1, MMBT2222ALT1

[查询"MMBT2222L"供应商](#)

**ON Semiconductor** and  are registered trademarks of Semiconductor Components Industries, LLC (SCILLC). SCILLC reserves the right to make changes without further notice to any products herein. SCILLC makes no warranty, representation or guarantee regarding the suitability of its products for any particular purpose, nor does SCILLC assume any liability arising out of the application or use of any product or circuit, and specifically disclaims any and all liability, including without limitation special, consequential or incidental damages. "Typical" parameters which may be provided in SCILLC data sheets and/or specifications can and do vary in different applications and actual performance may vary over time. All operating parameters, including "Typicals" must be validated for each customer application by customer's technical experts. SCILLC does not convey any license under its patent rights nor the rights of others. SCILLC products are not designed, intended, or authorized for use as components in systems intended for surgical implant into the body, or other applications intended to support or sustain life, or for any other application in which the failure of the SCILLC product could create a situation where personal injury or death may occur. Should Buyer purchase or use SCILLC products for any such unintended or unauthorized application, Buyer shall indemnify and hold SCILLC and its officers, employees, subsidiaries, affiliates, and distributors harmless against all claims, costs, damages, and expenses, and reasonable attorney fees arising out of, directly or indirectly, any claim of personal injury or death associated with such unintended or unauthorized use, even if such claim alleges that SCILLC was negligent regarding the design or manufacture of the part. SCILLC is an Equal Opportunity/Affirmative Action Employer. This literature is subject to all applicable copyright laws and is not for resale in any manner.

## PUBLICATION ORDERING INFORMATION

### LITERATURE FULFILLMENT:

Literature Distribution Center for ON Semiconductor  
P.O. Box 61312, Phoenix, Arizona 85082-1312 USA  
**Phone:** 480-829-7710 or 800-344-3860 Toll Free USA/Canada  
**Fax:** 480-829-7709 or 800-344-3867 Toll Free USA/Canada  
**Email:** [orderlit@onsemi.com](mailto:orderlit@onsemi.com)

**N. American Technical Support:** 800-282-9855 Toll Free  
USA/Canada

**Japan:** ON Semiconductor, Japan Customer Focus Center  
2-9-1 Kamimeguro, Meguro-ku, Tokyo, Japan 153-0051  
**Phone:** 81-3-5773-3850

**ON Semiconductor Website:** <http://onsemi.com>

**Order Literature:** <http://www.onsemi.com/litorder>

For additional information, please contact your  
local Sales Representative.

**MMBT2222LT1/D**