

Distinctive Characteristics

Power and logic level capabilities available to suit varying applications.

Bushing and snap-in mount versions available; snap-in models offer many style and color choices to enhance front panel appearance.

Light touch actuation.

High torque bushing prevents rotation and separation from metal frame during installation.

Stainless steel frame resists corrosion.

Case of heat resistant resin meets UL 94V-0 flammability rating.

Higher insulating barriers protect against crossover in double pole devices.

1,500V dielectric strength between contacts and case is accomplished by clinching the frame away from the terminals.

Epoxy sealed terminals prevent entry of solder flux and other contaminants.

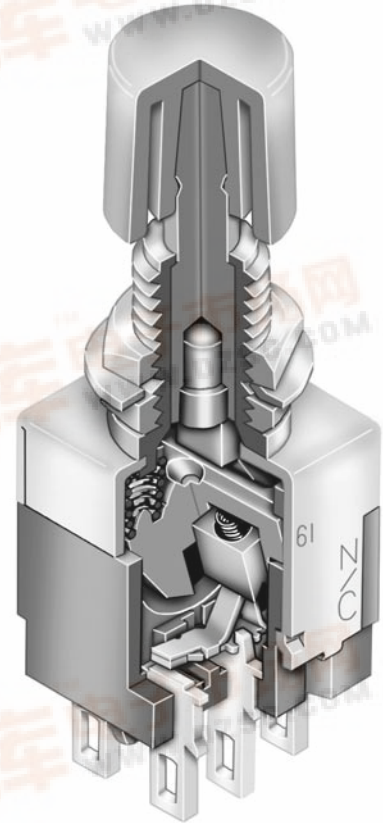

Actual Size

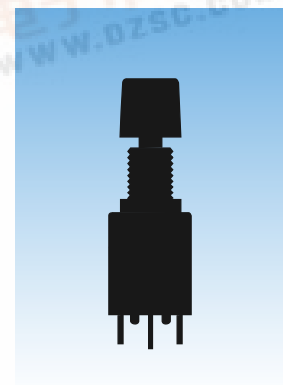

General Specifications

Electrical Capacity (Resistive Load)

Power Level (No code or P):	3A @ 125V AC for silver contacts
Logic Level (code G or PG):	0.4VA maximum @ 28V AC/DC maximum for gold contacts (Applicable Range 0.1mA ~ 0.1A @ 20mV ~ 28V)
	Note: Find additional explanation of operating range in Supplement section.

Other Ratings

Contact Resistance:	10 milliohms maximum for silver; 20 milliohms maximum for gold
Insulation Resistance:	1,000 megohms minimum @ 500V DC
Dielectric Strength:	1,000V AC minimum between contacts for 1 minute minimum; 1,500V AC minimum between contacts and case for 1 minute minimum
Mechanical Life:	100,000 operations minimum
Electrical Life:	25,000 operations minimum for silver; 50,000 operations minimum for gold
Nominal Operating Force:	Single Pole: 2.35N for Momentary and 2.65N for Alternate Action Double Pole: 2.94N for Momentary and 3.63N for Alternate Action
Travel:	Momentary: Pretravel .047" (1.2mm); Overtravel .016" (0.4mm); Total Travel .063" (1.6mm) Alternate: Pretravel .071" (1.8mm); Overtravel .016" (0.4mm); Total Travel .087" (2.2mm)

Materials & Finishes

Plunger:	Brass with chrome plating for Momentary; brass with nickel plating for Alternate
Bushing:	Brass with nickel plating
Frame:	Stainless steel
Case:	Melamine phenolic resin (UL94V-0)
Movable Contacts:	Copper with silver or gold plating
Stationary Contacts:	Silver with silver or gold plating
Terminals:	Copper with silver or gold plating



Environmental Data

Operating Temp Range:	-10°C through +70°C (+14°F through +158°F)
Humidity:	90 ~ 95% humidity for 96 hours @ 40°C (104°F)
Vibration:	10 ~ 55Hz with peak-to-peak amplitude of 1.5mm traversing the frequency range and returning in 1 minute; 3 right angled directions for 2 hours
Shock:	50G (490m/s ²) acceleration (tested in 6 right angled directions, with 5 shocks in each direction)

Installation

Mounting Torque:	1.47Nm (13.0 lb•in) for double nut; 0.68Nm (6.0 lb•in) for single nut
Cap Installation Force:	78.5N (17.65 lbf) maximum downward force on actuator
Soldering Time & Temp:	Wave Solder (Straight PC): See Profile B in Supplement section. Manual Soldering: See Profile B in Supplement section.
Cleaning:	These devices are not process sealed. Hand clean locally using alcohol based solution.

Standards & Certifications

Flammability Standards:	UL94V-0 case
 UL Recognized:	All single and double pole models recognized at 3A @ 125V AC; UL File No. WOYR2.E44145; add "/U" to end of part number to order UL mark on switch.
 C-UL Recognized:	All single and double pole models recognized at 3A @ 125V AC; UL File No. WOYR8.E44145; add "/C-UL" to end of part number to order C-UL mark on switch.
 CSA Certified:	Single pole solder lug and PC models certified at 3A @ 125V AC; double pole PC models certified at 3A @ 125V AC; CSA File No. 023535-0-000; add "/C" to end of part number to order CSA mark on switch.

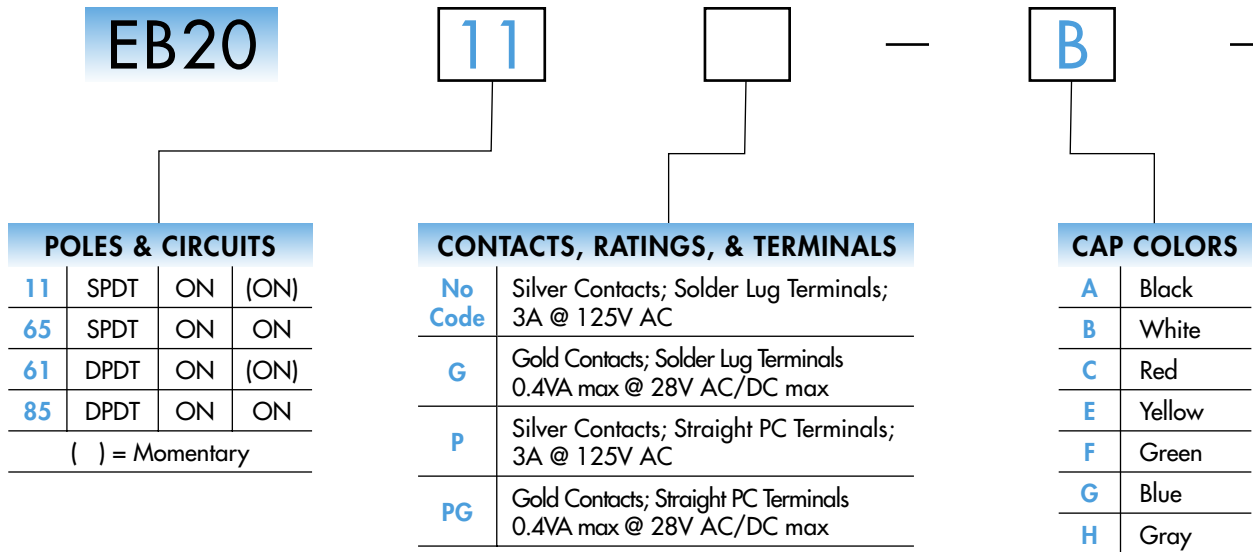

CAP EXTENSIONS & BEZEL TYPES				
Low Rise		High Rise		Description
Momentary	Alternate	Momentary	Alternate	
J20	J30	J40	J50	Without Bezel
J21	J31	J41	J51	Bezel without LED
J22	J32	J42	J52	Bezel with 1 Round LED
J23	J33	J43	J53	Bezel with 2 Round LEDs
J24	J34	J44	J54	Bezel with 2 Rectangular LEDs

IMPORTANT:



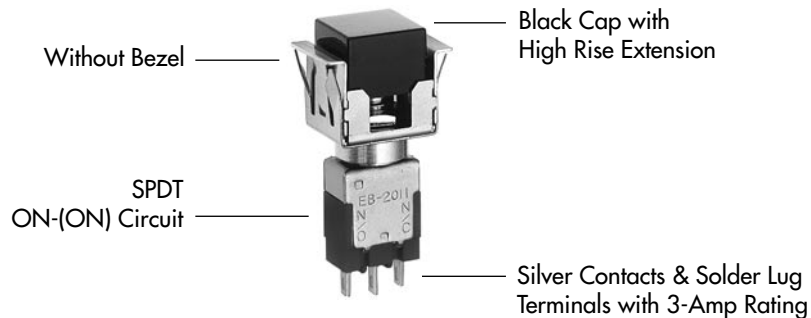

Switches are supplied without UL, C-UL & CSA markings unless specified. Specific models & ratings noted on General Specifications page.

DESCRIPTION FOR TYPICAL ORDERING EXAMPLE WITHOUT BEZEL

EB2011-A-J40

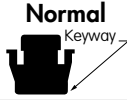

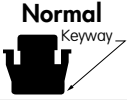
POLES & CIRCUITS

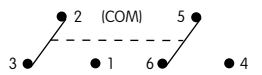
Pole	Model	Plunger Position () = Momentary		Connected Terminals		Throw & Switch Schematics
		Normal 	Down 	Normal 	Down 	
SP	EB2011 EB2065	ON ON	(ON) ON	2-3	2-1	SPDT 
DP	EB2061 EB2085	ON ON	(ON) ON	2-3 5-6	2-1 5-4	DPDT 

CONTACT MATERIALS, RATINGS, & TERMINALS



**Solder Lug
Silver Contacts**

Power Level

3A @ 125V AC



**Solder Lug
Gold Contacts**

Logic Level

0.4VA maximum @ 28V AC/DC maximum

Complete explanation of operating range in Supplement section.

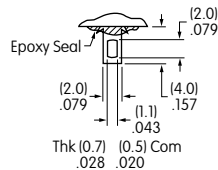

**Straight PC
Silver Contacts**

Power Level

3A @ 125V AC



**Straight PC
Gold Contacts**

Logic Level

0.4VA maximum @ 28V AC/DC maximum

Complete explanation of operating range in Supplement section.

PCB Footprints

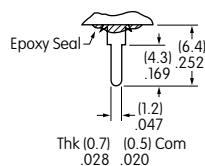

Single Pole

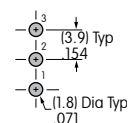

Double Pole

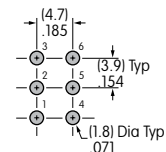

CAP COLORS

Factory Assembled on the Switch:

Square snap-on cap AT465, snap-in mounter AT529, and optional bezels which follow.



Black



White



Red



Yellow



Green



Blue



Gray

CAP EXTENSIONS & BEZEL TYPES

Cap Extension without Bezel

J20

Low Rise Momentary

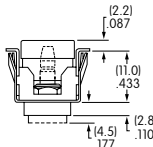

J30

Low Rise Alternate

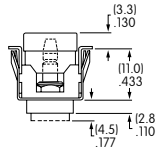

J40

High Rise Momentary

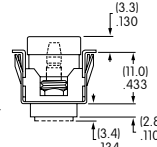

J50

High Rise Alternate

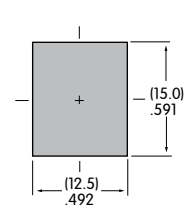
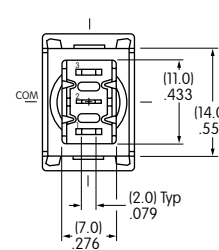
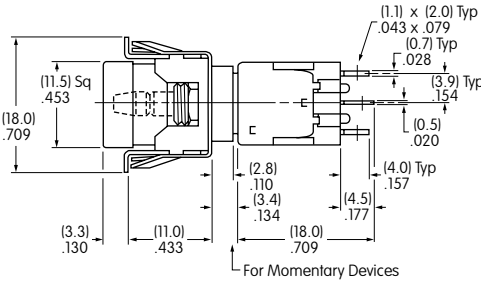
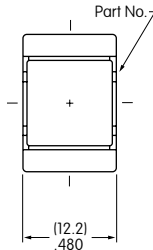
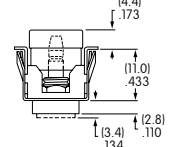

Maximum Panel Thickness
.039" ~ .157" (1.0mm ~ 4.0mm)
Cutout applies to SP & DP

EB2011-A-J40

High Rise

Single Pole

Cap Extension with Bezel

J21

Low Rise Momentary

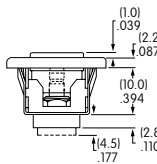

J31

Low Rise Alternate

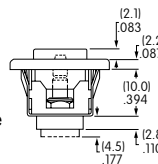

J41

High Rise Momentary

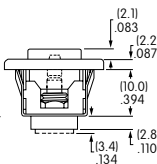

J51

High Rise Alternate

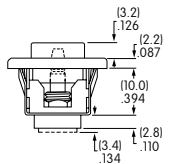

AT207 Bezel without LED



Yellow



Black



Green



White



Blue



Red



Gray

Material:
Polycarbonate

Finish:
Glossy

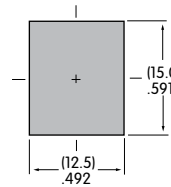
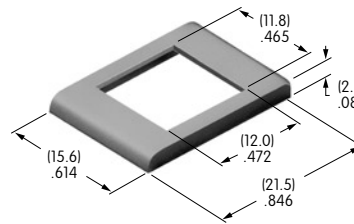

Maximum Panel Thickness
.039" ~ .126" (1.0mm ~ 3.2mm)
Cutout applies to SP & DP

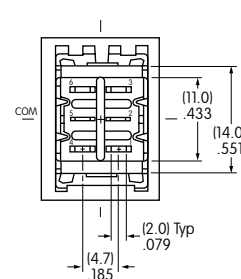
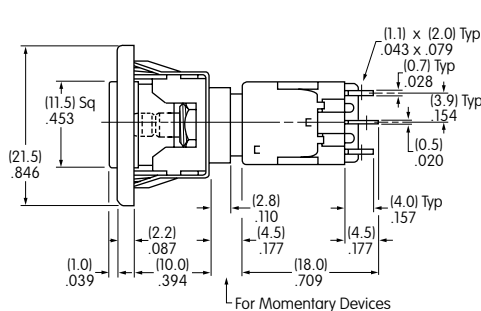
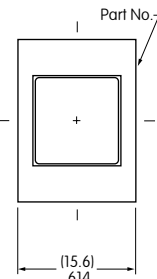

EB2061-B-J21A

Low Rise

Double Pole

CAP EXTENSIONS & BEZEL TYPES

Cap Extension with Bezel

J22

Low Rise Momentary

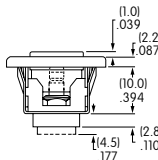

J32

Low Rise Alternate

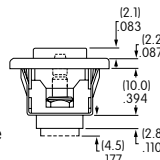

J42

High Rise Momentary

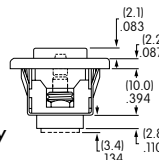

J52

High Rise Alternate

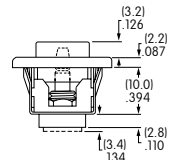

AT208 Bezel with 1 Round LED (AT070 LED)

A

Black

Material: Polycarbonate
Finish: Glossy

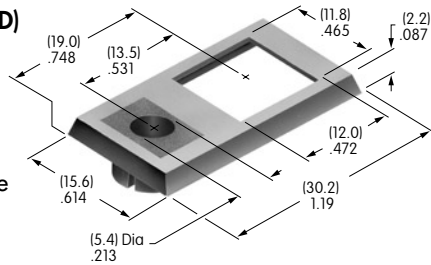

Maximum Panel Thickness
.039" ~ .126"
(1.0mm ~ 3.2mm)
Cutout applies to SP & DP

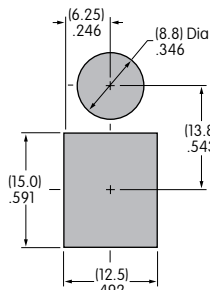

LED colors and specifications on next to last page of this EB section.

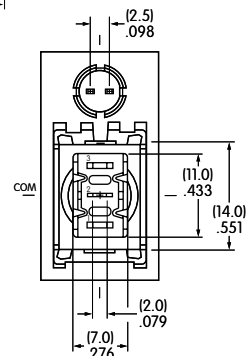
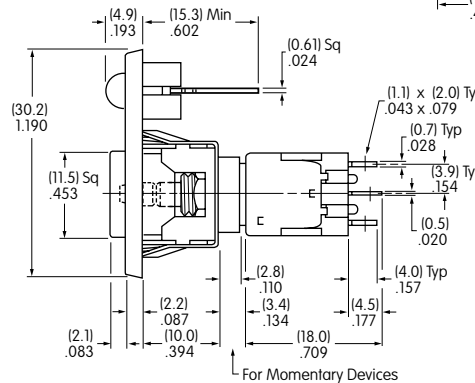
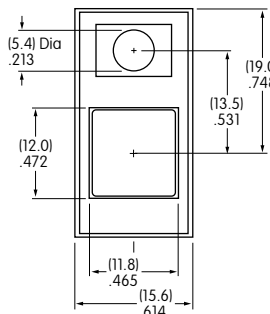

EB2011-B-J42AC

High Rise

Single Pole

Cap Extension with Bezel

J23

Low Rise Momentary

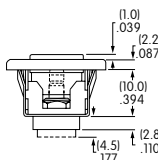

J33

Low Rise Alternate

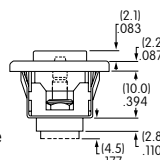

J43

High Rise Momentary

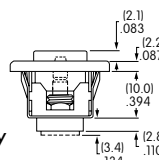

J53

High Rise Alternate

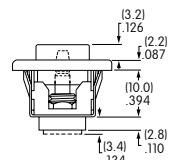

AT212 Bezel with 2 Round LEDs (AT617 LEDs)

A

Black

Material: Polycarbonate
Finish: Glossy

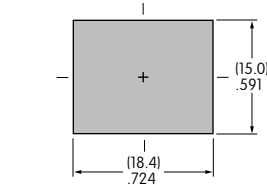
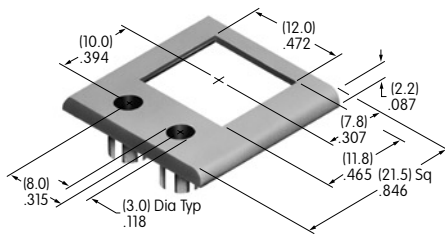

Maximum Panel Thickness
.039" ~ .126" (1.0mm ~ 3.2mm)
Cutout applies to SP & DP

LED colors and specifications on next to last page of this EB section.

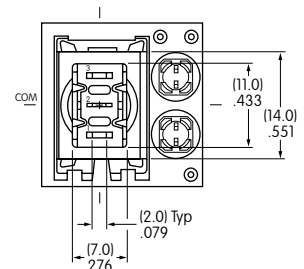
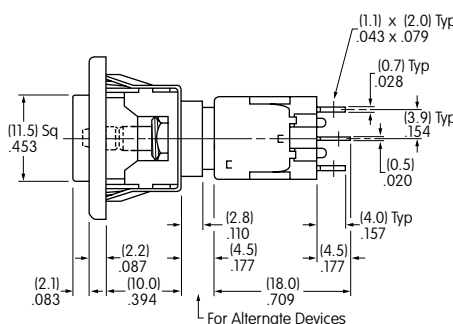
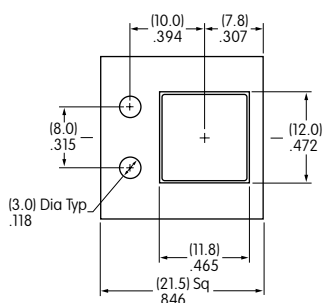

EB2065-B-J33ACF

Low Rise

Single Pole

CAP EXTENSIONS & BEZEL TYPES

Cap Extension with Bezel

J24

Low Rise Momentary

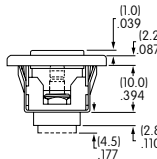

J34

Low Rise Alternate

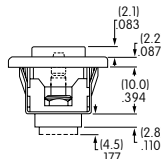

J44

High Rise Momentary

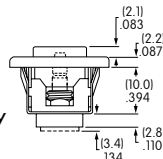

J54

High Rise Alternate

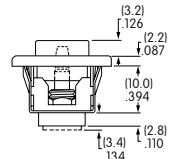

AT213 Bezel with 2 Rectangular LEDs (AT618 LEDs)

A

Black

Material: Polycarbonate
Finish: Glossy

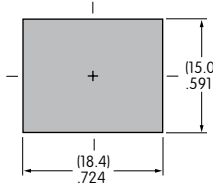
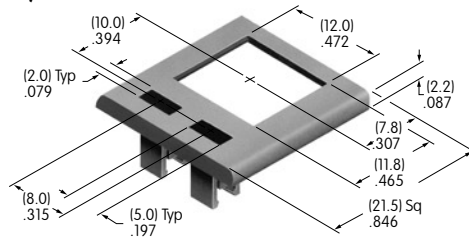

LED colors and specifications on next page of this EB section.

Maximum Panel Thickness
.039" ~ .126" (1.0mm ~ 3.2mm)
Cutout applies to SP & DP

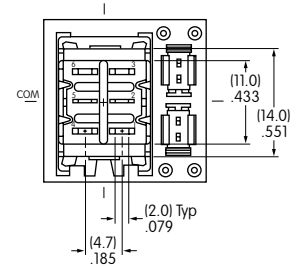
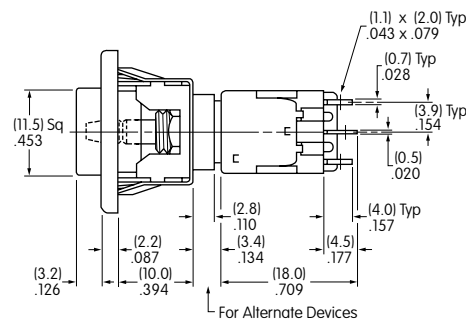
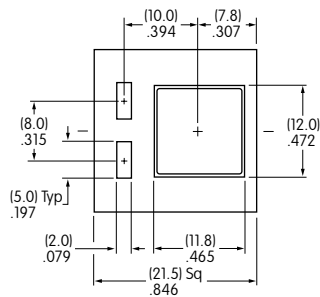

EB2085-B-J54ACF

High Rise

Double Pole

LED COLORS & SPECIFICATIONS

Bezel Orientation on Switch

AT070 LED
For Bezel AT208
with 1 LED

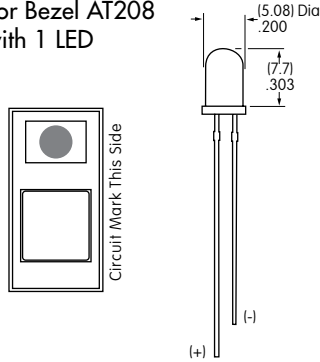

AT617 LED
For Bezel AT212
with 2 Round LEDs

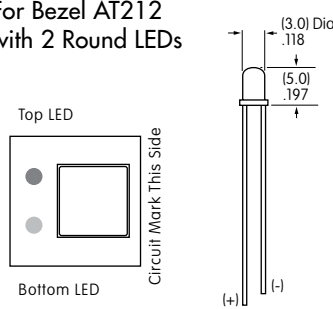

AT618 LED
For Bezel AT213
with 2 Rectangular LEDs

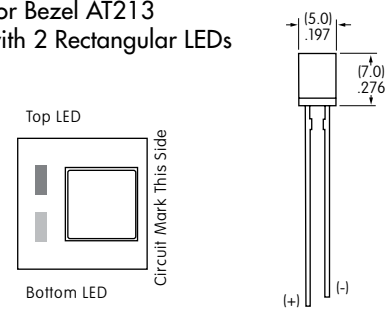

Note: Lead lengths may differ from manufacturing lot to lot. The longer lead is the anode (+).

	Color	AT070		AT617			AT618		
		C	F	C	E	F	C	E	F
		Red	Green	Red	Yellow	Green	Red	Yellow	Green
Forward Peak Current	I_{FM}	25mA	30mA	30mA	30mA	30mA	10mA	30mA	30mA
Continuous Forward Current	I_F	20mA	20mA	24mA	24mA	24mA	8mA	24mA	24mA
Forward Voltage	V_F	2.8V	2.1V	2.0V	2.0V	2.1V	1.9V	2.0V	2.1V
Reverse Peak Voltage	V_{RM}	4V	5V	5V	5V	5V	5V	5V	5V
Current Reduction Rate Above 25°C	ΔI_F	0.33 mA/°C	0.40 mA/°C	0.40 mA/°C	0.40 mA/°C	0.40 mA/°C	0.13 mA/°C	0.40 mA/°C	0.40 mA/°C
Ambient Temperature Range (when used with a bezel)		-10° ~ +70°C		-15° ~ +70°C			-15° ~ +70°C		

The electrical specifications shown are determined at a basic temperature of 25°C.
LED circuit is independent of switch operation. LED is colored in OFF state.

If the source voltage is greater than the rated voltage of the LED, a ballast resistor must be connected in series with the lamp.
The ballast resistor calculation and more lamp detail are shown in the Supplement section.

LEGENDS

General information and basic specifications are presented here for customers who want to do their own legends.

Suggested Printable Area for Cap

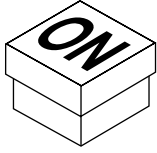

Recommended Print Method:

Screen Print or Pad Print

Epoxy based ink is recommended.

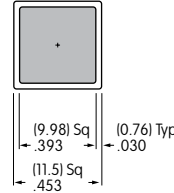

AT465

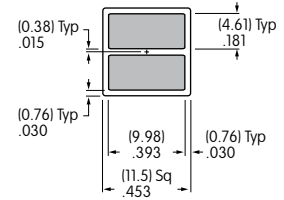

AT466

Shaded areas are printable areas.

Additional Method

An additional method for legends is engraving the cap. Maximum depth for engraving is .012" (0.3mm) on the cap. Enamel paint is recommended to fill the engraved area.

LEGEND PACKET FOR ORDERING CAPS WITH LEGENDS

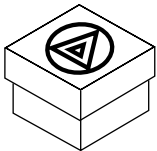

1. To order caps with legends, contact the factory and request the EB Legend Packet.
2. Once you determine your desired legend, fill out the ordering work sheet included in the packet.
3. Return the completed work sheet to receive a quotation.