

FEATURES

Stereo, 24-bit analog-to-digital and digital-to-analog converters

DAC SNR: 100 dB (A-weighted), THD: -80 dB at 48 kHz, 3.3 V

ADC SNR: 90 dB (A-weighted), THD: -80 dB at 48 kHz, 3.3 V

Stereo line inputs

Low power

7 mW stereo playback (1.8 V/1.5 V supplies)

14 mW record and playback (1.8 V/1.5 V supplies)

Low supply voltages

Analog: 1.8 V to 3.6 V

Digital: 1.5 V to 3.6 V

256/384 oversampling rate in normal mode;

250/272 oversampling rate in USB mode

Audio sampling rates: 8 kHz, 11.025 kHz, 12 kHz, 16 kHz,

22.05 kHz, 24 kHz, 32 kHz, 44.1 kHz, 48 kHz, 88.2 kHz,
and 96 kHz

20-lead, 4 mm × 4 mm LFCSP (QFN) package

APPLICATIONS

Mobile phones

MP3 players

Portable gaming

Portable electronics

Educational toys

GENERAL DESCRIPTION

The SSM2604 is a low power, high quality stereo audio codec for portable digital audio applications with one set of stereo programmable gain amplifier (PGA) line inputs. It features two 24-bit analog-to-digital converter (ADC) channels and two 24-bit digital-to-analog (DAC) converter channels.

The SSM2604 can operate as a master or a slave. It supports various master clock frequencies, including 12 MHz or 24 MHz for USB devices; standard 256 f_s or 384 f_s based rates, such as 12.288 MHz and 24.576 MHz; and many common audio sampling rates, such as 96 kHz, 88.2 kHz, 48 kHz, 44.1 kHz, 32 kHz, 24 kHz, 22.05 kHz, 16 kHz, 12 kHz, 11.025 kHz, and 8 kHz.

The SSM2604 can operate at power supplies as low as 1.8 V for the analog circuitry and as low as 1.5 V for the digital circuitry. The maximum voltage supply is 3.6 V for all supplies.

The SSM2604 is specified over the industrial temperature range of -40°C to +85°C. It is available in a 20-lead, 4 mm × 4 mm lead frame chip scale package (LFCSP).

FUNCTIONAL BLOCK DIAGRAM

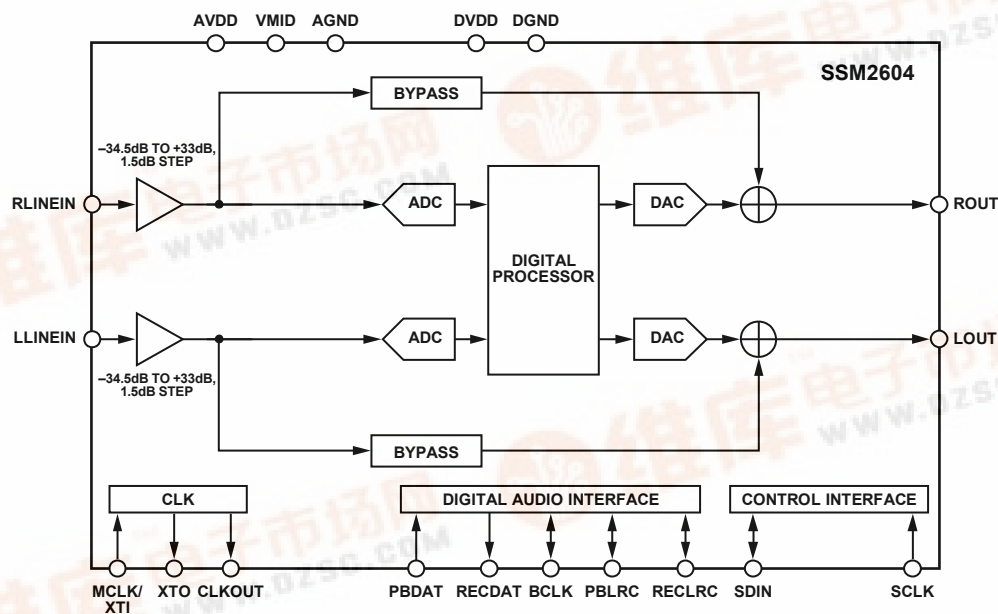

Figure 1.

06978-001

Rev. 0

Information furnished by Analog Devices is believed to be accurate and reliable. However, no responsibility is assumed by Analog Devices for its use, nor for any infringements of patents or other rights of third parties that may result from its use. Specifications subject to change without notice. No license is granted by implication or otherwise under any patent or patent rights of Analog Devices. Trademarks and registered trademarks are the property of their respective owners.

One Technology Way, P.O. Box 9106, Norwood, MA 02062-9106, U.S.A.

Tel: 781.329.4700

Fax: 781.461.3113

www.analog.com

©2008 Analog Devices, Inc. All rights reserved.



TABLE OF CONTENTS

Features	1	ADC High-Pass and DAC De-Emphasis Filters	11
Applications.....	1	Analog Interface	12
General Description	1	Digital Audio Interface	12
Functional Block Diagram	1	Software Control Interface.....	15
Revision History	2	Typical Application Circuits	16
Specifications.....	3	Register Map	17
Digital Filter Characteristics	4	Register Map Details	18
Timing Characteristics	5	Left-Channel ADC Input Volume, Address 0x00.....	18
Absolute Maximum Ratings.....	7	Right-Channel ADC Input Volume, Address 0x01	19
Thermal Resistance	7	Analog Audio Path, Address 0x04	20
ESD Caution.....	7	Digital Audio Path, Address 0x05.....	20
Pin Configuration and Function Descriptions.....	8	Power Management, Address 0x06.....	21
Typical Performance Characteristics	9	Digital Audio I/F, Address 0x07	22
Converter Filter Response.....	9	Sampling Rate, Address 0x08.....	22
Digital De-Emphasis	10	Active, Address 0x09.....	25
Theory of Operation	11	Software Reset, Address 0x0F	25
Digital Core	11	Outline Dimensions	26
ADC and DAC.....	11	Ordering Guide	26

REVISION HISTORY

7/08—Revision 0: Initial Version

SPECIFICATIONS

$T_A = 25^\circ\text{C}$, $AVDD = DVDD = 3.3\text{ V}$, 1 kHz signal, $f_s = 48\text{ kHz}$, PGA gain = 0 dB, 24-bit audio data, unless otherwise noted.

Table 1.

Parameter	Min	Typ	Max	Unit	Conditions
RECOMMENDED OPERATING CONDITIONS					
Analog Voltage Supply (AVDD)	1.8	3.3	3.6	V	
Digital Power Supply	1.5	3.3	3.6	V	
Ground (AGND, DGND)		0		V	
POWER CONSUMPTION					
Power-Up					
Stereo Record (1.5 V and 1.8 V)		7		mW	
Stereo Record (3.3 V)		22		mW	
Stereo Playback (1.5 V and 1.8 V)		7		mW	
Stereo Playback (3.3 V)		22		mW	
Power-Down		56		μW	
LINE INPUT					
Input Signal Level (0 dB)		$1 \times AVDD/3.3$		V rms	
Input Impedance		200		k Ω	PGA gain = 0 dB
		10		k Ω	PGA gain = +33 dB
		480		k Ω	PGA gain = -34.5 dB
Input Capacitance		10		pF	
Signal-to-Noise Ratio (A-Weighted)	70	90		dB	PGA gain = 0 dB, AVDD = 3.3 V
		84		dB	PGA gain = 0 dB, AVDD = 1.8 V
Total Harmonic Distortion (THD)		-80		dB	-1 dBFS input, AVDD = 3.3 V
		-75		dB	-1 dBFS input, AVDD = 1.8 V
Channel Separation		80		dB	
Programmable Gain	-34.5	0	+33.5	dB	
Gain Step		1.5		dB	
Mute Attenuation		-80		dB	
LINE OUTPUT					
DAC					-1 dBFS input DAC + line output
Full-Scale Output		$1 \times AVDD/3.3$		V rms	
Signal-to-Noise Ratio (A-Weighted)	85	100		dB	AVDD = 3.3 V
		94		dB	AVDD = 1.8 V
THD + N		-80	-75	dB	AVDD = 3.3 V
		-75		dB	AVDD = 1.8 V
Power Supply Rejection Ratio		50		dB	
Channel Separation		80		dB	
LINE INPUT TO LINE OUTPUT					
Full-Scale Output Voltage		$1 \times AVDD/3.3$		V rms	
Signal-to-Noise Ratio (A-Weighted)		92		dB	AVDD = 3.3 V
		86		dB	AVDD = 1.8 V
Total Harmonic Distortion		-80		dB	AVDD = 3.3 V
		-80		dB	AVDD = 1.8 V
Power Supply Rejection		50		dB	

DIGITAL FILTER CHARACTERISTICS

Table 2.

Parameter	Min	Typ	Max	Unit	Conditions
ADC FILTER					
Pass Band	0		0.445 f_s	Hz	± 0.04 dB
Pass-Band Ripple		0.5 f_s		Hz	-6 dB
Stop Band	0.555 f_s		± 0.04	dB	
Stop-Band Attenuation	-61			Hz	$f > 0.567 f_s$
High-Pass Filter Corner Frequency		3.7		dB	-3 dB
		10.4		Hz	-0.5 dB
		21.6		Hz	-0.1 dB
DAC FILTER					
Pass Band	0		0.445 f_s	Hz	± 0.04 dB
Pass-Band Ripple		0.5 f_s		Hz	-6 dB
Stop Band	0.555 f_s		± 0.04	dB	
Stop-Band Attenuation	-61			Hz	$f > 0.565 f_s$
CORE CLOCK TOLERANCE					
Frequency Range	8.0		13.8	MHz	
Jitter Tolerance		50		ps	

TIMING CHARACTERISTICS**Table 3. I²C Timing**

Parameter	Limit		Unit	Description
	t _{MIN}	t _{MAX}		
t _{SCS}	600		ns	Start condition setup time
t _{SCH}	600		ns	Start condition hold time
t _{PH}	600		ns	SCLK pulse width high
t _{PL}	1.3		μs	SCLK pulse width low
f _{SCLK}	0	526	kHz	SCLK frequency
t _{DS}	100		ns	Data setup time
t _{DH}		900	ns	Data hold time
t _{RT}		300	ns	SDIN and SCLK rise time
t _{FT}		300	ns	SDIN and SCLK fall time
t _{HCS}	600		ns	Stop condition setup time

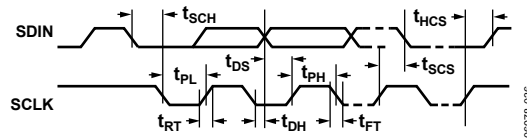
*Figure 2. I²C Timing***Table 4. Digital Audio Interface Slave Mode Timing**

Parameter	Limit		Unit	Description
	t _{MIN}	t _{MAX}		
t _{DS}	10		ns	PBDAT setup time from BCLK rising edge
t _{DH}	10		ns	PBDAT hold time from BCLK rising edge
t _{LRSU}	10		ns	RECLRC/PBLRC setup time to BCLK rising edge
t _{LRH}	10		ns	RECLRC/PBLRC hold time to BCLK rising edge
t _{DD}		30	ns	RECDAT propagation delay from BCLK falling edge (external load of 70 pF)
t _{BCH}	25		ns	BCLK pulse width high
t _{BCL}	25		ns	BCLK pulse width low
t _{BCY}	50		ns	BCLK cycle time

*Figure 3. Digital Audio Interface Slave Mode Timing*

Table 5. Digital Audio Interface Master Mode Timing

Parameter	Limit		Unit	Description
	t _{MIN}	t _{MAX}		
t _{DST}	30		ns	PBDAT setup time to BCLK rising edge
t _{DHT}	10		ns	PBDAT hold time to BCLK rising edge
t _{DL}		10	ns	RECLRC/PBLRC propagation delay from BCLK falling edge
t _{DDA}		10	ns	RECDAT propagation delay from BCLK falling edge
t _{BCLKR}	10		ns	BCLK rising time (10 pF load)
t _{BCLKF}	10		ns	BCLK falling time (10 pF load)
t _{BCLKDS}	45:55:00	55:45:00		BCLK duty cycle (normal and USB mode)

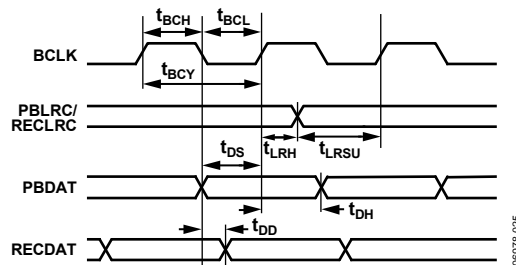
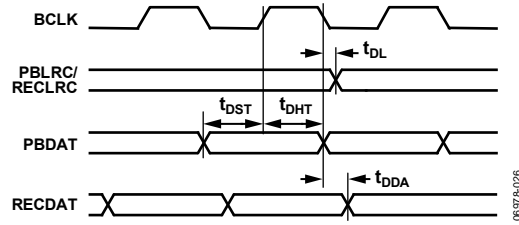

Figure 4. Digital Audio Interface Master Mode Timing

Table 6. System Clock Timing

Parameter	Limit		Unit	Description
	t _{MIN}	t _{MAX}		
t _{XTIY}	72		ns	MCLK/XTI system clock cycle time
t _{MCLKDS}	40:60	60:40:00		MCLK/XTI duty cycle
t _{XTIH}	32		ns	MCLK/XTI system clock pulse width high
t _{XTIL}	32		ns	MCLK/XTI system clock pulse width low
t _{COP}	20		ns	CLKOUT propagation delay from MCLK/XTI falling edge
t _{COPDIV2}	20		ns	CLKODIV2 propagation delay from MCLK/XTI falling edge

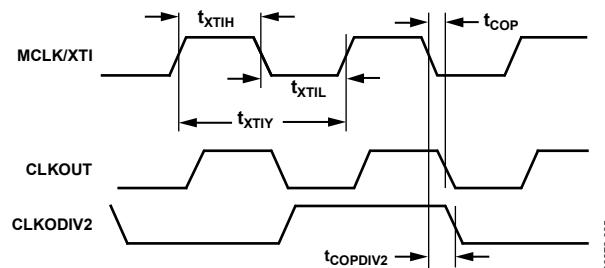

Figure 5. System (MCLK) Clock Timing

ABSOLUTE MAXIMUM RATINGS

At 25°C, unless otherwise noted.

Table 7.

Parameter	Rating
Supply Voltage	3.6 V
Input Voltage	V_{DD}
Common-Mode Input Voltage	V_{DD}
Storage Temperature Range	-65°C to +150°C
Operating Temperature Range	-40°C to +85°C
Junction Temperature Range	-65°C to +165°C
Lead Temperature (Soldering, 60 sec)	300°C

Stresses above those listed under Absolute Maximum Ratings may cause permanent damage to the device. This is a stress rating only; functional operation of the device at these or any other conditions above those indicated in the operational section of this specification is not implied. Exposure to absolute maximum rating conditions for extended periods may affect device reliability.

THERMAL RESISTANCE

θ_{JA} is specified for the worst-case conditions, that is, a device soldered in a circuit board for surface-mount packages.

Table 8. Thermal Resistance

Package Type	θ_{JA}	θ_{JC}	Unit
20-Lead, 4 mm × 4 mm LFCSP	28	32	°C/W

ESD CAUTION



ESD (electrostatic discharge) sensitive device. Charged devices and circuit boards can discharge without detection. Although this product features patented or proprietary protection circuitry, damage may occur on devices subjected to high energy ESD. Therefore, proper ESD precautions should be taken to avoid performance degradation or loss of functionality.

PIN CONFIGURATION AND FUNCTION DESCRIPTIONS

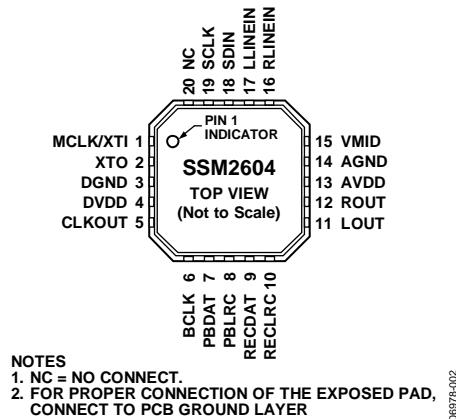

Figure 6. Pin Configuration

Table 9. Pin Function Descriptions

Pin No.	Mnemonic	Type	Description
1	MCLK/XTI	Digital Input	Master Clock Input/Crystal Input.
2	XTO	Digital Output	Crystal Output.
3	DGND	Digital Ground	Digital Ground.
4	DVDD	Digital Supply	Digital Core and I/O Buffer Supply.
5	CLKOUT	Digital Output	Buffered Clock Output.
6	BCLK	Digital Input/Output	Digital Audio Bit Clock.
7	PBDAT	Digital Input	DAC Digital Audio Data Input, Playback Function.
8	PBLRC	Digital Input/Output	DAC Sampling Rate Clock, Playback Function (from Left and Right Channels).
9	RECDAT	Digital Output	ADC Digital Audio Data Output, Record Function.
10	RECLRC	Digital Input/Output	ADC Sampling Rate Clock, Record Function (from Left and Right Channels).
11	LOUT	Analog Output	Line Output for Left Channel.
12	ROUT	Analog Output	Line Output for Right Channel.
13	AVDD	Analog Supply	Analog Supply.
14	AGND	Analog Ground	Analog Ground.
15	VMID	Analog Output	Midrail Voltage Decoupling Input.
16	RLINEIN	Analog Input	Line Input for Right Channel.
17	LLINEIN	Analog Input	Line Input for Left Channel.
18	SDIN	Digital Input/Output	2-Wire Control Interface Data Input/Output.
19	SCLK	Digital Input	2-Wire Control Interface Clock Input.
20	NC	NC	No Connection
	GND Pad	Thermal Pad/Exposed Pad	Center Thermal Pad. Connect to PCB ground layer.

TYPICAL PERFORMANCE CHARACTERISTICS

CONVERTER FILTER RESPONSE

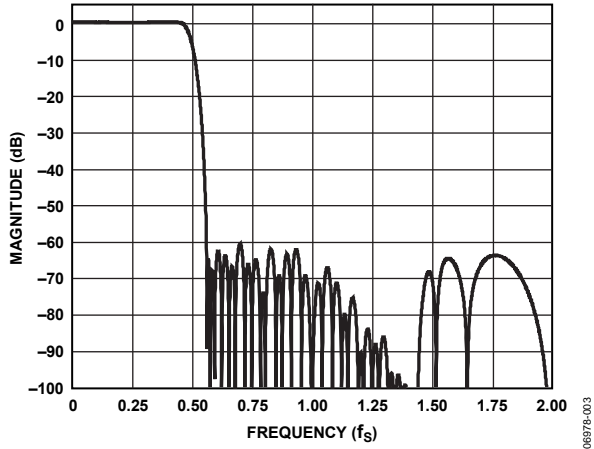

Figure 7. ADC Digital Filter Frequency Response

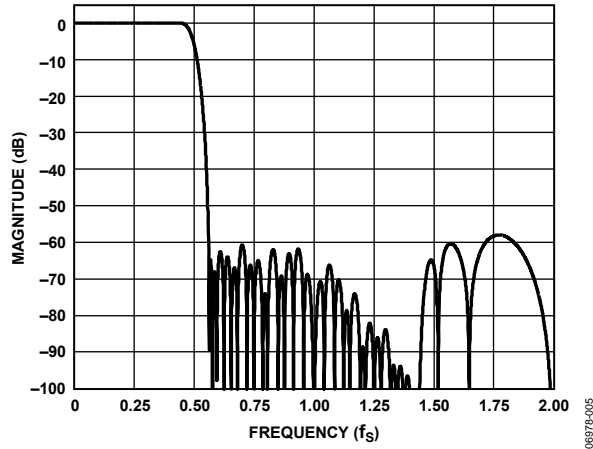

Figure 9. DAC Digital Filter Frequency Response

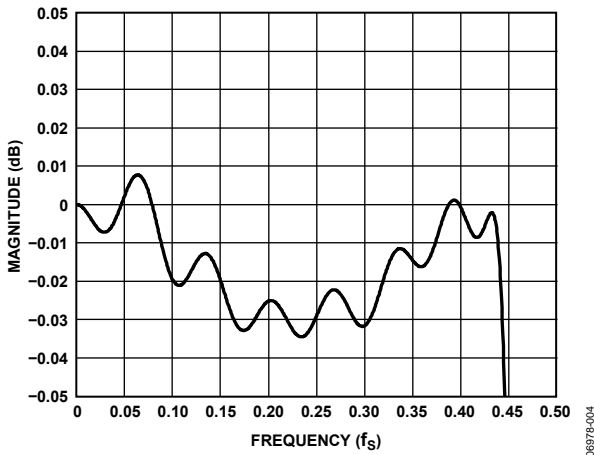

Figure 8. ADC Digital Filter Ripple

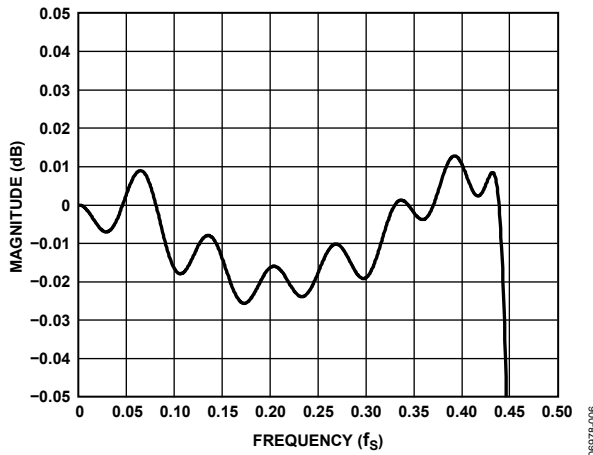

Figure 10. DAC Digital Filter Ripple

DIGITAL DE-EMPHASIS

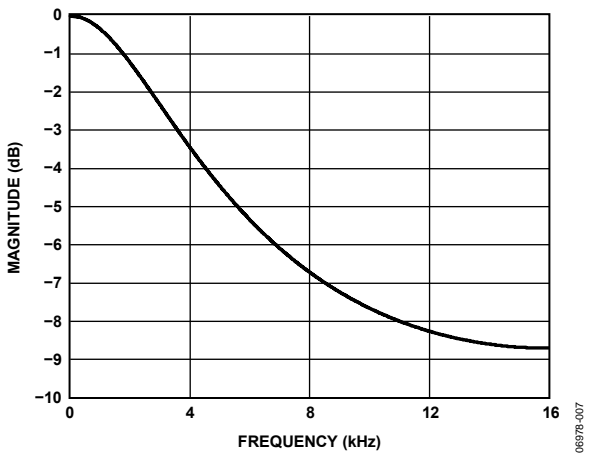

Figure 11. De-Emphasis Frequency Response, Audio Sampling Rate = 32 kHz

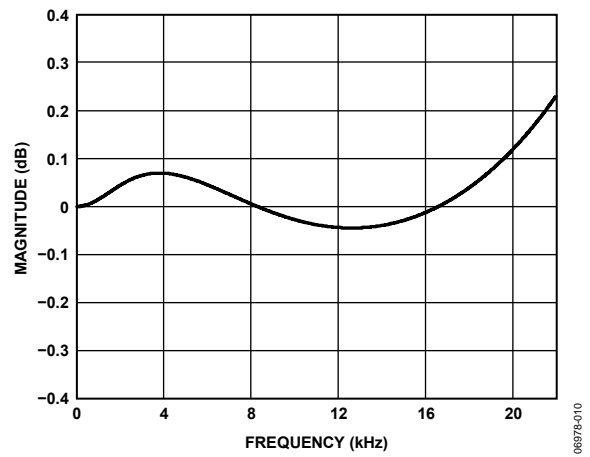

Figure 14. De-Emphasis Error, Audio Sampling Rate = 44.1 kHz

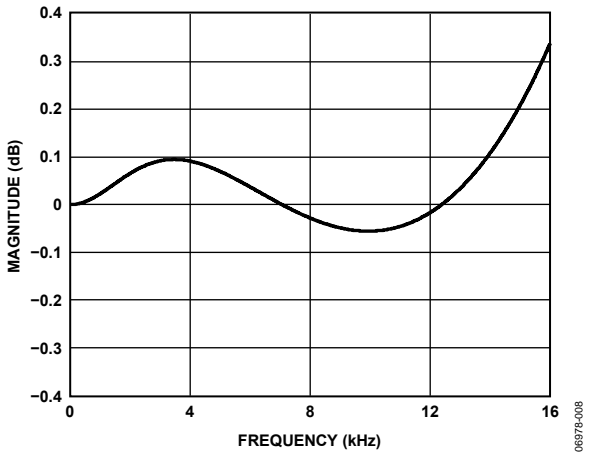

Figure 12. De-Emphasis Error, Audio Sampling Rate = 32 kHz

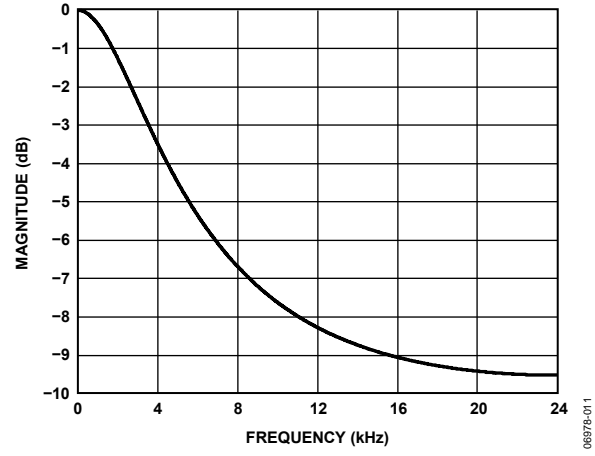

Figure 15. De-Emphasis Frequency Response, Audio Sampling Rate = 48 kHz

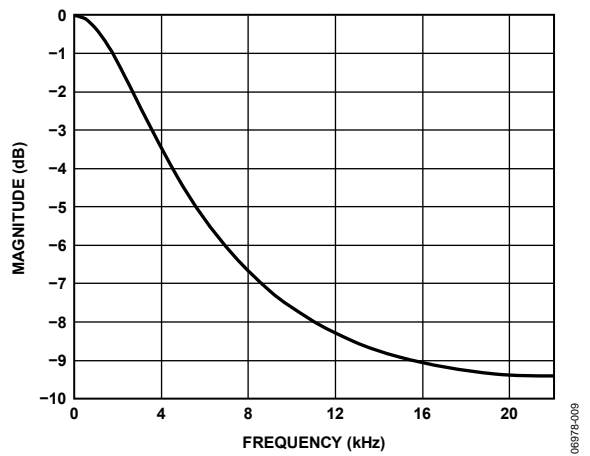

Figure 13. De-Emphasis Frequency Response, Audio Sampling Rate = 44.1 kHz

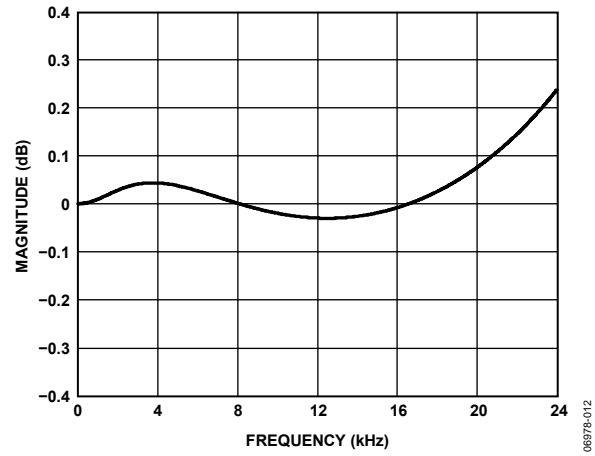

Figure 16. De-Emphasis Error, Audio Sampling Rate = 48 kHz

THEORY OF OPERATION

DIGITAL CORE

Inside the SSM2604 digital core is a central clock source, called the master clock (MCLK), that produces a reference clock for all internal audio data processing and synchronization. When using an external clock source to drive the MCLK pin, great care should be taken to select a clock source with less than 50 ps of jitter. Without careful generation of the MCLK signal, the digital audio quality likely suffers.

To enable the SSM2604 to generate the central reference clock in a system, connect a crystal oscillator between the MCLK/XTI input pin and the XTO output pin.

To allow an external device to generate the central reference clock, apply the external clock signal directly through the MCLK/XTI input pin. In this configuration, the oscillator circuit of the SSM2604 can be powered down by using the OSC bit (Register R6, Bit D5) to reduce power consumption.

To accommodate applications with very high frequency master clocks, the internal core reference clock of the SSM2604 can be set to either MCLK or MCLK divided by 2. This is enabled by adjusting the setting of the CLKDIV2 bit (Register R8, Bit D6). Complementary to this feature, the CLKOUT pin can also drive external clock sources with either the core clock signal or the core clock divided by 2 by enabling the CLKODIV2 bit (Register R8, Bit D7).

ADC AND DAC

The SSM2604 contains a pair of oversampling Σ - Δ ADCs. The maximum ADC full-scale input level is 1.0 V rms when AVDD = 3.3 V. If the input signal to the ADC exceeds this level, data overloading occurs and causes audible distortion.

The ADC accepts analog audio input from the stereo line inputs. The digital data from the ADC output, once converted, is processed using the ADC filters.

Complementary to the ADC channels, the SSM2604 contains a pair of oversampling Σ - Δ DACs that convert the digital audio data from the internal DAC filters into an analog audio signal. The DAC output can also be muted by setting the DACMU bit (Register R5, Bit D3) in the control register.

ADC HIGH-PASS AND DAC DE-EMPHASIS FILTERS

The ADC and DAC employ separate digital filters that perform 24-bit signal processing. The digital filters are used for both record and playback modes and are optimized for each individual sampling rate used.

For recording mode operations, the unprocessed data from the ADC enters the ADC filters and is converted to the appropriate sampling frequency, and then is output to the digital audio interface.

For playback mode operations, the DAC filters convert the digital audio interface data to oversampled data, using a sampling rate selected by the user. The oversampled data is processed by the DAC and then is sent to the analog output mixer by enabling the DACSEL (Register R4, Bit D4).

Users have the option of setting up the device so that any dc offset in the input source signal is automatically detected and removed. To accomplish this, enable the digital high-pass filter (see Table 2 for characteristics) contained in the ADC digital filters by using the ADCHPF bit (Register R5, Bit D0).

In addition, users can implement digital de-emphasis by using the DEEMPH bits (Register R5, Bit D1 and Bit D2).

ANALOG INTERFACE

Signal Chain

The SSM2604 includes stereo single-ended line inputs to the on-board ADC. In addition, the line inputs can be routed and mixed directly to the output terminals via the BYPASS bit (Register R4, Bit D3). The SSM2604 also includes line outputs from the on-board DAC.

Stereo Line Inputs

The SSM2604 contains a set of single-ended stereo line inputs (RLINEIN and LLINEIN) that are internally biased to VMID by way of a voltage divider between AVDD and AGND. The line input signal can be connected to the internal ADC and, if desired, routed directly to the outputs via the bypass path by using the BYPASS bit (Register R4, Bit D3).

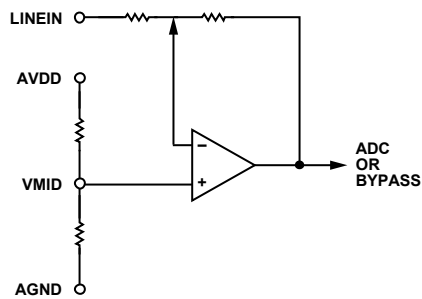

Figure 17. Line Input to ADC

The line input volume can be adjusted from -34.5 dB to $+33$ dB in steps of $+1.5$ dB by setting the LINVOL (Register R0, Bit D0 to Bit D5) and RINVOL (Register R1, Bit D0 to Bit D5) bits. Volume control, by default, is independently adjustable on both right and left line inputs. However, the LRINBOTH or RLINBOTH bit, if selected, simultaneously loads both sets of volume control with the same value. The user can also set the LINMUTE (Register R0, Bit D7) and RINMUTE (Register R1, Bit D7) bits to mute the line input signal to the ADC.

Note that when sourcing audio data from line inputs, the maximum full-scale input of the ADC is 1.0 V rms when $AVDD = 3.3$ V. Do not source any input voltage larger than full scale to avoid overloading the ADC, which causes distortion of sound and deterioration of audio quality. For best sound quality in line inputs, gain should be carefully configured so that the ADC receives a signal equal to its full scale. This maximizes the signal-to-noise ratio for best total audio quality.

Bypass Path to Output

The line inputs can be routed and mixed directly to the output terminals via the BYPASS (Register R4, Bit D3) software control register selection. The analog input signal is routed directly to the output terminals and is not digitally converted. The bypass signal at the output mixer is the same level as the output of the PGA associated with each line input.

Line Outputs

The DAC outputs and the line inputs (the bypass path) are summed at an output mixer.

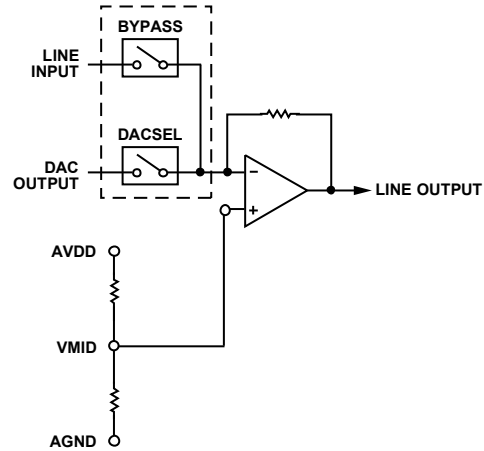

Figure 18. Output Signal Chain

The maximum output level of the line outputs is 1.0 V rms when $AVDD$ and $HPVDD = 3.3$ V. To suppress audible pops and clicks, the line outputs are held at the VMID dc voltage level when the device is set to standby mode.

The stereo line outputs of the SSM2604, the LOUT and ROUT pins, are able to drive a load impedance of 10 k Ω and 50 pF. The line output signal levels are not adjustable at the output mixer, having a fixed gain of 0 dB.

DIGITAL AUDIO INTERFACE

The digital audio input can support the following four digital audio communication protocols: right-justified mode, left-justified mode, I²S mode, and digital signal processor (DSP) mode.

The mode selection is performed by writing to the FORMAT bits of the digital audio interface register (Register R7, Bit D1 and Bit D0). All modes are MSB first and operate with data of 16 to 32 bits.

Recording Mode

On the RECDAT output pin, the digital audio interface can send digital audio data for recording mode operation. The digital audio interface outputs the processed internal ADC digital filter data onto the RECDAT output. The digital audio data stream on RECDAT comprises left- and right-channel audio data that is time domain multiplexed.

The RECLRC is the digital audio frame clock signal that separates left- and right-channel data on the RECDAT lines.

The BCLK signal acts as the digital audio clock. Depending on if the SSM2604 is in master or slave mode, the BCLK signal is either an input or an output signal. During a recording operation, RECDAT and RECLRC must be synchronous to the BCLK signal to avoid data corruption.

Playback Mode

On the PBDAT input pin, the digital audio interface can receive digital audio data for playback mode operation. The digital audio data stream on PBDAT comprises left- and right-channel audio data that is time domain multiplexed. The PBLRC is the digital

audio frame clock signal that separates left- and right-channel data on the PBDAT lines.

The BCLK signal acts as the digital audio clock. Depending on if the SSM2604 is in master or slave mode, the BCLK signal is either an input or an output signal. During a playback operation, PBDAT and PBLRC must be synchronous to the BCLK signal to avoid data corruption.

Digital Audio Data Sampling Rate

To accommodate a wide variety of commonly used DAC and ADC sampling rates, the SSM2604 allows for two modes of operation, normal and USB, selected by the USB bit (Register R8, Bit D0).

In normal mode, the SSM2604 supports digital audio sampling rates from 8 kHz to 96 kHz. Normal mode supports 256 f_s and 384 f_s based clocks. To select the desired sampling rate, the user must set the appropriate sampling rate register in the SR control bits (Register R8, Bit D2 to Bit D5) and match this selection to the core clock frequency that is pulsed on the MCLK pin. See Table 25 and Table 26 for guidelines.

In USB mode, the SSM2604 supports digital audio sampling rates from 8 kHz to 96 kHz. USB mode is enabled on the

SSM2604 to support the common universal serial bus (USB) clock rate of 12 MHz, or to support 24 MHz if the CLKDIV2 control register bit is activated. The user must set the appropriate sampling rate in the SR control bits (Register R8, Bit D2 to Bit D5). See Table 25 and Table 26 for guidelines.

Note that the sampling rate is generated as a fixed divider from the MCLK signal. Because all audio processing references the core MCLK signal, corruption of this signal, in turn, corrupts the outgoing audio quality of the SSM2604. The BCLK/RECLRC/RECDAT or BCLK/PBLRC/PBDAT signals must be synchronized with MCLK in the digital audio interface circuit. MCLK must be faster or equal to the BCLK frequency to guarantee that no data is lost during data synchronization.

The BCLK frequency should be greater than

$$\text{Sampling Rate} \times \text{Word Length} \times 2$$

Ensuring that the BCLK frequency is greater than this value guarantees that all valid data bits are captured by the digital audio interface circuitry. For example, if a 32 kHz digital audio sampling rate with a 32-bit word length is desired, $BCLK \geq 2.048 \text{ MHz}$.

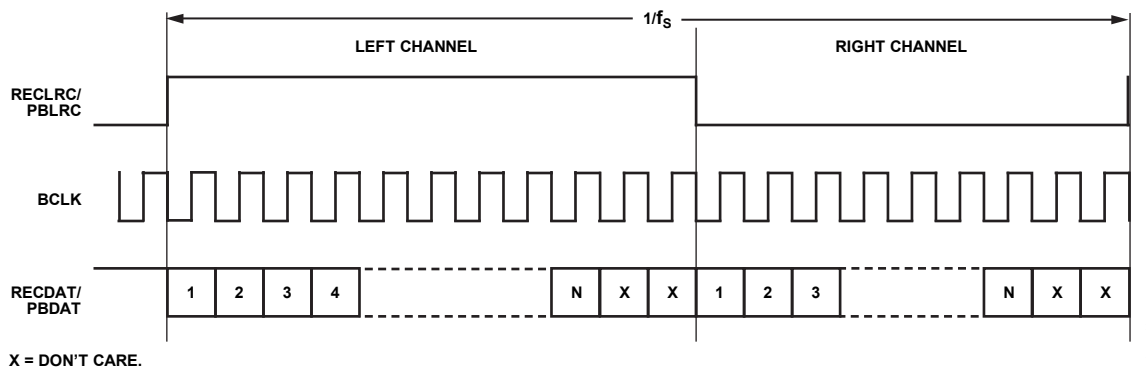

Figure 19. Left-Justified Audio Input Mode

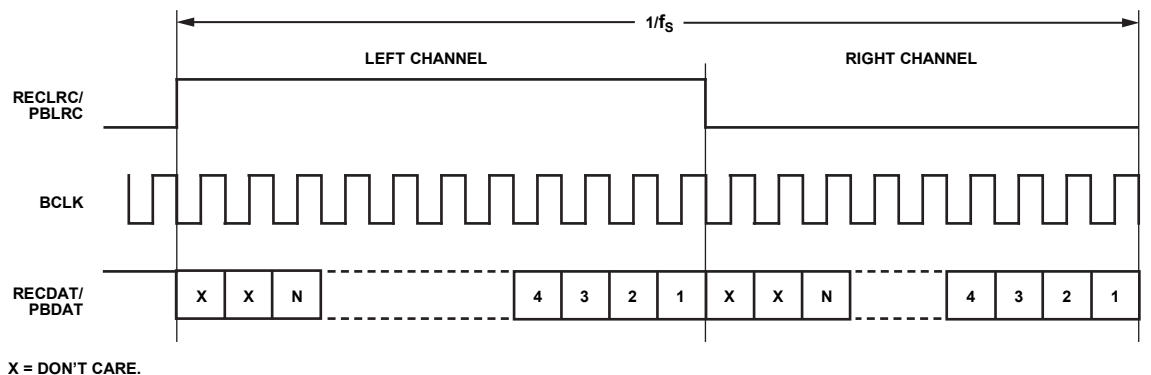

Figure 20. Right-Justified Audio Input Mode

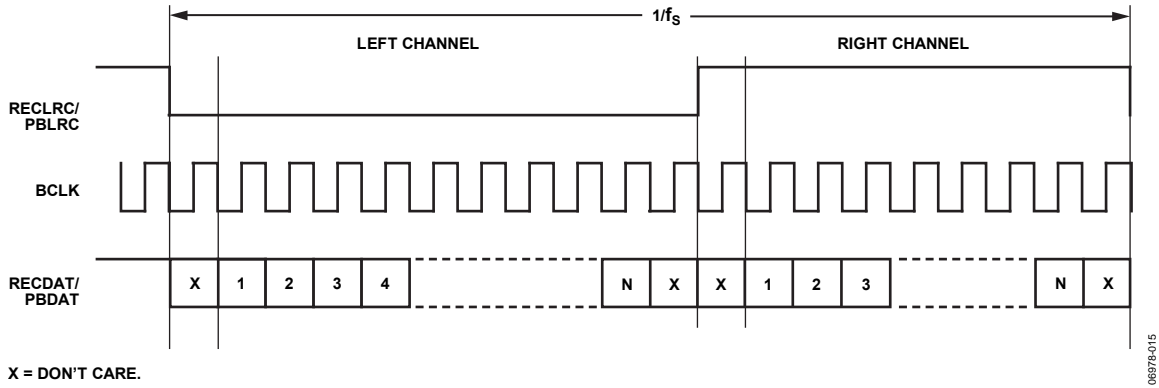

Figure 21. PS Audio Input Mode

06578-015

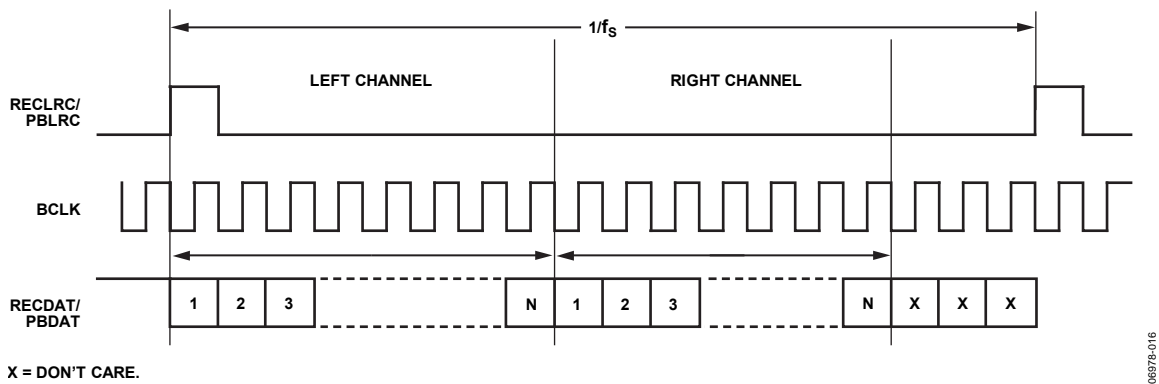

Figure 22. DSP/Pulse Code Modulation (PCM) Mode Audio Input Submode 1 (SM1) [Bit LRP = 0]

06578-016

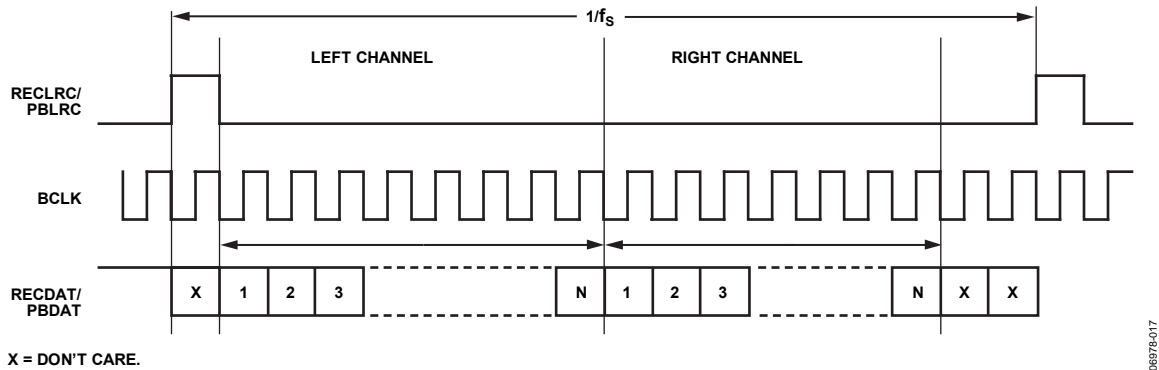

Figure 23. DSP/PCM Mode Audio Input Submode 2 (SM2) [Bit LRP = 1]

06578-017

SOFTWARE CONTROL INTERFACE

The software control interface provides access to the user-selectable control registers and can operate with a 2-wire (I²C[®]) interface.

Within each control register is a control data-word consisting of 16 bits, MSB first. Bit D15 to Bit D9 are the register map

address, and Bit D8 to Bit D0 are register data for the associated register map.

SDIN generates the serial control data-word; SCLK clocks the serial data,

The device address for the SSM2604 is 0011010.

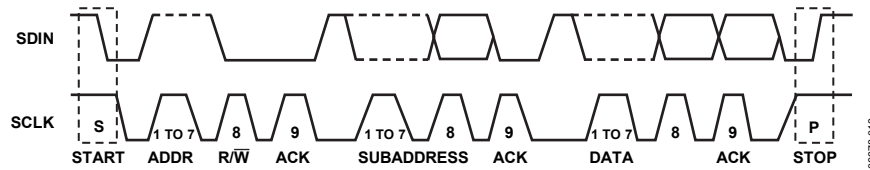
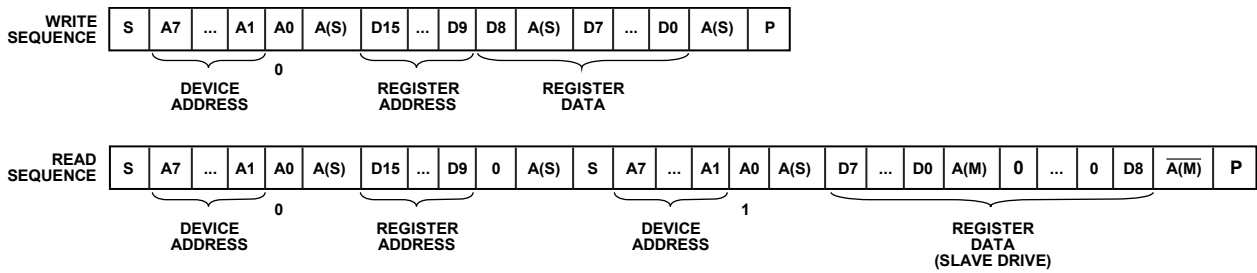

Figure 24. 2-Wire I²C Generalized Clocking Diagram



S/P = START/STOP BIT.
 A0 = I²C R/W BIT.
 A(S) = ACKNOWLEDGE BY SLAVE.
 A(M) = ACKNOWLEDGE BY MASTER.
 A(M) = ACKNOWLEDGE BY MASTER (INVERSION).

Figure 25. I²C Write and Read Sequences

TYPICAL APPLICATION CIRCUITS

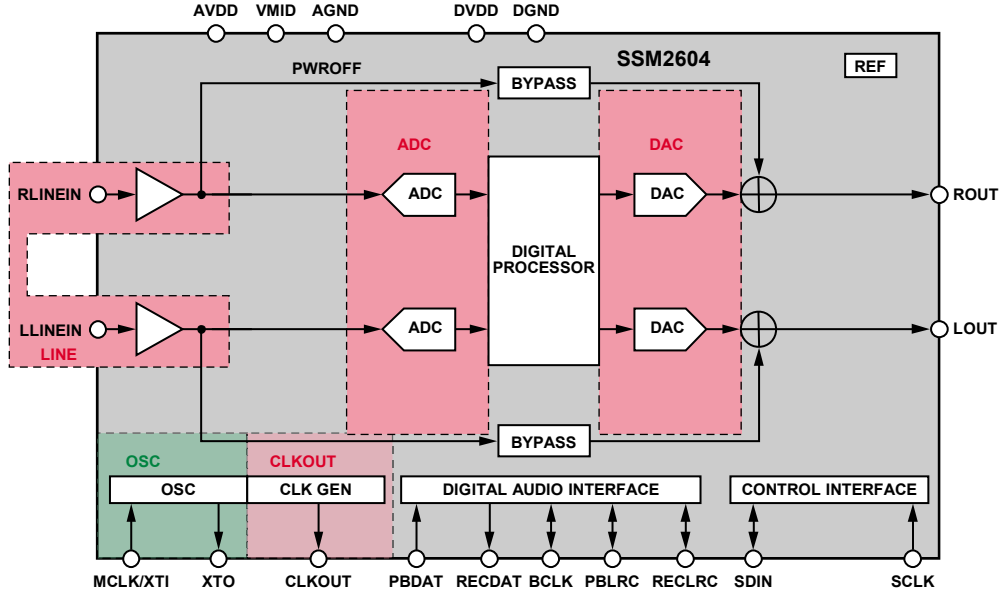

Figure 26. Power Management Functional Location Diagram (Control Register R6, Bit D0 to Bit D7)

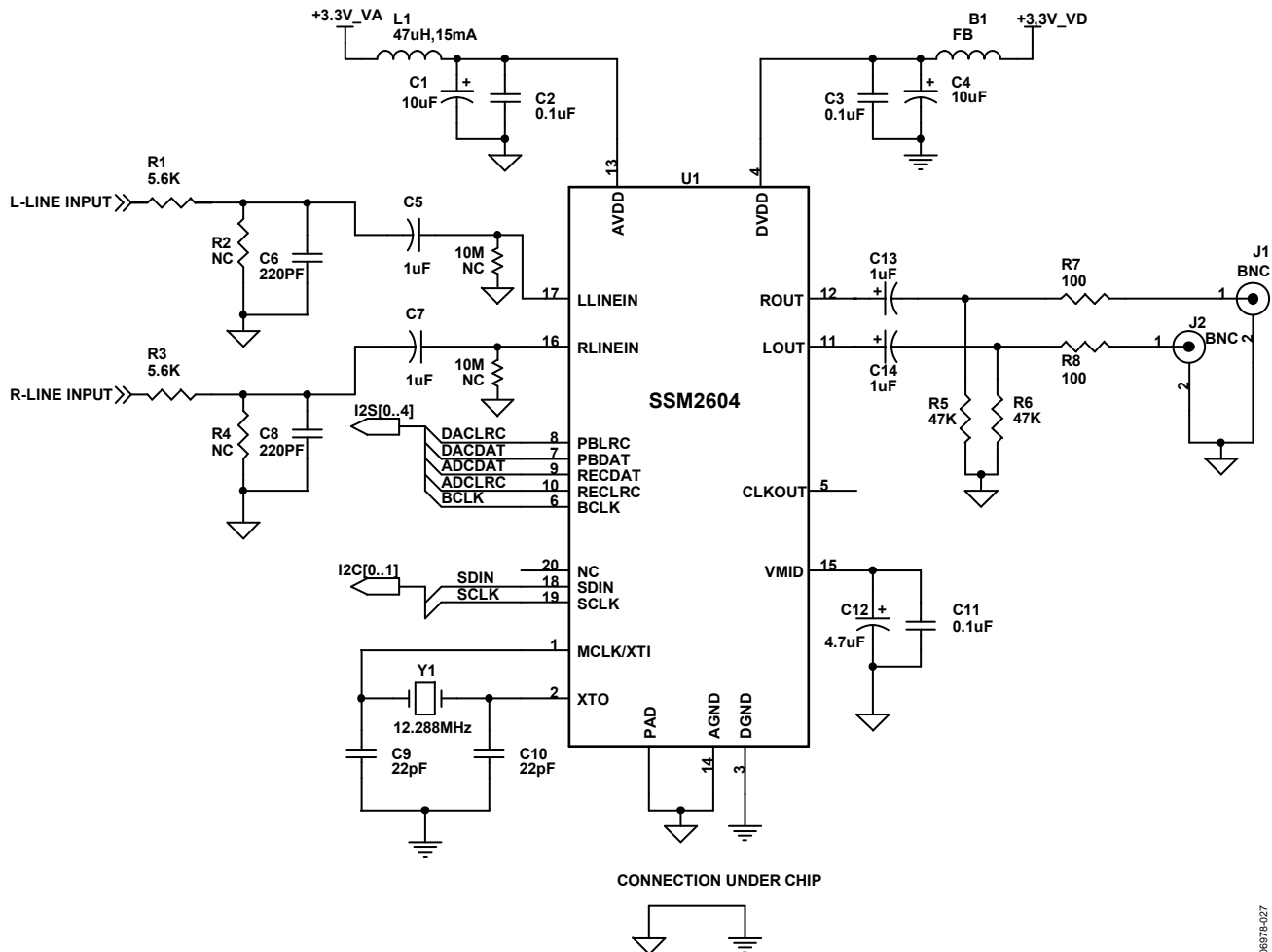

Figure 27. Typical Application Circuit

REGISTER MAP

Table 10. Register Map

Reg.	Address	Name	D8	D7	D6	D5	D4	D3	D2	D1	D0	Default
R0	0x00	Left-Channel ADC Input Volume	LRINBOTH	LINMUTE	0	LINVOL [5:0]						010010111
R1	0x01	Right-Channel ADC Input Volume	RLINBOTH	RINMUTE	0	RINVOL [5:0]						010010111
R2	0x02	Reserved	0	0	0	0	0	0	0	0	0	000000000
R3	0x03	Reserved	0	0	0	0	0	0	0	0	0	000000000
R4	0x04	Analog Audio Path	0	0	0	0	DACSEL	BYPASS	0	0	0	000001000
R5	0x05	Digital Audio Path	0	0	0	0	HPOR	DACMU	DEEMPH [1:0]		ADCHPF	000001000
R6	0x06	Power Management	0	PWROFF	CLKOUT	OSC	1	DAC	ADC	1	LINEIN	010011111
R7	0x07	Digital Audio I/F	0	BCLKINV	MS	LRSWAP	LRP	WL [1:0]		FORMAT [1:0]		000001010
R8	0x08	Sampling Rate	0	CLKODIV2	CLKDIV2	SR [3:0]				BOSR	USB	000000000
R9	0x09	Active	0	0	0	0	0	0	0	0	ACTIVE	000000000
R15	0x0F	Software Reset	RESET [8:0]									000000000

REGISTER MAP DETAILS

LEFT-CHANNEL ADC INPUT VOLUME, ADDRESS 0x00

Table 11. Left-Channel ADC Input Volume Register Bit Map

D8	D7	D6	D5	D4	D3	D2	D1	D0
LRINBOTH	LINMUTE	0	LINVOL [5:0]					

Table 12. Descriptions of Left-Channel ADC Input Volume Register Bits

Bit Name	Description	Settings
LRINBOTH	Left-to-right line input ADC data load control	0 = disable simultaneous loading of left-channel ADC data to right-channel register (default) 1 = enable simultaneous loading of left-channel ADC data to right-channel register
LINMUTE	Left-channel input mute	0 = disable mute 1 = enable mute on data path to ADC (default)
LINVOL [5:0]	Left-channel PGA volume control	00 0000 = -34.5 dB ... 1.5 dB step up 01 0111 = 0 dB (default) ... 1.5 dB step up 01 1111 = 12 dB 10 0000 = 13.5 dB 10 0001 = 15 dB 10 0010 = 16.5 dB 10 0011 = 18 dB 10 0100 = 19.5 dB 10 0101 = 21 dB 10 0110 = 22.5 dB 10 0111 = 24 dB 10 1000 = 25.5 dB 10 1001 = 27 dB 10 1010 = 28.5 dB 10 1011 = 30 dB 10 1100 = 31.5 dB 10 1101 = 33 dB 11 1111 to 10 1101 = 33 dB

RIGHT-CHANNEL ADC INPUT VOLUME, ADDRESS 0x01

Table 13. Right-Channel ADC Input Volume Register Bit Map

D8	D7	D6	D5	D4	D3	D2	D1	D0
RLINBOTH	RINMUTE	0	RINVOL [5:0]					

Table 14. Descriptions of Right-Channel ADC Input Volume Register Bits

Bit Name	Description	Settings
RLINBOTH	Right-to-left line input ADC data load control	0 = disable simultaneous loading of right-channel ADC data to left-channel register (default) 1 = enable simultaneous loading of right-channel ADC data to left-channel register
RINMUTE	Right-channel input mute	0 = disable mute 1 = enable mute on data path to ADC (default)
RINVOL [5:0]	Right-channel PGA volume control	00 0000 = -34.5 dB ... 1.5 dB step up 01 0111 = 0 dB (default) ... 1.5 dB step up 01 1111 = 12 dB 10 0000 = 13.5 dB 10 0001 = 15 dB 10 0010 = 16.5 dB 10 0011 = 18 dB 10 0100 = 19.5 dB 10 0101 = 21 dB 10 0110 = 22.5 dB 10 0111 = 24 dB 10 1000 = 25.5 dB 10 1001 = 27 dB 10 1010 = 28.5 dB 10 1011 = 30 dB 10 1100 = 31.5 dB 10 1101 = 33 dB 11 1111 to 10 1101 = 33 dB

ANALOG AUDIO PATH, ADDRESS 0x04

Table 15. Analog Audio Path Register Bit Map

D8	D7	D6	D5	D4	D3	D2	D1	D0
0	0	0	0	DACSEL	BYPASS	0	0	0

Table 16. Descriptions of Analog Audio Path Register Bits

Bit Name	Description	Settings
DACSEL	DAC select. Allow DAC output to be mixed at device output terminal.	0 = do not select DAC (default)
BYPASS	Bypass select. Allow line input signal to be mixed at device output terminal.	0 = bypass disable

DIGITAL AUDIO PATH, ADDRESS 0x05

Table 17. Digital Audio Path Register Bit Map

D8	D7	D6	D5	D4	D3	D2	D1	D0
0	0	0	0	HPOR	DACMU	DEEMPH [1:0]		ADCHPF

Table 18. Descriptions of Digital Audio Path Register Bits

Bit Name	Description	Settings
HPOR	Store dc offset when high-pass filter is disabled	0 = clear offset (default) 1 = store offset
DACMU	DAC digital mute	0 = no mute (signal active) 1 = mute (default)
DEEMPH [1:0]	De-emphasis control	00 = no de-emphasis (default) 01 = 32 kHz sampling rate 10 = 44.1 kHz sampling rate 11 = 48 kHz sampling rate
ADCHPF	ADC high-pass filter control	0 = ADC high-pass filter enable (default) 1 = ADC high-pass filter disable

POWER MANAGEMENT, ADDRESS 0x06

Table 19. Power Management Register Bit Map

D8	D7	D6	D5	D4	D3	D2	D1	D0
0	PWROFF	CLKOUT	OSC	1	DAC	ADC	1	LINEIN

Table 20. Description of Power Management Register Bits

Bit Name	Description	Settings
PWROFF	Whole chip power-down control	0 = power up 1 = power down (default)
CLKOUT	Clock output power-down control	0 = power up (default) 1 = power down
OSC	Crystal power-down control	0 = power up (default) 1 = power down
DAC	DAC power-down control	0 = power up 1 = power down (default)
ADC	ADC power-down control	0 = power up 1 = power down (default)
LINEIN	Line input power-down control	0 = power up 1 = power down (default)

Power Consumption

Table 21.

Mode	PWROFF	CLKOUT	OSC	DAC	ADC	LINEIN	AVDD (3.3 V)	DVDD (3.3 V)	Unit
Record and Playback	0	0	0	0	0	0	9.41	3.7	mA
Playback Only									
Oscillator Enabled	0	0	0	0	1	1	4.45	1.9	mA
External Clock	0	1	1	0	1	1	4.56	1.9	mA
Record Only									
Line Clock	0	0	0	1	0	0	4.31	2.0	mA
Line Oscillator	0	0	1	1	0	0	4.33	2.0	mA
Analog Bypass (Line Input or Line Output)									
External Line	0	0	1	1	1	0	1.88	0.21	mA
Internally Generated Line	0	0	1	1	1	0	1.88	0.25	mA
Power-Down									
External Clock	1	1	1	1	1	1	0.002	0.015	mA
Oscillator	1	1	1	1	1	1	0.002	0.015	mA

DIGITAL AUDIO I/F, ADDRESS 0x07

Table 22. Digital Audio I/F Register Bit Map

D8	D7	D6	D5	D4	D3	D2	D1	D0
0	BCLKINV	MS	LRSWAP	LRP	WL [1:0]		FORMAT [1:0]	

Table 23. Descriptions of Digital Audio I/F Register Bits

Bit Name	Description	Settings
BCLKINV	BCLK inversion control	0 = BCLK not inverted (default) 1 = BCLK inverted
MS	Master mode enable	0 = enable slave mode (default) 1 = enable master mode
LRSWAP	Swap DAC data control	0 = output left- and right-channel data as normal (default) 1 = swap left- and right-channel DAC data in audio interface
LRP	Polarity control for clocks in right-justified, left-justified, and I ² S modes	0 = normal PBLRC and RECLRC (default), or DSP Submode 1 1 = invert PBLRC and RECLRC polarity, or DSP Submode 2
WL [1:0]	Data-word length control	00 = 16 bits 01 = 20 bits 10 = 24 bits (default) 11 = 32 bits
FORMAT [1:0]	Digital audio input format control	00 = right justified 01 = left justified 10 = I ² S mode (default) 11 = DSP mode

SAMPLING RATE, ADDRESS 0x08

Table 24. Sampling Rate Register Bit Map

D8	D7	D6	D5	D4	D3	D2	D1	D0
0	CLKODIV2	CLKDIV2	SR [3:0]				BOSR	USB

Table 25. Descriptions of Sampling Rate Register Bits

Bit Name	Description	Settings
CLKODIV2	CLKOUT divider select	0 = CLKOUT is core clock (default) 1 = CLKOUT is core clock divided by 2
CLKDIV2	Core clock divide select	0 = core clock is MCLK (default) 1 = core clock is MCLK divided by 2
SR [3:0]	Clock setting condition	See Table 26 and Table 27
BOSR	Base oversampling rate	USB mode: 0 = support for 250 f _s based clock (default) 1 = support for 272 f _s based clock Normal mode: 0 = support for 256 f _s based clock (default) 1 = support for 384 f _s based clock
USB	USB mode select	0 = normal mode enable (default) 1 = USB mode enable

Table 26. Sampling Rate Lookup Table, USB Disabled (Normal Mode)

MCLK (CLKDIV2 = 0)	MCLK (CLKDIV2 = 1)	ADC Sampling Rate (RECLRC)	DAC Sampling Rate (PBLRC)	USB	SR [3:0]	BOSR	BCLK (MS = 1) ¹
12.288 MHz	24.576 MHz	8 kHz (MCLK/1536)	8 kHz (MCLK/1536)	0	0011	0	MCLK/4
		8 kHz (MCLK/1536)	48 kHz (MCLK/256)	0	0010	0	MCLK/4
		12 kHz (MCLK/1024)	12 kHz (MCLK/1024)	0	0100	0	MCLK/4
		16 kHz (MCLK/768)	16 kHz (MCLK/768)	0	0101	0	MCLK/4
		24 kHz (MCLK/512)	24 kHz (MCLK/512)	0	1110	0	MCLK/4
		32 kHz (MCLK/384)	32 kHz (MCLK/384)	0	0110	0	MCLK/4
		48 kHz (MCLK/256)	8 kHz (MCLK/1536)	0	0001	0	MCLK/4
		48 kHz (MCLK/256)	48 kHz (MCLK/256)	0	0000	0	MCLK/4
		96 kHz (MCLK/128)	96 kHz (MCLK/128)	0	0111	0	MCLK/2
11.2896 MHz	22.5792 MHz	8.0182 kHz (MCLK/1408)	8.0182 kHz (MCLK/1408)	0	1011	0	MCLK/4
		8.0182 kHz (MCLK/1408)	44.1 kHz (MCLK/256)	0	1010	0	MCLK/4
		11.025 kHz (MCLK/1024)	11.025 kHz (MCLK/1024)	0	1100	0	MCLK/4
		22.05 kHz (MCLK/512)	22.05 kHz (MCLK/512)	0	1101	0	MCLK/4
		44.1 kHz (MCLK/256)	8.0182 kHz (MCLK/1408)	0	1001	0	MCLK/4
		44.1 kHz (MCLK/256)	44.1 kHz (MCLK/256)	0	1000	0	MCLK/4
		88.2 kHz (MCLK/128)	88.2 kHz (MCLK/128)	0	1111	0	MCLK/2
18.432 MHz	36.864 MHz	8 kHz (MCLK/2304)	8 kHz (MCLK/2304)	0	0011	1	MCLK/6
		8 kHz (MCLK/2304)	48 kHz (MCLK/384)	0	0010	1	MCLK/6
		12 kHz (MCLK/1536)	12 kHz (MCLK/1536)	0	0100	1	MCLK/6
		16 kHz (MCLK/1152)	16 kHz (MCLK/1152)	0	0101	1	MCLK/6
		24 kHz (MCLK/768)	24 kHz (MCLK/768)	0	1110	1	MCLK/6
		32 kHz (MCLK/576)	32 kHz (MCLK/576)	0	0110	1	MCLK/6
		48 kHz (MCLK/384)	48 kHz (MCLK/384)	0	0000	1	MCLK/6
		48 kHz (MCLK/384)	8 kHz (MCLK/2304)	0	0001	1	MCLK/6
		96 kHz (MCLK/192)	96 kHz (MCLK/192)	0	0111	1	MCLK/3
16.9344 MHz	33.8688 MHz	8.0182 kHz (MCLK/2112)	8.0182 kHz (MCLK/2112)	0	1011	1	MCLK/6
		8.0182 kHz (MCLK/2112)	44.1 kHz (MCLK/384)	0	1010	1	MCLK/6
		11.025 kHz (MCLK/1536)	11.025 kHz (MCLK/1536)	0	1100	1	MCLK/6
		22.05 kHz (MCLK/768)	22.05 kHz (MCLK/768)	0	1101	1	MCLK/6
		44.1 kHz (MCLK/384)	8.0182 kHz (MCLK/2112)	0	1001	1	MCLK/6
		44.1 kHz (MCLK/384)	44.1 kHz (MCLK/384)	0	1000	1	MCLK/6
		88.2 kHz (MCLK/192)	88.2 kHz (MCLK/192)	0	1111	1	MCLK/3

¹ BCLK frequency is for master mode and slave right-justified mode only.

SSM2604

[查询"SSM2604"供应商](#)

Table 27. Sampling Rate Lookup Table, USB Enabled (USB Mode)

MCLK (CLKDIV2 = 0)	MCLK (CLKDIV2 = 1)	ADC Sampling Rate (RECLRC)	DAC Sampling Rate (PBLRC)	USB	SR [3:0]	BOSR	BCLK (MS = 1) ¹
12.000 MHz	24.000 MHz	8 kHz (MCLK/1500)	8 kHz (MCLK/1500)	1	0011	0	MCLK
		8 kHz (MCLK/1500)	48 kHz (MCLK/250)	1	0010	0	MCLK
		8.0214 kHz (MCLK/1496)	8.0214 kHz (MCLK/1496)	1	1011	1	MCLK
		8.0214 kHz (MCLK/1496)	44.118 kHz (MCLK/272)	1	1010	1	MCLK
		11.0259 kHz (MCLK/1088)	11.0259 kHz (MCLK/1088)	1	1100	1	MCLK
		12 kHz (MCLK/1000)	12 kHz (MCLK/1000)	1	1000	0	MCLK
		16 kHz (MCLK/750)	16 kHz (MCLK/750)	1	1010	0	MCLK
		22.0588 kHz (MCLK/544)	22.0588 kHz (MCLK/544)	1	1101	1	MCLK
		24 kHz (MCLK/500)	24 kHz (MCLK/500)	1	1110	0	MCLK
		32 kHz (MCLK/375)	32 kHz (MCLK/375)	1	0110	0	MCLK
		44.118 kHz (MCLK/272)	8.0214 kHz (MCLK/1496)	1	1001	1	MCLK
		44.118 kHz (MCLK/272)	44.118 kHz (MCLK/272)	1	1000	1	MCLK
		48 kHz (MCLK/250)	8 kHz (MCLK/1500)	1	0001	0	MCLK
		48 kHz (MCLK/250)	48 kHz (MCLK/250)	1	0000	0	MCLK
		88.235 kHz (MCLK/136)	88.235 kHz (MCLK/136)	1	1111	1	MCLK
96 kHz (MCLK/125)	96 kHz (MCLK/125)	1	0111	0	MCLK		

¹ BCLK frequency is for master mode and slave right-justified mode only.

[查询"SSM2604"供应商](#)

ACTIVE, ADDRESS 0x09

Table 28. Active Register Bit Map

D8	D7	D6	D5	D4	D3	D2	D1	D0
0	0	0	0	0	0	0	0	ACTIVE

Table 29. Descriptions of Active Register Bit

Bit Name	Description	Settings
ACTIVE	Digital core activation control	0 = disable digital core (default) 1 = activate digital core

SOFTWARE RESET, ADDRESS 0x0F

Table 30. Software Reset Register Bit Map

D8	D7	D6	D5	D4	D3	D2	D1	D0
RESET [8:0]								

Table 31. Descriptions of Software Reset Register Bits

Bit Name	Description	Settings
RESET [8:0]	Write all 0s to this register to set all registers to their default settings. Other data written to this register has no effect.	0 = reset (default)

OUTLINE DIMENSIONS

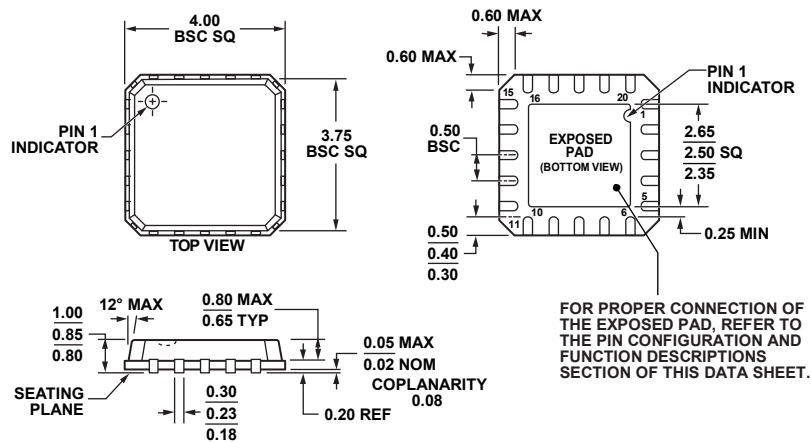

COMPLIANT TO JEDEC STANDARDS MO-220-VGGD-1

Figure 28. 20-Lead Lead Frame Chip Scale Package [LFCSP_VQ]
 4 mm × 4 mm Body, Very Thin Quad
 (CP-20-4)
 Dimensions shown in millimeters

071800-B

ORDERING GUIDE

Model	Temperature Range	Package Description	Package Option
SSM2604CPZ-R2 ¹	-40°C to +85°C	20-Lead Lead Frame Chip Scale Package [LFCSP_VQ]	CP-20-4
SSM2604CPZ-REEL ¹	-40°C to +85°C	20-Lead Lead Frame Chip Scale Package [LFCSP_VQ]	CP-20-4
SSM2604CPZ-REEL7 ¹	-40°C to +85°C	20-Lead Lead Frame Chip Scale Package [LFCSP_VQ]	CP-20-4
SSM2604-EVALZ ¹		Evaluation Board	

¹ Z = RoHS Compliant Part.

NOTES

SSM2604

[查询"SSM2604"供应商](#)

NOTES